

# SmartNode 4520 & 4110 Series **VoIP Gateway Routers**

---

## *User Manual*

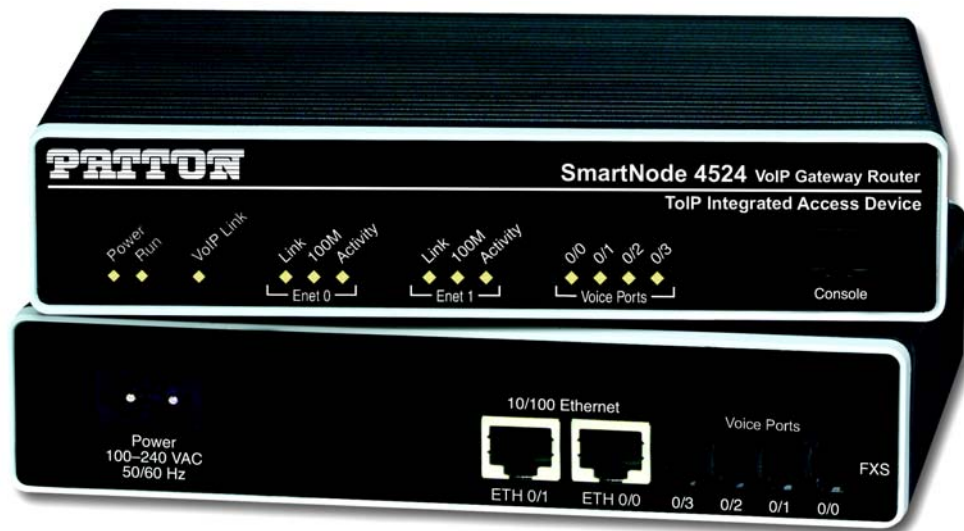

**Important**

This is a Class A device and is intended for use in a light industrial environment. It is not intended nor approved for use in an industrial or residential environment.

Sales Office: +1 (301) 975-1000  
Technical Support: +1 (301) 975-1007  
E-mail: [support@patton.com](mailto:support@patton.com)  
WWW: [www.patton.com](http://www.patton.com)

Part Number: **07MD4524-GS, Rev. 1**  
Revised: **June 21, 2012**

**Patton Electronics Company, Inc.**

7622 Rickenbacker Drive  
Gaithersburg, MD 20879 USA  
tel: +1 (301) 975-1000  
fax: +1 (301) 869-9293  
support: +1 (301) 975-1007  
web: [www.patton.com](http://www.patton.com)  
e-mail: [support@patton.com](mailto:support@patton.com)

**Trademark Statement**

The terms *SmartWare* and *SmartView* are trademarks of Patton Electronics Company. All other trademarks presented in this document are the property of their respective owners.

**Copyright © 2012, Patton Electronics Company. All rights reserved.**

The information in this document is subject to change without notice. Patton Electronics assumes no liability for errors that may appear in this document.

**Warranty Information**

The software described in this document is furnished under a license and may be used or copied only in accordance with the terms of such license.

**Patton Electronics** warrants all SmartNode router components to be free from defects, and will—at our option—repair or replace the product should it fail within one year from the first date of the shipment.

This warranty is limited to defects in workmanship or materials, and does not cover customer damage, abuse or unauthorized modification. If the product fails to perform as warranted, your sole recourse shall be repair or replacement as described above. Under no condition shall **Patton Electronics** be liable for any damages incurred by the use of this product. These damages include, but are not limited to, the following: lost profits, lost savings and incidental or consequential damages arising from the use of or inability to use this product. **Patton Electronics** specifically disclaims all other warranties, expressed or implied, and the installation or use of this product shall be deemed an acceptance of these terms by the user.

# Table of Contents

<b>Table of Contents</b> .....	<b>3</b>
<b>About this guide</b> .....	<b>6</b>
Audience.....	6
Structure.....	6
Precautions .....	7
Safety when working with electricity .....	7
Preventing electrostatic discharge damage .....	8
General observations .....	9
Typographical conventions used in this document.....	9
General conventions .....	9
<b>1 General information</b> .....	<b>10</b>
SmartNode Series VoIP routers overview.....	11
SmartNode 4520 Series router .....	12
Ports descriptions .....	14
Reset button behavior .....	14
SmartNode 4110 Series router .....	16
Ports descriptions .....	18
Reset button behavior .....	18
<b>2 Applications overview</b> .....	<b>20</b>
Introduction.....	21
Applications for SmartNode 4110 Series .....	21
SIP and H.323 terminal and PSTN gateways .....	21
Application—Analog line extension over IP .....	22
Application—ITSP dial-in access .....	22
Application—Private line automatic ringdown (PLAR) .....	23
Application—Enterprise campus BRI to FXS telephony extension .....	23
Application—PBX toll bypass gateway .....	24
Applications for SmartNode 4520 Series .....	24
Application—SOHO off-premise extension .....	25
Application—Single-phone PSTN and VoIP access .....	26
<b>3 Hardware installation</b> .....	<b>27</b>
Planning the installation .....	28
Installation checklist .....	29
Site log .....	30
Network information .....	30
Network Diagram .....	30
IP related information .....	30
Software tools .....	30
Power source .....	30

Location and mounting requirements .....	31
Installing the gateway router.....	31
Mounting the gateway router .....	31
Connecting cables .....	31
Installing an interface cable on the router's FXS and FXO interface ports .....	32
Installing the Ethernet cable .....	34
Connecting to external power source .....	36
<b>4 Getting started with the SmartNode.....</b>	<b>38</b>
Introduction.....	39
1. Configure IP address .....	40
Power connection and default configuration .....	40
Connect with the serial interface .....	40
Login .....	41
Changing the IP address .....	41
2. Connect the SmartNode to the network.....	42
3. Load configuration .....	42
Bootloader.....	43
Start Bootloader .....	43
Start-up with factory configuration .....	44
Load a new application image (SmartWare) via TFTP .....	44
Load a new application image (SmartWare) via the serial link .....	46
Additional information.....	46
<b>5 LEDs status and monitoring .....</b>	<b>47</b>
Status LEDs.....	48
<b>6 Contacting Patton for assistance .....</b>	<b>51</b>
Introduction.....	52
Contact information.....	52
Warranty Service and Returned Merchandise Authorizations (RMAs).....	52
Warranty coverage .....	52
Out-of-warranty service .....	52
Returns for credit .....	52
Return for credit policy .....	53
RMA numbers .....	53
Shipping instructions .....	53
<b>A Compliance .....</b>	<b>54</b>
Compliance.....	55
EMC Compliance: .....	55
Safety Compliance: .....	55
PSTN Regulatory Compliance: .....	55
CE Declaration of Conformity.....	55
Authorized European Representative.....	55
Radio and TV Interference (FCC Part 15) .....	56

FCC Part 68 (ACTA) Statement (FXO Ports) .....	56
Industry Canada Notice (FXO Ports) .....	56
<b>B Specifications .....</b>	<b>58</b>
DSP .....	59
Voice connectivity .....	59
Connectivity .....	59
Voice processing (signalling dependent) .....	59
Fax and modem support .....	59
Voice signalling .....	60
Voice routing—session router .....	60
IP services .....	60
Management .....	61
Operating environment .....	61
Operating temperature .....	61
Operating humidity .....	61
System .....	61
Dimensions .....	61
Weight and power dissipation .....	61
Power supply .....	62
AC version .....	62
DC version .....	62
Identification of the SmartNode devices via SNMP .....	62
<b>C Cabling .....</b>	<b>64</b>
Introduction .....	65
Serial console .....	65
Ethernet 10Base-T and 100Base-T .....	66
Analog FXS .....	68
Analog FXO .....	69
<b>D Port pin-outs .....</b>	<b>70</b>
Introduction .....	71
Console port .....	71
Ethernet 10Base-T and 100Base-T port .....	71
FXS port .....	72
FXO port .....	72
<b>E SmartNode 4110 Series factory configuration .....</b>	<b>73</b>
Introduction .....	74
<b>F SmartNode 4520 Series factory configuration .....</b>	<b>75</b>
Introduction .....	76
<b>G Installation checklist .....</b>	<b>77</b>
Introduction .....	78

# About this guide

---

This guide describes the SmartNode 4110 and 4520 Series hardware, installation and basic configuration. For detailed software configuration information refer to the *SmartWare Software Configuration Guide* and the available Configuration Notes.

## Audience

---

This guide is intended for the following users:

- Operators
- Installers
- Maintenance technicians

## Structure

---

This guide contains the following chapters and appendices:

- [Chapter 1](#) on page 10 provides information about router features and capabilities
- [Chapter 2](#) on page 20 contains an overview describing router operation and applications
- [Chapter 3](#) on page 27 provides quick start hardware installation procedures
- [Chapter 4](#) on page 38 describes getting started with the SmartNode router
- [Chapter 5](#) on page 47 contains definitions for the LED status indicators
- [Chapter 6](#) on page 51 contains information on contacting Patton technical support for assistance
- [Appendix B](#) on page 58 contains specifications for the routers
- [Appendix C](#) on page 64 provides cable recommendations
- [Appendix D](#) on page 70 describes the router's ports and pin-outs
- [Appendix E](#) on page 73 lists the factory configuration settings for SmartNode 4110 Series devices
- [Appendix F](#) on page 75 lists the factory configuration settings for SmartNode 4520 Series devices
- [Appendix G](#) on page 77 lists the tasks for installing a SmartNode 4520 or 4110 Series router

For best results, read the contents of this guide *before* you install the router.

## Precautions

Notes and cautions, which have the following meanings, are used throughout this guide to help you become aware of potential Router problems. *Warnings* relate to personal injury issues, and *Cautions* refer to potential property damage.

**Note** Calls attention to important information.



The shock hazard symbol and **WARNING** heading indicate a potential electric shock hazard. Strictly follow the warning instructions to avoid injury caused by electric shock.



The alert symbol and **WARNING** heading indicate a potential safety hazard. Strictly follow the warning instructions to avoid personal injury.



The shock hazard symbol and **CAUTION** heading indicate a potential electric shock hazard. Strictly follow the instructions to avoid property damage caused by electric shock.



The alert symbol and **CAUTION** heading indicate a potential hazard. Strictly follow the instructions to avoid property damage.

## Safety when working with electricity



The SmartNode contains no user serviceable parts. The equipment shall be returned to Patton Electronics for repairs, or repaired by qualified service personnel.



**Mains Voltage:** Do not open the case when the power cord is connected. For systems without a power switch, line voltages are present within the power supply when the power cord is connected. The mains outlet that is utilized to power the SmartNode router shall be within 10 feet (3 meters) of the device, shall be easily accessible, and protected by a circuit breaker.



For AC powered units, ensure that the power cable used meets all applicable standards for the country in which it is to be installed, and that it is connected to a wall outlet which has earth ground.



**For units with an external power adapter, the adapter shall be a listed Limited Power Source.**



**Hazardous network voltages are present in WAN ports regardless of whether power to the SmartNode is ON or OFF. To avoid electric shock, use caution when near WAN ports. When detaching the cables, detach the end away from the SmartNode first.**



**Before opening the chassis, disconnect the telephone network cables to avoid contact with telephone line voltages. When detaching the cables, detach the end away from the SmartNode first.**



**Do not work on the system or connect or disconnect cables during periods of lightning activity.**



In accordance with the requirements of council directive 2002/96/EC on Waste of Electrical and Electronic Equipment (WEEE), ensure that at end-of-life you separate this product from other waste and scrap and deliver to the WEEE collection system in your country for recycling.

### **Preventing electrostatic discharge damage**

When starting to install interface cards place the interface card on its shielded plastic bag if you lay it on your bench.



Electrostatic Discharge (ESD) can damage equipment and impair electrical circuitry. It occurs when electronic printed circuit cards are improperly handled and can result in complete or intermittent failures. Do the following to prevent ESD:

- Always follow ESD prevention procedures when removing and replacing cards.
- Wear an ESD-preventive wrist strap, ensuring that it makes good skin contact. Connect the clip to an unpainted surface of the chassis frame to safely channel unwanted ESD voltages to ground.
- To properly guard against ESD damage and shocks, the wrist strap and cord must operate effectively. If no wrist strap is available, ground yourself by touching the metal part of the chassis.



### General observations

- Clean the case with a soft slightly moist anti-static cloth
- Place the unit on a flat surface and ensure free air circulation
- Avoid exposing the unit to direct sunlight and other heat sources
- Protect the unit from moisture, vapors, and aggressive liquids

## Typographical conventions used in this document

This section describes the typographical conventions and terms used in this guide.

### General conventions

The procedures described in this manual use the following text conventions:

Table 1. General conventions

Convention	Meaning
Garamond blue type	Indicates a cross-reference hyperlink that points to a figure, graphic, table, or section heading. Clicking on the hyperlink jumps you to the reference. When you have finished reviewing the reference, click on the <b>Go to Previous View</b> button  in the Adobe® Acrobat® Reader toolbar to return to your starting point.
<b>Futura bold type</b>	Commands and keywords are in <b>boldface</b> font.
<b><i>Futura bold-italic type</i></b>	Parts of commands, which are related to elements already named by the user, are in <b>boldface italic</b> font.
<i>Italicized Futura type</i>	Variables for which you supply values are in <i>italic</i> font
Futura type	Indicates the names of fields or windows.
Garamond bold type	Indicates the names of command buttons that execute an action.
< >	Angle brackets indicate function and keyboard keys, such as <SHIFT>, <CTRL>, <C>, and so on.
[ ]	Elements in square brackets are optional.
{ a   b   c }	Alternative but required keywords are grouped in braces ( { } ) and are separated by vertical bars (   )
blue screen	Information you enter is in <b>blue screen</b> font.
screen	Terminal sessions and information the system displays are in <b>screen</b> font.
<b>node</b>	The leading IP address or nodename of a SmartNode is substituted with <b>node</b> in <b>boldface italic</b> font.
<b>SN</b>	The leading <b>SN</b> on a command line represents the nodename of the SmartNode
#	An hash sign at the beginning of a line indicates a comment line.

# Chapter 1 **General information**

## **Chapter contents**

SmartNode Series VoIP routers overview.....	11
SmartNode 4520 Series router .....	12
Ports descriptions .....	14
Reset button behavior .....	14
SmartNode 4110 Series router .....	16
Ports descriptions .....	18
Reset button behavior .....	18

## SmartNode Series VoIP routers overview

The SmartNode 4520 and 4110 Series VoIP Gateway Routers (see [figure 1](#)) combine IP routing, VPN/Security, and Quality of Service for up to 8 transparent voice and FAX calls over any IP or PSTN network. Leverage low-cost IP services with packet-voice for complete branch office voice and data connectivity.

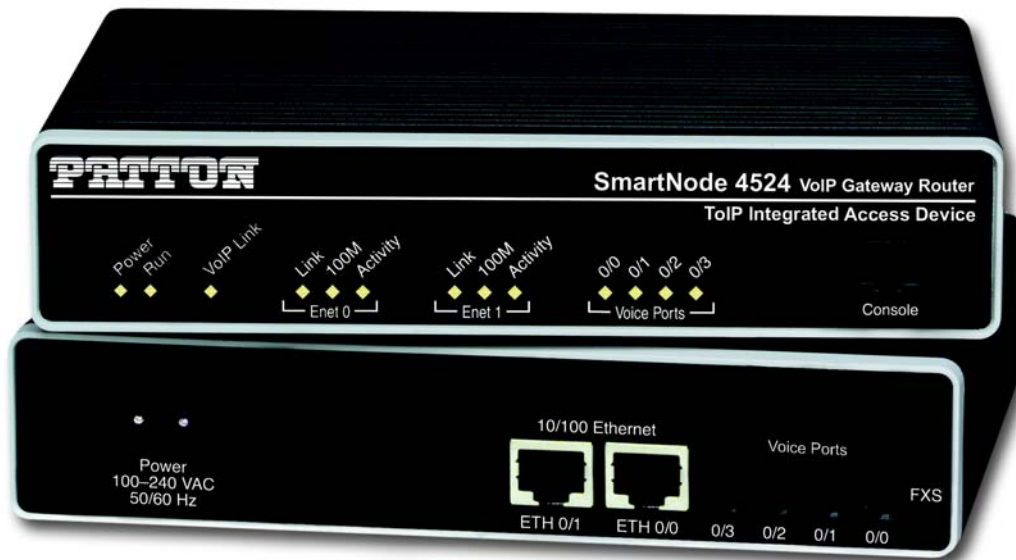

Figure 1. SmartNode Router (SmartNode 4524 shown)

The SmartNode 4520 Series Gateway Routers, equipped with two 10/100Base-T Ethernet ports provide; voice over IP (VoIP) and Internet telephony plus Internet access routing, VPN and firewall functions, and extensive Quality of Service (QoS) functions.

The SmartNode 4110 Series Media Gateways, equipped with a single 10/100Base-T Ethernet port that provide VoIP and Internet telephony.

The SmartNode VoIP Gateways and Gateway-Routers perform the following major functions:

- Voice over IP and local switching via a combination of 2 to 8 analog phone ports (FXS) and 2 to 4 analog line ports (FXO).
- Standard compliant VoIP conversion in accordance with SIP and H.323 protocols.
- Internet access and IP Routing (4520 Series only) with IP Quality of Service (QoS) support for mixed voice and data traffic.

Section “[SmartNode 4520 Series router](#)” on page 12 provides more information on the SmartNode 4520 Series. Section “[SmartNode 4110 Series router](#)” on page 16 describes the SmartNode 4110 Series.

### SmartNode 4520 Series router

The SmartNode 4520 Series are compact VoIP Gateway Routers that support two to eight VoIP calls and various combinations of FXS and FXO ports (see [figure 2](#)).

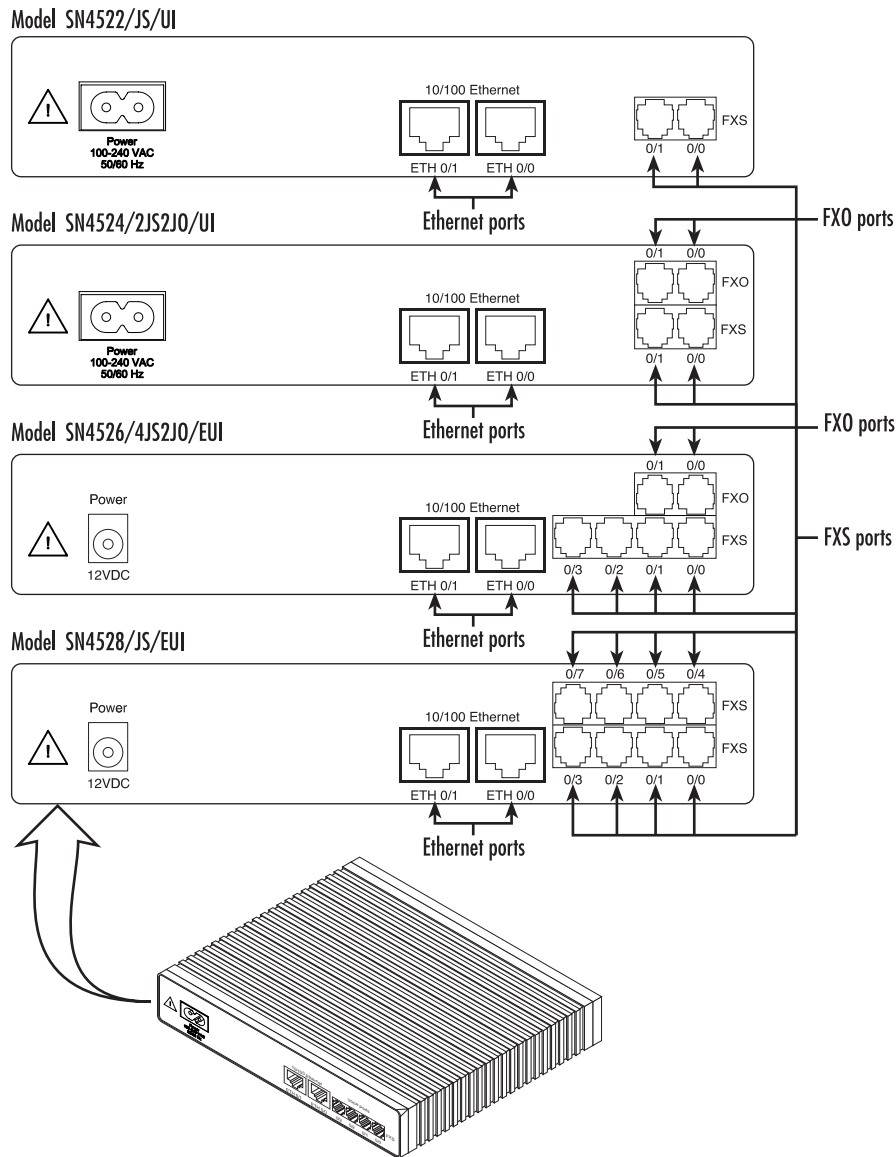

Figure 2. Examples of SN4520 Series rear panels

The following base models (each equipped with two 10/100Base-T Ethernet ports) are available:

- SmartNode 4522 (2 VoIP calls)
- SmartNode 4524 (4 VoIP calls)
- SmartNode 4526 (6 VoIP calls)
- SmartNode 4528 (8 VoIP calls)

The port combinations are indicated in the extension of the model code. The products the following model code conventions apply:

- *JS* stands for FXS ports
- *JO* stands for FXO ports
- *UI* stands for integrated universal input power supply (see figure 3)
- *EUI* stands for external universal input power supply (see figure 3)

For example, the model code *SN4526/4JS2JO/EUI* describes a SmartNode configured as follows:

- 4 FXS ports
- 2 FXO ports
- External power supply

**Note** For a complete listing of available models, refer to the SmartNode VoIP page at <http://www.patton.com/voip/>.

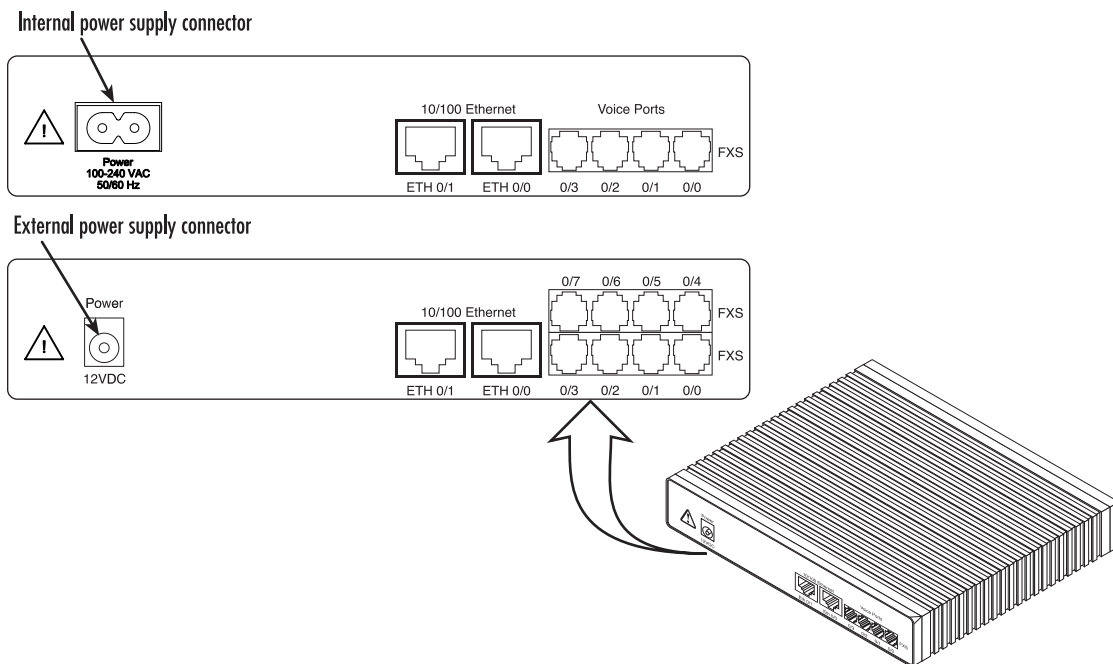

Figure 3. SmartNode 4520 Series power input connectors

### Ports descriptions

The SmartNode 4520 Series rear panel ports are described in [table 2](#).

Table 2. Rear panel ports

Port	Location	Description
10/100 Ethernet ETH 0/0 & ETH 0/1	Rear panel	RJ-45 connectors (see <a href="#">figure 16</a> on page 32) that connect the router to an Ethernet device (e.g., a cable or DSL modem, LAN hub or switch).
Analog voice port, FXS	Rear panel	FXS RJ-11 (6 position, 4 wire) connectors (see <a href="#">figure 16</a> on page 32) that connect the router with an analog terminal (a telephone, for example) FXO port. EuroPOTS support (ETSI EG201 188). FXS on-hook voltage is 48V for each FXS port.
Analog voice port, FXO	Rear panel	FXO RJ-11 (6 position, 4 wire) connectors (see <a href="#">figure 16</a> on page 32) that connect the router with an analog line (FXS port). EuroPOTS support (ETSI EG201 188).
Power	Rear panel	The gateway is available in a DC or AC power input version (see <a href="#">figure 3</a> ), labeled as follows: <ul style="list-style-type: none"> <li>• AC version (Internal power supply): 100–240 VAC, 50/60 Hz, 200 mA</li> <li>• DC version: 12 VDC, 1.25 A</li> </ul>
Console	Front panel	Used for service and maintenance, the Console port (see <a href="#">figure 4</a> on page 15), an RS-232 RJ-45 connector, connects the router to a serial terminal such as a PC or ASCII terminal (also called a dumb terminal).

### Reset button behavior

For those SmartNode devices that have a *Reset* button on the rear panel, its behavior is as follows:

- To restart the unit with the current startup configuration—Press for less than 1 second and release the *Reset* button. The SmartNode will restart with the current startup configuration.
- To restart the unit with factory default configuration—Press the *Reset* button for 5 seconds until the Power LED starts blinking. The unit will restart with factory default configuration.
- To restart the unit in bootloader mode (to be used only by trained SmartNode technicians)—Start with the unit powered off. Press and hold the *Reset* button while applying power to the unit. Release the *Reset* button when the *Power* LED starts blinking so the unit will enter bootloader mode.

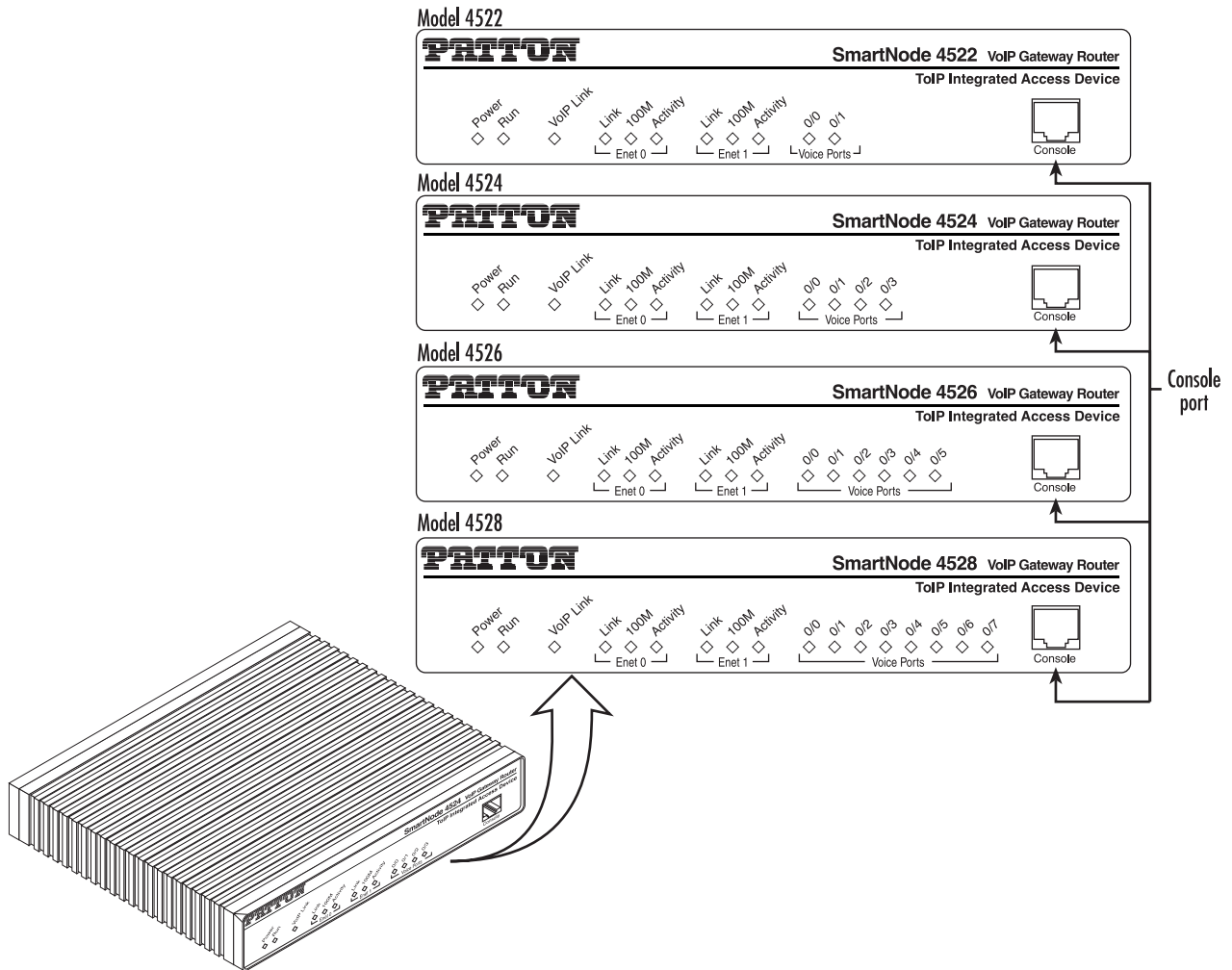

Figure 4. SmartNode 4520 Series front panels

**Note** For LED descriptions, refer to chapter 5, “LEDs status and monitoring” on page 47.

### SmartNode 4110 Series router

The SmartNode 4110 Series are compact VoIP Gateways that support two to eight VoIP calls and various combinations of FXS and FXO ports (see figure 5).

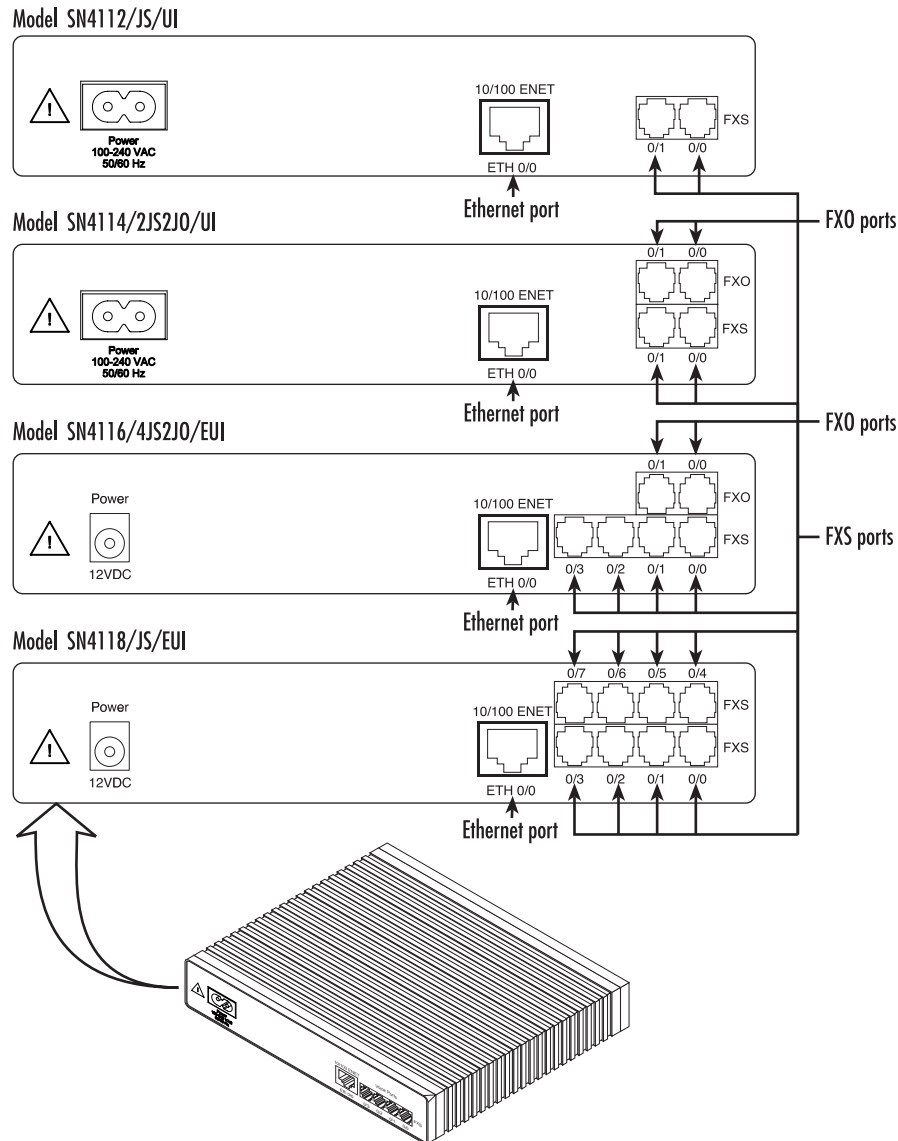

Figure 5. Examples of SN4110 Series rear panels

The following base models (each equipped with one 10/100Base-T Ethernet port) are available:

- SmartNode 4112 (2 VoIP calls)
- SmartNode 4114 (4 VoIP calls)
- SmartNode 4116 (6 VoIP calls)
- SmartNode 4118 (8 VoIP calls)



The port combinations are indicated in the extension of the model code. The products the following model code conventions apply:

- *JS* stands for FXS ports
- *JO* stands for FXO ports
- *UI* stands for integrated universal input power supply (see figure 6)
- *EUI* stands for external universal input power supply (see figure 6)

For example, the model code *SN4116/4JS2JO/EUI* describes a SmartNode configured as follows:

- 4 FXS ports
- 2 FXO ports
- External power supply

**Note** For a complete listing of available models, refer to the SmartNode VoIP page at <http://www.patton.com/voip/>.

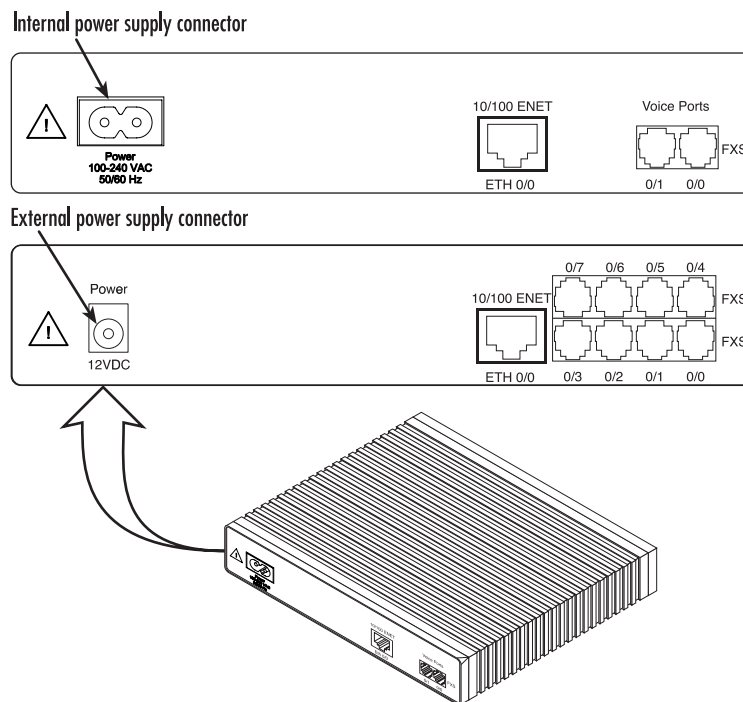

Figure 6. SmartNode 4110 Series power input connectors

### Ports descriptions

The SmartNode 4110 Series rear panel ports are described in [table 3](#).

Table 3. Rear panel ports

Port	Location	Description
10/100 Ethernet ETH 0/0	Rear panel	RJ-45 connector (see <a href="#">figure 5</a> on page 16) that connects the router to an Ethernet device (a cable or DSL modem, LAN hub or switch, for example).
Analog voice port, FXS	Rear panel	FXS RJ-11 (6 position, 4 wire) connectors (see <a href="#">figure 16</a> on page 32) that connect the router with an analog terminal (a telephone, for example) FXO port. EuroPOTS support (ETSI EG201 188).
Analog voice port, FXO	Rear panel	FXO RJ-11 (6 position, 4 wire) connectors (see <a href="#">figure 16</a> on page 32) that connect the router with an analog line (FXS port). EuroPOTS support (ETSI EG201 188).
Power	Rear panel	The gateway is available in a DC or AC power input version (see <a href="#">figure 6</a> ), labeled as follows: <ul style="list-style-type: none"> <li>• AC version (Internal power supply): 100–240 VAC, 50/60 Hz, 200 mA</li> <li>• DC version: 12 VDC, 1.25 A</li> </ul>
Console	Front panel	Used for service and maintenance, the Console port (see <a href="#">figure 7</a> on page 19), an RS-232 RJ-45 connector, connects the router to a serial terminal such as a PC or ASCII terminal (also called a dumb terminal).

### Reset button behavior

For those SmartNode devices that have a *Reset* button on the rear panel, its behavior is as follows:

- To restart the unit with the current startup configuration—Press for less than 1 second and release the *Reset* button. The SmartNode will restart with the current startup configuration.
- To restart the unit with factory default configuration—Press the *Reset* button for 5 seconds until the Power LED starts blinking. The unit will restart with factory default configuration.
- To restart the unit in bootloader mode (to be used only by trained SmartNode technicians)—Start with the unit powered off. Press and hold the *Reset* button while applying power to the unit. Release the *Reset* button when the *Power* LED starts blinking so the unit will enter bootloader mode.

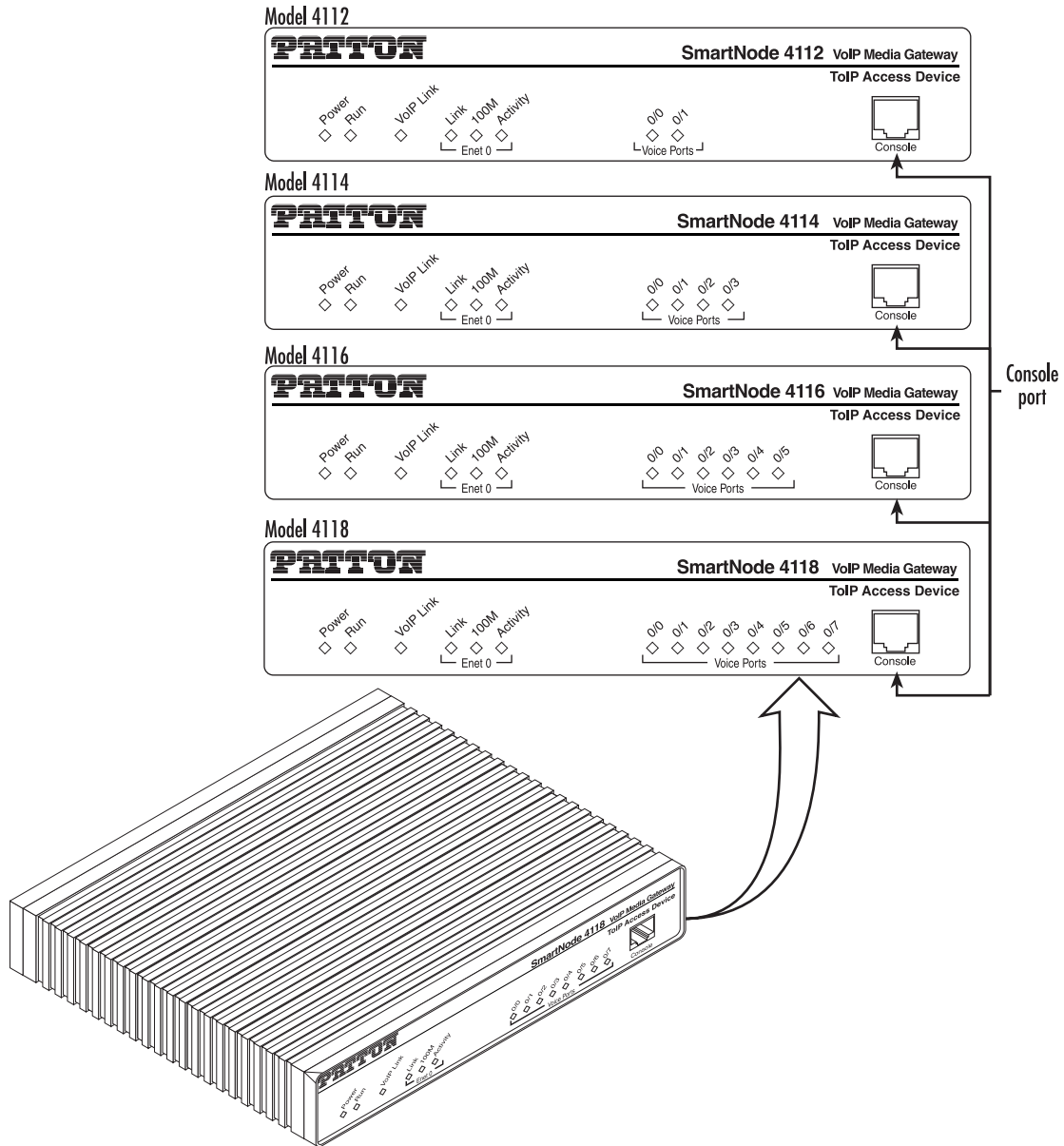

Figure 7. SmartNode 4110 Series front panels

**Note** For LED descriptions, refer to chapter 5, “LEDs status and monitoring” on page 47.

## Chapter 2 **Applications overview**

### **Chapter contents**

Introduction .....	21
Applications for SmartNode 4110 Series .....	21
SIP and H.323 terminal and PSTN gateways .....	21
Application—Analog line extension over IP .....	22
Application—ITSP dial-in access .....	22
Application—Private line automatic ringdown (PLAR) .....	23
Application—Enterprise campus BRI to FXS telephony extension .....	23
Application—PBX toll bypass gateway .....	24
Applications for SmartNode 4520 Series .....	24
Application—SOHO off-premise extension .....	25
Application—Single-phone PSTN and VoIP access .....	26

## Introduction

Patton's SmartNode Media Gateway Routers deliver the features you need for advanced multiservice voice and data network applications. They combine high quality voice-over-IP with powerful *quality of service* routing functions to build professional and reliable VoIP networks. This chapter describes typical applications for which the SmartNodes are uniquely suited.

**Note** Detailed configuration information for SmartNode applications can be found online at [www.patton.com/smartnode](http://www.patton.com/smartnode).

## Applications for SmartNode 4110 Series

The SmartNode 4110 Series device, equipped with a single Ethernet port, provides gateway and over-IP line extension services.

### SIP and H.323 terminal and PSTN gateways

All models provide *voice-over-IP* and *FAX-over-IP* services for integration into a VoIP network running the SIP or H.323 protocol (see [figure 8](#)). The SmartNode 4110 Series supports automatic registration to a Gatekeeper or SIP server to provide analog extension services or PSTN breakout connectivity.

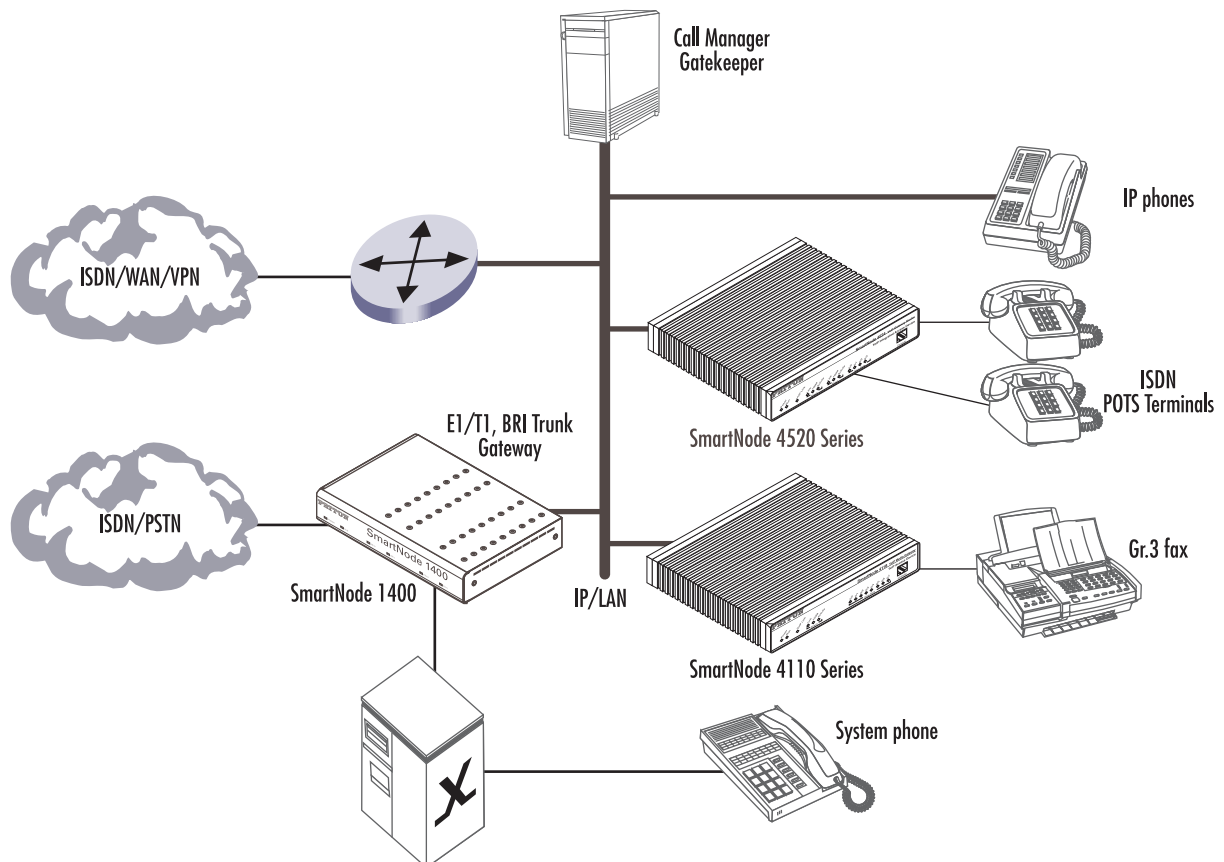

Figure 8. PSTN and Terminal gateways

### Application—Analog line extension over IP

A virtual analog line can be created using an FXO and FXS model (see figure 9). The complete signaling and media (voice, fax, or modem) of the analog phone line is extended over IP. This enables a PBX analog extension line to be extended to a home office or satellite office. The analog line extension relays DTMF, hook-flash and CLI to provide full PBX feature access over the IP network (checking voice mail or joining a calling group, for example).

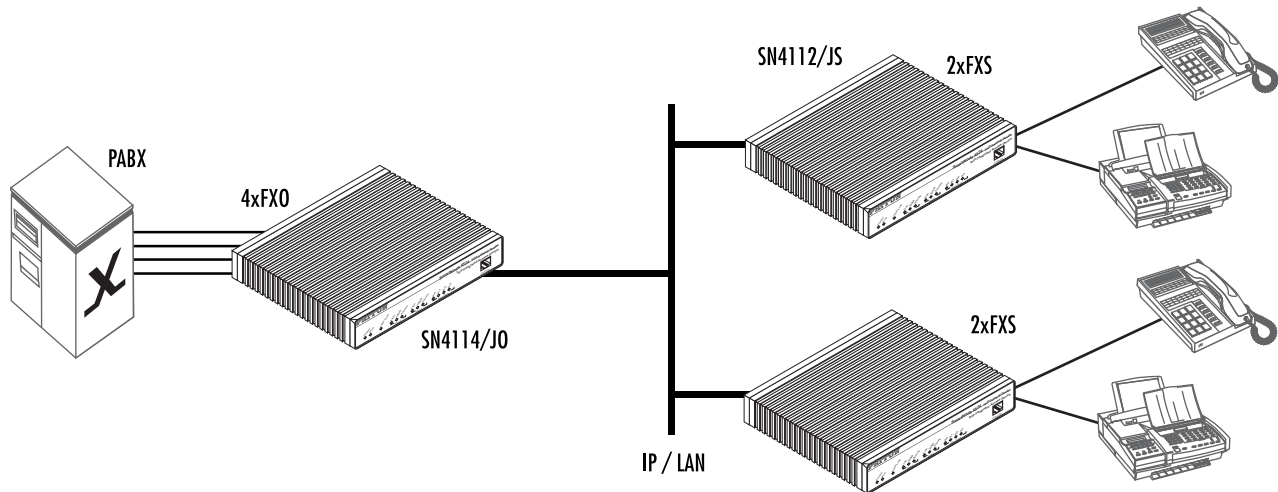

Figure 9. Analog line extension

### Application—ITSP dial-in access

An ITSP can use the SmartNode FXO gateways as dial-in access points to his Internet telephony services (see figure 10). A user calls a local number, the FXO SmartNode picks up the call and uses a second dial-tone to dial the remote number. The system can be enhanced with a central call control server providing IVR announcements, PIN checking, and accounting for the calls.

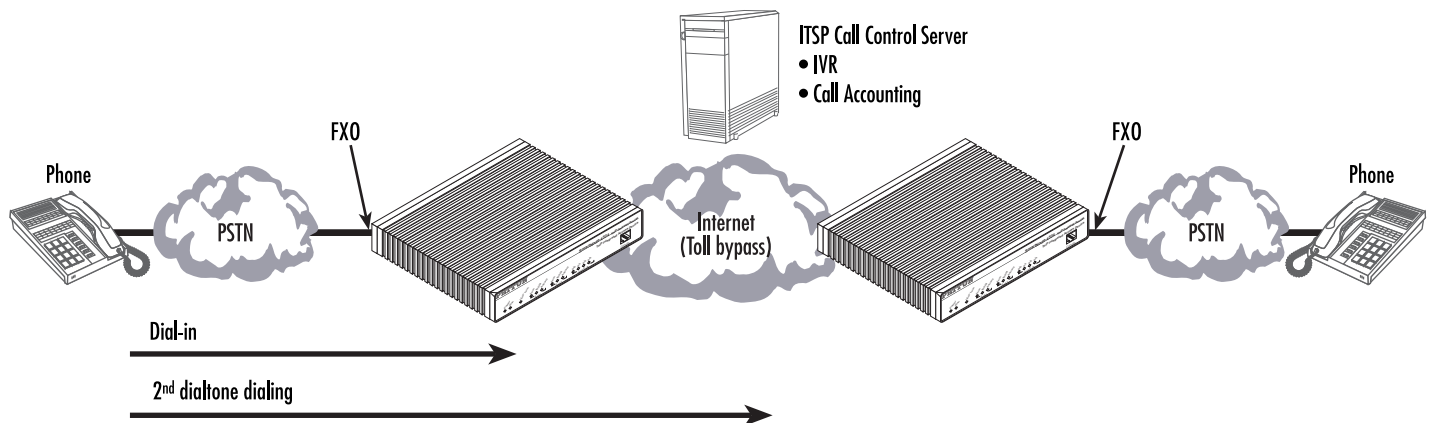

Figure 10. ITSP dial-in access

### Application—Private line automatic ringdown (PLAR)

A private hot-line can be created by using two FXS models back-to-back (see figure 11). These can be found in use as courtesy phones at ATM's, information kiosks, and emergency assistance pedestals. In this application, when one handset is picked-up, the remote handset immediately begins ringing. When the remote handset is picked-up, the speech path is completed. The end-to-end link supports voice, fax Gr.3 (2.4–14.4 kbps) with T.38 or fax- and modem bypass using a G.711 codec.

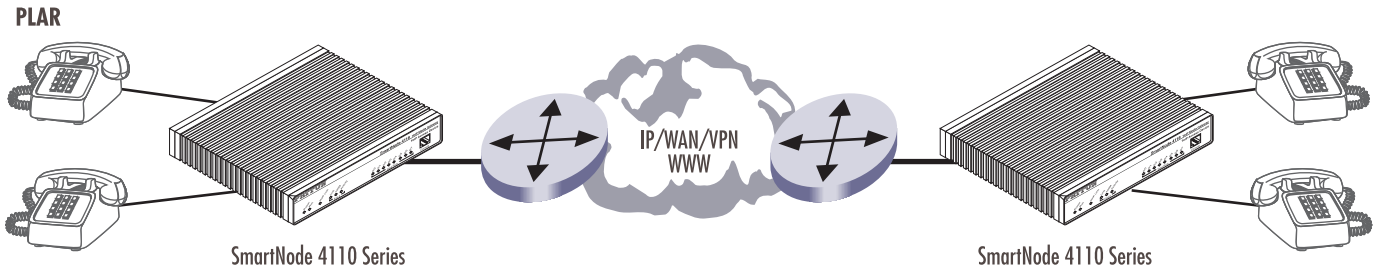

Figure 11. FXS to FXS Hotline

### Application—Enterprise campus BRI to FXS telephony extension

In combination with the Patton SmartNode 1000 and 2000 Series models the FXS gateways provide ISDN BRI to FXS extensions over IP (see figure 12).

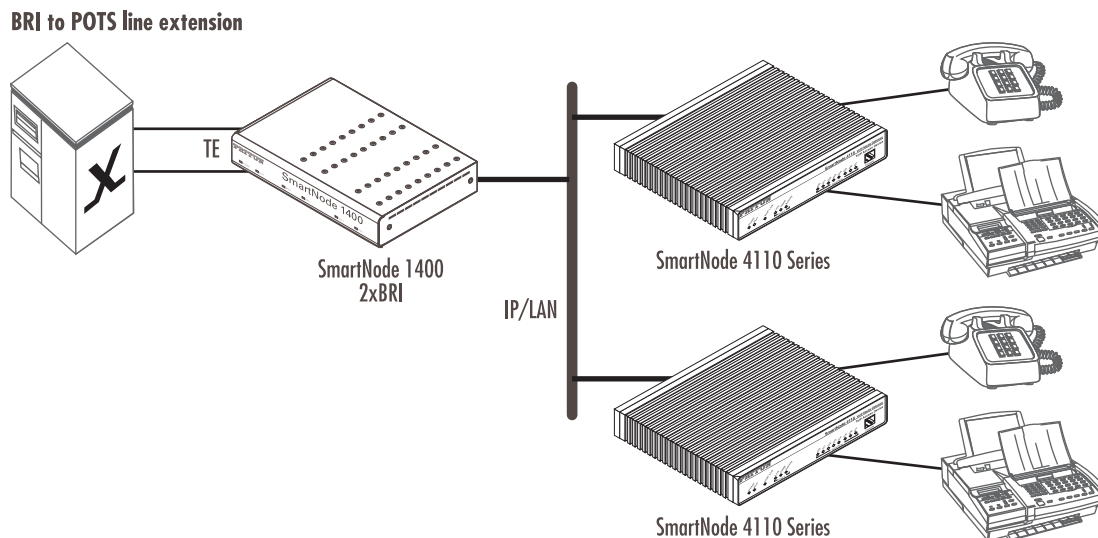

Figure 12. BRI to FXS extension

### Application—PBX toll bypass gateway

The gateways can be used to provide toll bypass over an IP WAN (see figure 13). The call routing in this case is provided by the PBX systems. A call routed to the FXS gateway can be relayed on a port-to-port basis or depending on the dialed-number to the remote gateway.

**Note** With the use of FXS ports, extension dialing on the secondary side must be done by using two-stage dialing (DTMF relay) or a call attendant. DID is not available when using a SmartNode FXS port connected to a PBX FXO port.

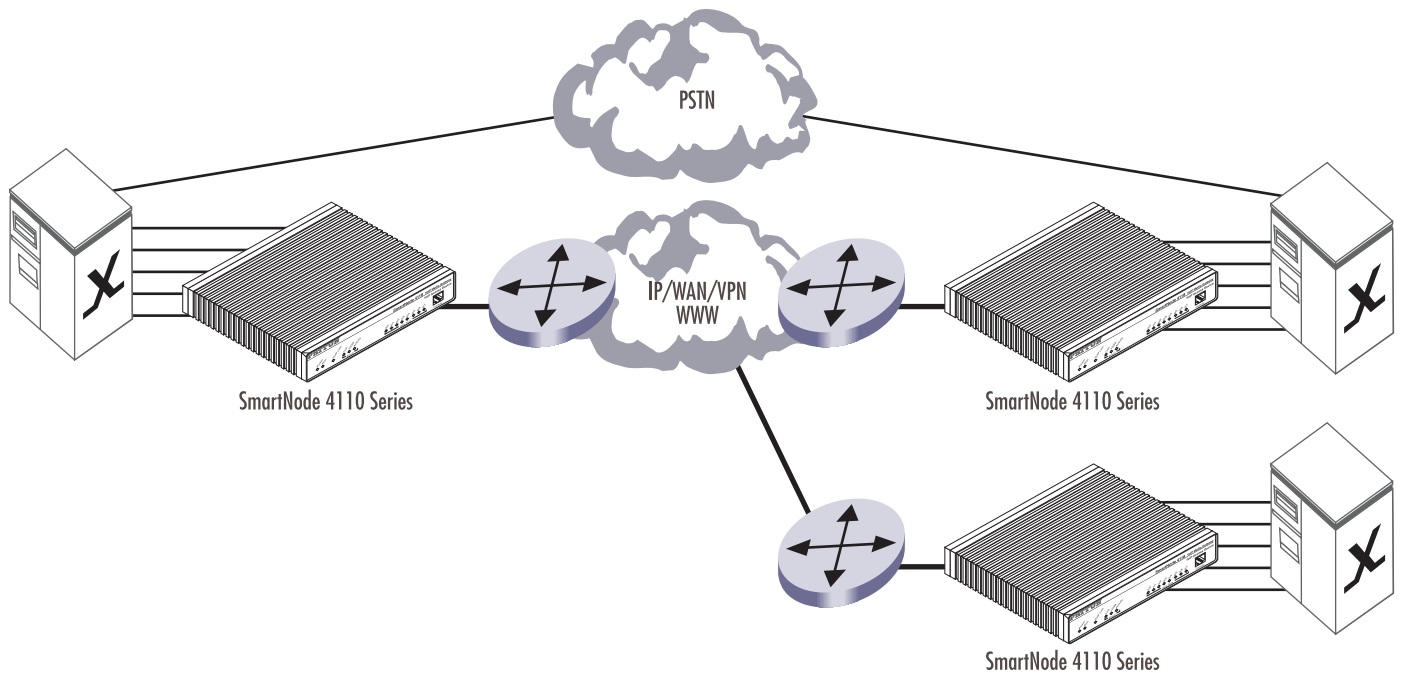

Figure 13. Toll bypass

### Applications for SmartNode 4520 Series

SmartNode 4520 Series devices have dual 10/100Base-T Ethernet ports. The two Ethernet ports provide full featured IP routing between LAN and WAN plus Ethernet and IP layer QoS services. Voice prioritization and traffic management avoid network congestion and provide optimal voice quality. With these additional features the SmartNode 4520 series can add Internet access and data networking to any of the SmartNode 4110 Series applications described previously. The following sections show some typical combined voice-data applications.



### Application—SOHO off-premise extension

For a SOHO/telecommuter, the SmartNode 4520 Series router can provide an off-premise extension to the corporate network (see [figure 14](#)). Along with the analog line extension features, the SmartNode provides Internet access and VPN connectivity to the main office. In this configuration, the remote user will appear to be local and can take advantage of services available to local telephony and LAN users (such as file-server access, station-to-station dialing, outside trunk access, and voice mail). Additionally, the home user can take advantage of corporate dialing rates.

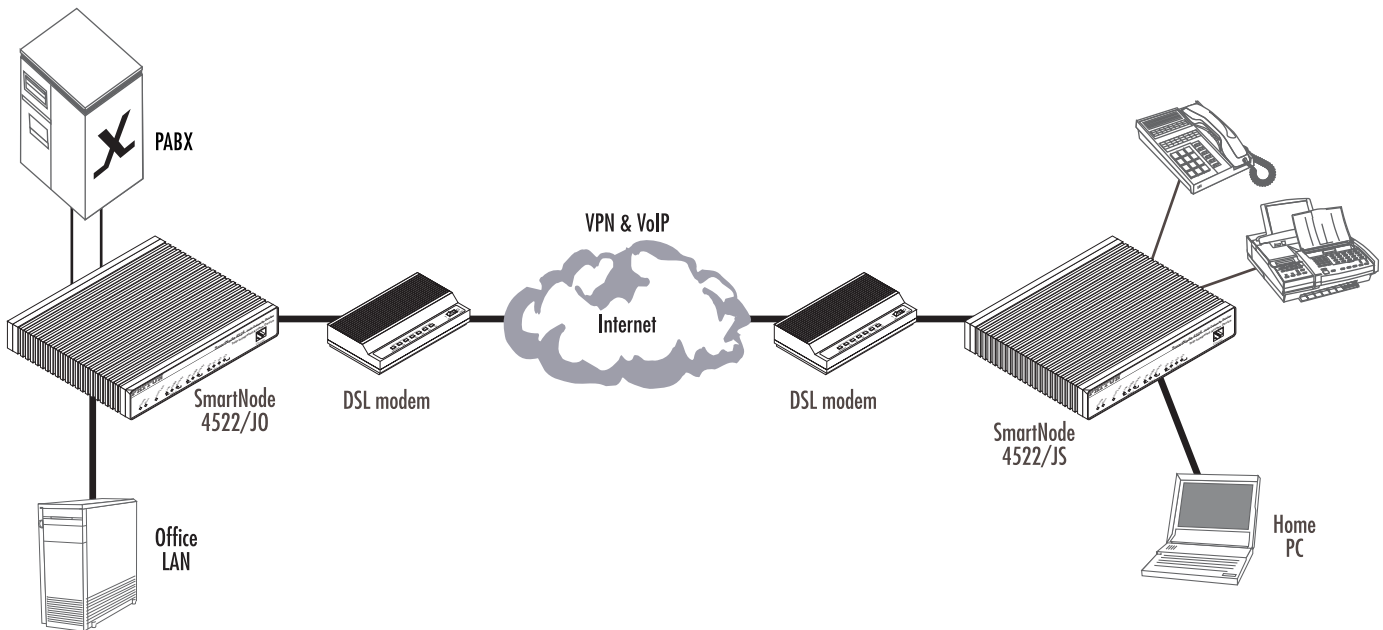

Figure 14. Home office networking

**Application—Single-phone PSTN and VoIP access**

The SmartNode 4520 Series with a combination of FXS and FXO ports can be used to make and receive calls via PSTN and Internet calling services over the same telephone handset (see [figure 15](#)). Using individually configurable routing tables, an outbound call can be directed to the local PSTN connection or to an Internet telephony service provider (ISTP). Inbound calls from the Internet and the PSTN can ring the same phone.

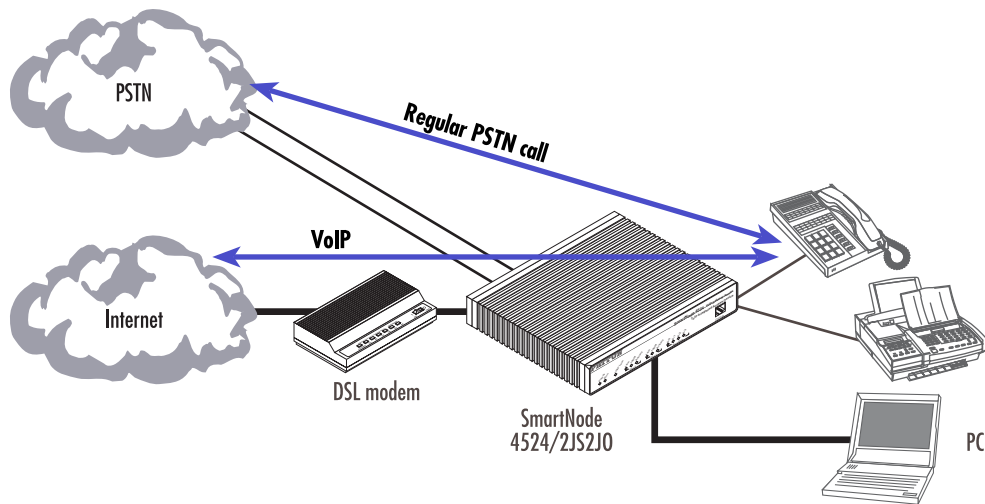

Figure 15. Single-phone access

## Chapter 3 **Hardware installation**

### **Chapter contents**

Planning the installation .....	28
Installation checklist .....	29
Site log .....	30
Network information .....	30
Network Diagram .....	30
IP related information .....	30
Software tools .....	30
Power source .....	30
Location and mounting requirements .....	31
Installing the gateway router.....	31
Mounting the gateway router .....	31
Connecting cables .....	31
Installing an interface cable on the router's FXS and FXO interface ports .....	32
Installing the Ethernet cable .....	34
Connecting to external power source .....	36

## Planning the installation

Before you start the actual installation, it is strongly recommended that you gather all the information needed to install and setup the device. See [table 4](#) for an example of what pre-installment checks you might need to carry out. Having carried out the pre-installation checks enables you to install and set up your gateway router into an existing infrastructure with confidence.



The mains outlet that is utilized to power the equipment must be within 1 foot (3 meters) of the device and shall be easily accessible.

**Note** When setting up your gateway router consider cable length limitations, and potential electromagnetic interference (EMI) as defined by the applicable local and international regulations. Ensure that your site is properly prepared before beginning installation.

Before installing the gateway router device, the following tasks should be completed:

- **Create a network diagram** (see section [“Network information”](#) on page 30)
- **Gather IP related information** (see section [“IP related information”](#) on page 30 for more information)
- **Install the hardware and software needed to configure the SmartNode.** (See section [“Software tools”](#) on page 30)
- **Verify power source reliability** (see section [“Power source”](#) on page 30).

When you finish preparing for gateway router installation, go to section [“Installing the gateway router”](#) on page 31 to install the device.

**Installation checklist**

The installation checklist (see [table 4](#)) lists the tasks for installing a SmartNode 4520 or 4110 Series router. Make a copy of this checklist and mark the entries as you complete each task. For each SmartNode 4520 or 4110 Series router, include a copy of the completed checklist in your site log.

Table 4. Installation checklist

Task	Verified by	Date
Network information available & recorded in site log		
Environmental specifications verified		
Site power voltages verified		
Installation site pre-power check completed		
Required tools available		
Additional equipment available		
All printed documents available		
SmartWare release & build number verified		
Rack, desktop, or wall mounting of chassis completed		
Initial electrical connections established		
ASCII terminal attached to console port		
Cable length limits verified		
Initial configuration performed		
Initial operation verified		

### Site log

Patton recommends that you maintain a site log to record all actions relevant to the system, if you do not already keep such a log. Site log entries should include information such as listed in [table 5](#).

Table 5. Sample site log entries

Entry	Description
Installation	Make a copy of the installation checklist and insert it into the site log
Upgrades and maintenance	Use the site log to record ongoing maintenance and expansion history
Configuration changes	Record all changes and the reasons for them
Maintenance	Schedules, requirements, and procedures performed
Comments	Notes, and problems
Software	Changes and updates to SmartWare software

### Network information

Network connection considerations that you should take into account for planning are provided for several types of network interfaces are described in the following sections.

#### Network Diagram

Draw a network overview diagram that displays all neighboring IP nodes, connected elements and telephony components.

### IP related information

Before you can set up the basic IP connectivity for your SmartNode 4000 series you should have the following information:

- IP addresses used for Ethernet LAN and WAN ports
- Subnet mask used for Ethernet LAN and WAN ports
- IP addresses of central H.323 Gatekeeper (if used)
- IP addresses of central PSTN Gateway for H.323 and/or ISoIP based calls
- IP addresses of central TFTP Server used for configuration upload and download

### Software tools

You will need a PC (or equivalent) with a VT-100 emulation program (e.g. HyperTerminal) to configure the software on your SmartNode router.

### Power source

If you suspect that your AC power is not reliable, for example if room lights flicker often or there is machinery with large motors nearby, have a qualified professional test the power. Install a power conditioner if necessary.

### Location and mounting requirements

The SmartNode router is intended to be placed on a desktop or similar sturdy, flat surface that offers easy access to the cables. Allow sufficient space at the rear of the chassis for cable connections. Additionally, you should consider the need to access the unit for future upgrades and maintenance.

### Installing the gateway router

SmartNode gateway router installation consists of the following:

- Placing the device at the desired installation location (see section “Mounting the gateway router” on page 31)
- Installing the interface and power cables (see section “Connecting cables” on page 31)

When you finish installing the SmartNode, go to chapter 4, “Getting started with the SmartNode” on page 38.

### Mounting the gateway router

Place the router on a desktop or similar sturdy, flat surface that offers easy access to the cables. The router should be installed in a dry environment with sufficient space to allow air circulation for cooling.

**Note** For proper ventilation, leave at least 2 inches (5 cm) to the left, right, front, and rear of the SmartNode gateway router.

### Connecting cables



**Do not work on the system or connect or disconnect cables during periods of lightning activity.**



The Interconnecting cables shall be acceptable for external use and shall be rated for the proper application with respect to voltage, current, anticipated temperature, flammability, and mechanical serviceability.

Installing router cables takes place in the following order:

1. Installing the RJ-11 voice port (FXS) cable or cables (see “Installing an interface cable on the router’s FXS and FXO interface ports”)
2. Installing the 10/100 Ethernet port cable or cables (see “Installing the Ethernet cable” on page 34)
3. Installing the power input (see “Connecting to external power source” on page 36)

*Installing an interface cable on the router's FXS and FXO interface ports*

The gateway comes with at least two FXS or FXO analog ports—or a combination of FXS and FXO ports—(see figure 16) located on the back of the router. The FXS interfaces are connected to analog devices via cables (see figure 17) terminated with RJ-11 connectors (see figure 19 and table 6 on page 33 for pin-out information). The FXO interface connects the router with analog lines via cables (see figure 18 on page 33) terminated with RJ-11 connectors (see figure 19 and table 6 on page 33 for pin-out information).

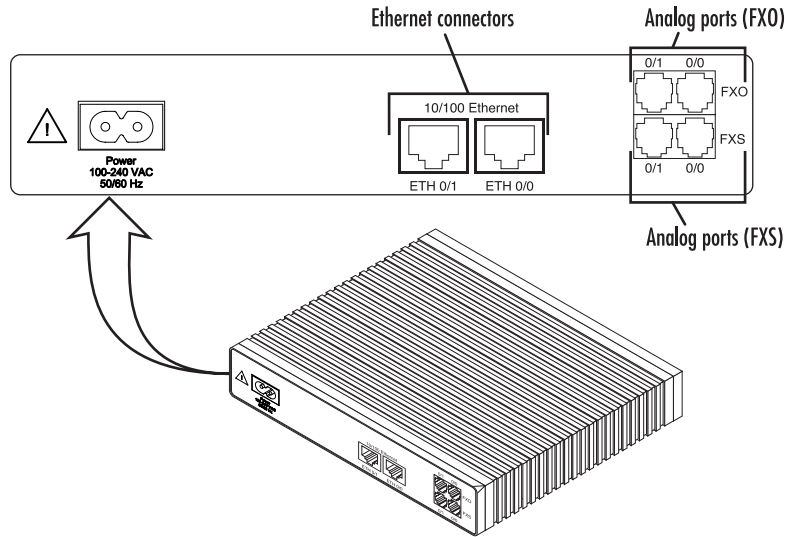

Figure 16. Rear view showing location of Ethernet and FXS connectors (SmartNode 4520 shown)

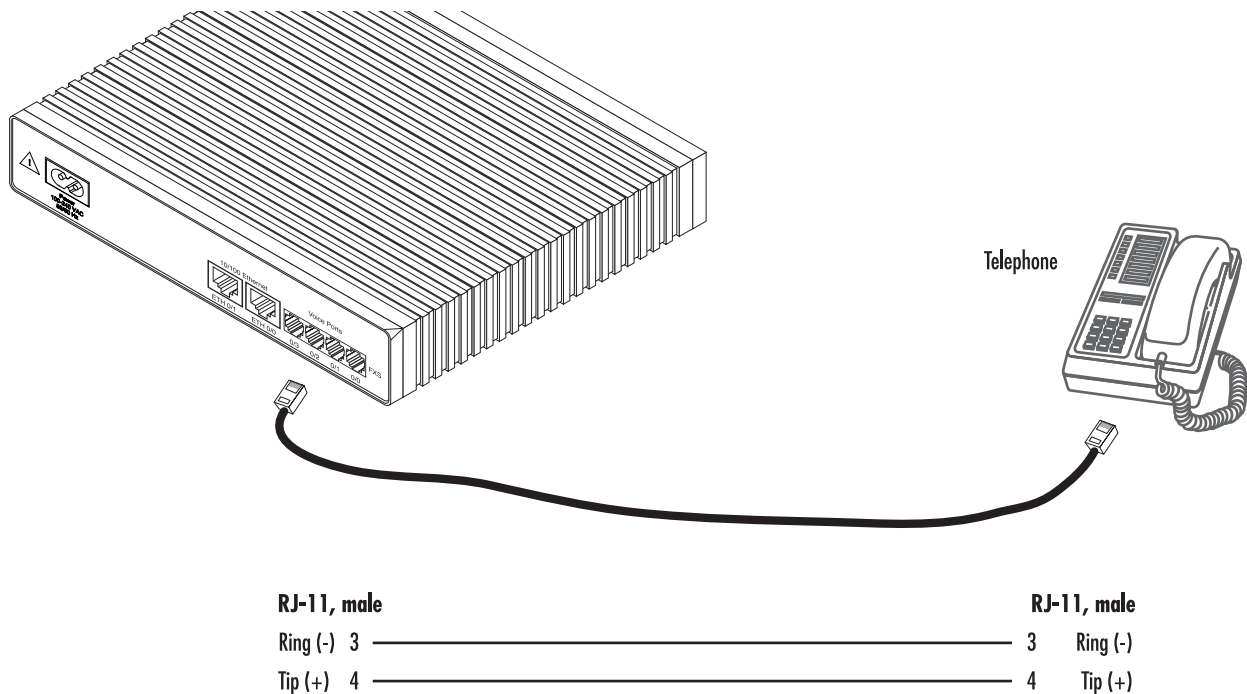

Figure 17. Analog FXS connection



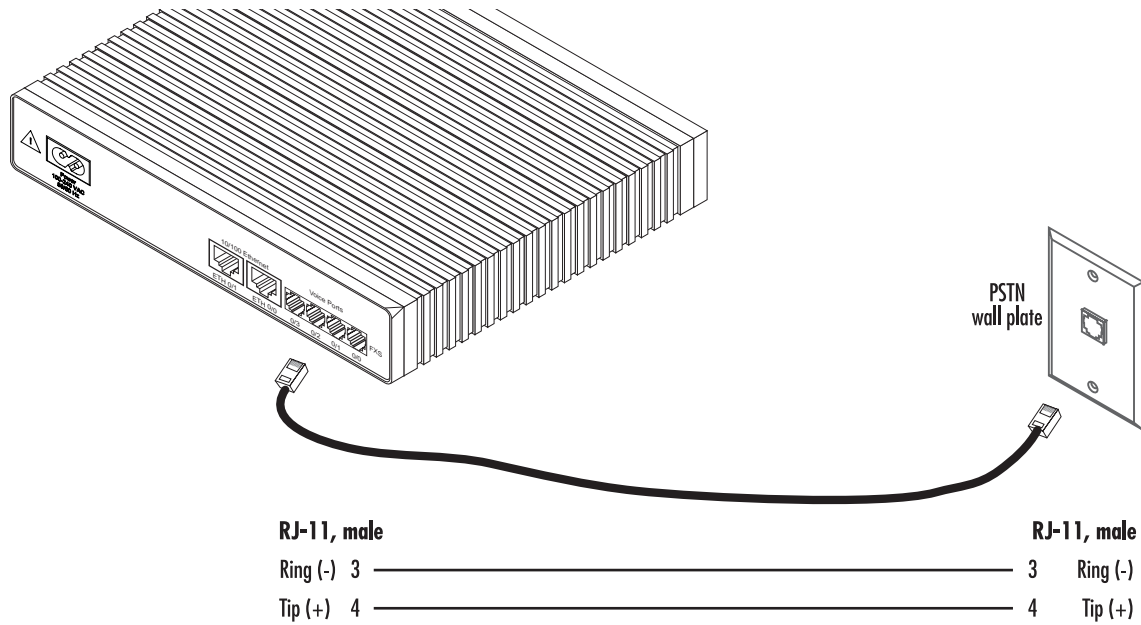

Figure 18. Analog FXO connection

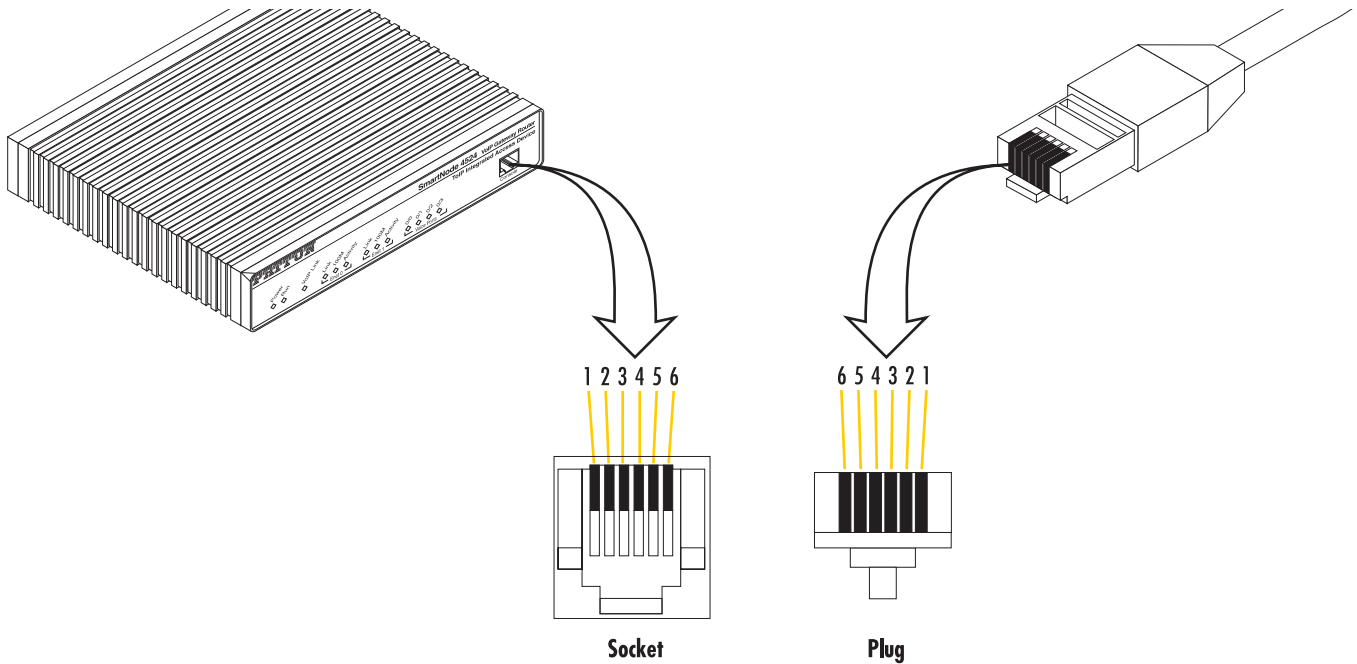

Figure 19. RJ-11 pinout diagram

Table 6. RJ-11 socket

Pin	Signal
3	Ring (-)
4	Tip (+)

**Note** Unit must not connect directly to telecom network voltage (TNV).

### Installing the Ethernet cable

The SmartNode 4520 Series has automatic MDX (auto-cross-over) detection and configuration on the Ethernet ports. Any of the two ports can be connected to a host or hub/switch with a straight-through wired cable (see [figure 20](#) on page 34). Ethernet devices (10Base-T or 100Base-T) are connected to the SmartNode's Ethernet ports (see [table 7](#) for port pin-out listing) via a cable terminated with RJ-45 plugs. Because the SmartNode 4110 Series does not have the MDX feature, a cross-over cable is required when connecting SmartNode 4110 Series devices to a host (see [figure 21](#) on page 35).

Table 7. Ethernet 10/100Base-T (RJ-45) port pin-outs (SmartNode 4110 Series)

Pin	Signal
1	TX+
2	TX-
3	RX+
6	RX-

**Note** Pins not listed are not used.

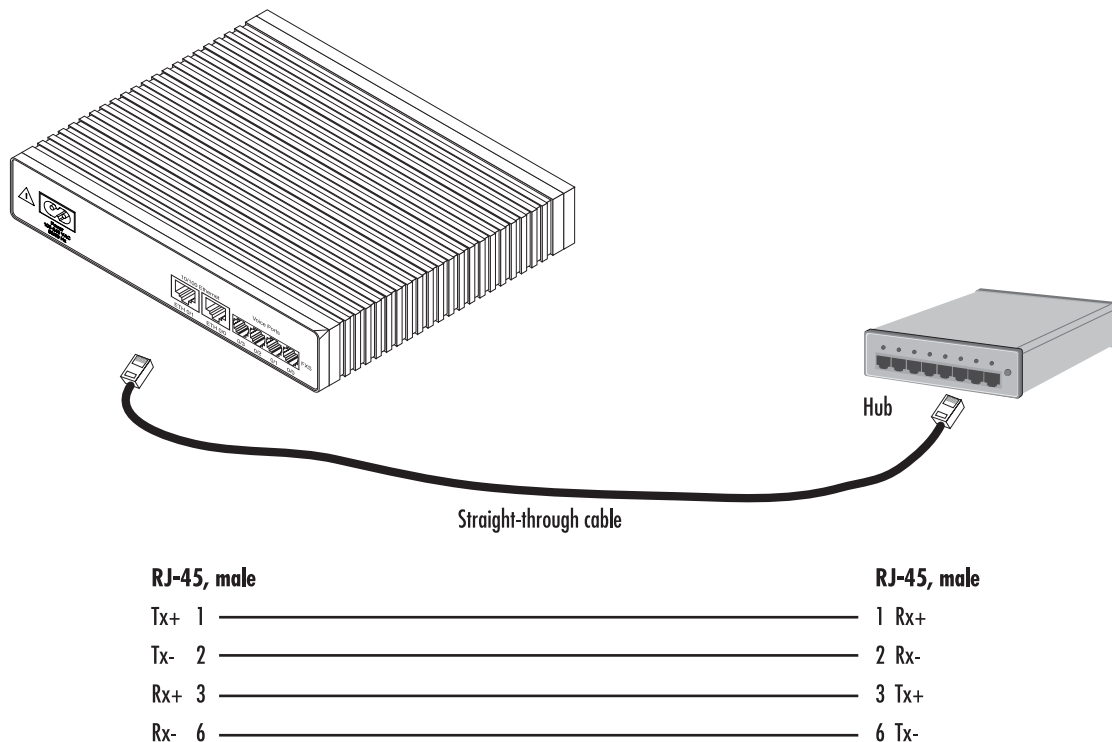

Figure 20. Connecting a SmartNode 4110 Series device to a hub

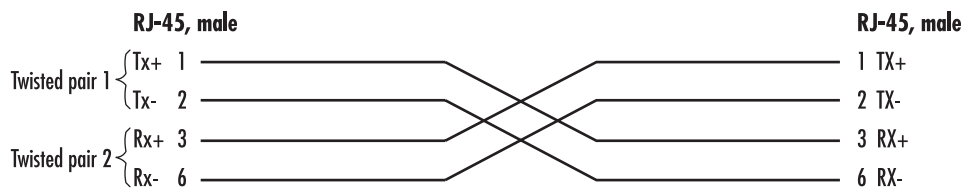
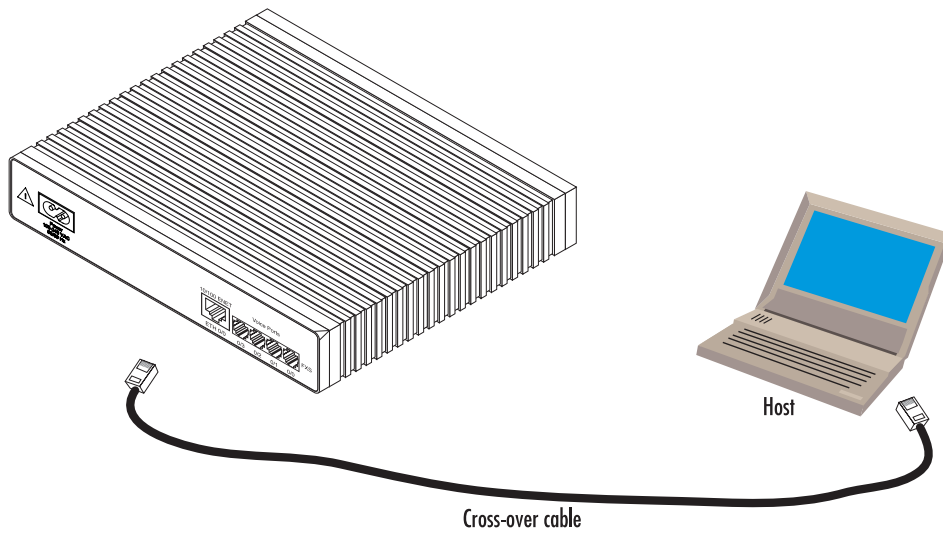

Figure 21. Connecting to a host (cross-over cable required for SmartNode 4110 Series only)

### Connecting to external power source



The terminal block header to which the wires are secured provides the disconnect for the SmartNode. Take proper measures to ensure that it is not permanently fastened to the receptacle mounted on the chassis.

The router comes with an internal or external power supply. This section describes installing the power cord into the router. Do the following:

**Note** *Do not connect the power cord to the power outlet at this time.*

1. If your unit is equipped with an internal power supply, go to step 2. Otherwise, insert the barrel type connector end of the AC power cord into the external power supply connector (see [figure 22](#)).
2. Insert the female end of the power cord into the internal power supply connector (see [figure 22](#)).

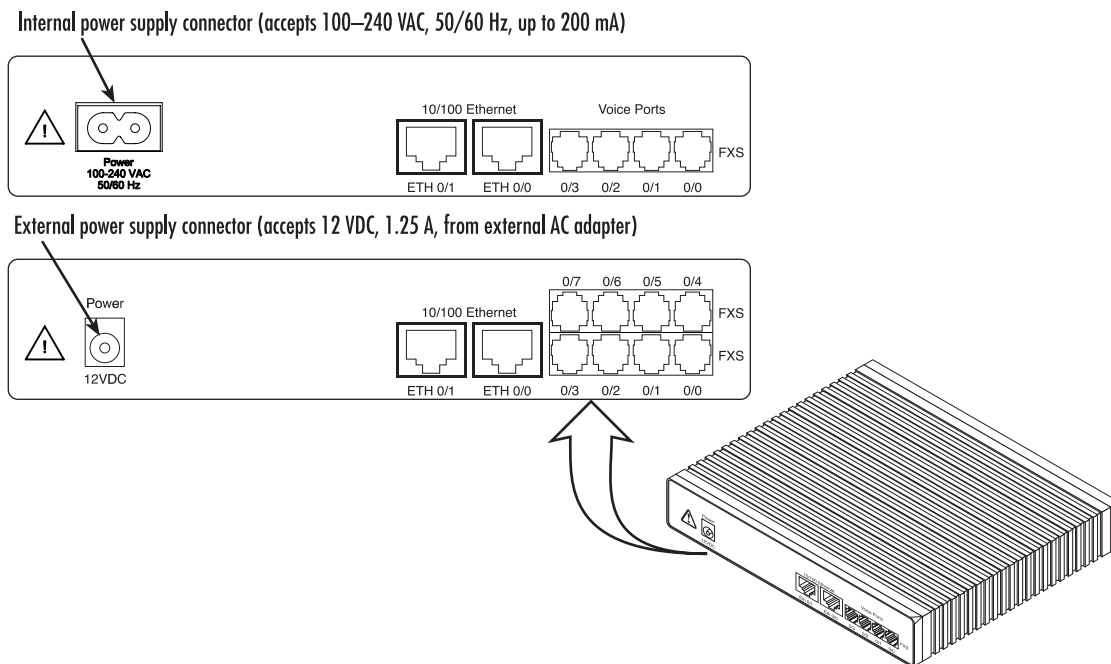

Figure 22. Power connector location on rear panel



The router power supply automatically adjusts to accept an input voltage from 100 to 240 VAC (50/60 Hz).

Verify that the proper voltage is present before plugging the power cord into the receptacle. Failure to do so could result in equipment damage.

3. Verify that the AC power cord included with your router is compatible with local standards. If it is not, refer to “[Contacting Patton for assistance](#)” on page 51 to find out how to replace it with a compatible power cord.
4. Connect the male end of the power cord to an appropriate power outlet.

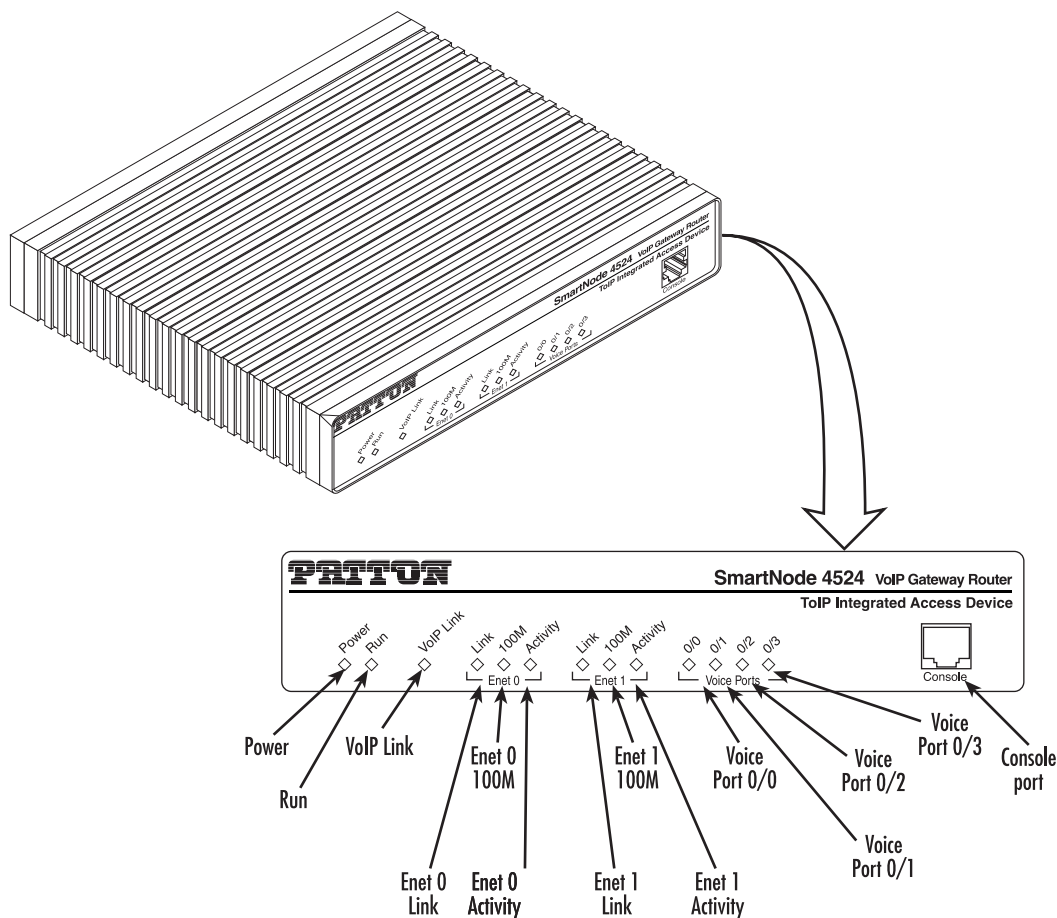

Figure 23. Router front panel LEDs and Console port locations (SmartNode 4524 shown)

5. Verify that the green *Power* LED is lit (see [figure 23](#)).

Congratulations, you have finished installing the SmartNode Gateway Router! Now go to chapter 4, “[Getting started with the SmartNode](#)” on page 38.

# Chapter 4 **Getting started with the SmartNode**

## **Chapter contents**

- Introduction ..... 39
- 1. Configure IP address ..... 40
  - Power connection and default configuration ..... 40
  - Connect with the serial interface ..... 40
  - Login ..... 41
  - Changing the IP address ..... 41
- 2. Connect the SmartNode to the network ..... 42
- 3. Load configuration ..... 42
- Bootloader ..... 43
  - Start Bootloader ..... 43
  - Start-up with factory configuration ..... 44
  - Load a new application image (SmartWare) via TFTP ..... 44
  - Load a new application image (SmartWare) via the serial link ..... 46
- Additional information ..... 46

## Introduction

This chapter leads you through the basic steps to set up a new SmartNode and to download a configuration.

Patton SmartNodes can be used for a wide variety of IP-based network applications. To support and ease the configuration of the SmartNodes configuration, templates for the most important applications are available on the Patton server at [www.patton.com/voip](http://www.patton.com/voip).

The main steps for setting up a new SmartNode (as of release 2.00 or 2.10) are shown in [figure 24](#).

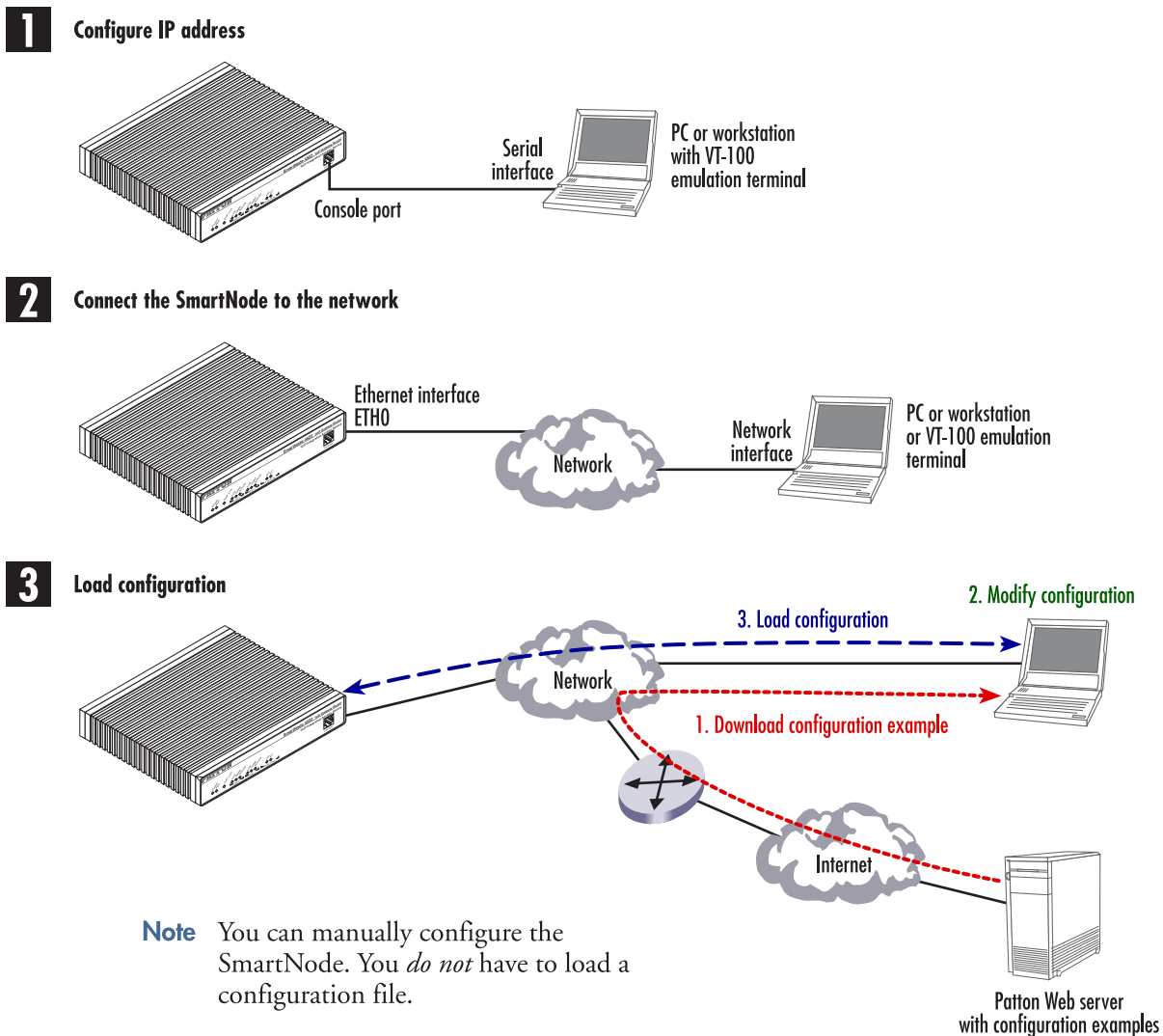

Figure 24. Steps for setting up a new SmartNode

## 1. Configure IP address



The Interconnecting cables shall be acceptable for external use and shall be rated for the proper application with respect to voltage, current, anticipated temperature, flammability, and mechanical serviceability.

### Power connection and default configuration

First the SmartNode must be connected to the mains power supply with the power cable. Wait until the 'Run' LED stops blinking and lights constantly. Now the SmartNode is ready.

The factory default configuration for the Ethernet interface IP addresses and network masks are listed in [table 8](#).

Table 8. Factory default IP address and network mask configuration

	IP Address	Network Mask
<b>Interface Ethernet 0 (ETH0)</b>	DHCP	DHCP
<b>Interface Ethernet 1 (ETH1)</b>	192.168.1.1	255.255.255.0

Both Ethernet interfaces are activated upon power-up.

If these addresses match with those of your network, go to section “[2. Connect the SmartNode to the network](#)” on page 42. Otherwise, refer to the following sections to change the addresses and network masks.

### Connect with the serial interface

The *Console* port is wired as an EIA-561, RS-232 port. Use the included Model 16F-561 adapter and cable (see [figure 25](#)) between the SmartNode's *Console* port and a PC or workstation's RS-232 serial interface. Activate the terminal emulation program on the PC or workstation that supports the serial interface (e.g. HyperTerm).

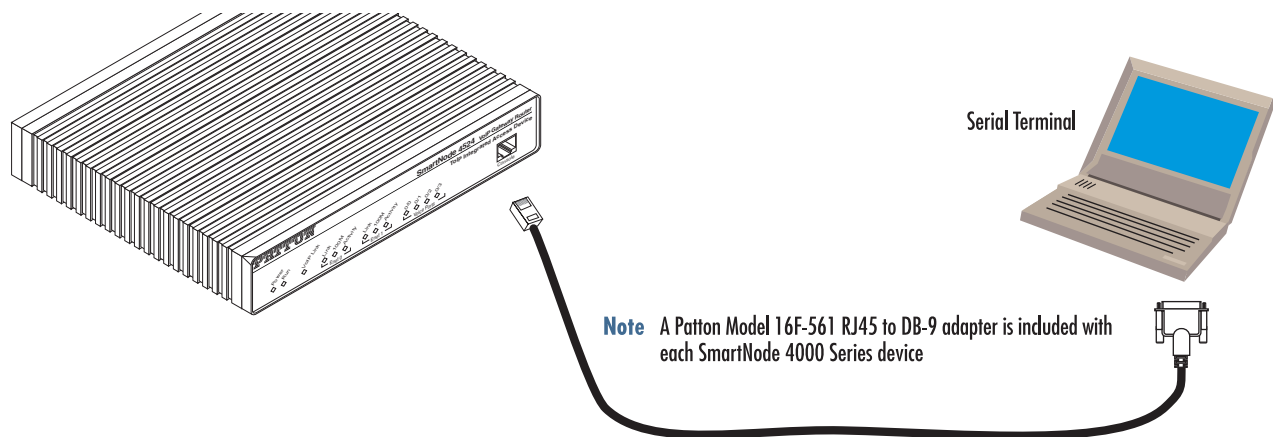

Figure 25. Connecting to the terminal

Terminal emulation program settings:

- 9600 bp
- no parity



- 8 bit
- 1 stop bit
- No flow control

## Login

Accessing your SmartNode via the local console port (or via a Telnet session) causes the login screen to display. Type the factory default login: *administrator* and leave the password empty. Press the *Enter* key after the password prompt.

```
login:administrator
password: <Enter>
172.16.40.1>
```

After you have successfully logged in you are in the operator execution mode, indicated by > as command line prompt. With the commands *enable* and *configure* you enter the configuration mode.

```
172.16.40.1>enable
172.16.40.1#configure
172.16.40.1(cfg)#
```

## Changing the IP address

Select the context IP mode to configure an IP interface.

```
172.16.40.1(cfg)#context ip router
172.16.40.1(ctx-ip)[router]#
```

Now you can set your IP address and network mask for the interface *eth0*. Within this example a class C network (172.16.1.0/24) is assumed. The IP address in this example is set to *172.16.1.99* (you should set this to an unused IP address on your network).

```
172.16.40.1(ctx-ip)[router]#interface eth0
172.16.40.1(if-ip)[eth0]#ipaddress 172.16.1.99 255.255.255.0
2002-10-29T00:09:40 : LOGINFO    : Link down on interface eth0.
2002-10-29T00:09:40 : LOGINFO    : Link up on interface eth0.
172.16.1.99(if-ip)[eth0]#
```

Copy this modified configuration to your new start-up configuration. Upon the next start-up the system will initialize itself using the modified configuration.

```
172.16.1.99(if-ip)[eth0]#copy running-config startup-config
172.16.1.99(if-ip)[eth0]#
```

The SmartNode can now be connected with your network.

## 2. Connect the SmartNode to the network



The Interconnecting cables shall be acceptable for external use and shall be rated for the proper application with respect to voltage, current, anticipated temperature, flammability, and mechanical serviceability.

Depending whether you connect the SmartNode to a host directly or via a hub or switch either straight-through wired or cross-over cables must be used (see figure 26).

**Note** The SmartNode 4520 Series is equipped with Auto-MDX Ethernet ports. Use straight-through or cross-over cables for host or hub/switch connections. The SmartNode 4110 will require the proper cable as it does not have the MDX feature.

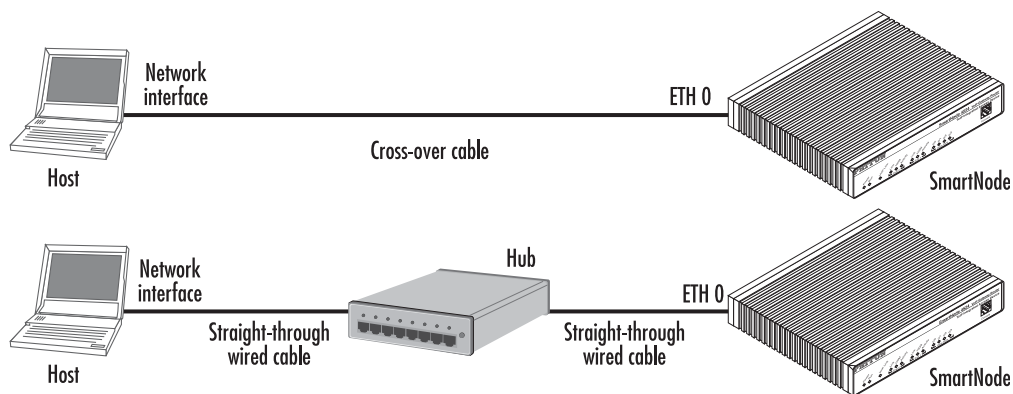

Figure 26. Connecting the SmartNode to the network

You can check the connection with the ping command to another host on the local LAN.

```
172.16.1.99(if-ip)[eth0]#ping <IP Address of the host>
```

Respectively from the host: *ping 172.16.1.99*

**Note** To ping outside your local LAN, you will need to configure the default gateway.

## 3. Load configuration

Download a configuration note to your PC from the support page of Patton's Inalp web server (<http://www.inalp.ch/en/support/confignotes/>) that matches your application. Adapt the configuration as described in the configuration note to your network (do not forget to modify the IP address) and copy the modified configuration to a TFTP server. The SmartNode can now load its configuration from this server.

In this example we assume the TFTP server on the host with the IP address 172.16.1.11 and the configuration named *SN.cfg* in the root directory of the TFTP server.

```
172.16.1.99(if-ip)[eth0]#copy tftp://172.16.1.11/SN.cfg startup-config
Download...100%
```

```
172.16.1.99(if-ip)[eth0]#
```

After the SmartNode has been rebooted the new start up configuration will be activated.

```
172.16.1.99(if-ip)[eth0]#reload
Running configuration has been changed.
Do you want to copy the 'running-config' to the 'startup-config'?
Press 'yes' to store, 'no' to drop changes : no
Press 'yes' to restart, 'no' to cancel : yes
The system is going down
```

## Bootloader

---

The bootloader ensures that basic operations, network access, and downloads are possible in case of interrupted or corrupted application image downloads. It also offers console access to the Bootloader and the capability for downloading application images (e.g. SmartWare) via the serial link of the console.

### Start Bootloader

To start the Bootloader, power on the SmartNode while pressing the reset button. Open a Telnet session to the SmartNode via one of the Ethernet interfaces, or open a CLI session via the console port (if available on the SmartNode). The login display will appear. Using the credentials *admin / patton*, log in to the SmartNode. The following prompt will be displayed:

```
RedBoot>
```

Type **help** to display an overview of the available commands.

### Start-up with factory configuration

Step	Command	Purpose
<b>1</b>	<b>RedBoot&gt; fis load</b>	Copies the SmartWare application image from the persistent memory (flash:) to the volatile memory (RAM) from where it will be executed.
<b>2</b>	<b>RedBoot&gt; go -s factory-config</b>	Starts the SmartWare application telling it to use 'factory-config' as startup configuration. You can also start-up with any other configuration available in the persistent memory (nvram:) by providing its name instead of 'factory-config'.

### Load a new application image (SmartWare) via TFTP

The following procedure downloads the application image (SmartWare) for the mainboard. See the note below on how to download the respective CLI description file.

Step	Command	Purpose
<b>1 optional</b>	<b>RedBoot&gt; ip_address -l</b> <i>local_ip_address</i> [/mask_len]	Sets the IP address and subnet mask of the Ethernet interface 0/0 which shall be used to receive the new application image. <i>mask_len</i> is the length of the network address (or the number of 1's within the subnet mask). See Note below.
<b>2 optional</b>	<b>RedBoot&gt; ip_address -g</b> <i>gateway</i>	Sets the IP address of the default gateway.
<b>3 optional</b>	<b>RedBoot&gt; ping -h</b> <i>tftp-server_ip_address</i>	Tests the connectivity to the TFTP server.
<b>4</b>	<b>RedBoot&gt; load -r -v -h</b> <i>host -b</i> <i>base_address file_name</i>	Downloads an application image into the volatile memory (RAM) from where the SmartNode could directly execute it. <i>host</i> : IP address of the TFTP server <i>base_address</i> : memory location where to store the application image. Use the default address 0x1800100 <i>file_name</i> : path and name of the file on the TFTP server. Note: use the image file that contains the whole application, not the image parts.
<b>5</b>	<b>RedBoot&gt; fis delete -n 1</b>	Deletes the first application image. Reply with 'y' to the confirmation request.
<b>6</b>	<b>RedBoot&gt; fis create</b>	Stores the downloaded application image to the permanent memory (flash:). Reply with 'y' to the confirmation request.
<b>7</b>	<b>RedBoot&gt; fis list -l</b>	Checks whether the image has been successfully stored, whether it is the desired Release and Build, and whether it is valid.

Step	Command	Purpose
8	RedBoot> go	Starts the application image that was downloaded into the volatile memory (RAM).

**Note** With the Bootloader, only the Ethernet interface 0/0 is available. The Bootloader applies the IP address, subnet mask, and default gateway that were last configured by the Bootloader itself or by another application (e.g. SmartWare). If an application configured the Ethernet interface 0/0 to use DHCP, the Bootloader will also use DHCP to learn the interface configuration. It can receive and apply the IP address, subnet mask, default gateway, and default (TFTP) server (transmitted as basic DHCP information 'Next server IP address').

**Note** This procedure does not download the respective CLI description file. Download it after starting up SmartWare with the following command:  
copy tftp://<tftp\_server\_address>/<server path>/b1 flash:

**Example:** Downloading and storing a new application image (SmartWare)

```
RedBoot> ip -l 172.16.40.98/19
RedBoot> ip -g 172.16.32.1
RedBoot> ping -h 172.16.32.100
Network PING - from 172.16.40.98 to 172.16.32.100
.....PING - received 10 of 10 expected

RedBoot> load -r -v -h 172.16.32.100 -b 0x1800100 /Sn4xxx/image.bin
Using default protocol (TFTP)
-
Raw file loaded 0x01800100-0x0199ca6b, 1689964 bytes, assumed entry at 0x01800100

RedBoot> fis delete -n 1
Delete image 1 - continue (y/n)? y
... Erase from 0x60030000-0x601cc974: .....
```

```
RedBoot> fis create
Use address 0x01800100, size 1684402 ? - continue (y/n)? y
... Erase from 0x60030000-0x601cb3ba: .....
... Program from 0x00011eec-0x00011ef4 at 0x60030000: .
... Program from 0x01800100-0x0199b4b2 at 0x60030008: .....
... Program from 0x00011eec-0x00011ef4 at 0x60030000: .
Image successfully written to flash

RedBoot> fis list -l
Id Address      Length  State      Description
  Entry        Load Addr      Version
-----
1  0x60030000  1693438  valid      SmartWare R2.10 BUILD28015
   0x01800100  0x01800100  V2.10

RedBoot> go
Starting 'SmartWare R2.10 BUILD28015' at 0x01800100 via 0x01800100
```

### Load a new application image (SmartWare) via the serial link

The Bootloader supports the 'X-Modem' and 'Y-Modem' protocols to download application images via the serial link of the console. Do the following to initiate the download:

Step	Command	Purpose
<b>1</b>	<b>RedBoot&gt; load -r -v -m { xmodem   ymodem } -b base_address</b>	Downloads an application image into the volatile memory (RAM) from where the SmartNode could directly execute it. 'xmodem' or 'ymodem': Specify the protocol to be used, X-Modem or Y-Modem <i>base_address</i> : memory location where to store the application image. Use the default address 0x1800100 Execute the above RedBoot command first, then start the transfer from the terminal program with the command 'Send file via X-Modem' (or similar).
<b>5</b>	RedBoot> fis delete -n 1	Deletes the first application image. Reply with 'y' to the confirmation request.
<b>6</b>	RedBoot> fis create	Stores the downloaded application image to the permanent memory (flash:). Reply with 'y' to the confirmation request.
<b>7</b>	RedBoot> fis list -l	Checks whether the image has been successfully stored, whether it is the desired Release and Build, and whether it is valid.
<b>8</b>	RedBoot> go	Starts the application image that was downloaded to the volatile memory (RAM).

**Note** This type of download takes about **25 minutes** since it uses a serial link at only 9600 bps.

### Additional information

For detailed information about configuring and operating guidance, set up procedures, and troubleshooting, refer to the *SmartNode Series SmartWare Software Configuration Guide* available online at [www.patton.com/manuals](http://www.patton.com/manuals).

## Chapter 5 **LEDs status and monitoring**

---

### **Chapter contents**

Status LEDs.....	48
------------------	----

## Status LEDs

This chapter describes SmartNode gateway router front panel LEDs. [Figure 27](#) shows SmartNode 4520 Series LEDs, [figure 28](#) on page 49 shows SmartNode 4110 Series LEDs. LED definitions are listed in [table 9](#) on page 50.

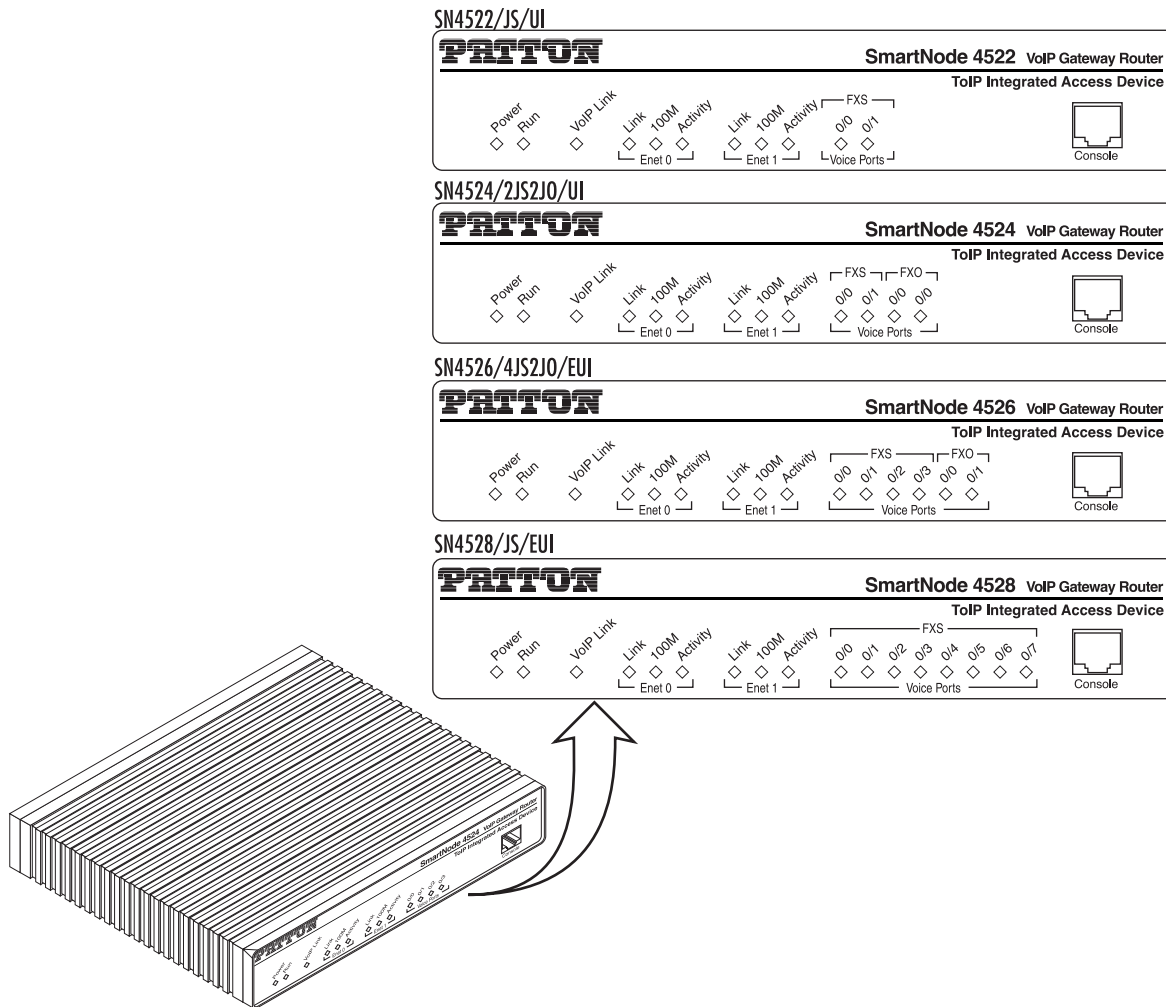

Figure 27. Examples of SN4520 Series front panels



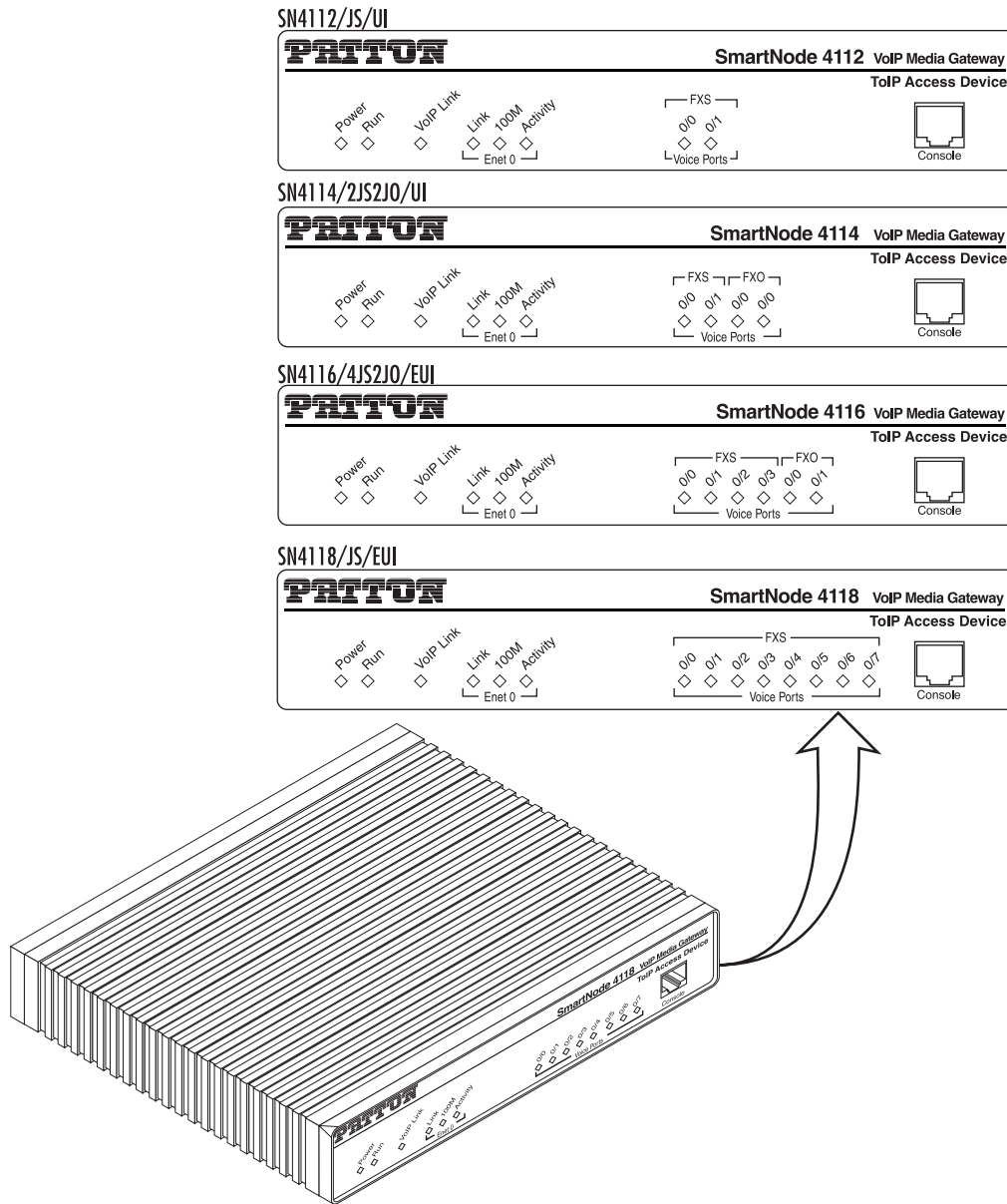

Figure 28. Examples of SN4110 Series front panels

Table 9. SmartNode LED Indications

LED	Description
<b>Note</b> If an error occurs, all LEDs will flash once per second.	
<b>Power</b>	When lit, indicates power is applied. Off indicates no power applied.
<b>Run</b>	When lit, indicates normal operation. Flashes once per second during boot (startup).
<b>VoIP Link</b>	When lit, indicates the gateway is registered on a gatekeeper, media gateway controller, associated to a remote unit, or has an active VoIP connection. Off indicates the unit is not configured or registered and has no active VoIP connection. Flashing green indicates that the unit is attempting or has failed to associate/register
<b>FXS</b> (each port)	Off indicates on-hook condition. Solid green when off-hook. Flashes to follow ring cadence.
<b>FXO</b> (each port)	Off indicates on-hook condition. Solid green when off-hook. Flashes to follow ring cadence.
<b>Ethernet</b> (each port)	<ul style="list-style-type: none"> <li>• <b>Link</b>: Lit when Ethernet link is up.</li> <li>• <b>100M</b>: On when 100-Mbps Ethernet is selected.</li> <li>• <b>Activity</b>: Flashes when data is received or transmitted from the unit to the LAN.</li> </ul>

# Chapter 6 **Contacting Patton for assistance**

## **Chapter contents**

- Introduction..... 52
- Contact information..... 52
- Warranty Service and Returned Merchandise Authorizations (RMAs)..... 52
  - Warranty coverage ..... 52
    - Out-of-warranty service ..... 52
    - Returns for credit ..... 52
    - Return for credit policy ..... 53
  - RMA numbers ..... 53
  - Shipping instructions ..... 53

## Introduction

---

This chapter contains the following information:

- “Contact information”—describes how to contact Patton technical support for assistance.
- “Warranty Service and Returned Merchandise Authorizations (RMAs)” —contains information about the RAS warranty and obtaining a return merchandise authorization (RMA).

## Contact information

---

Patton Electronics offers a wide array of free technical services. If you have questions about any of our other products we recommend you begin your search for answers by using our technical knowledge base. Here, we have gathered together many of the more commonly asked questions and compiled them into a searchable database to help you quickly solve your problems:

- Online support—available at [www.patton.com](http://www.patton.com)
- E-mail support—e-mail sent to [support@patton.com](mailto:support@patton.com) will be answered within 1 business day
- Telephone support—standard telephone support is available five days a week—from 8:00 am to 5:00 pm EST (1300 to 2200 UTC)—by calling +1 (301) 975-1007

## Warranty Service and Returned Merchandise Authorizations (RMAs)

---

Patton Electronics is an ISO-9001 certified manufacturer and our products are carefully tested before shipment. All of our products are backed by a comprehensive warranty program.

**Note** If you purchased your equipment from a Patton Electronics reseller, ask your reseller how you should proceed with warranty service. It is often more convenient for you to work with your local reseller to obtain a replacement. Patton services our products no matter how you acquired them.

### Warranty coverage

Our products are under warranty to be free from defects, and we will, at our option, repair or replace the product should it fail within one year from the first date of shipment. Our warranty is limited to defects in workmanship or materials, and does not cover customer damage, lightning or power surge damage, abuse, or unauthorized modification.

### *Out-of-warranty service*

Patton services what we sell, no matter how you acquired it, including malfunctioning products that are no longer under warranty. Our products have a flat fee for repairs. Units damaged by lightning or other catastrophes may require replacement.

### *Returns for credit*

Customer satisfaction is important to us, therefore any product may be returned with authorization within 30 days from the shipment date for a full credit of the purchase price. If you have ordered the wrong equipment or you are dissatisfied in any way, please contact us to request an RMA number to accept your return. Patton is not responsible for equipment returned without a Return Authorization.

### *Return for credit policy*

- Less than 30 days: No Charge. Your credit will be issued upon receipt and inspection of the equipment.
- 30 to 60 days: We will add a 20% restocking charge (crediting your account with 80% of the purchase price).
- Over 60 days: Products will be accepted for repairs only.

### **RMA numbers**

RMA numbers are required for all product returns. You can obtain an RMA by doing one of the following:

- Completing a request on the RMA Request page in the *Support* section at [www.patton.com](http://www.patton.com)
- By calling +1 (301) 975-1007 and speaking to a Technical Support Engineer
- By sending an e-mail to [returns@patton.com](mailto:returns@patton.com)

All returned units must have the RMA number clearly visible on the outside of the shipping container. Please use the original packing material that the device came in or pack the unit securely to avoid damage during shipping.

### *Shipping instructions*

The RMA number should be clearly visible on the address label. Our shipping address is as follows:

#### **Patton Electronics Company**

RMA#: xxxx

7622 Rickenbacker Dr.

Gaithersburg, MD 20879-4773 USA

Patton will ship the equipment back to you in the same manner you ship it to us. Patton will pay the return shipping costs.

# Appendix A **Compliance**

## **Chapter contents**

Compliance .....	55
EMC Compliance: .....	55
Safety Compliance: .....	55
PSTN Regulatory Compliance: .....	55
CE Declaration of Conformity .....	55
Authorized European Representative .....	55
Radio and TV Interference (FCC Part 15) .....	56
FCC Part 68 (ACTA) Statement (FXO Ports).....	56
Industry Canada Notice (FXO Ports).....	56

## Compliance

---

### **EMC Compliance:**

- FCC Part 15, Class A
- EN55022, Class A
- EN55024

### **Safety Compliance:**

- UL60950-1/CSA C22.2 No. 60950-1
- IEC 60950-1
- EN60950-1
- AS/NZS 60950-1

### **PSTN Regulatory Compliance:**

- FCC Part 68
- CS-03
- TBR 21
- AS/ACIF S002
- AS/ACIF S003

## CE Declaration of Conformity

---

We certify that the apparatus identified in this document conforms to the requirements of Council Directive 1999/5/EC on the approximation of the laws of the member states relating to Radio and Telecommunication Terminal Equipment and the mutual recognition of their conformity.

The safety advice in the documentation accompanying this product shall be obeyed. The conformity to the above directive is indicated by the CE sign on the device.

## Authorized European Representative

---

D R M Green

European Compliance Services Limited.

Oakdene House, Oak Road

Watchfield,

Swindon, Wilts SN6 8TD, UK

## Radio and TV Interference (FCC Part 15)

---

This equipment generates and uses radio frequency energy, and if not installed and used properly—that is, in strict accordance with the manufacturer's instructions—may cause interference to radio and television reception. This equipment has been tested and found to comply with the limits for a Class A computing device in accordance with the specifications in Subpart B of Part 15 of FCC rules, which are designed to provide reasonable protection from such interference in a commercial installation. However, there is no guarantee that interference will not occur in a particular installation. If the equipment causes interference to radio or television reception, which can be determined by disconnecting the cables, try to correct the interference by one or more of the following measures: moving the computing equipment away from the receiver, re-orienting the receiving antenna, and/or plugging the receiving equipment into a different AC outlet (such that the computing equipment and receiver are on different branches).

## FCC Part 68 (ACTA) Statement (FXO Ports)

---

This equipment complies with Part 68 of FCC rules and the requirements adopted by ACTA. On the bottom side of this equipment is a label that contains—among other information—a product identifier in the format US: AAAEQ##TXXXX. If requested, this number must be provided to the telephone company.

The method used to connect this equipment to the premises wiring and telephone network must comply with the applicable FCC Part 68 rules and requirements adopted by the ACTA.

If this equipment causes harm to the telephone network, the telephone company will notify you in advance that temporary discontinuance of service may be required. But if advance notice isn't practical, the telephone company will notify the customer as soon as possible. Also, you will be advised of your right to file a complaint with the FCC if you believe it is necessary.

The telephone company may make changes in its facilities, equipment, operations or procedures that could affect the operation of the equipment. If this happens the telephone company will provide advance notice in order for you to make necessary modifications to maintain uninterrupted service.

If trouble is experienced with this equipment, for repair or warranty information, please contact our company. If the equipment is causing harm to the telephone network, the telephone company may request that you disconnect the equipment until the problem is resolved.

Connection to party line service is subject to state tariffs. Contact the state public utility commission, public service commission or corporation commission for information.

## Industry Canada Notice (FXO Ports)

---

This equipment meets the applicable Industry Canada Terminal Equipment Technical Specifications. This is confirmed by the registration number. The abbreviation, IC, before the registration number signifies that registration was performed based on a Declaration of Conformity indicating that Industry Canada technical specifications were met. It does not imply that Industry Canada approved the equipment.

This Declaration of Conformity means that the equipment meets certain telecommunications network protective, operational and safety requirements. The Department does not guarantee the equipment will operate to the user's satisfaction. Before installing this equipment, users should ensure that it is permissible to be connected to the facilities of the local telecommunications company. The equipment must also be installed using an acceptable method of connection. In some cases, the company's inside wiring associated with a single line individual service may be extended by means of a certified connector assembly (telephone extension cord). The



customer should be aware that compliance with the above condition may not prevent degradation of service in some situations. Repairs to some certified equipment should be made by an authorized maintenance facility designated by the supplier. Any repairs or alterations made by the user to this equipment, or equipment malfunctions, may give the telecommunications company cause to request the user to disconnect the equipment. Users should ensure for their own protection that the ground connections of the power utility, telephone lines and internal metallic water pipe system, are connected together. This protection may be particularly important in rural areas.

## Appendix B **Specifications**

### **Chapter contents**

DSP.....	59
Voice connectivity .....	59
Connectivity.....	59
Voice processing (signalling dependent) .....	59
Fax and modem support.....	59
Voice signalling .....	60
Voice routing—session router.....	60
IP services.....	60
Management .....	61
Operating environment .....	61
Operating temperature .....	61
Operating humidity .....	61
System .....	61
Dimensions .....	61
Weight and power dissipation .....	61
Power supply .....	62
AC version .....	62
DC version .....	62
Identification of the SmartNode devices via SNMP.....	62

## DSP

---

One or two 4-channel DSPs

## Voice connectivity

---

2-wire Loopstart, RJ-11/12

Short haul loop 1.1 km @3REN

EuroPOTS (ETSI EG201 188)

Programmable AC impedance, feeding, and ring voltage; On-Hook Voltage 29VDC

Caller-ID Type-1 FSK and ITU V.23/Bell 202 generation

## Connectivity

---

2 10/100 Full Duplex/Autosensing Ethernet RJ-45

## Voice processing (signalling dependent)

---

Voice codes:

- G.711 A-Law/ -Law (64 kbps)
- G.726 (ADPCM 40, 32, 24, 16 kpbs)
- G.723.1 (5.3 or 6.3 kbps)
- G.729ab (8 kbps)
- Transparent pass through

G.168 echo cancellation

8 parallel voice connections

DTMF detection and generation

Carrier tone detection and generation

Silence suppression and comfort noise

Configurable dejitter buffer

Configurable tones (dial, ringing, busy)

Configurable transmit packet length

RTP/RTCP (RFC 1889)

## Fax and modem support

---

G.711 transparent FAX

Fax over IP (FoIP)

T.38 Fax relay (9.6 k, 14.4 k)

## Voice signalling

---

H.323v4

- RAS, H.225, H.245
- Fast-connect, early H.245
- Gatekeeper autodiscovery
- Alias registration
- Overlap sending
- Empty capability set (call transfer, hold)
- H.323v1 call transfer, hold

ISDN over IP (ISoIP)

- H.323 GW and GK compatible
- H.323 Annex M3
- ISDN/Q-SIG feature tunneling
- ISDN speech, audio and data (Fax Gr 4, UDI 64, RDI 64)

## Voice routing—session router

---

Local switching; Interface huntgroups

Routing Criteria

- Interface
- Calling/called party number
- Time of day, day of week, date
- ISDN bearer capability

Number manipulation functions

- Replace numbers; Add/remove digits
- Multiple remote gateways; PLAR

## IP services

---

IPv4 router; RIPv1, v2 (RFC 1058 and 2453)

Programmable static routes

ICMP redirect (RFC 792); Packet fragmentation

DiffServe/ToS set or queue per header bits

Pocket Policing discards excess traffic

802.1p VLAN tagging

IPSEC AH & ESP Modes

Manual Key; IKE optional

AES/DES/3DES Encryption

## Management

Industry standard CLI with local console (RJ-45, RS-232, 9600 bps, 8, N, 1), and remote Telnet access

TFTP configuration & firmware loading

SNMP v1 agent (MIB II and private MIB)

Built-in diagnostic tools (trace, debug)

Java™ Applet; HPOV Integration with NNM

## Operating environment

### Operating temperature

32–104°F (0–40°C)

### Operating humidity

5–80% (non condensing)

## System

CPU Motorola MPC859 operating at 50 MHz

Memory:

- 32 Mbytes SDRAM
- 4 Mbytes Flash

## Dimensions

7.3W x 1.6H x 6.1D in. (18.5H x 4.1W x 15.5D cm)

## Weight and power dissipation

See [table 10](#).

Table 10. SmartNode weight and maximum power specifications

SmartNode model	Weight	Maximum power dissipation
SN4112/SN4522	30.5 oz/500 g	6W
SN4114/SN4524	30.5 oz/500 g	8W
SN4116/SN4526	24.4 oz/400 g <sup>a</sup>	12W
SN4118/SN4528	24.4 oz/400 g <sup>a</sup>	15W

a. Excluding external power supply

## Power supply



The terminal block header to which the wires are secured provides the disconnect for the SmartNode. Take proper measures to ensure that it is not permanently fastened to the receptacle mounted on the chassis.

### AC version

Internal power supply 100–240 VAC, 50/60 Hz, 200 mA

### DC version

12 VDC, 1.25 A

**Note** Power is to be provided by an agency-approved external SELV source which provides reinforced insulation from the AC mains power and where the DC connector is the disconnect device. The source must have a rating of 12 VDC, 1.25 A.

## Identification of the SmartNode devices via SNMP

All SmartNode devices have assigned sysObjectID (.iso.org.dod.internet.mgmt.mib-2.system.sysObjectID) numbers (see [table 11](#)).

Table 11. SmartNode Models and their Unique sysObjectID

SmartNode Model	SysObjectID
SN4112-JS	.iso.org.dod.internet.private.enterprises.patton.products.sn4xxx.5 1.3.6.1.4.1.1768.2.4.5.5
SN4112-JO	.iso.org.dod.internet.private.enterprises.patton.products.sn4xxx.19 1.3.6.1.4.1.1768.2.4.5.19
SN4114-JS	.iso.org.dod.internet.private.enterprises.patton.products.sn4xxx.6 1.3.6.1.4.1.1768.2.4.5.6
SN4114-JO	.iso.org.dod.internet.private.enterprises.patton.products.sn4xxx.20 1.3.6.1.4.1.1768.2.4.5.20
SN4114-2JS2JO	.iso.org.dod.internet.private.enterprises.patton.products.sn4xxx.12 1.3.6.1.4.1.1768.2.4.5.12
SN4116-JS	.iso.org.dod.internet.private.enterprises.patton.products.sn4xxx.7 1.3.6.1.4.1.1768.2.4.5.7
SN4116-JO	.iso.org.dod.internet.private.enterprises.patton.products.sn4xxx.21 1.3.6.1.4.1.1768.2.4.5.21
SN4116-4JS2JO	.iso.org.dod.internet.private.enterprises.patton.products.sn4xxx.13 1.3.6.1.4.1.1768.2.4.5.13
SN4118-JS	.iso.org.dod.internet.private.enterprises.patton.products.sn4xxx.8 1.3.6.1.4.1.1768.2.4.5.8
SN4118-JO	.iso.org.dod.internet.private.enterprises.patton.products.sn4xxx.22 1.3.6.1.4.1.1768.2.4.5.22

Table 11. SmartNode Models and their Unique sysObjectID (Continued)

SmartNode Model	SysObjectID
SN4118-4JS4JO	.iso.org.dod.internet.private.enterprises.patton.products.sn4xxx.14 1.3.6.1.4.1.1768.2.4.5.14
SN4524-JS	.iso.org.dod.internet.private.enterprises.patton.products.sn4xxx.1 1.3.6.1.4.1.1768.2.4.5.1
SN4526-JS	.iso.org.dod.internet.private.enterprises.patton.products.sn4xxx.3 1.3.6.1.4.1.1768.2.4.5.3
SN4528-JS	.iso.org.dod.internet.private.enterprises.patton.products.sn4xxx.4 1.3.6.1.4.1.1768.2.4.5.4
SN4524-2JS2JO	.iso.org.dod.internet.private.enterprises.patton.products.sn4xxx.9 1.3.6.1.4.1.1768.2.4.5.9
SN4526-4JS2JO	.iso.org.dod.internet.private.enterprises.patton.products.sn4xxx.10 1.3.6.1.4.1.1768.2.4.5.10
SN4528-4JS4JO	.iso.org.dod.internet.private.enterprises.patton.products.sn4xxx.11 1.3.6.1.4.1.1768.2.4.5.11
SN4522-JO	.iso.org.dod.internet.private.enterprises.patton.products.sn4xxx.15 1.3.6.1.4.1.1768.2.4.5.15
SN4524-JO	.iso.org.dod.internet.private.enterprises.patton.products.sn4xxx.16 1.3.6.1.4.1.1768.2.4.5.16
SN4526-JO	.iso.org.dod.internet.private.enterprises.patton.products.sn4xxx.17 1.3.6.1.4.1.1768.2.4.5.17
SN4528-JO	.iso.org.dod.internet.private.enterprises.patton.products.sn4xxx.18 1.3.6.1.4.1.1768.2.4.5.18

According to [table 11](#), an SNMP get request to *.iso.org.dod.internet.mgmt.mib-2.system.sysObjectID* of a SmartNode 4112-JS device reads out a numeric OID of *1.3.6.1.4.1.1768.2.4.5.5*, which represents a SmartNode 4112 device. The mapping of the sysObjectID to each of the SmartNode model is realized with the SmartNode product identification MIB.

**IMPORTANT**

The SNMP agent running in SmartWare is SNMP version 1 (SNMPv1) compliant. SNMP version 2 (SNMPv2) and SNMP version 3 (SNMPv3) are not currently supported.

# Appendix C **Cabling**

---

## **Chapter contents**

Introduction.....	65
Serial console.....	65
Ethernet 10Base-T and 100Base-T.....	66
Analog FXS.....	68
Analog FXO.....	69



## Introduction

This section provides information on the cables used to connect the SmartNode and the interface cards to the existing network infrastructure and to third party products.



The Interconnecting cables shall be acceptable for external use and shall be rated for the proper application with respect to voltage, current, anticipated temperature, flammability, and mechanical serviceability.

## Serial console

The SmartNode can be connected to a serial terminal over its serial console port, as depicted in [figure 29](#).

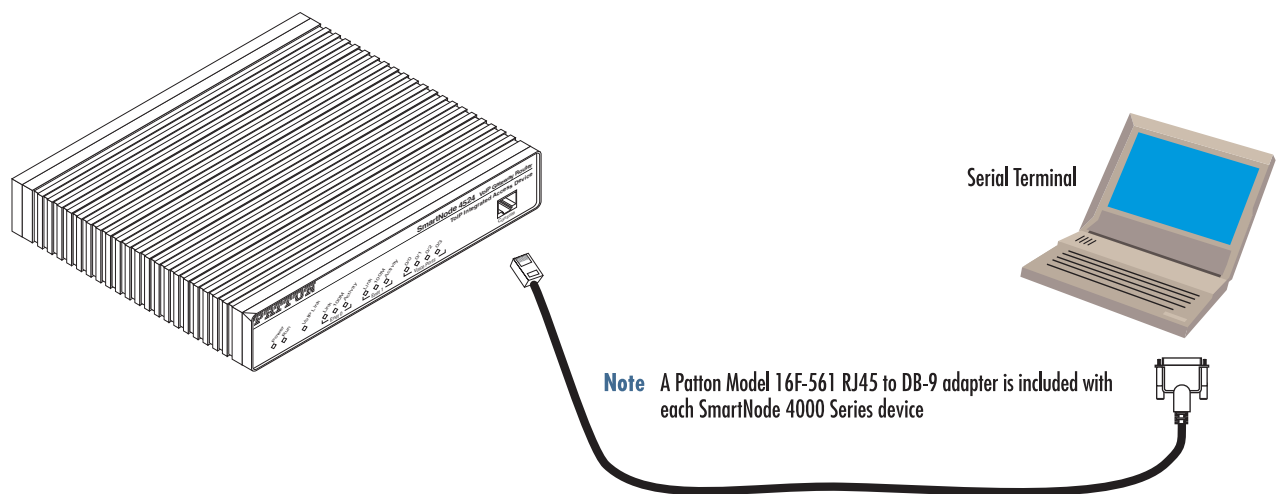

Figure 29. Connecting a serial terminal

**Note** See section “[Console port](#)” on page 71 for console port pin-outs.

## Ethernet 10Base-T and 100Base-T



The Interconnecting cables shall be acceptable for external use and shall be rated for the proper application with respect to voltage, current, anticipated temperature, flammability, and mechanical serviceability.

Ethernet devices (10Base-T/100Base-T) are connected to the SmartNode over a cable with RJ-45 plugs. Use a cross-over cable to a host, or a straight cable to a hub. See [figure 30](#) (host) and [figure 31](#) on page 67 (hub) for the different connections.

**Note** The SmartNode 4520 Series is equipped with Auto-MDX Ethernet ports. Use straight-through wired cables for host or hub/switch connections

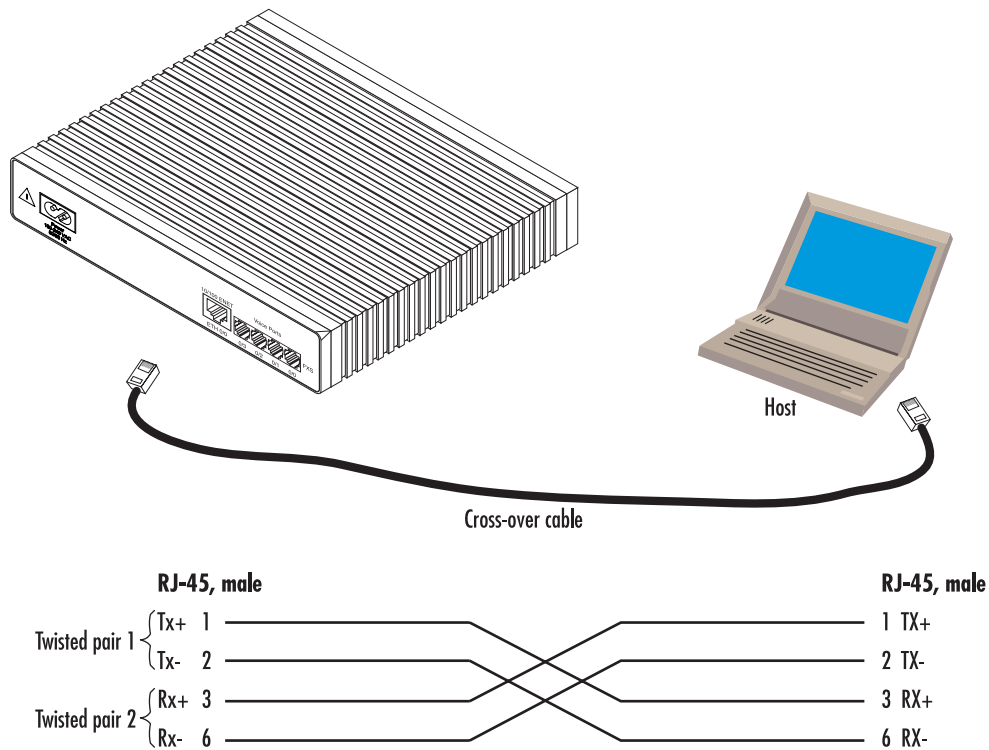
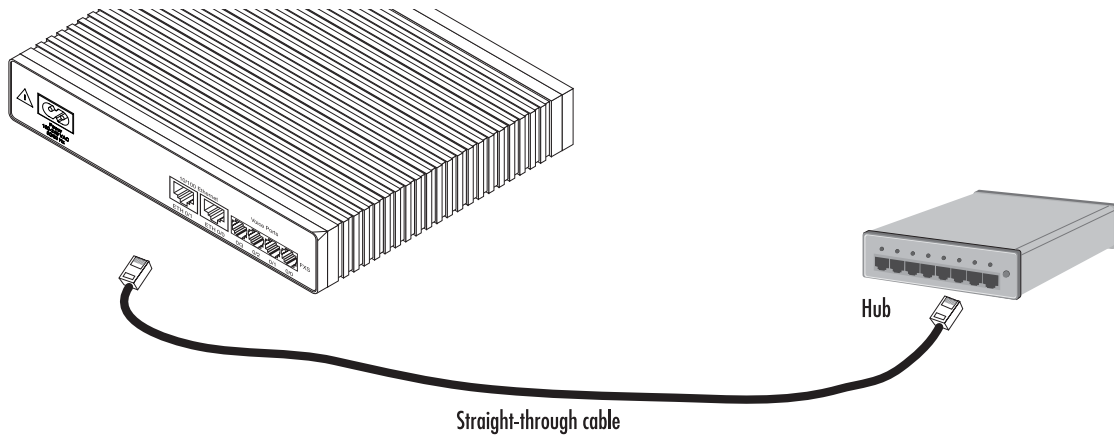

Figure 30. Ethernet cross-over



RJ-45, male		RJ-45, male	
Tx+	1	1	Rx+
Tx-	2	2	Rx-
Rx+	3	3	Tx+
Rx-	6	6	Tx-

Figure 31. Ethernet straight-through

## Analog FXS



The Interconnecting cables shall be acceptable for external use and shall be rated for the proper application with respect to voltage, current, anticipated temperature, flammability, and mechanical serviceability.

Applicable to SmartNodes equipped with FXS ports. The FXS ports are connected to analog terminals (phones, fax machines, answering machines) via cables terminated with RJ-11 connectors (see section “FXS port” on page 72 for details on port pinouts).

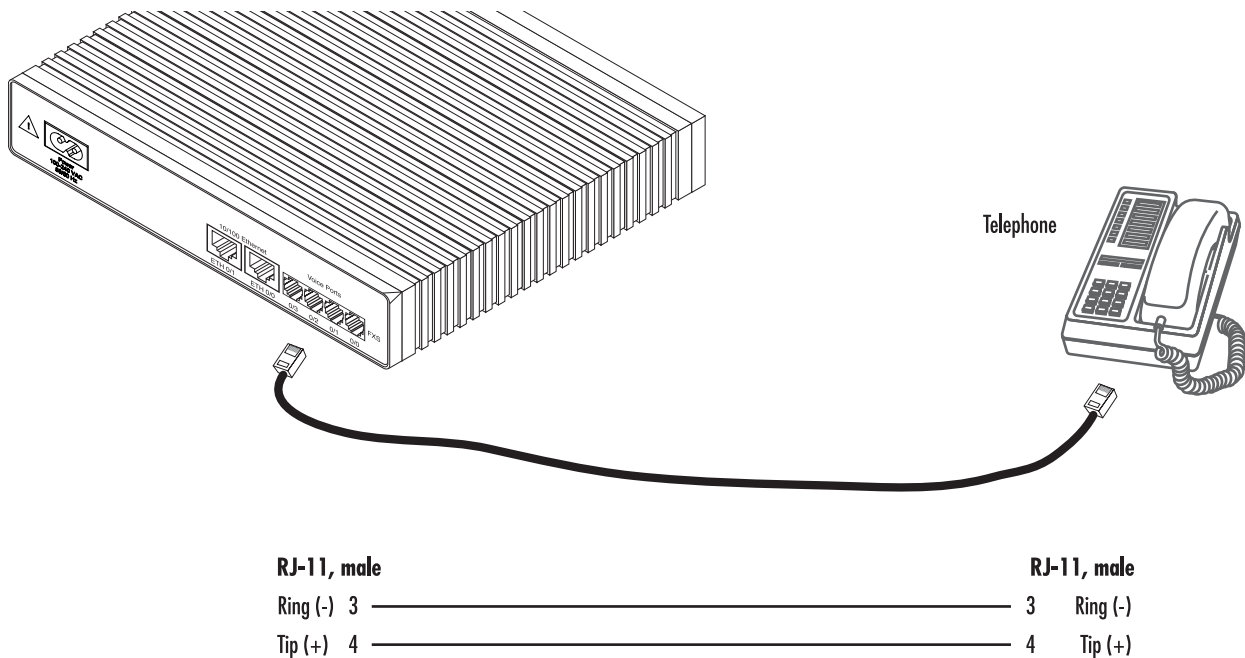

Figure 32. Connecting an FXS device

## Analog FXO



The Interconnecting cables shall be acceptable for external use and shall be rated for the proper application with respect to voltage, current, anticipated temperature, flammability, and mechanical serviceability.

Applicable to SmartNodes equipped with FXO ports. The FXO ports are connected to analog phone lines via cables terminated with RJ-11 connectors (see section “FXO port” on page 72 for details on port pinouts).

**Note** The phone line socket (connector type and pinout) available from the public network vary from country to country. Refer to technical information available from your local operator for additional cabling information.

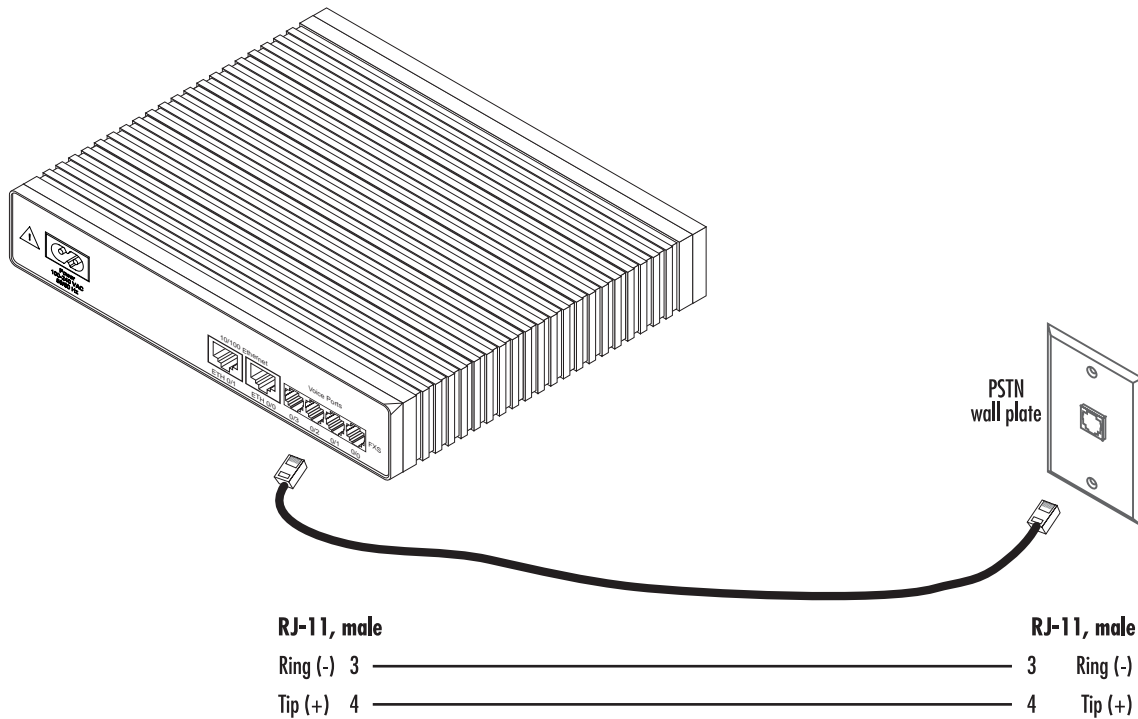

Figure 33. Connecting to an FXO line socket

## Appendix D **Port pin-outs**

---

### **Chapter contents**

Introduction.....	71
Console port.....	71
Ethernet 10Base-T and 100Base-T port .....	71
FXS port.....	72
FXO port .....	72

## Introduction

This section provides pin-out information for the ports of the SmartNode.

## Console port

**Configuration settings:** 9600 bps, 8 bits, no parity, no flow control

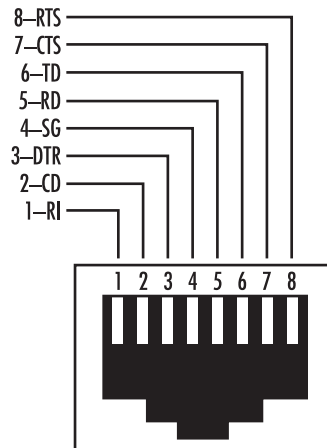

Figure 34. EIA-561 (RJ-45 8-pin) port

**Note** Pins not listed are not used.

## Ethernet 10Base-T and 100Base-T port

Table 12. RJ-45 socket

Pin	Signal
1	TX+
2	TX-
3	RX+
6	RX-

**Note** Pins not listed are not used.

## FXS port

---

The FXS ports use an RJ-11 connector with 6 positions. The middle two positions 3 and 4 are used according to [table 13](#).

Table 13. RJ-11 socket

Pin	Signal
3	Ring (-)
4	Tip (+)

**Note** Pins not listed are not used.

## FXO port

---

The FXO ports use an RJ-11 connector with 6 positions. The middle two positions 3 and 4 are used according to [table 14](#).

Table 14. RJ-11 socket

Pin	Signal
3	Ring (-)
4	Tip (+)

**Note** Pins not listed are not used.



# Appendix E **SmartNode 4110 Series factory configuration**

---

## **Chapter contents**

Introduction.....	74
-------------------	----

## Introduction

---

The factory configuration settings for SmartNode 4110 Series devices are as follows:

```
#-----#
#
# 4110 Series
# Factory configuration file
#
#-----#

ntp-client
ntp-client server primary 129.132.2.21 port 123 version 4

system
  ic voice 0
    low-bitrate-codec g729

context ip router

  interface eth0
    ipaddress dhcp
    tcp adjust-mss rx mtu
    tcp adjust-mss tx mtu

port ethernet 0 0
  medium auto
  encapsulation ip
  bind interface eth0 router
  no shutdown
```

# Appendix F **SmartNode 4520 Series factory configuration**

---

## **Chapter contents**

Introduction.....	76
-------------------	----

## Introduction

---

The factory configuration settings for SmartNode 4520 Series devices are as follows:

```
#-----#
#
# 4520 Series
# Factory configuration file
#
#-----#

dns-relay
sntp-client
sntp-client server primary 129.132.2.21 port 123 version 4

system

    ic voice 0
        low-bitrate-codec g729

profile napt NAPT

profile dhcp-server DHCP
network 192.168.1.0 255.255.255.0
include 1 192.168.1.10 192.168.1.99
lease 2 hours
default-router 1 192.168.1.1
domain-name-server 1 192.168.1.1

context ip router

    interface eth0
        ipaddress dhcp
        use profile napt NAPT
        tcp adjust-mss rx mtu
        tcp adjust-mss tx mtu

    interface eth1
        ipaddress 192.168.1.1 255.255.255.0
        tcp adjust-mss rx mtu
        tcp adjust-mss tx mtu

context ip router
    dhcp-server use DHCP

port ethernet 0 0
    medium auto
    encapsulation ip
    bind interface eth0 router
    no shutdown

port ethernet 0 1
    medium auto
    encapsulation ip
    bind interface eth1 router
    no shutdown
```

# Appendix G **Installation checklist**

---

## **Chapter contents**

Introduction.....	78
-------------------	----

## Introduction

This appendix lists the tasks for installing a SmartNode 4520 or 4110 Series router (see [table 15](#)) . Make a copy of this checklist and mark the entries as you complete each task. For each SmartNode 4520 or 4110 Series router, include a copy of the completed checklist in your site log.

Table 15. Installation checklist

Task	Verified by	Date
Network information available & recorded in site log		
Environmental specifications verified		
Site power voltages verified		
Installation site pre-power check completed		
Required tools available		
Additional equipment available		
All printed documents available		
SmartWare release & build number verified		
Rack, desktop, or wall mounting of chassis completed		
Initial electrical connections established		
ASCII terminal attached to console port		
Cable length limits verified		
Initial configuration performed		
Initial operation verified		