



Slim Key Board



User manual

Welcome,

we congratulate you to good buy code keyboard "**SlimKeyBoard**". This keyboard manage widely satisfy your need management codes for competence entry into object. Code keyboard can work separately or in connection with SlimDoorPhone.

Separate code keyboard is connect on source 12V (DC/AC) and contain one double throw contact. To control relay is possible use as far as 10 codes. Further is equipped input for Exit button and switch-on/switch-off heating on board. keyboard is programmed by force of keyboard, or by force of USB cable from PC.

At connection keyboard with doorphone SlimDoorPhone by special cable connect to programming connector. Code keyboard then makes it possible to dial phone numbers from SlimDoorPhone, door phone hang up, by Exit button control relay in SlimDoorPhone and use by other 10 codes to control relay in SlimDoorPhone.

Table of contents

1	BASIC DESCRIPTION	4
1.1	FEATURES	4
2	INSTALL CODE KEYBOARD	5
2.1	MONTAGE AND CONNECT SLIMKEYBOARD	5
2.1.1	<i>Description of keyboard</i>	5
2.1.2	<i>Open keyboard</i>	5
2.1.3	<i>Wall mounting and cables connection</i>	6
2.1.4	<i>connecting and control elements</i>	7
2.1.5	<i>Final enclosure SlimDoorPhone</i>	8
2.2	CONNECT THE KEYBOARD	9
3	SLIMKEYBOARD SERVICES	10
3.1	SIGNALLING OVERVIEW	10
3.2	VISITOR AT THE DOOR.....	10
3.2.1	<i>Separate keyboard</i>	10
3.2.2	<i>Keyboard connection with SlimDoorPhone</i>	10
3.3	PERSON INSIDE OBJECT	11
3.3.1	<i>Exit button - separate keyboard</i>	11
3.3.2	<i>Exit button - connected with SlimDoorPhone</i>	11
3.3.3	<i>Control from SlimDoorPhone</i>	11
4	PARAMETER PROGRAMMING	12
4.1	PROGRAMMING FROM BUTTONS ON KEYBOARD	12
4.1.1	<i>Entering programming mode</i>	12
4.1.2	<i>Parameter programming</i>	12
4.2	INSTALL PROGRAM SLIMKEYSET	12
4.3	PROGRAMMING FROM A PC – SLIMKEYSET PROGRAM	13
5	PARAMETER DESCRIPTION	14
5.1	ACCESS CODES	14
5.2	RELAY	15
5.3	BASIC PARAMETERS	16
5.4	PRESETTING AND DELETING	17
5.1	OVERVIEW OF PARAMETERS	18
6	TECHNICAL PARAMETERS	19
6.1	ELECTRICAL PARAMETERS	19
6.1	MECHANICAL DIMENSIONS	19
7	VRTACÍ ŠABLONA	20

1 Basic description

1.1 Features

- compact very thin modulus with assembly on plaster without the need of other mechanical part possibility
- connection door phone SlimDoorPhone with second relay
- possibility connect lock for open door
- modes of relay (1 impulse, 2 impulses and switch on / switch off)
- exit button
- 10 passwords code of lock for relay in keyboard
- 10 passwords code of lock for relay in SlimDoorPhone
- optional time among press of button at set code
- optional time closure of relay different for control from keyboard, for control from exit button and different for control from SlimDoorPhone
- programming it is possible from keyboard further direct interface to personal computer (USB cable) integrated heating printed circuit
- switch-on/switch-off signalling LED
- switch-on/switch-off acoustic signalling

2 Install code keyboard

SlimKeyBoard is mechanically compact unit, wall-mounted by force of two screws . Bottom and upper forehead is bonded special cement at production, therefore please put in enhanced focus dismounting and mounting code keyboard.

2.1 Montage and connect SlimKeyBoard

2.1.1 Description of keyboard

1. Foil keyboard
2. symbol **X** cancel executing instructions and in case connection with SlimDoorPhone hooks telephone line
3. symbol **key** you press always before choice code for closure relay, if enter numeric combination without previous press symbol keys, so this combination is taking like dial of numbers from connected SlimDoorPhone, in case that the there's not connected, so will not execute nothing.
4. hole for special key for opening cover of keyboard
5. optical signalisation LED

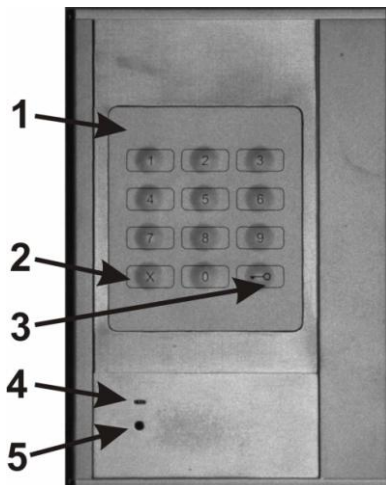

2.1.2 Open keyboard

1. Part of package is special tool, which use to push back interlocking spring. Tool push back what deepest as it is schematic on picture
2. panel with keyboard shift in direction schematic on picture
3. panel with keyboard in upside doorphone will take away in direction schematic on picture



2.1.3 Wall mounting and cables connection

Wall mounting does by two screws, it depends on basis. Into a wall, beton and stone will carry out by force of plug 6mm or 8mm, if background is wood or metal plate, then use special wood screw further to designate, if is wall from metal, then is necessary to the drilled hole cut out winding. To easy assembly is at the end hereof instruction (pgs .21) **drill template**.

Lead-in cable goes through third (bigger) hole and connect on screw connectors.

Keyboard is **powered 12V** namely within the range alternating voltage min. 10VAC - max. 15VAC or direct-current voltage min. 12VDC max. - 18VDC. Load hereof power supply it depends on connected electric lock (0,5A – 1,0A), in case switch-on heating board this current will rise about 150mA. Practically mostly will satisfy alternate power supply 12V/1A.

Wiring **clamp switch contact** is schematic on pictur Labelling "**NO**" means inactive open contact, "**COM**" means common pin (middle) and "**NC**" means inactive close contacts. Switch contact is galvanic isolated from other circuit of keyboard. Variants of connection lock be on picture.

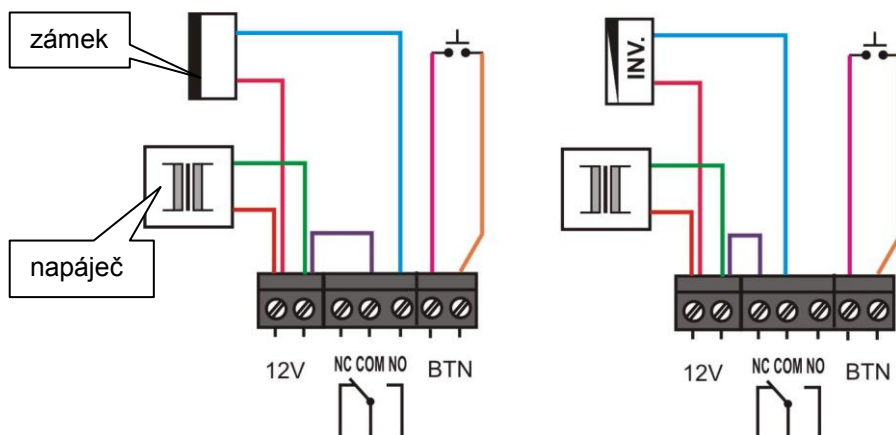
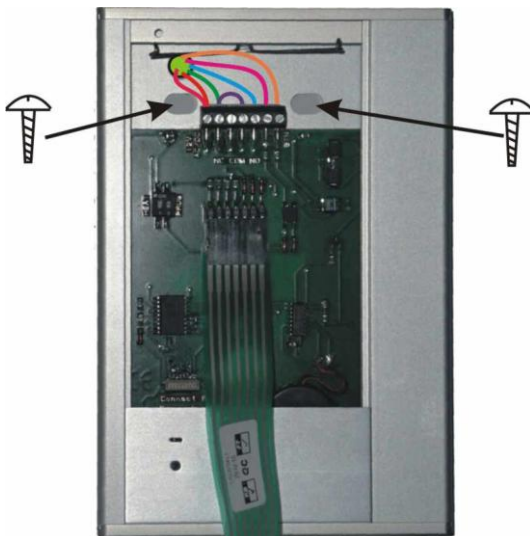

Connection cables and wiring standard and inverse lock

.On clamp on the right is connected **Exit button**. Lead to button can be up to 100m, is connected in current loops with separation by optocoupler. Button it is possible set in programme like switch on or switch off as well as is adjustable time press buttons after which will execute closure lock.

USB cable connection for programming from personal computer. By force of special converter, which galvanic separate SlimKeyboard from PC, can be adjust and check setting of all parameters in SlimKeyboard. To setting parameters serves program SlimKeySet for gantry Windows, starting with version W98SE by reason of driveru for USB port.

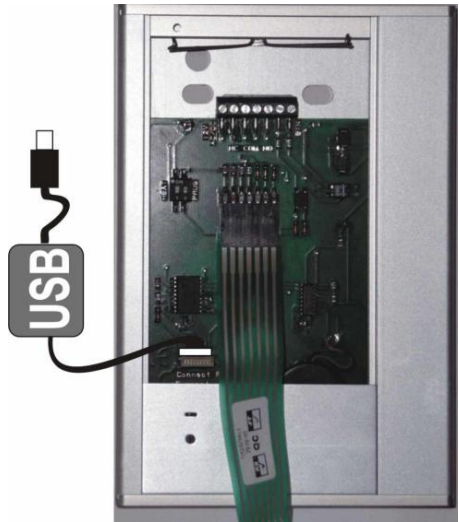

2.1.4 connecting and control elements

1. Switch marked **HEAT** switch on **heating** whole board SlimKeyboard so will prevent condensing humidity and through dehumidification.
2. Switch marked **PROG** make for switch - over SlimKeyboard to the programming mode



switch on = function aktive

3. Connector for connection foil keyboard
4. Connector for connection USB cable for programming from PC and for cable connection enabling connection SlimDoorPhone

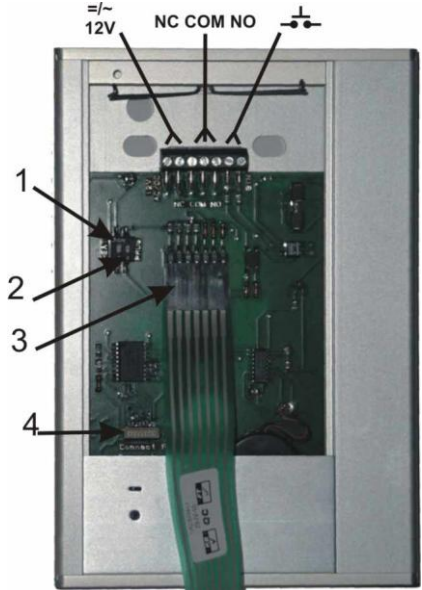

Heating of board has two positive function, partly warming electronics in winter, at temperatures below -20st (most parts with extensive temperature limit has guaranty characteristics from -20st) and partly at outdoor installation at intense change temperatures and higher atmospheric humidity at switch - on heating give out to condensing waters onboard keyboard and be as warranted his reliable function.

2.1.5 Final enclosure SlimDoorPhone

Closure keyboard SlimKeyBoard will carry out opposite way like opening.

1. special tool push back what deepest as it is schematic on picture
2. modulus keyboard push back on backstop in SlimKeyBoard
3. and in direction arrow keys push in below upper forehead SlimKeyBoard, spring snap and tool take out

Attention before shut assure, that the isn't keyboard in mode programming and in case connection SlimDoorPhone, that the link in connecting cable.



2.2 Connect the Keyboard

Keyboard work as separate code lock, he has connection power supply 12V, input for departure button and one relay with change-over contact. In case connection by special cable keyboard with SlimDoorPhone characteristics those code lock expand and keyboard can be use not only to control relay in keyboard, but relay in doorphone SlimDoorPhone contol too and use so 10 codes for one and 10 codes for second relay. Further it is possible keyboard use to dialling numbers. Exit button can control one or the other relay and relay in keyboard it is possible control from phone during conversation too (*parameter.30*). Code lock for relay in SlimDoorPhone from buttons stays conserved.

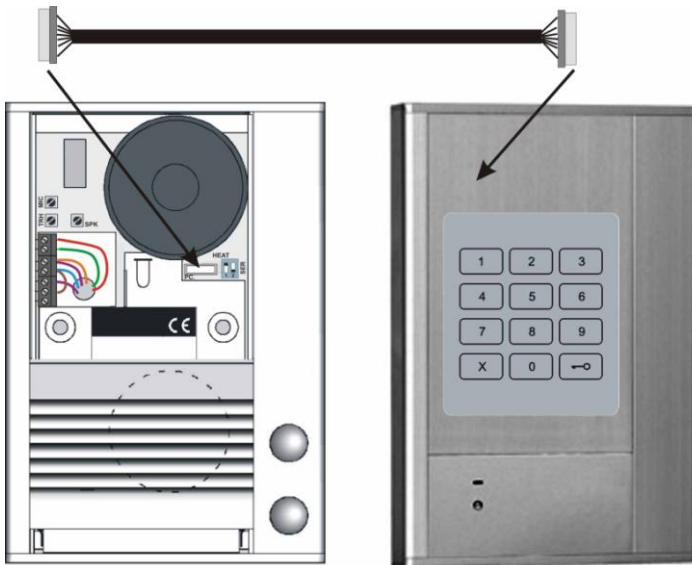

Connection by special cable is make that way will you use programming connectors 8pin. To programming from PC is usings same USB cable USB-KAB and program SlimDPset is in new version 2010 equipped also by program for setting keyboard.

To basic function is necessary have connected to **SlimDoorPhone telephone line** and to keyboard 12V. 12V for heating board and power supply of relay in SlimDoorPhone can use from same source and it is possible use also for power supply of locks. Recommended is use low power locks.

The choice is entered by gradual pressing of buttons with digits. Firstly the key symbol must be pressed to enter a password. When pressing **X**, the guard will hang up.

ATTENTION: at connection keyboard with doorphone **isn't** need apply to exchanges Siemens **BestBox!!!**

3 SlimKeyBoard services

3.1 Signalling overview

Code keyboard acoustic and optical signalling operation. These signalling can be separately switch off or switch on.

Condition	Tones	LED
Press button	—■—	—■—
Confirm	—■—	—■—
Error	—■—■—■—	—■—■—■—
Programming mode	—■—■—■—■—■—■—	-
Connection SlimDoorPhone and be missing 12V	—■—■—■—■—■—	-
Programming from PC	-	—■—■—■—

3.2 Visitor at the door

3.2.1 Separate keyboard

Separate keyboard makes it possible use 10 codes for closure relay and connect Exit button. To activation relay (opening door) visitor have to know at least one of 10 input code and before this combination press symbol key.

In SlimKeyBoard it is possible choose for relay one of three modes, first makes it possible after activation correct code relay switch on to adjusted time and relay then switch off. Second mode makes it possible switch on two consecutive impulses, where it is possible set closure time and time between impulses. Third mode is bistable it means. that one command e.g . switch on and next command switch off, this state is lasting and every correct evaluation code negate previous state.

To valid evaluation code must be time between press separate buttons less than adjusted time (par.45).

3.2.2 Keyboard connection with SlimDoorPhone

Keyboard can connect through SlimDoorPhone 1, 2 or 4 buttons. Expand so possibilities, because can be from keyboard control how relay in keyboard (10 codes) so relay in doorphone SlimDoorPhone (10 codes).

Keyboard has two function button

- **symbol key** = after pressing is numeric combination understanding always like

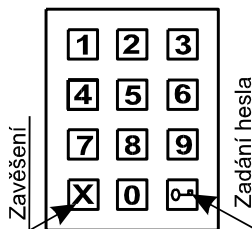

combination for control relays

- **symbol X** = after pressing doorphone promptly hang up and next cancel action setting numeric combination.

Arrival on buttons votes number, like on phone – between press of button must be time less than given to setting appropriate parameter (par.45) in keyboard, after this time doorphone pick up and dial engaged telephone number.

To valid evaluation code must be time between press separate buttons less than adjusted time (par.45).

3.3 Person inside object

Person inside object is conceptional person which already pass through door to the object or is in phone connection with SlimDoorPhone.

3.3.1 Exit button - separate keyboard

Keyboard makes it possible connect Exit button. This button generally arranges from second parties door and make for opening door at departure men from object. Button is connected in circuit current loop and makes it possible connect as button closing so and button with disconnecting contact (par.44). Further can set time of hold button than will evaluate pressing (par.43). Closure time of relay is adjustable different from closure time evoked from code keyboard (par.33)

3.3.2 Exit button - connected with SlimDoorPhone

At connection with doorphone SlimDoorPhone has button same possibilities like in separate keyboard (chap.3.3.1). In addition can set that the Exit button controls relay in SlimDoorPhone (par.42). Closure time of relay in SlimDoorPhone is obey setting closure time of relay in SlimDoorPhone.

3.3.3 Control from SlimDoorPhone

At connection keyboard with SlimDoorPhone is possible control at telephone connection relay in keyboard. At parameter setting in SlimDoorPhone in sections relay is code for closure relay in keyboard (in basic setting = 77). After choice hereof code is control relay in keyboard. Control of relay consist of time before closure relay (par.35) and from closure time relay (par.34). This way is enabled extend function gradual open door. In doorphone SlimDoorPhone set code for closure relay same as code for closure relay in keyboard. After choice hereof code switch on relay in SlimDoorPhone, with time before closure relay (par.35) in keyboard set delay before closure relay in keyboard, after this time switch on relay in keyboard (second door).

4 Parameter programming

4.1 Programming from buttons on keyboard

4.1.1 Entering programming mode

Change over switch **PROG** to the position "on" cross over keyboard to the programming mode, sound programming tone and blink LED. After change over switch back to position "off" programming will finish.

4.1.2 Parameter programming

Initial level for programming is announces by programming tone, to the hereof state is keyboard returns always after a period of time (6sec) however are started program anything.

At programming is occur two sorts of parameters. In part are that parameters **with constant duration** – of those is most, then is programming confirmed and parameter written into always immediately after fulfilment obligatory duration **confirmation tone** and partly parameters **with varying length** (*parameter 1 and 2*), then **take place** confirmation and write parameter when after a period of time inactivity (6 sec) or it is possible confirm writing combination pressing sign keys. Even notice, at these parameters is maximum longitude 8 digits, after fill those longitude already not waiting and parameter is written immediately.

If during programming enter number (sign) which is its unused range, so immediately doorphone transmit **error tone**, parameter don't write down, nor yet will not change, keyboard cross into initial level and is possible repeat setting parameter, or program another parameter.

4.2 Install program SlimKeySet

Programme SlimKeySet be determined to OS Windows namely from version W98SE up to Windows 7. Installer you completion easy installation and icon of programme show on desktop. Programme SlimProgramSet includes two programs: SlimDPset and SlimKeySet.

To communication with keyboard is using USB cable and that requires driver USB. This driver is on CD , or on our WEBu [www.alphatech .cz](http://www.alphatech.cz) .

Procedure is such, that the to the PC plug in USB cable, PC you invite to setting path to driveru - care don't let driver install automatically, but by hand enter path to driveru. Then you must agree with it, that the isn't digitally signed and installation will pass. In this moment have you got everything prepared on programming SlimKeyBoard.

Rem cable USB for programming SlimKeyBoard is same as cable for programming SlimDoorPhone.

4.3 Programming from a PC – SlimKeySet program

To setup the unit from a PC you will require a special USB tool cable, available separately, and must first install the USB driver and SlimKeySet software. Refer to the CD for more details. The unit must also be connected to the 12V.

Procedure:

- Connect the Keyboard to the 12V
- Connect the unit to the PC with the USB tool cable.
- Run the SlimKeySet program. The unit will enter PC programming mode and doesn't matter on position switch PROG, PC programming has priority.

Refer to the SlimKeySet manual for more details

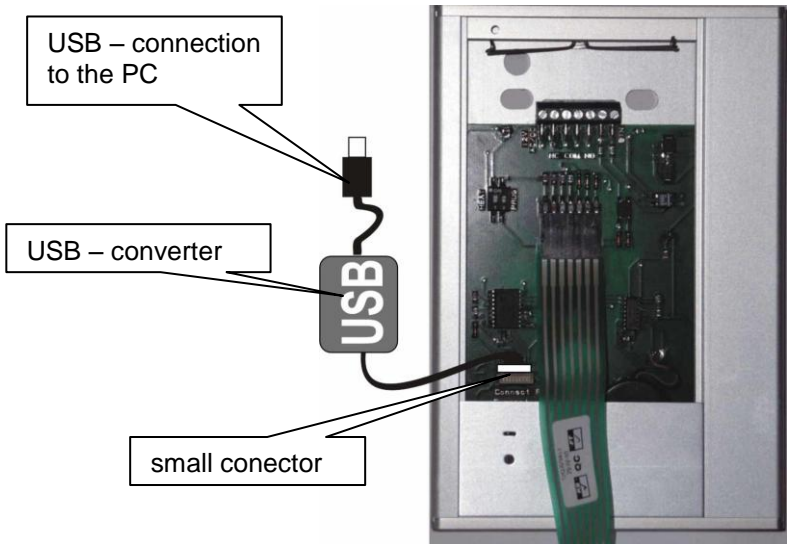

5 Parameter description

5.1 Access codes

Parameter	Value	Description	Default
1	p hh...	Access code hh in sequence p for closure relay in keyboard	-

p – number of sequence (memory) [0-9]

hh – Access code for closure relay 2 - 8 gigits, for storage. Delete is make by pressing combination 1 p and access code is deleted. For quickly programming is possible pres symbol key.

Example write access code:

programming tone **1 1 357** waiting to confirm tone 6sec, **confirm** and programming tone

programming tone **1 2 4477 "key" confirm** and programming tone (symbol key accelerate programming access code)

programming tone **1 3 12345678 confirm** and programming tone (at longitudeof access code 8= maximal, don't waiting to confirm),

Example delete access code:

programming tone **1 1** to confirm tone 6sec, **confirm** and programming tone

programming tone **1 2 "key" confirm** and programming tone (symbol key accelerate delete access code)

Parameter	Value	Description	Default
2	p hh...	Access code hh in sequence p for closure relay in SlimDoorPhone	-

p – number of sequence (memory) [0-9]

hh – Access code for closure relay 2 - 8 gigits, for storage. Delete is make by pressing combination 1 p and access code is deleted. For quickly programming is possible pres symbol key.

Example write access code:

programming tone **2 1 357** waiting to confirm tone 6sec, **confirm** and programming tone

programming tone **2 2 4477 "key" confirm** and programming tone (symbol key accelerate programming access code)

programming tone **2 3 12345678 confirm** and programming tone (at longitudeof access code 8= maximal, don't waiting to confirm),

Example delete access code:

programming tone **2 1** to confirm tone 6sec, **confirm** and programming tone

programming tone **2 2 "key" confirm** and programming tone (symbol key accelerate delete access code)

5.2 Relay

Parameter	Value	Description	Default
31	m	Relay working in mode m	1

m – mode of relay [1 - 3]

m=1 mode **switch** - switch on by command or by password to adjusted time (using for electric lock, open gate ...)

m=2 mode **two impulses** - switch on by command or by password on adjusted time, past adjusted time is switch off and again switch on to adjusted time (using electric movable gates - mode wicket)

m=3 mode **on- off** one command e.g . switch on, and next switch off, every command negate previous state without time limitation
Rem after power failure is always switch off (like TV and etc.)

Parameter	Value	Description	Default
32	rr	Relay closing time rr [sec] - command evoked from keyboard	05
33	ss	Relay closing time ss [sec] - command evoked from Exit button	05
34	tt	Relay closing time tt [sec] - command evoked from SlimDoorPhone	05

rr / ss / tt – duration of relay closing [2 digits 00-99]

Combination 00 means time 0,5sec

Parameter	Value	Description	Default
35	vv	Time vv [sec] before closure relay - command evoked from SlimDoorPhone	0

vv – Time vv before closure relay [2 digits 00-99]

Combination 00 means time 0,5sec

Control relay from SlimDoorPhone consist of time before closure relay **vv** and from time closure of relay tt. This way is enabled set function gradual opening door. In doorphone SlimDoorPhone set code for closure relay equal code for closure relay in keyboard. After choice hereof code switch on relay in SlimDoorPhone, time before closure relay **vv** in keyboard set delay before closure relay in keyboard, after this time switch on relay in keyboard (second door).

Parameter	Value	Description	Default
36	dd	Time between 2 impulses [sec]	05

dd – duration of delay between 2 impulses of relay [2 digits 00-99]
Combination 00 means time 0,5sec

5.3 Basic parameters

Parameter	Value	Description	Default
41	p	Connection keyboard with SlimDoorPhone	0

p – connection SlimDoorPhone with keyboard,
p=0 disconnected, **p=1** connected

Rem: make a difference only in suppression and evaluate commands for SlimDoorPhone

Parameter	Value	Description	Default
42	o	Exit button control relay in SlimDoorPhone	0

o – select the relay, which has control from Exit button
o=0 control relay in keyboard, **o=1** control relay in SlimDoorPhone

Parameter	Value	Description	Default
43	bb	Time of hold Exit button	00

bb – min. time of hold necessary for exit button [2 místa 00-20]
step of the parameter is 0,5sec, its meaning, that
time in [sec] = Value of parameter / 2

for example. time of hold = **0 sec** enter value **bb=00**
time of hold = **1** enter value **bb=02**
time of hold = **5,5 sec** enter value **bb=11**

Parameter	Value	Description	Default
44	z	Exit button reacts to disconnection (switch off button)	0

z– way of evaluation press Exit button
z=0 switch on button (reacts to closure)
z=1 switch off button (reacts to open)

Parameter	Value	Description	Default
45	c	Time between button presses	2

c - maximal time between press buttons

If time between two next presses is bigger than **c** time, the code is not evaluated correctly.

Parameter	Value	Description	Default
46	a	Acoustic signalling	1

a - acoustic signalling (evaluation code, sending command to the SlimDoorPhone...) it is possible switch off

a=0 isn't acoustic signalling, **a=1** is acoustic signalling

Parameter	Value	Description	Default
47	l	Optical signalling	1

l - acoustic signalling (evaluation code, sending command to the SlimDoorPhone...) it is possible switch off

l=0 isn't acoustic signalling, **l=1** is acoustic signalling

5.4 Presetting and Deleting

Parameter	Value	Description	Default
51		Delete all access codes (par.1+2)	execute

This choice not change settings for relay and for basic parameters

Parameter	Value	Description	Default
52		Presetting default value (par.3+4)	execute

This choice not change settings access codes

Attention !!! make deletion is non - reversible !!!, then is necessary again programmed

5.1 Overview of Parameters

Parameter	Value	Description	Default
1	p hh...	Access code hh in sequence p for closure relay in keyboard	-
2	p hh...	Access code hh in sequence p for closure relay in SlimDoorPhone	-
31	m	Relay working in mode m	1
32	rr	Relay closing time rr [sec] - command evoked from keyboard	05
33	ss	Relay closing time ss [sec] - command evoked from Exit button	05
34	tt	Relay closing time tt [sec] - command evoked from SlimDoorPhone	05
35	vv	Time vv [sec] before closure relay - command evoked from SlimDoorPhone	0
36	dd	Time between 2 impulses [sec]	05
41	p	Connection keyboard with SlimDoorPhone	0
42	o	Exit button control relay in SlimDoorPhone	0
43	bb	Time of hold Exit button	00
44	z	Exit button reacts to disconnection (switch off button)	0
45	c	Time between button presses	2
46	a	Acoustic signalling	1
47	l	Optical signalling	1
51		Delete all access codes (par.1+2)	execute
52		Presetting default value (par.3+4)	execute

6 Technical parameters

6.1 Electrical parameters

Parameter	Value	Conditions
Power supply keyboard and heating	12VDC \pm 2V , 10-12VAC \pm 2V	
Max. consumption keyboard and heating	200mA	12VDC
Max. voltage of switch contact	48V	At I < 0,5A
Max. current of switch contact	1A	At U < 30 V
Exit button	Long to the 100m, switch on / switch off button	
Programování	PC (USB cable) / from keyboard	
Operational temperature	- 20 až + 50 st	

6.1 Mechanical dimensions

Dimensions WxHxD

104mm x 153mm x 16mm

Weight

360g

Unit material

elox aluminium profile

7 Vrtací šablona

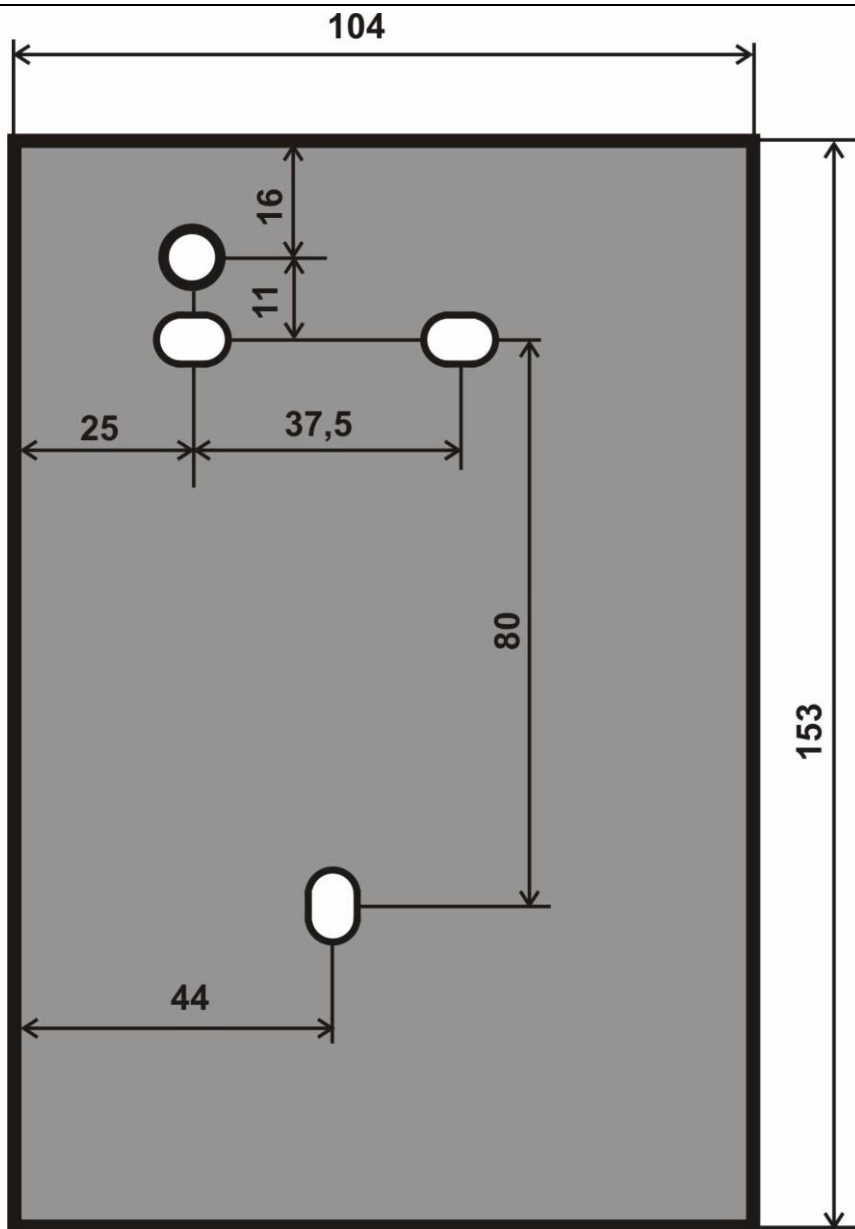



ALPHATECH TECHNOLOGIES s.r.o.
Jeremenkova 88, Praha 4, Czech Republic
www.alphatechtechnologies.cz

ALPHATECH TECHNOLOGIES s.r.o.

Jeremenkova 88
140 00 Praha 4
Czech Republic
VAT: CZ27577350

Company is registered in the Commercial Register
administered by the Municipal
Court in Prague, Section C, Record 116886

Banking details:

Komerční banka, account No. 43-7671450207/0100
IBAN: CZ0801000000437671450207
SWIFT: KOMBCZPPXXX

