

Konftel 55W Quick Reference Guide

The Konftel 55W is a conference unit that can be connected to your desktop phone, your mobile phone and your computer. It transforms your communication tools into conference phones using Konftel's unique audio technology, OmniSound® HD.

On / Off / Power save mode

Long press	On / off
Short press	Turns screen off

Mute (microphone off / speaker off)

Touch screen



LEDS

Flashing blue	Incoming call via Bluetooth
Steady blue light	Sound channel on / call in progress
Steady red light	Mute, microphone off
Flashing red	Hold, microphone and speaker turned off

DESCRIPTION

The Konftel 55W automatically detects the connections you make. When you connect a mobile phone, the screen displays a button for activating the audio stream from the mobile. When you insert an SD card, a button to record onto the card is displayed. A lit button indicates that the feature is active. When you press the button, it switches between on and off.

The Konftel 55W offers a range of connectivity options yet is very simple to use. Only the features that can be used at the time are displayed. If you wish to find out more about all the features of the Konftel 55W, please read the PDF manual on www.konftel.com.

Ports for expansion microphones Battery cover

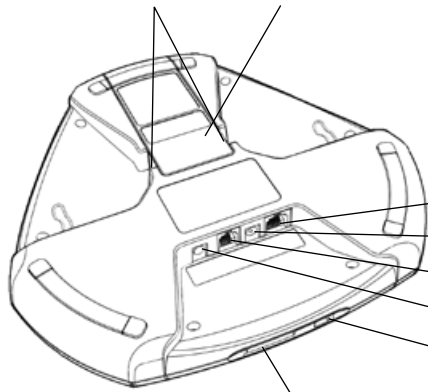

Connection for:

Desktop phone (adapter)

Power supply

Mobile phone

Headset (3.5 mm)

Computer (mini USB)

Port for SD memory card

It is possible to record a call in progress and use the Konftel 55W as a dictaphone.

Insert an SD card and press the record button to start recording.

Recordings can be accessed via the menu.

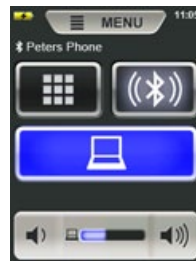

What the screen can look like.

Here a Bluetooth phone is connected and a computer is connected and active.

DESKTOP PHONE

Connection to a desktop phone

- ⇒ Connect the phone to the Konftel 55W using a phone adapter (accessory).

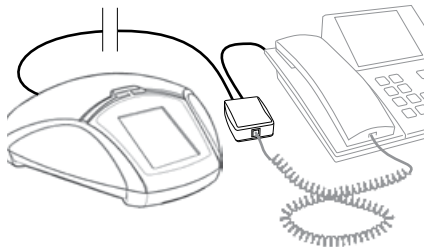

The  button is displayed on the Konftel 55W.



Unplug the telephone handset cable from the phone and connect it to the adapter as illustrated above.

- ⇒ Make a test call to check that the receiving party has a good sound level.
- ⓘ It is possible to adjust the Konftel 55W's microphone volume to achieve optimal performance with the phone being used. (See the user guide)

Making calls

- ⇒ Press  on the Konftel 55W to transfer the sound from the phone to the Konftel 55W.
The  button and the LEDs light up blue.
- ⇒ Lift the handset and make a call using the desktop phone.
- ⓘ Press the  button to move the sound to and from the desktop phone's handset.

MOBILE PHONE



Cable connection to a mobile phone

- ⇒ Connect the mobile phone to the Konftel 55W. (You will need an accessory cable for your phone.)

The  button is displayed on the Konftel 55W.

- ⇒ Make a test call to check that the receiving party has a good sound level.
- ⓘ It is possible to adjust the Konftel 55W's microphone volume to achieve optimal performance with the phone being used. (See the user guide)
- ⓘ Note that it is not possible to use a desktop phone and a mobile phone at the same time with the Konftel 55W. The desktop phone connection is disabled when the mobile phone is connected.

Making calls

- ⇒ Press the  button on the Konftel 55W to transfer the sound from the mobile to the Konftel 55W.
The  button and the LEDs light up blue.
- ⇒ Make a call using the mobile phone.
- ⓘ Press the  button to move the sound to and from the mobile phone.

Connection to a computer

- ⇒ Connect your computer to the Konftel 55W using the USB cable provided.





The  button is displayed on the Konftel 55W.

- ① Depending on the computer's operating system, you may need to change the setting so that the **Konftel 55W USB Audio** can be used as an audio unit.
- ① The Konftel 55W can be recharged and powered via USB provided the battery is inserted. It is not necessary to have the power adapter connected.

Using the Konftel with a computer

- ⇒ Press the  button on the Konftel 55W to activate the sound from the computer on the Konftel 55W.

The  button lights up blue and sound from the computer is heard from the Konftel 55W.

- ① Connect the call to the computer using, for example, web conference software or Skype®.
- ① Calls can be bridged via a connected phone (,  or ) and the computer  by pressing in both buttons on the Konftel 55W.

Connecting a phone with Bluetooth

Bluetooth has to be activated in the Konftel 55W and in your phone.





- ⇒ Press the  button on the Konftel 55W.
A list of already paired units is displayed.
- ⇒ Select your phone from the list and press ✓.

If your phone is not on the list, press **+** to add it. The mobile phone must be visible (Bluetooth setting).

When the phone is connected, the  button is displayed on the Konftel 55W. You will also see the name of your phone.

- ① If you have a call in progress on your phone, it will be automatically transferred to the Konftel 55W when the connection has been made.

Making calls

- ⇒ Make a call by pressing  and the number.
- ① The call can be transferred between the Konftel 55W and the mobile phone by pressing  and  respectively.
- ① It is also possible to make a call from the mobile phone and then press  to move the call to the Konftel 55W.

