

Panasonic®

Administrator Guide Cell Station Unit (SIP)



Model No. **KX-UDS124**

Thank you for purchasing this Panasonic product.
Please read this manual carefully before using this product and save this manual for future use.

KX-UDS124: Software File Version 01.300 or later

KX-UDS124 : DECT 6.0 Cell Station Unit (SIP)

KX-UDS124CE : DECT Cell Station Unit (SIP)

In this manual, the suffix of each model number (e.g., KX-UDS124**CE**) is omitted unless necessary.

Document Version: 2013-03

Introduction

Outline

This Administrator Guide provides detailed information on the configuration and management of this SIP Cell Station Unit (SIP-CS), which supports SIP-CS compatible Portable Stations (S-PSs).

Audience

This Administrator Guide contains explanations about the installation, maintenance, and management of the SIP-CS and is aimed at network administrators and dealers. Technical descriptions are included in this guide. Prior knowledge of networking and VoIP (Voice over Internet Protocol) is required.

Related Documentation

Installation Guide

Briefly describes basic information about the installation of the SIP-CS.

Manuals and supporting information are provided on the Panasonic Web site at:

<http://www.panasonic.com/sip> (for users in the United States)

<http://panasonic.net/pcc/support/sipphone> (for users in all other countries/areas)

Technical Support

When technical support is required, contact your dealer.

Open Source Software Notice

Parts of this product use open source software. For details about the open source software, see **11.1 Open Source Software**.

Trademarks

- Microsoft, Excel, Internet Explorer, Outlook, and Windows are either registered trademarks or trademarks of Microsoft Corporation in the United States and/or other countries.
- Mozilla and Firefox are registered trademarks of the Mozilla Foundation.
- Microsoft product screen shot(s) reprinted with permission from Microsoft Corporation.
- All other trademarks identified herein are the property of their respective owners.

NOTES

- The screen shots shown in this guide are provided for reference only, and may differ from the screens displayed on your PC.
- The contents and design of the software are subject to change without notice.

Terminology

Air Sync Group

Air Synchronization Group

To obtain steady air synchronization over a wide area, it is necessary to create Air Sync Groups.

Air Sync Master CS

Primary Clock Master of an Air Sync Group

Each Air Sync Group must have a unique Air Sync Master.

Air Sync Secondary Master CS

Secondary Clock Master of an Air Sync Group

DECT

Digital Enhanced Cordless Telecommunication

Handover

Allows you to move between CS coverage areas during a conversation without disrupting the call.

This is only possible within the same Air Sync Group.

IPEI

International Portable Equipment Identity

Decimal, 12-digit, globally unique identification code of PSs. Specified in ETSI EN 300 175-6.

Primary CS

Primary CS for air synchronization

Roaming

Allows you to move between coverage areas of SIP-CSs (even inter-Air Sync Group or inter-SIP Server) when the S-PS is idle.

S-PS

SIP-CS compatible Portable Station/Handset

Secondary CS

Secondary CS for air synchronization

SIP-CS

SIP Cell Station

Super Master CS

Master CS of Air Sync Group 1

This CS manages configuration for the whole system.

Tree Survey

The procedure to obtain a steady air synchronization tree.

Table of Contents

1	Overview	19
1.1	Overview of Programming	20
2	Web User Interface Programming	21
2.1	Web User Interface Programming	22
2.1.1	Before Accessing the Web User Interface	22
2.1.2	Accessing the Web User Interface	24
2.1.3	Web User Interface Setting List	25
2.2	Status	50
2.2.1	Version Information	50
2.2.1.1	CS Version Information	50
	Model	50
	Operating Bank	50
	IPL Version	51
	Firmware Version	51
2.2.1.2	PS Version Information (Model 1)	51
	Model	51
	Firmware Version	51
2.2.1.3	PS Version Information (Model 2)	51
	Model	51
	Firmware Version	51
2.2.1.4	PS Version Information (Model 3)	52
	Model	52
	Firmware Version	52
2.2.2	Network Status	52
2.2.2.1	Network Status	52
	MAC Address	52
	Ethernet Link Status (LAN Port)	53
	Connection Mode	53
	IP Address	53
	Subnet Mask	53
	Default Gateway	53
	DNS1	54
	DNS2	54
2.2.3	CS Version List	54
2.2.3.1	CS Version List	54
	Air Sync Group	54
	CS Name	55
	CS ID	55
	MAC Address	55
	Firmware Version	55
2.2.4	CS Information	55
2.2.4.1	CS Information	56
	Air Sync Group	56
	CS Name	56
	CS ID	56
	MAC Address	56
	Status	57
	Path 1–16	57
	Regist PS Number	58
2.2.5	PS Information	58
2.2.5.1	PS Information	58

	No.	58
	PS Name	58
	Model	59
	Firmware Version	59
	Phonebook Import Time [Result]	59
2.2.6	PS VoIP Status	59
2.2.6.1	PS VoIP Status	60
	No.	60
	PS Name	60
	Location CS Name	60
	Location CS MAC	60
	Phone Number	61
	VoIP Status	61
2.3	Network	61
2.3.1	Basic Network Settings	62
2.3.1.1	Connection Mode	62
	Connection Mode	62
2.3.1.2	DHCP Settings	63
	Host Name	63
	Domain Name Server	63
2.3.1.3	Static Settings	64
	Static IP Address	64
	Subnet Mask	64
	Default Gateway	64
	DNS1	64
	DNS2	65
2.3.1.4	Link Speed/Duplex Mode	65
	LAN Port	65
2.3.1.5	LLDP Settings	65
	Enable LLDP	65
	LLDP-MED Interval timer	65
	IP Phone (VLAN ID)	66
	IP Phone (Priority)	66
2.3.1.6	VLAN Settings	66
	Enable VLAN	66
	IP Phone (VLAN ID)	66
	IP Phone (Priority)	66
2.3.2	HTTP Client Settings	67
2.3.2.1	HTTP Client Settings	67
	HTTP Version	67
	HTTP User Agent	67
2.3.2.2	Proxy Server Settings	68
	Enable Proxy	68
	Proxy Server Address	68
	Proxy Server Port	68
2.3.3	HTTP Authentication	68
2.3.3.1	HTTP Authentication	69
	Authentication ID	69
	Authentication Password	69
2.3.4	Global Address Detection	69
2.3.4.1	Global Address Detection	70
	Detection Method	70
	Detection Interval	70
2.3.4.2	STUN Server	70
	STUN Server Address	70

Table of Contents

	STUN Server Port	71
2.4	System	71
2.4.1	Web Language	71
2.4.1.1	Web Language	71
	Language	71
2.4.2	Administrator Password	72
2.4.2.1	Change Administrator Password	72
	Current Password	72
	New Password	72
	Confirm New Password	72
2.4.3	Change User Password	73
2.4.3.1	Change User Password	73
	No.	73
	PS Name	73
	Phone Number	74
2.4.3.2	Changing User Password	74
2.4.3.3	PS Name	74
	PS Name	74
2.4.3.4	Change User Password	74
	New Password	74
	Confirm New Password	75
2.4.4	Web Server Settings	75
2.4.4.1	Web Server Settings	75
	Web Server Port	75
	Port Close Timer	76
2.4.5	Time Setting	76
2.4.5.1	Time Setting	76
	Date	76
	Time	76
2.4.6	Time Adjust Settings	77
2.4.6.1	Synchronization	77
	Enable Synchronization by NTP	77
	Synchronization Interval	77
2.4.6.2	Time Server	78
	NTP Server Address	78
2.4.6.3	Time Zone	78
	Time Zone	78
2.4.6.4	Daylight Saving Time (Summer Time)	78
	Enable DST (Enable Summer Time)	78
	DST Offset (Summer Time Offset)	78
2.4.6.5	Start Day and Time of DST (Start Day and Time of Summer Time)	78
	Month	78
	Day of Week	79
	Time	79
2.4.6.6	End Day and Time of DST (End Day and Time of Summer Time)	80
	Month	80
	Day of Week	80
	Time	81
2.4.7	CS Name	81
2.4.7.1	CS Name	81
	Name	81
2.4.8	Air Settings	81
2.4.8.1	Air Sync Group	82
	Air Sync Group	82
2.4.8.2	CS Class	82

	CS Class	82
2.4.8.3	Super Master CS IP Address	83
	IP Address	83
2.4.9	CS Management	83
2.4.9.1	CS Registration	84
	Air Sync Group	84
	Number of CS	84
2.4.9.2	CS Registered List	84
	No.	84
	Index	84
	CS Name	85
	CS ID	85
	MAC Address	85
	IP Address	85
	CS Class	85
2.4.10	Tree Survey	86
2.4.10.1	Tree Survey	86
	Air Sync Group	86
2.4.10.2	Survey List	87
	Index	87
	CS Name	87
	MAC Address	87
	CS Class	87
	Status	87
	Primary CS Index	88
	Secondary CS Index	88
	Level	88
2.4.11	CS Monitor	88
2.4.11.1	CS Monitor	89
	Air Sync Group	89
	Index	89
	RSSI	89
	Error Rate	90
	Wired LAN	90
	CS Name	90
	MAC Address	90
	Status	91
	Current Sync CS (CS Type)	91
	Current Sync CS (CS RPT)	91
	Current Sync CS (CS Index)	91
2.4.12	PS Registration	91
2.4.12.1	PS Registration	92
	No.	92
	PS Name	92
	Phone Number	92
	Wireless Status	93
2.4.13	PS Registration - Start PS Registration	93
2.4.14	PS Registration - Delete PS Registration	93
2.4.15	PS Registration - PS Settings	94
2.4.15.1	PIN Code	94
	PIN Code	94
2.5	VoIP	94
2.5.1	SIP Settings	95
2.5.1.1	SIP Setting	95
	SIP User Agent	95

Table of Contents

2.5.1.2	SIP Server	96
	Registrar Server Address	96
	Registrar Server Port	96
	Proxy Server Address	96
	Proxy Server Port	96
	Presence Server Address	97
	Presence Server Port	97
2.5.1.3	Outbound Proxy Server	97
	Outbound Proxy Server Address	97
	Outbound Proxy Server Port	97
2.5.1.4	SIP Service Domain	97
	Service Domain	97
2.5.1.5	DNS	98
	Enable DNS SRV lookup	98
	SRV lookup Prefix for UDP	98
	SRV lookup Prefix for TCP	98
2.5.1.6	Transport Protocol of SIP	98
	Transport Protocol	98
2.5.1.7	Timer Settings	99
	T1 Timer	99
	T2 Timer	99
	Timer B	99
	Timer D	99
	Timer F	100
	Timer H	100
	Timer J	100
2.5.1.8	Quality of Service (QoS)	100
	SIP Packet QoS (DSCP)	100
2.5.1.9	SIP extensions	100
	Supports 100rel (RFC 3262)	100
	Supports Session Timer (RFC 4028)	101
2.5.1.10	Security	101
	Enable SSAF (SIP Source Address Filter)	101
2.5.2	SIP Settings - PS	101
2.5.2.1	SIP Settings	102
	No.	102
	PS Name	102
	Line No.	102
	Phone Number	102
2.5.3	SIP Settings - PS [Line 1–2]	103
2.5.3.1	PS Name	103
	PS Name	103
2.5.3.2	Phone Number	103
	Phone Number	103
	SIP URI	104
2.5.3.3	SIP Authentication	104
	Authentication ID	104
	Authentication Password	104
2.5.3.4	SIP Source Port	104
	Source Port	104
2.5.4	VoIP Settings	105
2.5.4.1	RTP Settings	105
	RTP Packet Time	105
	Minimum RTP Port Number	106
	Maximum RTP Port Number	106

	Telephone-event Payload Type	106
2.5.4.2	Quality of Service (QoS)	107
	RTP Packet QoS (DSCP)	107
2.5.4.3	Statistical Information	107
	RTCP Enable	107
	RTCP Interval	107
2.5.4.4	Jitter Buffer	107
	Maximum Delay	107
	Minimum Delay	108
	Initial Delay	108
2.5.4.5	DTMF	108
	DTMF Type	108
2.5.4.6	Call Hold	108
	Supports RFC 2543 (c=0.0.0.0)	108
2.5.4.7	CODEC Preferences	109
	G722 (Enable)	109
	G722 (Priority)	109
	PCMA (Enable)	109
	PCMA (Priority)	109
	G726-32 (Enable)	110
	G726-32 (Priority)	110
	G729A (Enable)	110
	G729A (Priority)	110
	PCMU (Enable)	110
	PCMU (Priority)	110
2.6	Telephone	111
2.6.1	Call Control - Common	111
2.6.1.1	Call Control	112
	Send SUBSCRIBE to Voice Mail Server	112
	Conference Server URI	112
	Inter-digit Timeout	112
	Timer for Dial Plan	112
	International Call Prefix	113
	Country Calling Code	113
	National Access Code	113
	Flash/Recall Button	113
	Flash Hook Event	113
2.6.1.2	Call Rejection Phone Numbers	114
	1-30	114
2.6.2	Call Control - PS	114
2.6.2.1	Call Control	114
	No.	114
	PS Name	115
	Line No. 1-2	115
	Phone Number	115
2.6.3	Call Control [PS]	115
2.6.3.1	PS Name	116
	PS Name	116
2.6.3.2	Call Control	116
	Default Line for Outgoing	116
2.6.3.3	Dial Plan	116
	Dial Plan (max 500 columns)	116
	Call Even If Dial Plan Does Not Match	116
2.6.4	Call Control [Line 1-2]	117
2.6.4.1	PS Name	117

Table of Contents

	PS Name	117
2.6.4.2	Phone Number	118
	Phone Number	118
2.6.4.3	Call Control	118
	Display Name	118
	Voice Mail Access Number	118
	Enable Shared Call	118
	Synchronize Do Not Disturb and Call Forward	119
2.6.4.4	Call Features	119
	Block Caller ID	119
	Block Anonymous Call	119
	Do Not Disturb	120
2.6.4.5	Call Forward	120
	Unconditional (Enable Call Forward)	120
	Unconditional (Phone Number)	121
	Busy (Enable Call Forward)	121
	Busy (Phone Number)	122
	No Answer (Enable Call Forward)	122
	No Answer (Phone Number)	123
	No Answer (Ring Count)	123
2.6.5	Button Settings	123
2.6.5.1	Button Settings	124
	No.	124
	PS Name	124
	Phone Number	124
2.6.6	Button Settings - PS	125
2.6.6.1	PS Name	125
	PS Name	125
2.6.6.2	Flexible Button Settings	125
	No.	125
	Type (No. 1–12)	126
	Parameter (No. 1–12)	126
	Label Name (No. 1–12)	126
2.6.7	Button Settings - Copy & Paste	127
2.6.7.1	Copy Source PS Name	127
	PS Name	127
2.6.7.2	Copy Source Flexible Button Settings	127
	No.	127
	Type (No. 1–12)	128
	Parameter (No. 1–12)	128
	Label Name (No. 1–12)	128
2.6.7.3	Copy Destination PS Lists	128
2.6.8	Tone Settings	129
2.6.8.1	Dial Tone	129
	Tone Frequencies	129
	Tone Timings	130
2.6.8.2	Busy Tone	130
	Tone Frequencies	130
	Tone Timings	130
2.6.8.3	Ringing Tone	131
	Tone Frequencies	131
	Tone Timings	131
2.6.8.4	Stutter Tone	131
	Tone Frequencies	131
	Tone Timings	131

2.6.8.5	Reorder Tone	132
	Tone Frequencies	132
	Tone Timings	132
2.6.9	Telephone Settings	132
2.6.9.1	Telephone Settings	132
	Number Matching Lower Digit	132
	Number Matching Upper Digit	133
2.6.10	Import Phonebook - All	133
2.6.10.1	Import Mode	133
	Mode Select	133
2.6.10.2	Import Time Setting	134
	Date	134
	Time	134
2.6.10.3	Import Phonebook	134
	File Name	134
2.6.11	Import Phonebook - PS	134
2.6.11.1	Import Phonebook	135
	No.	135
	PS Name	135
	Phone Number	135
2.6.12	Import Phonebook (PS select screen)	136
2.6.12.1	PS Name	136
	PS Name	136
2.6.12.2	Import Phonebook	136
	File Name	136
2.6.13	Export Phonebook - PS	136
2.6.13.1	Export Phonebook	137
	PS Name	137
	Phone Number	137
2.7	Maintenance	137
2.7.1	Backup	138
2.7.2	Restore	138
2.7.3	Firmware Maintenance	139
2.7.3.1	Firmware Maintenance	139
	Enable Firmware Update	139
	Firmware File URL	139
	PS Update Type	140
2.7.4	All Firmware Update	140
2.7.4.1	Update Mode	141
	Mode	141
2.7.4.2	Update Time Setting	141
	Date	141
	Time	141
2.7.4.3	Update Firmware	141
	Encryption	141
	File Name	141
2.7.5	Provisioning Maintenance	142
2.7.5.1	Provisioning Maintenance	143
	Enable Provisioning	143
	Standard File URL	143
	Product File URL	143
	Master File URL	143
	System File URL	144
	Cyclic Auto Resync	144
	Resync Interval	144

	Header Value for Resync Event	144
2.7.6	Error Log	145
2.7.7	Restart	145
3	General Information on Provisioning	147
3.1	Pre-provisioning	148
3.1.1	What is Pre-provisioning?	148
3.1.2	Pre-provisioning when Setting Static IP Addresses	148
3.1.3	Server for Pre-provisioning	149
3.1.4	Pre-provisioning Setting Example	149
3.2	Provisioning	152
3.2.1	What is Provisioning?	152
3.2.2	Protocols for Provisioning	152
3.2.3	Configuration File	152
3.2.4	Downloading Configuration Files	154
3.2.5	Provisioning Server Setting Example	157
3.2.6	Encryption	158
3.3	Priority of Setting Methods	159
3.4	Configuration File Specifications	160
3.5	Configuration File Examples	161
3.5.1	Examples of Codec Settings	161
3.5.2	Example with Incorrect Descriptions	162
4	Configuration File Programming	165
4.1	General Information on the Configuration Files	166
4.1.1	Configuration File Parameters	166
4.1.2	Characters Available for String Values	167
4.2	System Settings	167
4.2.1	Login Account Settings	167
	ADMIN_ID	167
	ADMIN_PASS	167
	USER_PASS_PSy	168
4.2.2	System Time Settings	168
	TIME_ZONE	168
	DST_ENABLE	168
	DST_OFFSET	169
	DST_START_MONTH	169
	DST_START_ORDINAL_DAY	169
	DST_START_DAY_OF_WEEK	170
	DST_START_TIME	170
	DST_STOP_MONTH	171
	DST_STOP_ORDINAL_DAY	171
	DST_STOP_DAY_OF_WEEK	171
	DST_STOP_TIME	172
	LOCAL_TIME_ZONE_POSIX	172
4.2.3	Syslog Settings	173
	SYSLOG_EVENT_SIP	173
	SYSLOG_EVENT_CFG	173
	SYSLOG_EVENT_VOIP	173
	SYSLOG_EVENT_TEL	173
	SYSLOG_ADDR	174
	SYSLOG_PORT	174
	SYSLOG_RTPSMPLY_INTVL	174
4.2.4	Firmware Update Settings	174
	FIRM_UPGRADE_ENABLE	174

	FIRM_VERSION	175
	PS_FIRM_UPGRADE_AUTO	175
	FIRM_FILE_PATH	175
4.2.5	Provisioning Settings	176
	OPTION66_ENABLE	176
	OPTION66_REBOOT	176
	PROVISION_ENABLE	177
	CFG_STANDARD_FILE_PATH	177
	CFG_PRODUCT_FILE_PATH	178
	CFG_MASTER_FILE_PATH	179
	CFG_SYSTEM_FILE_PATH	180
	CFG_FILE_KEY1	181
	CFG_FILE_KEY2	182
	CFG_FILE_KEY3	182
	CFG_FILE_KEY4	182
	CFG_FILE_KEY_LENGTH	183
	CFG_CYCLIC	183
	CFG_CYCLIC_INTVL	183
	CFG_RTRY_INTVL	183
	CFG_RESYNC_TIME	184
	CFG_RESYNC_FROM_SIP	184
4.2.6	Other Settings	184
	IPEI_PSy	184
	SIP_REGI_PS_LIMIT	184
	PROVISION_SUPERMASTER_ONLY	185
	PS_FIRM_UPGRADE_MODE	185
4.3	Network Settings	186
4.3.1	IP Settings	186
	CONNECTION_TYPE	186
	HOST_NAME	186
	DHCP_DNS_ENABLE	186
	STATIC_IP_ADDRESS	187
	STATIC_SUBNET	187
	STATIC_GATEWAY	187
	USER_DNS1_ADDR	188
	USER_DNS2_ADDR	188
4.3.2	DNS Settings	188
	DNS_QRY_PRL	188
	DNS_PRIORITY	189
	DNS1_ADDR	189
	DNS2_ADDR	189
4.3.3	Ethernet Port Settings	189
	LLDP_ENABLE	189
	LLDP_INTERVAL	190
	VLAN_ENABLE	190
	VLAN_ID_IP_PHONE	190
	VLAN_PRI_IP_PHONE	190
4.3.4	HTTP Settings	190
	HTTPD_PORTOPEN_AUTO	190
	HTTP_VER	191
	HTTP_USER_AGENT	191
	HTTP_SSL_VERIFY	192
	CFG_ROOT_CERTIFICATE_PATH	192
4.3.5	Time Adjust Settings	193
	NTP_ADDR	193

Table of Contents

	TIME_SYNC_INTVL	193
	TIME_QUERY_INTVL	193
4.3.6	STUN Settings	193
	STUN_SERV_ADDR	193
	STUN_SERV_PORT	193
	STUN_2NDSERV_ADDR	194
	STUN_2NDSERV_PORT	194
4.4	Telephone Settings	194
4.4.1	Call Control Settings	194
	VM_SUBSCRIBE_ENABLE	194
	CONFERENCE_SERVER_URI	194
	FIRSTDIGIT_TIM	195
	INTDIGIT_TIM	195
	MACRODIGIT_TIM	195
	INTERNATIONAL_ACCESS_CODE	196
	COUNTRY_CALLING_CODE	196
	NATIONAL_ACCESS_CODE	196
	DEFAULT_LINE_SELECT_PSy	196
	HOLD_RECALL_TIM	196
	AUTO_CALL_HOLD	197
	DISCONNECTION_MODE	197
	TONE_LEN_DISCONNECT_HANDSFREE	197
4.4.2	Tone Settings	197
	DIAL_TONE1_FRQ	197
	DIAL_TONE1_GAIN	198
	DIAL_TONE1_RPT	198
	DIAL_TONE1_TIMING	198
	DIAL_TONE2_FRQ	198
	DIAL_TONE2_GAIN	199
	DIAL_TONE2_RPT	199
	DIAL_TONE2_TIMING	199
	DIAL_TONE4_FRQ	199
	DIAL_TONE4_GAIN	200
	DIAL_TONE4_RPT	200
	DIAL_TONE4_TIMING	200
	BUSY_TONE_FRQ	200
	BUSY_TONE_GAIN	201
	BUSY_TONE_RPT	201
	BUSY_TONE_TIMING	201
	REORDER_TONE_FRQ	201
	REORDER_TONE_GAIN	201
	REORDER_TONE_RPT	202
	REORDER_TONE_TIMING	202
	RINGBACK_TONE_FRQ	202
	RINGBACK_TONE_GAIN	202
	RINGBACK_TONE_RPT	203
	RINGBACK_TONE_TIMING	203
	HOLD_TONE_FRQ	203
	HOLD_TONE_GAIN	203
	BELL_CORE_PATTERN1_TIMING	204
	BELL_CORE_PATTERN2_TIMING	204
	BELL_CORE_PATTERN3_TIMING	204
	BELL_CORE_PATTERN4_TIMING	204
	BELL_CORE_PATTERN5_TIMING	205
4.4.3	Telephone Settings	205

	NUMBER_MATCHING_LOWER_DIGIT	205
	NUMBER_MATCHING_UPPER_DIGIT	205
	DEFAULT_LANGUAGE	206
	POUND_KEY_DELIMITER_ENABLE	206
	FLEXIBLE_KEY_LIST_DISPLAY_TIMER	206
4.4.4	SIP-CS Settings	207
	WL_PSREGISTRATION_PIN	207
	WL_AIRSYNCGROUP_CS	207
	SUPERMASTER_IPADDRESS_CS	207
	WL_CLASS_CS	207
	HO_RTP_PORT_MIN	208
	HO_RTP_PORT_MAX	208
	HO_EXE_TIME	208
4.4.5	Flexible Button Settings	209
	FLEX_BUTTON_FACILITY_ACTx_PSy	209
	FLEX_BUTTON_FACILITY_ARGx_PSy	209
	FLEX_BUTTON_QUICK_DIALx_PSy	209
	FLEX_BUTTON_LABELx_PSy	210
4.5	VoIP Settings	210
4.5.1	Codec Settings	210
	CODEC_G711_REQ	210
	CODEC_G729_PARAM	210
	CODEC_ENABLEx	210
	CODEC_PRIORITYx	211
4.5.2	RTP Settings	211
	DSCP_RTP	211
	DSCP_RTCP	212
	RTCP_INTVL	212
	MAX_DELAY	212
	MIN_DELAY	212
	NOM_DELAY	213
	RTP_PORT_MIN	213
	RTP_PORT_MAX	213
	RTP_PTIME	214
	RTCP_ENABLE	214
	RTCP_SEND_BY_SDP	214
	RTP_CLOSE_ENABLE	214
4.5.3	Miscellaneous VoIP Settings	215
	OUTBANDDTMF	215
	DTMF_RELAY	215
	OUTBANDDTMF_VOL	215
	INBANDDTMF_VOL	215
	TELEVENT_PAYLOAD	216
	RFC2543_HOLD_ENABLE	216
	DTMF_SIGNAL_LEN	216
	DTMF_INTDIGIT_TIM	216
4.6	Line Settings	217
4.6.1	Call Control Settings	217
	DISPLAY_NAME_PSy_n	217
	VM_NUMBER_PSy_n	217
	DIAL_PLAN_PSy	217
	DIAL_PLAN_NOT_MATCH_ENABLE_PSy	218
	SHARED_CALL_ENABLE_PSy_n	218
	FWD_DND_SYNCHRO_ENABLE_PSy_n	219
	CW_ENABLE_PSy_n	219

	RETURN_VOL_SET_DEFAULT_ENABLE	219
	FLASH_RECALL_TERMINATE	220
	FLASHHOOK_CONTENT_TYPE	220
	VOICE_MESSAGE_AVAILABLE	220
	HOLD_SOUND_PATH	220
4.6.2	SIP Settings	221
	SIP_USER_AGENT	221
	PHONE_NUMBER_PSy_n	221
	SIP_URI_PSy_n	222
	LINE_ENABLE_PSy_n	222
	PROFILE_ENABLE_PSy	223
	PROFILE_NAME_CS	
	PROFILE_NAME_PSy	223
	SIP_AUTHID_PSy_n	223
	SIP_PASS_PSy_n	223
	SIP_SRC_PORT_PSy_n	224
	SIP_PRXY_ADDR	224
	SIP_PRXY_PORT	224
	SIP_RGSTR_ADDR	225
	SIP_RGSTR_PORT	225
	SIP_SVCDOMAIN	225
	REG_EXPIRE_TIME	225
	REG_INTERVAL_RATE	225
	SIP_SESSION_TIME	226
	SIP_SESSION_METHOD	226
	DSCP_SIP	226
	SIP_2NDPROXY_ADDR	226
	SIP_2NDPROXY_PORT	226
	SIP_2NDRGSTR_ADDR	227
	SIP_2NDRGSTR_PORT	227
	SIP_TIMER_T1	227
	SIP_TIMER_T2	227
	SIP_TIMER_T4	228
	SIP_FOVR_NORSP	228
	SIP_FOVR_MAX	228
	SIP_REFRESHER	229
	SIP_DNSSRV_ENA	229
	SIP_UDP_SRV_PREFIX	229
	SIP_TCP_SRV_PREFIX	229
	SIP_100REL_ENABLE	230
	SIP_INVITE_EXPIRE	230
	SIP_18X_RTX_INTVL	230
	SIP_PR SNC_ADDR	231
	SIP_PR SNC_PORT	231
	SIP_2NDPR SNC_ADDR	231
	SIP_2NDPR SNC_PORT	231
	USE_DEL_REG_OPEN	231
	PORT_PUNCH_INTVL	232
	SIP_ADD_RPORT	232
	SIP_REQURI_PORT	232
	SIP_SUBS_EXPIRE	233
	SUB_RTX_INTVL	233
	REG_RTX_INTVL	233
	SIP_P_PREFERRED_ID	233
	SIP_PRIVACY	234

ADD_USER_PHONE	234
SDP_USER_ID	234
SUB_INTERVAL_RATE	234
SIP_OUTPROXY_ADDR	235
SIP_OUTPROXY_PORT	235
SIP_TRANSPORT	235
SIP_ANM_DISPNAME	235
SIP_ANM_USERNAME	235
SIP_ANM_HOSTNAME	236
SIP_DETECT_SSAF	236
SIP_RCV_DET_HEADER	236
SIP_CONTACT_ON_ACK	237
SIP_TIMER_B	237
SIP_TIMER_D	237
SIP_TIMER_F	237
SIP_TIMER_H	238
SIP_TIMER_J	238
ADD_TRANSPORT_UDP	238
ADD_EXPIRES_HEADER	238
SIP_HOLD_HOLDRECEIVE	238
SIP_ADD_DIVERSION	239
SIP_RESPONSE_CODE_DND	239
SIP_RESPONSE_CODE_CALL_REJECT	239
SIP_FOVR_MODE	239
SIP_FOVR_DURATION	240
SIP_403_REG_SUB_RTX	240
CSL_PC_LISTEN_PORT	240
5 PS Registration	241
5.1 PS Registration from Web User Interface	242
5.2 PS Registration using Provisioning	248
6 Useful Telephone Functions	251
6.1 Phonebook Import and Export	252
6.1.1 Import/Export Operation	254
6.1.2 Editing with Microsoft Excel	255
6.1.3 Exporting Data from Microsoft Outlook	258
6.2 Dial Plan	258
6.2.1 Dial Plan Settings	259
6.3 Flexible Buttons	262
6.3.1 Flexible Button Settings	262
6.4 Copying Flexible Button Settings to Other S-PSs	263
7 Firmware Update	265
7.1 Firmware Update Overview	266
7.2 Firmware Server Setup	267
7.3 Firmware Update Settings	267
7.4 Executing Firmware Update	268
7.5 Local Firmware Update	269
8 How to Backup and Restore Configurations	271
8.1 How to back up and restore configuration data	272
9 Resetting to Factory Default	275
9.1 Resetting to Factory Default	276

10 Troubleshooting	277
10.1 Troubleshooting	278
11 Appendix	281
11.1 Open Source Software	282
Index	287

Section 1

Overview

This section provides an overview of the programming of the SIP-CS.

1.1 Overview of Programming

There are 2 types of programming, as shown in the table below:

Programming Type	Description	References
Web user interface programming	Configuring the SIP-CSs settings by accessing the Web user interface from a PC connected to the same network.	→ Section 2 Web User Interface Programming
Configuration file programming	Configuring the SIP-CSs settings beforehand by creating configuration files (pre-provisioning), and having the SIP-CS download the files from a server on the Internet and configure its own settings (provisioning).	→ Section 3 General Information on Provisioning → Section 4 Configuration File Programming

All programming is controlled by the Super Master CS. When programming is performed on the Super Master CS, all necessary configuration data is distributed to all other Air Sync Master CSs and Slave CSs. For details about the different types of SIP-CSs, refer to the Installation Guide on the Panasonic Web site (→ see **Introduction**).

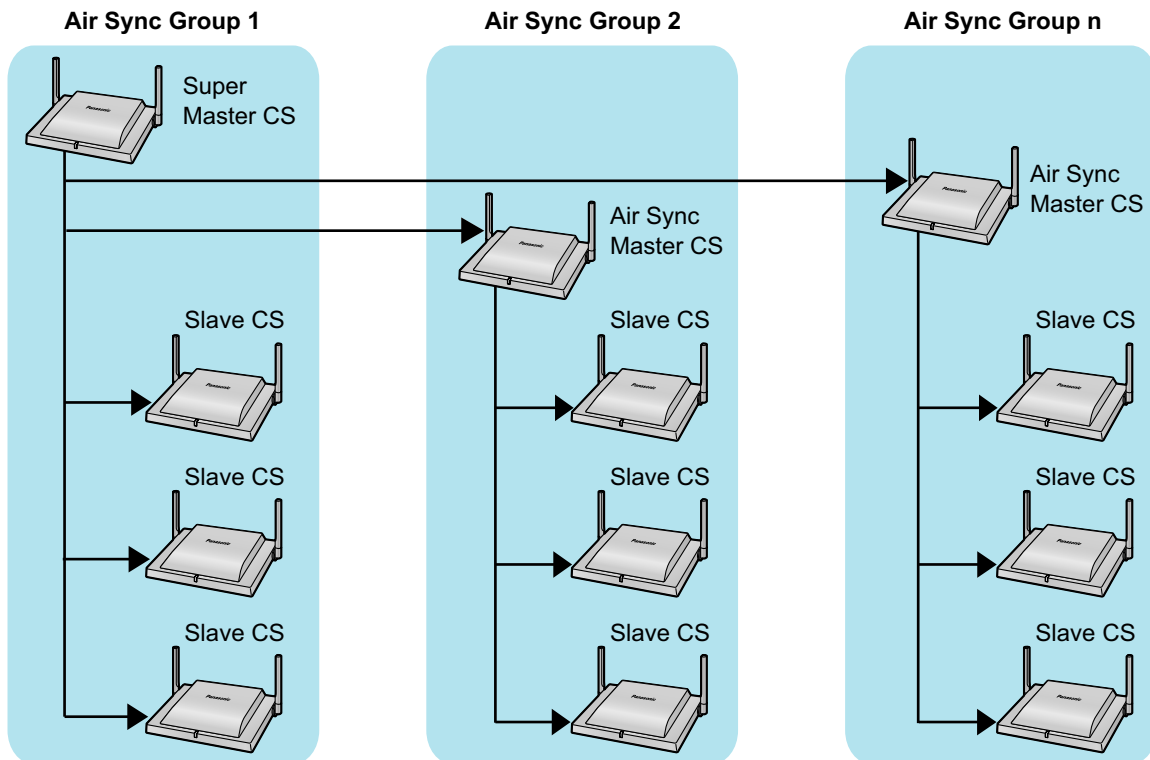

Section 2

Web User Interface Programming

This section provides information about the settings available in the Web user interface.

2.1 Web User Interface Programming

After connecting the SIP-CS (Super Master CS) to your network, you can configure the SIP-CS's settings by accessing the Web user interface from a PC connected to the same network.

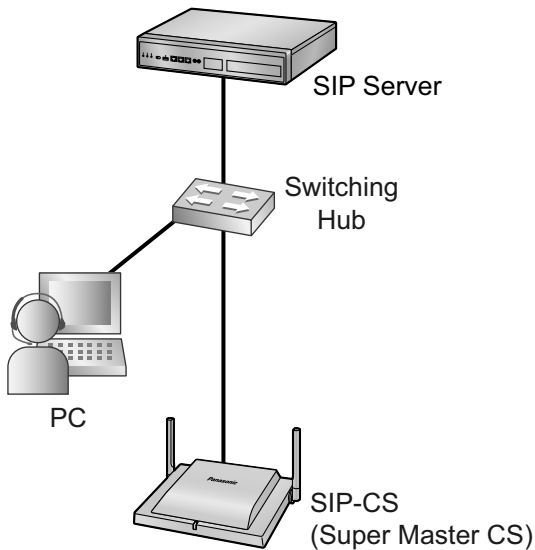

2.1.1 Before Accessing the Web User Interface

Account Login ID and Password

Access to the Web user interface requires the following login ID and password:

Account	ID (default)	Password (default)	Password Restrictions
Administrator	admin	adminpass	<ul style="list-style-type: none">You can change the password (→ see 2.4.2 Administrator Password).The password can consist of 6 to 16 ASCII characters (case-sensitive).

Notice

- You cannot log in to the Web user interface using the same account as someone who is already logged in.
- The ID can be changed through configuration file programming (→ see "ADMIN_ID" in **4.2.1 Login Account Settings**).
- You can reset the account ID and password to their factory default settings by pressing the RESET switch on the back of the SIP-CS. For details, see **9.1 Resetting to Factory Default**.

Recommended Environment

This SIP-CS supports the following specifications:

HTTP Version	HTTP/1.0 (RFC 1945), HTTP/1.1 (RFC 2616)
Authentication Method	Digest (or Basic)

The Web user interface will operate correctly in the following environments:

Operating System	Microsoft® Windows® XP or Windows 7 operating system (32 bit)
Web Browser	Windows Internet Explorer® 7, Windows Internet Explorer 8, Windows Internet Explorer 9, or Mozilla® Firefox® web browser
Language (recommended)	English

Opening the Web Port

To access the Web user interface, you must open the SIP-CS's Web port beforehand.

Note

- If there are no registered S-PSs, the SIP-CS's Web port is always open.
- Turn on the S-PS.
 - Press  / **MENU** or the **[CENTER]** navigation key.

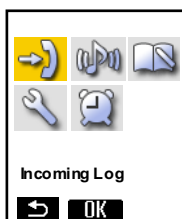

- Select  ("Setting Handset") and then press **OK**.

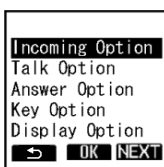

- Press **NEXT**.

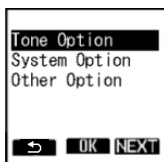

- Select "System Option" and then press **OK**.
The "System Option" menu is displayed.

2.1.2 Accessing the Web User Interface

Note

- You may need to enter a system password to access this menu.

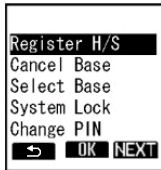

- Press **NEXT** to display the second screen, select "Enable CS Web", and then press **OK**.
- When the operation is complete, the following screen is displayed.



Note

- You can access the Web with a fixed IP address without a registered S-PS by following the procedure below.
 - Turn on SIP-CS by holding the RESET switch.
 - After the LED flashes red, amber and green alternately, release the RESET switch. The default IP address and subnet mask are as follows:
 - IP address: 192.168.0.241
 - Subnet mask: 255.255.255.0
- When accessing the Web with a fixed IP address, the VLAN feature will be turned off.

2.1.2 Accessing the Web User Interface

The SIP-CS can be configured from the Web user interface.

To access the Web user interface

- Determine the Master CS's IP address.

If the Master CS's IP address is already known, skip this step and proceed to step 2.

 - Enter the "Setting Handset" menu on your S-PS (→ see **Opening the Web Port**).
 - Select "Other Option" and then press **OK**.

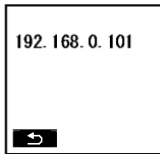

- Select "MasterCS Address" and then press **OK**.

[Example]

2. Open your Web browser, and then enter "http://" followed by the SIP-CS's IP address into the address field of your browser.
3. Log in to the SIP-CS as the administrator.

Note

- The default ID and password for the administrator are as follows:
 - ID: admin
 - Password: adminpass
4. The Web user interface window is displayed. Configure the settings for the SIP-CS as desired.
 5. You can log out from the Web user interface at any time by clicking **[Web Port Close]**.

2.1.3 Web User Interface Setting List

The following tables show all the settings that you can configure from the Web user interface. For details about each setting, see the reference pages listed.

IMPORTANT

Please note that all screens are available when accessing the Web user interface for a Super Master CS. However, some screens are not available when accessing the Web user interface for an Air Sync Master CS or a Slave CS.

Status

Version Information

Web User Interface			Configuration File Parameter	
Section Title	Setting	Ref. (Page)	Parameter Name	Ref. (Page)
CS Version Information	Model	50	—	—
	Operating Bank	50	—	—
	IPL Version	51	—	—
	Firmware Version	51	—	—
PS Version Information (Model 1)	Model	51	—	—
	Firmware Version	51	—	—
PS Version Information (Model 2)	Model	51	—	—
	Firmware Version	51	—	—
PS Version Information (Model 3)	Model	52	—	—
	Firmware Version	52	—	—

2.1.3 Web User Interface Setting List

Network Status

Web User Interface			Configuration File Parameter	
Section Title	Setting	Ref. (Page)	Parameter Name	Ref. (Page)
Network Status	MAC Address	52	—	—
	Ethernet Link Status (LAN Port)	53	—	—
	Connection Mode	53	—	—
	IP Address	53	—	—
	Subnet Mask	53	—	—
	Default Gateway	53	—	—
	DNS1	54	—	—
	DNS2	54	—	—

CS Version List

Web User Interface			Configuration File Parameter	
Section Title	Setting	Ref. (Page)	Parameter Name	Ref. (Page)
CS Version List	Air Sync Group	54	—	—
	CS Name	55	—	—
	CS ID	55	—	—
	MAC Address	55	—	—
	Firmware Version	55	—	—

CS Information

Web User Interface			Configuration File Parameter	
Section Title	Setting	Ref. (Page)	Parameter Name	Ref. (Page)
CS Information	Air Sync Group	56	—	—
	CS Name	56	—	—
	CS ID	56	—	—
	MAC Address	56	—	—
	Status	57	—	—
	Path 1–16	57	—	—
	Regist PS Number	58	—	—

PS Information

Web User Interface			Configuration File Parameter	
Section Title	Setting	Ref. (Page)	Parameter Name	Ref. (Page)
PS tab screen			—	—
PS Information	No.	58	—	—
	PS Name	58	PROFILE_NAME_PSy	223
	Model	59	—	—
	Firmware Version	59	—	—
	Phonebook Import Time [Result]	59	—	—

PS VoIP Status

Web User Interface			Configuration File Parameter	
Section Title	Setting	Ref. (Page)	Parameter Name	Ref. (Page)
PS tab screen			—	—
PS VoIP Status	No.	60	—	—
	PS Name	60	PROFILE_NAME_PSy	223
	Location CS Name	60	—	—
	Location CS MAC	60	—	—
	Phone Number	61	PHONE_NUMBER_PSy_n	221
	VoIP Status	61	—	—

Network**Basic Network Settings**

Web User Interface			Configuration File Parameter	
Section Title	Setting	Ref. (Page)	Parameter Name	Ref. (Page)
Connection Mode	Connection Mode	62	CONNECTION_TYPE	186
DHCP Settings	Host Name	63	HOST_NAME	186
	Domain Name Server	63	DHCP_DNS_ENABLE	186
			DNS1_ADDR	189
			DNS2_ADDR	189

2.1.3 Web User Interface Setting List

Web User Interface			Configuration File Parameter	
Section Title	Setting	Ref. (Page)	Parameter Name	Ref. (Page)
Static Settings	Static IP Address	64	STATIC_IP_ADDRESS	187
	Subnet Mask	64	STATIC_SUBNET	187
	Default Gateway	64	STATIC_GATEWAY	187
	DNS1	64	USER_DNS1_ADDR	188
	DNS2	65	USER_DNS2_ADDR	188
Link Speed/Duplex Mode	LAN Port	65	—	—
LLDP Settings	Enable LLDP	65	LLDP_ENABLE	189
	LLDP-MED Interval timer	65	LLDP_INTERVAL	190
	IP Phone	—	—	—
	VLAN ID	—	—	—
	Priority	—	—	—
VLAN Settings	Enable VLAN	66	VLAN_ENABLE	189
	IP Phone	—	—	—
	VLAN ID	66	VLAN_ID_IP_PHONE	190
	Priority	66	VLAN_PRI_IP_PHONE	190

HTTP Client Settings

Web User Interface			Configuration File Parameter	
Section Title	Setting	Ref. (Page)	Parameter Name	Ref. (Page)
HTTP Client Settings	HTTP Version	67	HTTP_VER	191
	HTTP User Agent	67	HTTP_USER_AGENT	191
Proxy Server Settings	Enable Proxy	68	—	—
	Proxy Server Address	68	—	—
	Proxy Server Port	68	—	—

HTTP Authentication

Web User Interface			Configuration File Parameter	
Section Title	Setting	Ref. (Page)	Parameter Name	Ref. (Page)
HTTP Authentication	Authentication ID	69	—	—
	Authentication Password	69	—	—

Global Address Detection

Web User Interface			Configuration File Parameter	
Section Title	Setting	Ref. (Page)	Parameter Name	Ref. (Page)
Global Address Detection	Detection Method	70	—	—
	Detection Interval	70	—	—
STUN Server	STUN Server Address	70	STUN_SERV_ADDR	193
	STUN Server Port	71	STUN_SERV_PORT	193

System

Web Language

Web User Interface			Configuration File Parameter	
Section Title	Setting	Ref. (Page)	Parameter Name	Ref. (Page)
Web Language	Language	71	—	—

Administrator Password

Web User Interface			Configuration File Parameter	
Section Title	Setting	Ref. (Page)	Parameter Name	Ref. (Page)
Change Administrator Password	Current Password	72	ADMIN_PASS	167
	New Password	72	ADMIN_PASS	167
	Confirm New Password	72	ADMIN_PASS	167

Change User Password

Web User Interface			Configuration File Parameter	
Section Title	Setting	Ref. (Page)	Parameter Name	Ref. (Page)
PS tab screen		—	—	—
Change User Password	No.	73	—	—
	PS Name	73	PROFILE_NAME_PSy	223
	Phone Number	74	PHONE_NUMBER_PSy_n	221
PS select screen		—	—	—
PS Name	PS Name	74	PROFILE_NAME_PSy	223
Change User Password	New Password	74	USER_PASS_PSy	168
	Confirm New Password	75	USER_PASS_PSy	168

2.1.3 Web User Interface Setting List

Web Server Settings

Web User Interface			Configuration File Parameter	
Section Title	Setting	Ref. (Page)	Parameter Name	Ref. (Page)
Web Server Settings	Web Server Port	75	—	—
	Port Close Timer	76	—	—

Time Setting

Web User Interface			Configuration File Parameter	
Section Title	Setting	Ref. (Page)	Parameter Name	Ref. (Page)
Time Setting	Date	—	—	—
	Date	76	—	—
	Month	76	—	—
	Year	76	—	—
	Time	—	—	—
	Hour	76	—	—
	Minute	76	—	—

Time Adjust Settings

Web User Interface			Configuration File Parameter	
Section Title	Setting	Ref. (Page)	Parameter Name	Ref. (Page)
Synchronization	Enable Synchronization by NTP	77	—	—
	Synchronization Interval	77	TIME_QUERY_INTVL	193
Time Server	NTP Server Address	78	NTP_ADDR	193
Time Zone	Time Zone	78	TIME_ZONE	168
Daylight Saving Time (Summer Time)	Enable DST (Enable Summer Time)	78	DST_ENABLE	168
	DST Offset (Summer Time Offset)	78	DST_OFFSET	169
Start Day and Time of DST (Start Day and Time of Summer Time)	Month	78	DST_START_MONTH	169
	Day of Week	79	DST_START_ORDINAL_DAY DST_START_DAY_OF_WEEK	169, 170
	Time	79	DST_START_TIME	170

Web User Interface			Configuration File Parameter	
Section Title	Setting	Ref. (Page)	Parameter Name	Ref. (Page)
End Day and Time of DST (End Day and Time of Summer Time)	Month	80	DST_STOP_MONTH	171
	Day of Week	80	DST_STOP_ORDINAL_D AY DST_STOP_DAY_OF_WE EK	171, 171
	Time	81	DST_STOP_TIME	172

CS Name

Web User Interface			Configuration File Parameter	
Section Title	Setting	Ref. (Page)	Parameter Name	Ref. (Page)
CS Name	Name	81	PROFILE_NAME_CS	223

Air Settings

Web User Interface			Configuration File Parameter	
Section Title	Setting	Ref. (Page)	Parameter Name	Ref. (Page)
Air Sync Group	Air Sync Group	82	WL_AIRSYNCGROUP_CS	207
CS Class	CS Class	82	WL_CLASS_CS	207
Super Master CS IP Address	IP Address	83	SUPERMASTER_IPADDR ESS_CS	207

CS Management

Web User Interface			Configuration File Parameter	
Section Title	Setting	Ref. (Page)	Parameter Name	Ref. (Page)
CS Registration	Air Sync Group	84	—	—
	Number of CS	84	—	—
CS Registered List	No.	84	—	—
	Index	84	—	—
	CS Name	85	—	—
	CS ID	85	—	—
	MAC Address	85	—	—
	IP Address	85	—	—
	CS Class	85	—	—

2.1.3 Web User Interface Setting List

Tree Survey

Web User Interface			Configuration File Parameter	
Section Title	Setting	Ref. (Page)	Parameter Name	Ref. (Page)
Tree Survey	Air Sync Group	86	—	—
Survey List	Index	87	—	—
	CS Name	87	—	—
	MAC Address	87	—	—
	CS Class	87	—	—
	Status	87	—	—
	Primary CS Index	88	—	—
	Secondary CS Index	88	—	—
	Level	88	—	—

CS Monitor

Web User Interface			Configuration File Parameter	
Section Title	Setting	Ref. (Page)	Parameter Name	Ref. (Page)
CS Monitor	Air Sync Group	89	—	—
	Index	89	—	—
	RSSI	89	—	—
	Error Rate	90	—	—
	Wired LAN	90	—	—
	CS Name	90	—	—
	MAC Address	90	—	—
	Status	91	—	—
	Current Sync CS	—	—	—
	CS Type	91	—	—
	CS RPT	91	—	—
	CS Index	91	—	—

PS Registration

Web User Interface			Configuration File Parameter	
Section Title	Setting	Ref. (Page)	Parameter Name	Ref. (Page)
PS tab screen		—	—	—

Web User Interface			Configuration File Parameter	
Section Title	Setting	Ref. (Page)	Parameter Name	Ref. (Page)
PS Registration	No.	92	—	—
	PS Name	92	PROFILE_NAME_PSy	223
	Phone Number	92	PHONE_NUMBER_PSy_n	221
	Wireless Status	93	—	—

PS Registration - Start PS Registration

Web User Interface			Configuration File Parameter	
Section Title	Setting	Ref. (Page)	Parameter Name	Ref. (Page)
PS Lists		93	—	—

PS Registration - Delete PS Registration

Web User Interface			Configuration File Parameter	
Section Title	Setting	Ref. (Page)	Parameter Name	Ref. (Page)
PS Lists		93	—	—

PS Registration - PS Settings

Web User Interface			Configuration File Parameter	
Section Title	Setting	Ref. (Page)	Parameter Name	Ref. (Page)
PIN Code	PIN Code	94	WL_PSREGISTRATION_PIN	207

VoIP

SIP Settings

Web User Interface			Configuration File Parameter	
Section Title	Setting	Ref. (Page)	Parameter Name	Ref. (Page)
SIP Setting	SIP User Agent	95	SIP_USER_AGENT	221

2.1.3 Web User Interface Setting List

Web User Interface			Configuration File Parameter	
Section Title	Setting	Ref. (Page)	Parameter Name	Ref. (Page)
SIP Server	Registrar Server Address	96	SIP_RGSTR_ADDR	225
	Registrar Server Port	96	SIP_RGSTR_PORT	225
	Proxy Server Address	96	SIP_PRXY_ADDR	224
	Proxy Server Port	96	SIP_PRXY_PORT	224
	Presence Server Address	97	SIP_PRSNC_ADDR	231
	Presence Server Port	97	SIP_PRSNC_PORT	231
Outbound Proxy Server	Outbound Proxy Server Address	97	SIP_OUTPROXY_ADDR	235
	Outbound Proxy Server Port	97	SIP_OUTPROXY_PORT	235
SIP Service Domain	Service Domain	97	SIP_SVCDOMAIN	225
DNS	Enable DNS SRV lookup	98	SIP_DNSSRV_ENA	229
	SRV lookup Prefix for UDP	98	SIP_UDP_SRV_PREFIX	229
	SRV lookup Prefix for TCP	98	SIP_TCP_SRV_PREFIX	229
Transport Protocol of SIP	Transport Protocol	98	SIP_TRANSPORT	235
Timer Settings	T1 Timer	99	SIP_TIMER_T1	227
	T2 Timer	99	SIP_TIMER_T2	227
	Timer B	99	SIP_TIMER_B	237
	Timer D	99	SIP_TIMER_D	237
	Timer F	100	SIP_TIMER_F	237
	Timer H	100	SIP_TIMER_H	238
	Timer J	100	SIP_TIMER_J	238
Quality of Service (QoS)	SIP Packet QoS (DSCP)	100	DSCP_SIP	226
SIP extensions	Supports 100rel (RFC 3262)	100	SIP_100REL_ENABLE	230
	Supports Session Timer (RFC 4028)	101	SIP_SESSION_TIME	226
Security	Enable SSAF (SIP Source Address Filter)	101	SIP_DETECT_SSAF	236

SIP Settings - PS

Web User Interface			Configuration File Parameter	
Section Title	Setting	Ref. (Page)	Parameter Name	Ref. (Page)
PS tab screen		—	—	—

Web User Interface			Configuration File Parameter	
Section Title	Setting	Ref. (Page)	Parameter Name	Ref. (Page)
SIP Settings	No.	102	—	—
	PS Name	102	PROFILE_NAME_PSy	223
	Line No.	102	—	—
	Phone Number	102	PHONE_NUMBER_PSy_n	221
PS select screen		—	—	—
PS Name	PS Name	103	PROFILE_NAME_PSy	223
Phone Number	Phone Number	103	PHONE_NUMBER_PSy_n	221
	SIP URI	104	SIP_URI_PSy_n	222
SIP Authentication	Authentication ID	104	SIP_AUTHID_PSy_n	223
	Authentication Password	104	SIP_PASS_PSy_n	223
SIP Source Port	Source Port	104	SIP_SRC_PORT_PSy_n	224

VoIP Settings

Web User Interface			Configuration File Parameter	
Section Title	Setting	Ref. (Page)	Parameter Name	Ref. (Page)
RTP Settings	RTP Packet Time	105	RTP_PTIME	214
	Minimum RTP Port Number	106	RTP_PORT_MIN	213
	Maximum RTP Port Number	106	RTP_PORT_MAX	213
	Telephone-event Payload Type	106	TELEVENT_PAYLOAD	216
Quality of Service (QoS)	RTP Packet QoS (DSCP)	107	DSCP_RTP	211
Statistical Information	RTCP Enable	107	RTCP_ENABLE	214
	RTCP Interval	107	RTCP_INTVL	212
Jitter Buffer	Maximum Delay	107	MAX_DELAY	212
	Minimum Delay	108	MIN_DELAY	212
	Initial Delay	108	NOM_DELAY	213
DTMF	DTMF Type	108	OUTBANDDTMF	215
Call Hold	Supports RFC 2543 (c=0.0.0.0)	108	RFC2543_HOLD_ENABLE	216

2.1.3 Web User Interface Setting List

Web User Interface			Configuration File Parameter	
Section Title	Setting	Ref. (Page)	Parameter Name	Ref. (Page)
CODEC Preferences	G722	—	—	—
	Enable	109	CODEC_ENABLEx	210
	Priority	109	CODEC_PRIORITYx	211
	PCMA	—	—	—
	Enable	109	CODEC_ENABLEx	210
	Priority	109	CODEC_PRIORITYx	211
	G726-32	—	—	—
	Enable	110	CODEC_ENABLEx	210
	Priority	110	CODEC_PRIORITYx	211
	G729A	—	—	—
	Enable	110	CODEC_ENABLEx	210
	Priority	110	CODEC_PRIORITYx	211
	PCMU	—	—	—
	Enable	110	CODEC_ENABLEx	210
	Priority	110	CODEC_PRIORITYx	211

Telephone

Call Control

Web User Interface			Configuration File Parameter	
Section Title	Setting	Ref. (Page)	Parameter Name	Ref. (Page)
Common tab screen		—	—	—

Web User Interface			Configuration File Parameter	
Section Title	Setting	Ref. (Page)	Parameter Name	Ref. (Page)
Call Control	Send SUBSCRIBE to Voice Mail Server	112	VM_SUBSCRIBE_ENABLE	194
	Conference Server URI	112	CONFERENCE_SERVER_URI	194
	Inter-digit Timeout	112	INTDIGIT_TIM	195
	Timer for Dial Plan	112	MACRODIGIT_TIM	195
	International Call Prefix	113	INTERNATIONAL_ACCESS_CODE	196
	Country Calling Code	113	COUNTRY_CALLING_CODE	196
	National Access Code	113	NATIONAL_ACCESS_CODE	196
	Flash/Recall Button	113	FLASH_RECALL_TERMINATE	220
	Flash Hook Event	113	FLASHHOOK_CONTENT_TYPE	220
Call Rejection Phone Numbers	1–30	114	—	—
PS tab screen		—	—	—
Call Control	No.	114	—	—
	PS Name	115	PROFILE_NAME_PSy	223
	Line No. 1–2	115	—	—
	Phone Number	115	PHONE_NUMBER_PSy_n	221
PS select screen		—	—	—
PS Name	PS Name	116	PROFILE_NAME_PSy	223
Call Control	Default Line for Outgoing	116	DEFAULT_LINE_SELECT_PSy	196
Dial Plan	Dial Plan (max 500 columns)	116	DIAL_PLAN_PSy	217
	Call Even If Dial Plan Does Not Match	116	DIAL_PLAN_NOT_MATCH_ENABLE_PSy	218
Line select screen		—	—	—
PS Name	PS Name	117	PROFILE_NAME_PSy	223
Phone Number	Phone Number	118	PHONE_NUMBER_PSy_n	221

2.1.3 Web User Interface Setting List

Web User Interface			Configuration File Parameter	
Section Title	Setting	Ref. (Page)	Parameter Name	Ref. (Page)
Call Control	Display Name	118	DISPLAY_NAME_PSy_n	217
	Voice Mail Access Number	118	VM_NUMBER_PSy_n	217
	Enable Shared Call	118	SHARED_CALL_ENABLE_PSy_n	218
	Synchronize Do Not Disturb and Call Forward	119	FWD_DND_SYNCHRO_ENABLE_PSy_n	219
Call Features	Block Caller ID	119	—	—
	Block Anonymous Call	119	—	—
	Do Not Disturb	120	—	—
Call Forward	Unconditional	—	—	—
	Enable Call Forward	120	—	—
	Phone Number	121	—	—
	Busy	—	—	—
	Enable Call Forward	121	—	—
	Phone Number	122	—	—
	No Answer	—	—	—
	Enable Call Forward	122	—	—
	Phone Number	123	—	—
Ring Count	123	—	—	

Button Settings

Web User Interface			Configuration File Parameter	
Section Title	Setting	Ref. (Page)	Parameter Name	Ref. (Page)
PS tab screen		—	—	—
Button Settings	No.	124	—	—
	PS Name	124	PROFILE_NAME_PSy	223
	Phone Number	124	PHONE_NUMBER_PSy_n	221

Button Settings - PS

Web User Interface			Configuration File Parameter	
Section Title	Setting	Ref. (Page)	Parameter Name	Ref. (Page)
PS Name	PS Name	125	PROFILE_NAME_PSy	223

Web User Interface			Configuration File Parameter	
Section Title	Setting	Ref. (Page)	Parameter Name	Ref. (Page)
Flexible Button Settings	No.	125	—	—
	Type (No. 1–12)	126	FLEX_BUTTON_FACILITY_ACTx_PSy	209
	Parameter (No. 1–12)	126	FLEX_BUTTON_FACILITY_ARGx_PSy	209
	Label Name (No. 1–12)	126	FLEX_BUTTON_LABELx_PSy	210

Button Settings - Copy & Paste

Web User Interface			Configuration File Parameter	
Section Title	Setting	Ref. (Page)	Parameter Name	Ref. (Page)
Copy Source PS Name	PS Name	127	PROFILE_NAME_PSy	223
Copy Source Flexible Button Settings	No.	127	—	—
	Type (No. 1–12)	128	FLEX_BUTTON_FACILITY_ACTx_PSy	209
	Parameter (No. 1–12)	128	FLEX_BUTTON_FACILITY_ARGx_PSy	209
	Label Name (No. 1–12)	128	FLEX_BUTTON_LABELx_PSy	210

Tone Settings

Web User Interface			Configuration File Parameter	
Section Title	Setting	Ref. (Page)	Parameter Name	Ref. (Page)
Dial Tone	Tone Frequencies	129	DIAL_TONE1_FRQ	197
	Tone Timings	130	DIAL_TONE1_TIMING	198
Busy Tone	Tone Frequencies	130	BUSY_TONE_FRQ	200
	Tone Timings	130	BUSY_TONE_TIMING	201
Ringing Tone	Tone Frequencies	131	RINGBACK_TONE_FRQ	202
	Tone Timings	131	RINGBACK_TONE_TIMING	203
Stutter Tone	Tone Frequencies	131	DIAL_TONE4_FRQ	199
	Tone Timings	131	DIAL_TONE4_TIMING	200

2.1.3 Web User Interface Setting List

Web User Interface			Configuration File Parameter	
Section Title	Setting	Ref. (Page)	Parameter Name	Ref. (Page)
Reorder Tone	Tone Frequencies	132	REORDER_TONE_FRQ	201
	Tone Timings	132	REORDER_TONE_TIMING	202

Telephone Settings

Web User Interface			Configuration File Parameter	
Section Title	Setting	Ref. (Page)	Parameter Name	Ref. (Page)
Telephone Settings	Number Matching Lower Digit	132	NUMBER_MATCHING_LOWER_DIGIT	205
	Number Matching Upper Digit	133	NUMBER_MATCHING_UPPER_DIGIT	205

Import Phonebook

Web User Interface			Configuration File Parameter	
Section Title	Setting	Ref. (Page)	Parameter Name	Ref. (Page)
All tab screen		—	—	—
Import Mode	Mode Select	133	—	—
Import Time Setting	Date	—	—	—
	Date	134	—	—
	Month	134	—	—
	Year	134	—	—
	Time	—	—	—
	Hour	134	—	—
Minute	134	—	—	
Import Phonebook	File Name	134	—	—
PS tab screen		—	—	—
Import Phonebook	No.	135	—	—
	PS Name	135	PROFILE_NAME_PSy	223
	Phone Number	135	PHONE_NUMBER_PSy_n	221
PS select screen		—	—	—
PS Name	PS Name	136	PROFILE_NAME_PSy	223
Import Phonebook	File Name	136	—	—

Export Phonebook

Web User Interface			Configuration File Parameter	
Section Title	Setting	Ref. (Page)	Parameter Name	Ref. (Page)
PS tab screen			—	—
Export Phonebook			—	—
Export Phonebook	PS Name	137	PROFILE_NAME_PSy	223
	Phone Number	137	PHONE_NUMBER_PSy_n	221

Maintenance**Backup**

Web User Interface			Configuration File Parameter	
Section Title	Setting	Ref. (Page)	Parameter Name	Ref. (Page)
Backup			—	—

Restore

Web User Interface			Configuration File Parameter	
Section Title	Setting	Ref. (Page)	Parameter Name	Ref. (Page)
Restore			—	—

Firmware Maintenance

Web User Interface			Configuration File Parameter	
Section Title	Setting	Ref. (Page)	Parameter Name	Ref. (Page)
Firmware Maintenance	Enable Firmware Update	139	FIRM_UPGRADE_ENABLE	174
	Firmware File URL	139	FIRM_FILE_PATH	175
	PS Update Type	140	PS_FIRM_UPGRADE_AUTO	175

2.1.3 Web User Interface Setting List

Firmware Maintenance

Web User Interface			Configuration File Parameter	
Section Title	Setting	Ref. (Page)	Parameter Name	Ref. (Page)
Firmware Maintenance	Enable Firmware Update	139	FIRM_UPGRADE_ENABLE	174
	Firmware File URL	139	FIRM_FILE_PATH	175
	PS Update Type	140	PS_FIRM_UPGRADE_AUTO	175

All Firmware Update

Web User Interface			Configuration File Parameter	
Section Title	Setting	Ref. (Page)	Parameter Name	Ref. (Page)
Update Mode	Mode	141	—	—
Update Time Setting	Date	—	—	—
	Date	141	—	—
	Month	141	—	—
	Year	141	—	—
	Time	—	—	—
	Hour	141	—	—
Update Firmware	Minute	141	—	—
	Encryption	141	—	—
	File Name	141	—	—

Provisioning Maintenance

Web User Interface			Configuration File Parameter	
Section Title	Setting	Ref. (Page)	Parameter Name	Ref. (Page)
Provisioning Maintenance	Enable Provisioning	143	PROVISION_ENABLE	177
	Standard File URL	143	CFG_STANDARD_FILE_PATH	177
	Product File URL	143	CFG_PRODUCT_FILE_PATH	178
	Master File URL	143	CFG_MASTER_FILE_PATH	179
	System File URL	144	CFG_SYSTEM_FILE_PATH	180
	Cyclic Auto Resync	144	CFG_CYCLIC	183
	Resync Interval	144	CFG_CYCLIC_INTVL	183
	Header Value for Resync Event	144	CFG_RESYNC_FROM_SIP	184

Error Log

Web User Interface			Configuration File Parameter	
Section Title	Setting	Ref. (Page)	Parameter Name	Ref. (Page)
Error Log		145	—	—

Restart

Web User Interface			Configuration File Parameter	
Section Title	Setting	Ref. (Page)	Parameter Name	Ref. (Page)
Restart		145	—	—

Controls on the Window

The Web user interface window contains various controls for navigating and configuring settings. The following figure shows the controls that are displayed on the **[Basic Network Settings]** screen as an example:

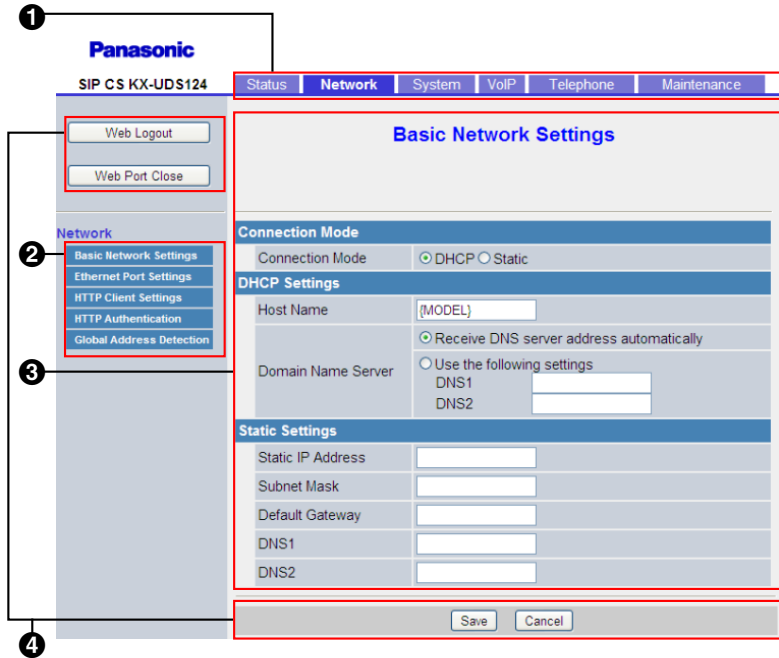

Note

- Actual default values may vary depending on your dealer.

1 Tabs

Tabs are the top categories for classifying settings. When you click a tab, the corresponding menu items and the configuration screen of the first menu item appear. There are 6 tabs for the Administrator account.

2 Menu

The menu displays the sub-categories of the selected tab.

3 Configuration Screen

Clicking a menu displays the corresponding configuration screen, which contains the actual settings, grouped into sections. For details, see **2.2 Status** to **2.7.7 Restart**.

4 Buttons

The following standard buttons are displayed in the Web user interface:

Button	Function
Web Logout	Logs out from Web programming.
Web Port Close	Closes the Web port of the SIP-CS and logs you out of the Web user interface after a confirmation message is displayed.
Save	Saves settings for the SIP-CS that is being configured.
Cancel	Discards changes. The settings on the current screen will return to the values they had before being changed.
Collection Start	Starts collecting information necessary for SIP-CS synchronization.
Collection Stop	Stops collecting information necessary for SIP-CS synchronization.
All Save	Saves the same settings for all SIP-CSs.

Button	Function
Back	Returns to the previous screen.
Change User Password	Changes the password used to authenticate the User account.
Tree Image	Displays an image of the tree structure.
Next	Proceeds to the next process.
Import	Imports phonebook data to the specified SIP-CS or S-PS only.
All Import	Imports phonebook data to all SIP-CSs or S-PSs.
All Update Firmware	Updates the firmware of all SIP-CSs.
Update Firmware	Updates the firmware of the specified SIP-CS only.
Execute	Executes the process on the current screen (e.g., opens the TELNET port).
Restart	Restarts the SIP-CS that is being configured.
Start CS Registration	Starts the SIP-CS registration.
Stop CS Registration	Stops the SIP-CS registration.
Delete CS Registration	Deletes the registration of the selected SIP-CS.
Stop PS Registration	Stops the S-PS registration.
Apply	Applies changes or the Tree Survey results to the relevant SIP-CS.
Start PS Registration	Starts the S-PS registration.
Delete PS Registration	Deletes the S-PS registration.
Linex SIP Setting	Displays the SIP settings screen for the S-PS of the selected line.
PS Call Control	Displays the call control settings screen for the selected S-PS.
Linex Call Control	Displays the call control settings screen for the S-PS of the selected line.
Button Settings	Displays the flexible button settings screen.
Copy & Paste	Copies the flexible button settings for an S-PS and applies them to other S-PSs.
Import Phonebook	Displays the import phonebook screen.
Start Tree Survey	Starts the Tree Survey.
Browse	Locates the file to be imported or updated.
Refresh	Updates the status information displayed on the screen. This button is displayed in the upper-right area of the [Network Status] screen.
Monitor Start	Starts monitoring the SIP-CS.
Monitor Stop	Stops monitoring the SIP-CS.
Export Phonebook	Displays the [Export Phonebook] screen for the selected S-PS.
Login	Logs in to the Web user interface for the selected SIP-CS.

Result Messages

When you click **[Save]** after changing the settings on the current configuration screen, one of the following messages will appear in the upper-left area of the current configuration screen:

Result Message	Description	Applicable Screens
Complete	The operation has successfully completed.	All screens except <ul style="list-style-type: none"> 2.2.3 CS Version List 2.2.5 PS Information 2.4.9 CS Management 2.4.10 Tree Survey 2.4.12 PS Registration 2.6.13 Export Phonebook - PS
Failed (Parameter Error)	The operation failed because: <ul style="list-style-type: none"> Some specified values are out of range or invalid. 	All screens
Failed (Memory Access Error)	The operation failed because: <ul style="list-style-type: none"> Access error to the flash memory occurred while reading or writing the data. 	All screens
	<ul style="list-style-type: none"> A flash error occurred in reply to a SIP-CS synchronization error. 	2.6.10 Import Phonebook - All
	<ul style="list-style-type: none"> The sent data was not created correctly. 	2.6.13 Export Phonebook - PS
	<ul style="list-style-type: none"> A flash error occurred while restoring the data. 	2.7.2 Restore
Failed (Busy)	The operation failed because: <ul style="list-style-type: none"> The SIP-CS is performing an operation that accesses the flash memory of the SIP-CS. 	All screens
	<ul style="list-style-type: none"> HSAPP resources cannot be reserved. (The SIP-CS is busy.) 	2.6.11 Import Phonebook - PS
	<ul style="list-style-type: none"> The specified S-PS is on a call. (The S-PS's busy status is known in status management.) 	2.6.11 Import Phonebook - PS
	<ul style="list-style-type: none"> The specified S-PS is busy. (The S-PS's busy status is not known in status management.) 	2.6.11 Import Phonebook - PS
	<ul style="list-style-type: none"> The SIP-CS is busy. (e.g., The flash memory is in use.) 	2.7.1 Backup 2.7.2 Restore

Result Message	Description	Applicable Screens
Failed (Invalid File)	The operation failed because: <ul style="list-style-type: none"> The firmware file is corrupted or invalid. 	2.7.4 All Firmware Update
	<ul style="list-style-type: none"> Analysis of the received data failed. 	2.6.11 Import Phonebook - PS
	<ul style="list-style-type: none"> The backup data is corrupted or invalid. Select the correct backup data. 	2.7.2 Restore
Failed (File Size Error)	The operation failed because: <ul style="list-style-type: none"> The size of the imported phonebook is too large. 	2.6.10 Import Phonebook - All 2.6.11 Import Phonebook - PS
	<ul style="list-style-type: none"> The size of the firmware file is insufficient. 	2.7.4 All Firmware Update
Failed (Firmware Version Mismatch)	The operation failed because: <ul style="list-style-type: none"> The firmware version of the Super Master CS to be restored does not match the firmware version of the Super Master CS with which the backup file was created. Update the Super Master CS firmware to the version with which the backup file was created. <p>Note</p> <ul style="list-style-type: none"> The file name of the backup data includes the CS firmware version with which the file was created. If the name of the backup data is "backup_UDS_00.031.bin", the firmware version of the Super Master CS is version 00.031. 	2.7.1 Backup 2.7.2 Restore
Failed (Time Un-setting)	The operation failed because: <ul style="list-style-type: none"> The time has not been set on the SIP-CS. 	2.6.10 Import Phonebook - All 2.7.4 All Firmware Update
Failed (Past Time)	The operation failed because: <ul style="list-style-type: none"> The specified time is a time in the past. 	2.6.10 Import Phonebook - All
Failed (No Handset, or Busy)	The operation failed because: <ul style="list-style-type: none"> The specified S-PS is not registered. (It cannot be found in an S-PS search via SIP-CS synchronization.) 	2.6.11 Import Phonebook - PS
	<ul style="list-style-type: none"> The specified S-PS cannot be connected to. 	2.6.11 Import Phonebook - PS

2.1.3 Web User Interface Setting List

Result Message	Description	Applicable Screens
Failed (No Reception)	The operation failed because: <ul style="list-style-type: none"> The connection to the specified S-PS suddenly cuts out (becomes out of range). 	2.6.11 Import Phonebook - PS
	<ul style="list-style-type: none"> An error occurred on the specified S-PS while importing data. 	2.6.11 Import Phonebook - PS
	<ul style="list-style-type: none"> An error occurred on the specified S-PS while exporting data. 	2.6.13 Export Phonebook - PS
Failed (CS Link Failure)	The operation failed because: <ul style="list-style-type: none"> A SIP-CS synchronization failure occurred (due to a network failure etc.). 	2.6.11 Import Phonebook - PS
Failed (Config PS Registering)	The operation failed because: <ul style="list-style-type: none"> There was a conflict of IPEI numbers during the S-PS registration process. 	2.4.12 PS Registration
Failed (Charge Battery)	The operation failed because: <ul style="list-style-type: none"> The battery needs to be charged. 	2.6.13 Export Phonebook - PS
Memory Full	The operation failed because: <ul style="list-style-type: none"> The imported phonebook data contains more than 500 entries. 	2.6.11 Import Phonebook - PS
No Data	The operation failed because: <ul style="list-style-type: none"> No phonebook entry is registered in the specified S-PS. 	2.6.13 Export Phonebook - PS
No checkbox	The operation failed because: <ul style="list-style-type: none"> The SIP-CS selected via check box does not exist. 	2.4.9 CS Management
Collecting	Data is being collected.	2.2.4 CS Information 2.2.6 PS VoIP Status
Trying...	A process is being executed.	2.4.9 CS Management 2.4.10 Tree Survey 2.4.12 PS Registration
CS Registration Complete	SIP-CS registration is complete.	2.4.9 CS Management
CS Registration Stop	SIP-CS registration has been canceled.	2.4.9 CS Management
CS Registration Timeout	The specified number of SIP-CSs has not been registered.	2.4.9 CS Management
CS Delete Complete	The SIP-CS has been deleted successfully.	2.4.9 CS Management
Tree Survey Complete	Tree Survey has completed.	2.4.10 Tree Survey
Tree Survey Stop	Tree Survey has been canceled.	2.4.10 Tree Survey
Apply Complete	Settings have been applied successfully.	2.4.10 Tree Survey
Monitoring...	Monitoring is being executed.	2.4.11 CS Monitor

Result Message	Description	Applicable Screens
Stop	A process has been canceled.	2.2.4 CS Information 2.2.6 PS VoIP Status 2.4.11 CS Monitor
PS Registration Complete	S-PS registration is complete.	2.4.12 PS Registration
PS Registration Stop	S-PS registration has been canceled.	2.4.12 PS Registration
PS Delete Complete	The S-PS has been deleted successfully.	2.4.12 PS Registration

Notice

- Do not click the navigation buttons of your Web browser or open a new window to display the screen. Otherwise, an error ("403 Forbidden") will occur when you click **[Save]**.

2.2 Status

This section provides detailed descriptions about all the settings classified under the **[Status]** tab.

2.2.1 Version Information

This screen allows you to view the current version information such as the model number and the firmware version of the SIP-CS.



2.2.1.1 CS Version Information

Model

Description	Indicates the model number of the SIP-CS (reference only).
Value Range	KX-UDS124
Default Value	Current model number

Operating Bank

Description	Indicates the storage area of the SIP-CS firmware that is currently operating (reference only).
Value Range	<ul style="list-style-type: none"> • Bank1 • Bank2
Default Value	Not applicable.

IPL Version

Description	Indicates the version of the IPL (Initial Program Load) that runs when starting the SIP-CS (reference only).
Value Range	IPL version ("nn.nn" [n=0–9])
Default Value	Current IPL version

Firmware Version

Description	Indicates the version of the firmware that is currently installed on the SIP-CS (reference only).
Value Range	Bank1 (Bank2): Firmware version ("nn.nnn" [n=0–9]), -
Default Value	Not applicable.

2.2.1.2 PS Version Information (Model 1)

Model

Description	Indicates the model number of the listed S-PS (reference only).
Value Range	KX-UDT111, - , ...
Default Value	Not applicable.

Firmware Version

Description	Indicates the version of the firmware of the listed S-PS (reference only).
Value Range	Firmware version ("nn.nn.nnn" [n=0–9]), - , ...
Default Value	Not applicable.

2.2.1.3 PS Version Information (Model 2)

Model

Description	Indicates the model number of the listed S-PS (reference only).
Value Range	KX-UDT121/KX-UDT131, - , ...
Default Value	Not applicable.

Firmware Version

Description	Indicates the version of the firmware of the listed S-PS (reference only).
--------------------	--

2.2.2 Network Status

Value Range	Firmware version ("nn.nn.nnn" [n=0–9]), - , ...
Default Value	Not applicable.

2.2.1.4 PS Version Information (Model 3)

Model

Description	Indicates the model number of the listed S-PS (reference only).
Value Range	- , ...
Default Value	Not applicable.

Firmware Version

Description	Indicates the version of the firmware of the listed S-PS (reference only).
Value Range	Firmware version ("nn.nn.nnn" [n=0–9]), - , ...
Default Value	Not applicable.

2.2.2 Network Status

This screen allows you to view the current network information of the SIP-CS, such as the MAC address, IP address, Ethernet port status, etc.

Panasonic
SIP CS KX-UDS124

Web Logout | Web Port Close | Refresh

Network Status

Version Information	Network Status
CS Version List	CS Information
PS Information	PS VoIP Status

MAC Address	0080F0E975F9
Ethernet Link Status (LAN Port)	Connected
Connection Mode	DHCP
IP Address	192.168.0.38
Subnet Mask	255.255.255.0
Default Gateway	192.168.0.10
DNS1	192.168.0.10
DNS2	

2.2.2.1 Network Status

MAC Address

Description	Indicates the MAC address of the SIP-CS (reference only).
Value Range	Not applicable.

Default Value	Not applicable.
----------------------	-----------------

Ethernet Link Status (LAN Port)

Description	Indicates the current connection status of the Ethernet LAN port (reference only).
Value Range	<ul style="list-style-type: none"> Connected
Default Value	Not applicable.

Connection Mode

Description	Indicates whether the IP address of the SIP-CS is assigned automatically (DHCP) or manually (static) (reference only).
Value Range	<ul style="list-style-type: none"> DHCP Static
Default Value	DHCP

IP Address

Description	Indicates the currently assigned IP address of the SIP-CS (reference only).
Value Range	IP address
Default Value	Not applicable.

Subnet Mask

Description	Indicates the specified subnet mask for the SIP-CS (reference only).
Value Range	Subnet mask
Default Value	Not applicable.

Default Gateway

Description	<p>Indicates the specified IP address of the default gateway for the network (reference only).</p> <p>Note</p> <ul style="list-style-type: none"> If the default gateway address is not specified, this field will be left blank.
Value Range	IP address of the default gateway
Default Value	Not applicable.

2.2.3 CS Version List

DNS1

Description	Indicates the specified IP address of the primary DNS server (reference only). Note <ul style="list-style-type: none">If the primary DNS server address is not specified, this field will be left blank.
Value Range	IP address of the primary DNS server
Default Value	Not applicable.

DNS2

Description	Indicates the specified IP address of the secondary DNS server (reference only). Note <ul style="list-style-type: none">If the secondary DNS server address is not specified, this field will be left blank.
Value Range	IP address of the secondary DNS server
Default Value	Not applicable.

2.2.3 CS Version List

This screen allows you to view current version information such as the model number and the firmware version of the SIP-CS that belongs to a particular Air Sync Group.

Panasonic
SIP CS KX-UDS124 | Status | Network | System | VoIP | Telephone | Maintenance

Web Logout | Web Port Close

CS Version List

Air Sync Group: 1

CS Name	CS ID	MAC Address	Firmware Version
	0018E66300	00.80.F0.E9.75.F9	00.030

2.2.3.1 CS Version List

Air Sync Group

Description	Selects the number of the Air Sync Group to be displayed.
Value Range	1–8

Default Value	Not stored.
----------------------	-------------

CS Name

Description	Indicates the name of the SIP-CS that belongs to the Air Sync Group of the selected number (reference only).
Value Range	Max. 20 characters
Default Value	Not applicable.

CS ID

Description	Indicates the ID of the SIP-CS that belongs to the Air Sync Group of the selected number (reference only).
Value Range	10 characters
Default Value	Not applicable.

MAC Address

Description	Indicates the MAC address of the SIP-CS that belongs to the Air Sync Group of the selected number (reference only).
Value Range	Not applicable.
Default Value	Not applicable.

Firmware Version

Description	Indicates the firmware version of the SIP-CS that belongs to the Air Sync Group of the selected number (reference only).
Value Range	Firmware version ("nn.nnn" [n=0–9])
Default Value	Not applicable.

2.2.4 CS Information

This screen allows you to view information such as the service status and the path of the SIP-CS that belongs to a particular Air Sync Group.

2.2.4 CS Information

Note

- After clicking **[Collection Start]**, the SIP-CS will continue to gather information for 15 seconds until **[Collection Stop]** is clicked.

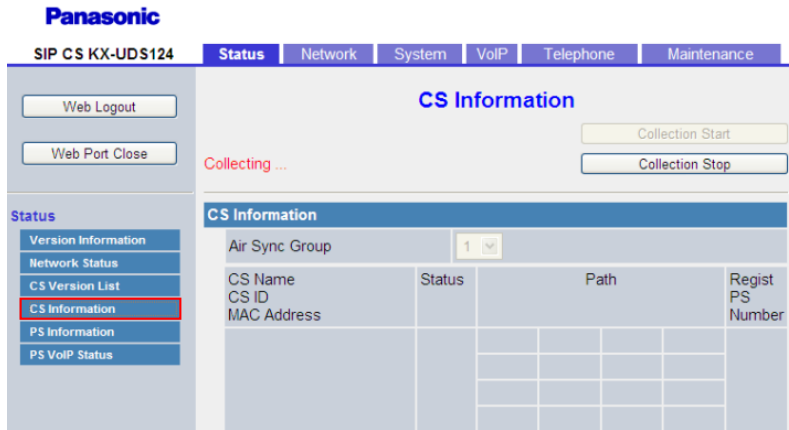

2.2.4.1 CS Information

Air Sync Group

Description	Selects the number of the Air Sync Group to be displayed.
Value Range	1–8
Default Value	Not stored.

CS Name

Description	Indicates the name of the SIP-CS that belongs to the Air Sync Group of the selected number (reference only).
Value Range	Max. 20 characters
Default Value	Not applicable.

CS ID

Description	Indicates the ID of the SIP-CS that belongs to the Air Sync Group of the selected number (reference only).
Value Range	10 characters
Default Value	Not applicable.

MAC Address

Description	Indicates the MAC address of the SIP-CS that belongs to the Air Sync Group of the selected number (reference only).
--------------------	---

Value Range	Not applicable.
Default Value	Not applicable.

Status

Description	Indicates the service status of the SIP-CS that belongs to the Air Sync Group of the selected number (reference only).
Value Range	<ul style="list-style-type: none"> INS - (not available)
Default Value	Not applicable.

Path 1–16

Description	Indicates the status of the path of the SIP-CS that belongs to the Air Sync Group of the selected number (reference only). Note <ul style="list-style-type: none"> Total 8 paths (Max. 4 paths for talking; max. 8 paths for Handover) ^{*1}
Value Range	<ul style="list-style-type: none"> OFF 2 characters ("H ") + 1–32 digits 1–32 digits Note <ul style="list-style-type: none"> "-" means that the path is unused.
Default Value	Not applicable.

^{*1} When the handover happens, the call is redirected from the original CS to a latest CS. The handover call requires processing power of the original CS during the call. The CS's processing power resource is limited and shared by calls (include handover calls) as below.

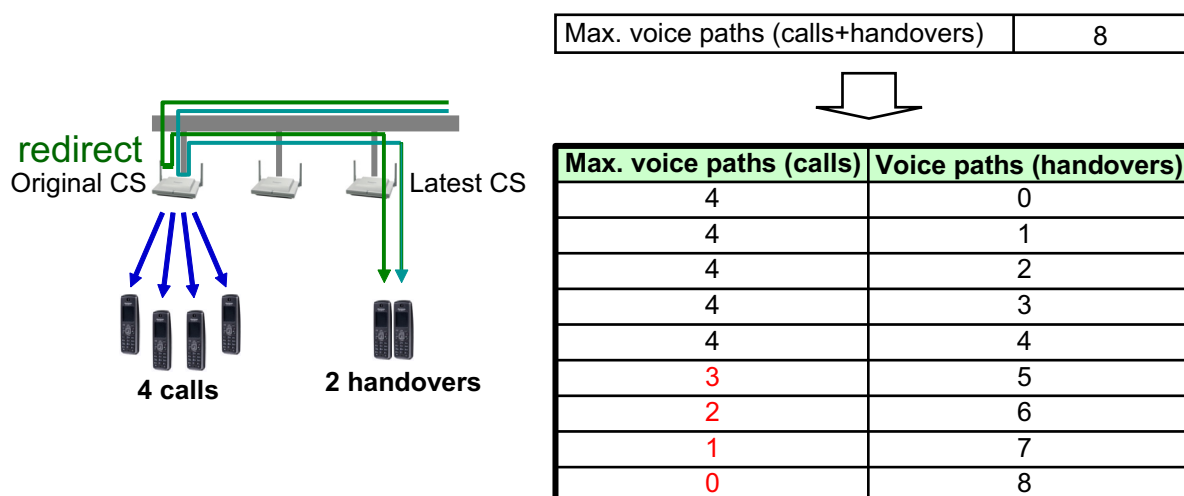

2.2.5 PS Information

Regist PS Number

Description	Indicates the number of S-PSs registered to the SIP-CS that belongs to the Air Sync Group of the selected number (reference only).
Value Range	0–32
Default Value	Not applicable.

2.2.5 PS Information

This screen allows you to view information such as the model number, the firmware version, and the phonebook import record of the S-PSs that are registered to the SIP-CS. Click a numbered tab to view this screen for a particular S-PS.

The screenshot shows the Panasonic SIP CS KX-UDS124 web interface. The main navigation bar includes tabs for Status, Network, System, VoIP, Telephone, and Maintenance. The 'Status' tab is selected, and the 'PS Information' screen is displayed. The screen features a 'Web Logout' and 'Web Port Close' button. A sidebar menu on the left lists various status-related options, with 'PS Information' highlighted. The main content area shows a table titled 'PS Information' with columns for 'No.', 'PS Name', 'Model', 'Firmware Version', and 'Phonebook Import Time [Result]'. The table is currently empty, showing only the header row and five numbered rows (1-5).

2.2.5.1 PS Information

No.

Description	Indicates the table number of the S-PS that is registered to the SIP-CS (reference only).
Value Range	1–255
Default Value	Not applicable.

PS Name

Description	Indicates the currently assigned name of the S-PS (reference only).
Value Range	Max. 20 characters
Default Value	Not applicable.

Model

Description	Indicates the model number of the S-PS that is registered to the SIP-CS (reference only).
Value Range	<ul style="list-style-type: none"> • KX-UDT111 • KX-UDT121 • KX-UDT131
Default Value	Not applicable.

Firmware Version

Description	Indicates the firmware version of the S-PS that is registered to the SIP-CS (reference only).
Value Range	Firmware version ("nn.nn.nnn" [n=0–9])
Default Value	Not applicable.

Phonebook Import Time [Result]

Description	Indicates the time that phonebook data is imported to S-PSs when importing phonebook data to all S-PSs (→ see 2.6.10 Import Phonebook - All). The information in brackets ([]) indicates the import result (reference only).
Value Range	"nn/nn/nnnn nn:nn [xxxxxxxxxxxxxxxxxxxxxx]" Note <ul style="list-style-type: none"> • When the SIP-CS's time is not set, "-" will be displayed.
Default Value	Not applicable.

2.2.6 PS VoIP Status

This screen allows you to view the information of the SIP-CS to which each S-PS is connected, and the phone number and VoIP status of each S-PS.

2.2.6 PS VoIP Status

Click a numbered tab to view this screen for a particular S-PS.

2.2.6.1 PS VoIP Status

No.

Description	Indicates the table number of the S-PS that is registered to the SIP-CS (reference only).
Value Range	1–255
Default Value	Not applicable.

PS Name

Description	Indicates the currently assigned name of the S-PS (reference only).
Value Range	Max. 20 characters
Default Value	Not applicable.

Location CS Name

Description	Indicates the name of the SIP-CS to which the S-PS is currently connected (reference only).
Value Range	Max. 20 characters
Default Value	Not applicable.

Location CS MAC

Description	Indicates the MAC address of the SIP-CS to which the S-PS is currently connected (reference only).
Value Range	Not applicable.

Default Value	Not applicable.
----------------------	-----------------

Phone Number

Description	Indicates the currently assigned phone numbers (reference only). Note <ul style="list-style-type: none"> The corresponding field is blank if a line has not yet been leased or if the SIP-CS has not been configured.
Value Range	Max. 32 digits
Default Value	Not applicable.

VoIP Status

Description	Indicates the current VoIP status of each line of the SIP-CS to which the S-PS is currently connected (reference only).
Value Range	<ul style="list-style-type: none"> 200 OK: The SIP-CS has been registered to the SIP server, and the line can be used. Registering: The SIP-CS is being registered to the SIP server, and the line cannot be used. Blank: The line has not been leased, the SIP-CS has not been configured yet, or a SIP authentication failure has occurred. DNS Error: Registration to the server failed due to a DNS error. No Response: Registration to the server failed. There is no response from the server. SIP Error(xxx): Registration to the server failed. An error number (xxx) was returned from the server. Internal Status Error: Registration to the server failed due to an internal cause. Note <ul style="list-style-type: none"> Immediately after starting up the SIP-CS, the phone numbers of the lines will be displayed, but the status of the line may not be displayed because the SIP-CS is still being registered to the SIP server. When not performing SIP registration, "-" is displayed.
Default Value	Not applicable.

2.3 Network

This section provides detailed descriptions about all the settings classified under the **[Network]** tab.

2.3.1 Basic Network Settings

This screen allows you to change basic network settings such as whether to use a DHCP server, and the IP address of the SIP-CS.

Note

- Changes to the settings on this screen are applied when the message "Complete" appears after clicking **[Save]**. Because the IP address of the SIP-CS will probably be changed if you change these settings, you will not be able to continue using the Web user interface. To continue configuring the SIP-CS from the Web user interface, log in to the Web user interface again after confirming the newly assigned IP address of the SIP-CS. In addition, if the IP address of the PC from which you try to access the Web user interface has been changed, close the Web port once by clicking **[Web Port Close]**.

Panasonic
SIP CS KX-UDS124

Status | **Network** | System | VoIP | Telephone | Maintenance

Web Logout | Web Port Close

Basic Network Settings

Network

- Basic Network Settings** (highlighted)
- HTTP Client Settings
- HTTP Authentication
- Global Address Detection

Connection Mode

Connection Mode: DHCP Static

DHCP Settings

Host Name: (MODEL)

Receive DNS server address automatically

Use the following settings

Domain Name Server: DNS1, DNS2

Static Settings

Static IP Address: 192.168.0.100

Subnet Mask: 255.255.255.0

Default Gateway: 192.168.0.1

DNS1, DNS2

Link Speed/Duplex Mode

LAN Port: Auto Negotiation

The CS reboots automatically if you change the settings on this item.

LLDP Settings

Enable LLDP: Yes No

LLDP-MED Interval timer: 30 seconds [1-3600]

IP Phone: VLAN ID, Priority

The CS reboots automatically if you change the settings on this item.

VLAN Settings

Enable VLAN: Yes No

IP Phone: VLAN ID: 2 [1-4094], Priority: 7

The CS reboots automatically if you change the settings on this item.

Save | Cancel

2.3.1.1 Connection Mode

Connection Mode

Description	Selects whether to assign the IP address automatically (DHCP) or manually (static).
--------------------	---

Value Range	<ul style="list-style-type: none"> • DHCP • Static
Default Value	DHCP

2.3.1.2 DHCP Settings

Host Name

Description	<p>Specifies the host name for the SIP-CS to send to the DHCP server.</p> <p>Note</p> <ul style="list-style-type: none"> • This setting is available only when [Connection Mode] is set to [DHCP].
Value Range	Max. 63 characters
Default Value	{MODEL}

Domain Name Server

Description	<p>Selects whether to receive DNS server addresses automatically or to assign a DNS server addresses (up to 2) manually.</p> <p>Note</p> <ul style="list-style-type: none"> • This setting is available only when [Connection Mode] is set to [DHCP].
Value Range	<ul style="list-style-type: none"> • Receive DNS server address automatically • Use the following settings <ul style="list-style-type: none"> – DNS1 – DNS2 <p>Note</p> <ul style="list-style-type: none"> • If you select [Use the following settings], specify the IP address(es) of the primary and, if necessary, secondary DNS server(s) manually. The permissible values are: Max. 15 characters ("n.n.n.n" [n=0–255], except "0.0.0.0", "255.255.255.255", "127.0.0.1", etc.)
Default Value	Receive DNS server address automatically

2.3.1.3 Static Settings

Static IP Address

Description	Specifies the IP address for the SIP-CS. Note <ul style="list-style-type: none"> This setting is available only when [Connection Mode] is set to [Static].
Value Range	Max. 15 characters ("n.n.n.n" [n=0–255], except "0.0.0.0", "255.255.255.255", "127.0.0.1", etc.)
Default Value	Not stored.

Subnet Mask

Description	Specifies the subnet mask for the SIP-CS. Note <ul style="list-style-type: none"> This setting is available only when [Connection Mode] is set to [Static].
Value Range	Max. 15 characters ("n.n.n.n" [n=0–255], except "0.0.0.0", "255.255.255.255", "127.0.0.1", etc.)
Default Value	Not stored.

Default Gateway

Description	Specifies the IP address of the default gateway for the network where the SIP-CS is connected. Note <ul style="list-style-type: none"> This setting is available only when [Connection Mode] is set to [Static].
Value Range	Max. 15 characters ("n.n.n.n" [n=0–255], except "0.0.0.0", "255.255.255.255", "127.0.0.1", etc.)
Default Value	Not stored.

DNS1

Description	Specifies the IP address of the primary DNS server. Note <ul style="list-style-type: none"> This setting is available only when [Connection Mode] is set to [Static].
Value Range	Max. 15 characters ("n.n.n.n" [n=0–255], except "0.0.0.0", "255.255.255.255", "127.0.0.1", etc.)

Default Value	Not stored.
---------------	-------------

DNS2

Description	Specifies the IP address of the secondary DNS server. Note <ul style="list-style-type: none"> This setting is available only when [Connection Mode] is set to [Static].
Value Range	Max. 15 characters ("n.n.n.n" [n=0–255], except "0.0.0.0", "255.255.255.255", "127.0.0.1", etc.)
Default Value	Not stored.

2.3.1.4 Link Speed/Duplex Mode

LAN Port

Description	Selects the connection mode (link speed and duplex mode) of the LAN port.
Value Range	<ul style="list-style-type: none"> Auto Negotiation 100 Mbps/Full Duplex 100 Mbps/Half Duplex 10 Mbps/Full Duplex 10 Mbps/Half Duplex
Default Value	Auto Negotiation

2.3.1.5 LLDP Settings

Enable LLDP

Description	Selects whether to enable or disable sending and receiving LLDP frames.
Value Range	<ul style="list-style-type: none"> Y (Enable) N (Disable)
Default Value	Y

LLDP-MED Interval timer

Description	Specifies the interval, in seconds, between sending each LLDP frame.
Value Range	1–3600
Default Value	30

IP Phone (VLAN ID)

Description	Indicates the VLAN ID for the SIP-CS (reference only).
Value Range	1–4094
Default Value	Not applicable.

IP Phone (Priority)

Description	Indicates the priority number for the SIP-CS (reference only).
Value Range	0–7
Default Value	Not applicable.

2.3.1.6 VLAN Settings

Enable VLAN

Description	Selects whether to use the VLAN feature to perform VoIP communication securely.
Value Range	<ul style="list-style-type: none">• Yes• No
Default Value	No

IP Phone (VLAN ID)

Description	Specifies the VLAN ID for this SIP-CS.
Value Range	1–4094
Default Value	2

IP Phone (Priority)

Description	Selects the priority number for the SIP-CS.
Value Range	0–7
Default Value	7

2.3.2 HTTP Client Settings

This screen allows you to change the HTTP client settings for the SIP-CS in order to access the HTTP server of your phone system and download configuration files.

The screenshot shows the Panasonic SIP CS KX-UDS124 web interface. The top navigation bar includes 'Status', 'Network', 'System', 'VoIP', 'Telephone', and 'Maintenance'. The 'Network' section is expanded, showing 'Basic Network Settings', 'HTTP Client Settings' (highlighted with a red box), 'HTTP Authentication', and 'Global Address Detection'. The 'HTTP Client Settings' page has two main sections: 'HTTP Client Settings' and 'Proxy Server Settings'. In the 'HTTP Client Settings' section, 'HTTP Version' is set to 'HTTP/1.0' (selected with a radio button) and 'HTTP User Agent' is 'Panasonic_{MODEL}/(fwver) {(mac)}'. In the 'Proxy Server Settings' section, 'Enable Proxy' is set to 'No', 'Proxy Server Address' is empty, and 'Proxy Server Port' is '8080'. At the bottom, there are 'All Save' and 'Cancel' buttons.

2.3.2.1 HTTP Client Settings

HTTP Version

Description	Selects which version of the HTTP protocol to use for HTTP communication.
Value Range	<ul style="list-style-type: none"> HTTP/1.0 HTTP/1.1 <p>Note</p> <ul style="list-style-type: none"> For this SIP-CS, it is strongly recommended that you select [HTTP/1.0]. However, if the HTTP server does not function well with HTTP/1.0, try changing the setting [HTTP/1.1].
Default Value	HTTP/1.0

HTTP User Agent

Description	Specifies the text string to send as the user agent in the header of HTTP requests.
--------------------	---

2.3.3 HTTP Authentication

Value Range	Max. 40 characters Note <ul style="list-style-type: none">• You cannot leave this field empty.• If "{mac}" is included in this field, it will be replaced with the SIP-CS's MAC address in lower-case.• If "{MAC}" is included in this field, it will be replaced with the SIP-CS's MAC address in upper-case.• If "{MODEL}" is included in this field, it will be replaced with the SIP-CS's model name.• If "{fwver}" is included in this field, it will be replaced with the firmware version of the SIP-CS.
Default Value	Panasonic_{MODEL}/{fwver} ({mac})

2.3.2.2 Proxy Server Settings

Enable Proxy

Description	Selects whether to use the proxy server.
Value Range	<ul style="list-style-type: none">• Yes• No
Default Value	No

Proxy Server Address

Description	Specifies the IP address or FQDN of the proxy server.
Value Range	Max. 127 characters Note <ul style="list-style-type: none">• You cannot leave this field empty if [Enable Proxy] is set to [Yes].
Default Value	Not stored.

Proxy Server Port

Description	Specifies the port number of the proxy server.
Value Range	1–65535
Default Value	8080

2.3.3 HTTP Authentication

This screen allows you to change the ID and the password used to authenticate the User account.

Note

- Although this setting is technically possible, you cannot log in to the Web user interface with the User account.

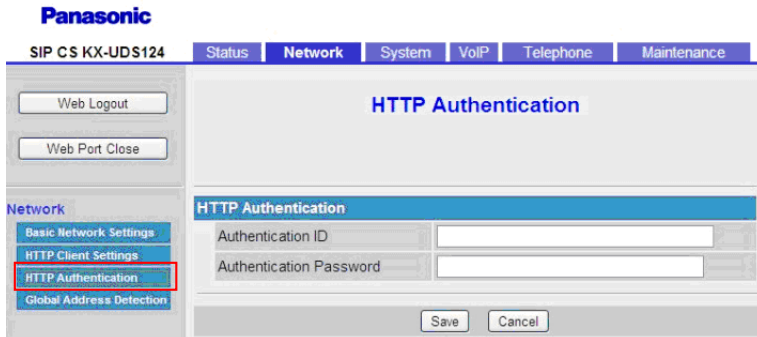

2.3.3.1 HTTP Authentication

Authentication ID

Description	Specifies the ID for the User account for Web user interface programming.
Value Range	Max. 127 characters
Default Value	Not stored.

Authentication Password

Description	Specifies the password for the User account for Web user interface programming.
Value Range	Max. 127 characters
Default Value	Not stored.

2.3.4 Global Address Detection

This screen allows you to configure the Global Address Detection feature and STUN server settings. The global IP address of the network the SIP-CS is connected to will be detected periodically. If the global IP address has changed, the new address will be registered to the SIP server.

2.3.4 Global Address Detection

Note

- If the SIP-CS is connected directly to the Internet, or the network global address is static (i.e., does not change), you do not need to configure Global Address Detection.

The screenshot shows the Panasonic SIP CS KX-UDS124 web interface. The top navigation bar includes 'Status', 'Network', 'System', 'VoIP', 'Telephone', and 'Maintenance'. The 'Network' tab is active. On the left sidebar, 'Global Address Detection' is highlighted. The main content area is titled 'Global Address Detection' and contains the following configuration options:

- Detection Method:** Radio buttons for STUN (selected) and SIP.
- Detection Interval:** A text input field with '0' and a label 'second(s) [10-65535, 0: Disable]'. A dropdown menu is visible next to the input field.
- STUN Server:** A section with two fields: 'STUN Server Address' (empty) and 'STUN Server Port' (3478) with a label '[1-65535]'.

At the bottom of the configuration area are 'All Save' and 'Cancel' buttons.

2.3.4.1 Global Address Detection

Detection Method

Description	Selects the method to use for detecting the global IP address.
Value Range	<ul style="list-style-type: none">• STUN• SIP
Default Value	STUN

Detection Interval

Description	Specifies the interval, in seconds, to wait between attempts to detect the global IP address.
Value Range	0, 10–65535 (0: Disable)
Default Value	0

2.3.4.2 STUN Server

STUN Server Address

Description	Specifies the IP address or FQDN of the STUN server.
Value Range	Max. 127 characters
Default Value	Not stored.

STUN Server Port

Description	Specifies the port number of the STUN server.
Value Range	1–65535
Default Value	3478

2.4 System

This section provides detailed descriptions about all the settings classified under the **[System]** tab.

2.4.1 Web Language

This screen allows you to select the language used for the Web user interface.

Note

- Although this setting is technically possible, the language used for the Web user interface for the Administrator account is always English.

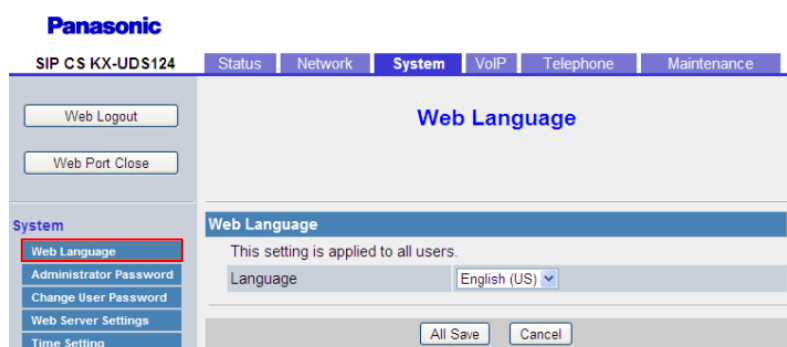

2.4.1.1 Web Language

Language

Description	Selects the language used for the Web user interface.
Value Range	<ul style="list-style-type: none"> English (US) English (UK) Deutsch Français Español Italiano Portugués Русский
Default Value	English (US)

2.4.2 Administrator Password

This screen allows you to change the password used to authenticate the Administrator account when logging in to the Web user interface.

Note

- For security reasons, the characters entered for the password are masked by special characters, which differ depending on the Web browser.
- After you change the administrator password, the next time you access the Web user interface, the authentication dialog box appears. Two consecutive login failures will result in an error ("401 Unauthorized"). This restriction only applies the first time you attempt to log in after changing the password. In all other circumstances, an error occurs after 3 unsuccessful login attempts.

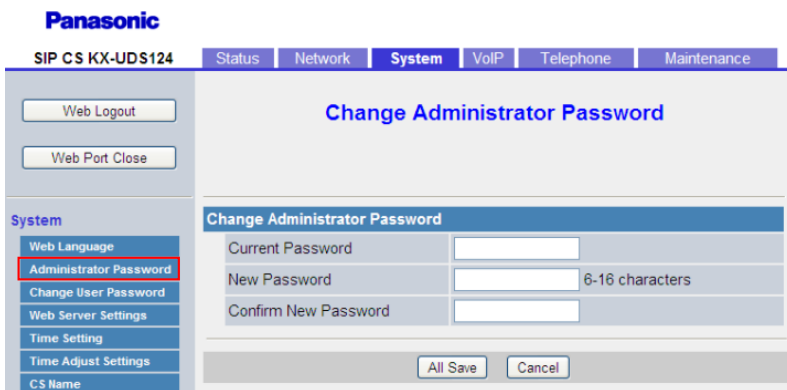

2.4.2.1 Change Administrator Password

Current Password

Description	Specifies the current password to use to authenticate the Administrator account when logging in to the Web user interface.
Value Range	6–16 characters (except ", &, ', :, <, >, and space)
Default Value	adminpass

New Password

Description	Specifies the new password to use to authenticate the Administrator account when logging in to the Web user interface.
Value Range	6–16 characters (except ", &, ', :, <, >, and space)
Default Value	Not stored.

Confirm New Password

Description	Specifies the same password that you entered in [New Password] for confirmation.
--------------------	---

Value Range	6–16 characters (except ", &, ', :, <, >, and space) Note <ul style="list-style-type: none"> This value must be the same as the value entered in [New Password].
Default Value	Not stored.

2.4.3 Change User Password

This screen allows you to view the name and phone number of each S-PS. Click a numbered tab to view this screen for a particular S-PS.

Note

- Although this setting is technically possible, you cannot log in to the Web user interface with the User account.

The screenshot shows the Panasonic SIP CS KX-UDS124 web interface. The top navigation bar includes 'Status', 'Network', 'System', 'VoIP', 'Telephone', and 'Maintenance'. The 'System' menu on the left is expanded, showing options like 'Web Language', 'Administrator Password', 'Change User Password' (highlighted), 'Web Server Settings', 'Time Setting', 'Time Adjust Settings', 'CS Name', 'Air Settings', 'CS Management', 'Tree Survey', 'CS Monitor', 'PS Registration', and 'PS Settings'. The main content area is titled 'Change User Password' and features a table with the following data:

No.	PS Name	Phone Number	Select Button
1	efgh	1001	Change User Password
2			Change User Password
3			Change User Password
4			Change User Password
5			Change User Password
6			Change User Password
7			Change User Password
8			Change User Password
9			Change User Password
10			Change User Password

2.4.3.1 Change User Password

No.

Description	Indicates the table number of the S-PS that is registered to the SIP-CS (reference only).
Value Range	1–255
Default Value	Not applicable.

PS Name

Description	Indicates the currently assigned name of the S-PS (reference only).
--------------------	---

2.4.3 Change User Password

Value Range	Max. 20 characters
Default Value	Not applicable.

Phone Number

Description	Indicates the currently assigned phone numbers (reference only). Note <ul style="list-style-type: none">Indicates both lines if the SIP-CS is connected in general SIP Server.
Value Range	Max. 32 digits
Default Value	Not applicable.

2.4.3.2 Changing User Password

This screen will be displayed by clicking **[Change User Password]** under **[Select Button]** on the **[Change User Password]** screen. You can change the password used to authenticate the User account on this screen.

Note

- Although this setting is technically possible, you cannot log in to the Web user interface with the User account.

2.4.3.3 PS Name

PS Name

Description	Indicates the currently assigned name of the S-PS (reference only).
Value Range	Max. 20 characters
Default Value	Not applicable.

2.4.3.4 Change User Password

New Password

Description	Specifies the new password to use to authenticate the User account for Web user interface programming.
Value Range	6–16 characters (except ", &, ', :, <, >, and space)
Default Value	Not stored.

Confirm New Password

Description	Specifies the same password that you entered in [New Password] for confirmation.
Value Range	6–16 characters (except ", &, ', :, <, >, and space) Note <ul style="list-style-type: none"> This value must be the same as the value entered in [New Password].
Default Value	Not stored.

2.4.4 Web Server Settings

This screen allows you to change the Web server settings.

The screenshot shows the Panasonic SIP CS KX-UDS124 web interface. At the top, there are navigation tabs: Status, Network, System (selected), VoIP, Telephone, and Maintenance. Below the tabs, there are buttons for 'Web Logout' and 'Web Port Close'. The main content area is titled 'Web Server Settings'. On the left, there is a 'System' menu with options: Web Language, Administrator Password, Change User Password, Web Server Settings (highlighted with a red box), and Time Setting. The main settings area contains two rows: 'Web Server Port' with a text input containing '80' and a range indicator '[80, 1024-49151]', and 'Port Close Timer' with a text input containing '30' and a unit indicator 'minute(s) [1-1440]'. At the bottom of the settings area, there are 'All Save' and 'Cancel' buttons.

2.4.4.1 Web Server Settings

Web Server Port

Description	Specifies the port number used by the Web server.
Value Range	80, 1024–49151 Note <ul style="list-style-type: none"> You cannot specify here the same port number as any of the port numbers specified for the individual lines in [Source Port] in 2.5.3.4 SIP Source Port.
Default Value	80

2.4.5 Time Setting

Port Close Timer

Description	Specifies the length of time, in minutes, to keep the Web port open when there has been no communication between the SIP-CS and the PC. If the specified length of time elapses without any communication, the Web port closes automatically. Communication is detected when you click a tab, menu item, the [Save] button, or by reloading the application or pressing the F5 key.
Value Range	1–1440
Default Value	30

2.4.5 Time Setting

This screen allows you to change the time settings.

The screenshot shows the Panasonic SIP CS KX-UDS124 web interface. The top navigation bar includes 'Status', 'Network', 'System' (selected), 'VoIP', 'Telephone', and 'Maintenance'. The main content area is titled 'Time Setting'. On the left, there is a 'System' menu with options: 'Web Language', 'Administrator Password', 'Change User Password', 'Web Server Settings', and 'Time Setting' (highlighted with a red box). The 'Time Setting' section contains two input fields: 'Date' with the value '1 / 31 / 2012' and a placeholder '[mm / dd / yyyy]', and 'Time' with the value '00 : 00' and a placeholder '[hh : mm]'. At the bottom of the section are 'All Save' and 'Cancel' buttons.

2.4.5.1 Time Setting

Date

Description	Specifies the month (1–2 digits), date (1–2 digits), and year (4 digits).
Value Range	Month: 1–12, Date: 1–31, Year: 2000–2099
Default Value	1/31/2012

Time

Description	Specifies the hour (1–2 digits) and minute (1–2 digits).
Value Range	00:00–23:59
Default Value	00:00

2.4.6 Time Adjust Settings

This screen allows you to enable automatic clock adjustment using an NTP server and configure the settings for DST (Daylight Saving Time), also known as Summer Time.

2.4.6.1 Synchronization

Enable Synchronization by NTP

Description	Selects whether to enable the SIP-CS to automatically adjust its clock according to the time information provided by an NTP server.
Value Range	<ul style="list-style-type: none"> • Yes • No <p>Note</p> <ul style="list-style-type: none"> • Even if you select [Yes], this feature will not function properly if the NTP server address setting is invalid.
Default Value	Yes

Synchronization Interval

Description	Specifies the interval, in seconds, between synchronizations with the NTP server.
Value Range	10–86400

2.4.6 Time Adjust Settings

Default Value	43200
---------------	-------

2.4.6.2 Time Server

NTP Server Address

Description	Specifies the IP address or FQDN of the NTP server.
Value Range	Max. 127 characters
Default Value	Not stored.

2.4.6.3 Time Zone

Time Zone

Description	Selects your time zone.
Value Range	GMT -12:00–GMT +13:00
Default Value	GMT

2.4.6.4 Daylight Saving Time (Summer Time)

Enable DST (Enable Summer Time)

Description	Selects whether to enable DST (Summer Time).
Value Range	<ul style="list-style-type: none">• Yes• No
Default Value	No

DST Offset (Summer Time Offset)

Description	Specifies the amount of time, in minutes, to change the time when [Enable DST (Enable Summer Time)] is set to [Yes] .
Value Range	0–720
Default Value	60

2.4.6.5 Start Day and Time of DST (Start Day and Time of Summer Time)

Month

Description	Selects the month in which DST (Summer Time) starts.
-------------	--

Value Range	<ul style="list-style-type: none"> • January • February • March • April • May • June • July • August • September • October • November • December
Default Value	March

Day of Week

Using the 2 following settings, specify on which day of the selected month DST (Summer Time) starts. For example, to specify the second Sunday, select **[Second]** and **[Sunday]**.

Description	Selects the number of the week on which DST (Summer Time) starts.
Value Range	<ul style="list-style-type: none"> • First • Second • Third • Fourth • Last
Default Value	Second

Description	Selects the day of the week on which DST (Summer Time) starts.
Value Range	<ul style="list-style-type: none"> • Sunday • Monday • Tuesday • Wednesday • Thursday • Friday • Saturday
Default Value	Sunday

Time

Description	Specifies the start time of DST (Summer Time) in minutes after 12:00 AM.
Value Range	0–1439
Default Value	120

2.4.6.6 End Day and Time of DST (End Day and Time of Summer Time) Month

Description	Selects the month in which DST (Summer Time) ends.
Value Range	<ul style="list-style-type: none"> • January • February • March • April • May • June • July • August • September • October • November • December
Default Value	October

Day of Week

Using the 2 following settings, specify on which day of the selected month DST (Summer Time) ends. For example, to specify the second Sunday, select **[Second]** and **[Sunday]**.

Description	Selects the number of the week on which DST (Summer Time) ends.
Value Range	<ul style="list-style-type: none"> • First • Second • Third • Fourth • Last
Default Value	Second

Description	Selects the day of the week on which DST (Summer Time) ends.
Value Range	<ul style="list-style-type: none"> • Sunday • Monday • Tuesday • Wednesday • Thursday • Friday • Saturday
Default Value	Sunday

Time

Description	Specifies the end time of DST (Summer Time) in minutes after 12:00 AM.
Value Range	0–1439
Default Value	120

2.4.7 CS Name

This screen allows you to specify the name of the SIP-CS.

The screenshot shows the Panasonic SIP CS KX-UDS124 web interface. The 'System' menu is open, and 'CS Name' is selected. The main area shows a 'Name' input field and 'Save' and 'Cancel' buttons.

2.4.7.1 CS Name

Name

Description	Specifies the name of the SIP-CS.
Value Range	Max. 20 characters
Default Value	Not stored.

2.4.8 Air Settings

This screen allows you to change air synchronization settings.

2.4.8 Air Settings

Note

- When you change the settings on this screen and click **[Save]**, after the message "Complete" has been displayed, the SIP-CS will restart automatically with the new settings applied.

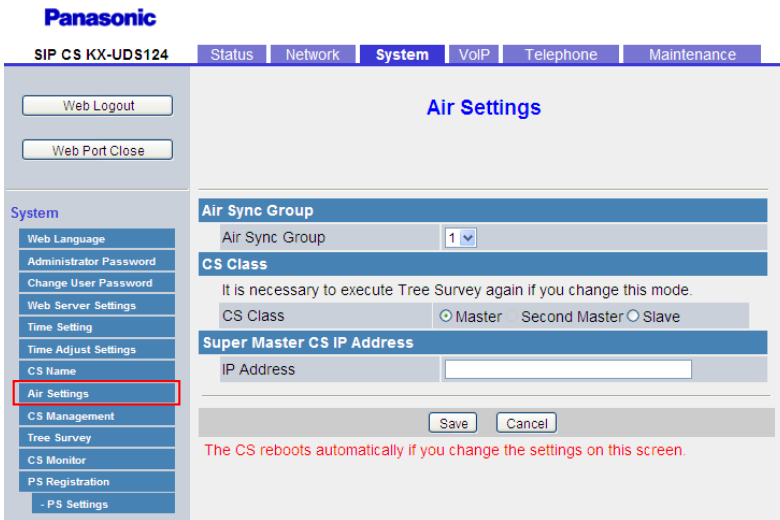

Panasonic
SIP CS KX-UDS124

Status | Network | **System** | VoIP | Telephone | Maintenance

Web Logout
Web Port Close

Air Settings

System

- Web Language
- Administrator Password
- Change User Password
- Web Server Settings
- Time Setting
- Time Adjust Settings
- CS Name
- Air Settings**
- CS Management
- Tree Survey
- CS Monitor
- PS Registration
- PS Settings

Air Sync Group
Air Sync Group: 1

CS Class
It is necessary to execute Tree Survey again if you change this mode.
CS Class: Master Second Master Slave

Super Master CS IP Address
IP Address:

Save Cancel

The CS reboots automatically if you change the settings on this screen.

2.4.8.1 Air Sync Group

Air Sync Group

Description	Selects the number of the Air Sync Group that the SIP-CS belongs to. Note <ul style="list-style-type: none"> This setting is effective when the class of the SIP-CS is "Master".
Value Range	1–8
Default Value	1

2.4.8.2 CS Class

CS Class

Description	Selects the classification of the SIP-CS.
Value Range	<ul style="list-style-type: none"> Master Second Master Slave Note <ul style="list-style-type: none"> [Second Master] is for reference only and cannot be selected.
Default Value	Slave

2.4.8.3 Super Master CS IP Address

IP Address

Description	Specifies the IP address of the Super Master CS to which the SIP-CS is connected. Note <ul style="list-style-type: none"> The "Super Master CS" refers to the Master CS of Air Sync Group 1. This setting is effective when the class of the SIP-CS is "Master".
Value Range	IP address
Default Value	Not stored.

2.4.9 CS Management

This screen allows you to manage the SIP-CS registration to a particular Air Sync Group.

After selecting the target Air Sync Group, you can change the SIP-CS registration status as follows:

- Click [**Start CS Registration**] to register the SIP-CS to the selected Air Sync Group.
- Click [**Stop CS Registration**] to stop the proceeding SIP-CS registration.
- If you want to delete the registered SIP-CS from the selected Air Sync Group, check the check box of the target SIP-CS in [**CS Registered List**], and then click [**Delete CS Registration**].

Note

- You cannot delete a SIP-CS that is registered as a "Master CS".

Panasonic
SIP CS KX-UDS124

Status | Network | **System** | VoIP | Telephone | Maintenance

Web Logout
Web Port Close

CS Management

System

- Web Language
- Administrator Password
- Change User Password
- Web Server Settings
- Time Setting
- Time Adjust Settings
- CS Name
- Air Settings
- CS Management**
- Tree Survey
- CS Monitor
- PS Registration
- PS Settings

CS Registration

Air Sync Group: 1
Number of CS: 30

Start CS Registration
Stop CS Registration

CS Registration Start / Stop

Only CS that has a check in the check box can be deleted.

CS Registration Delete: Delete CS Registration

CS Registered List

All

No.	Index	CS Name	CS ID	MAC Address	IP Address	CS Class	Remote Login
1	1	01973103D0		00.80.F0.E9.74.40	192.168.0.103	Master	
2	2	0018E58900		00.80.F0.AC.67.44	192.168.0.142	Slave	Login
3							
4							
5							
6							

2.4.9.1 CS Registration

Air Sync Group

Description	Selects the number of the Air Sync Group that contains the SIP-CS to be registered, stopped, or deleted.
Value Range	1–8
Default Value	1

Number of CS

Description	Selects the maximum number of SIP-CS registrations in your environment.
Value Range	1–32
Default Value	31

2.4.9.2 CS Registered List

Note

- In order to delete the registered SIP-CS from the selected Air Sync Group, you must check the check box of the target SIP-CS first. If you want to delete all the registered SIP-CS, check the check box for **[All]**.
- You can display the **[CS Name]** screen of the **[System]** tab by clicking **[Login]** under **[Remote Login]** for each SIP-CS.
When logged in remotely, if you click **[Web Logout]** on the screen being remotely accessed, the Web user interface of the local SIP-CS may return to the login screen. In this case, enter the ID and password to log in again.

No.

Description	Indicates the number of the SIP-CS (reference only).
Value Range	1–128
Default Value	Not applicable.

Index

Description	Indicates the index of the SIP-CS that is registered to the Super Master CS (reference only).
Value Range	1–128
Default Value	Not applicable.

CS Name

Description	Indicates the name of the SIP-CS that is registered to the Super Master CS (reference only).
Value Range	Max. 20 characters
Default Value	Not applicable.

CS ID

Description	Indicates the ID of the SIP-CS that is registered to the Super Master CS (reference only).
Value Range	10 characters
Default Value	Not applicable.

MAC Address

Description	Indicates the MAC address of the SIP-CS that is registered to the Super Master CS (reference only).
Value Range	Not applicable.
Default Value	Not applicable.

IP Address

Description	Indicates the IP address of the SIP-CS that is registered to the Super Master CS (reference only).
Value Range	IP address
Default Value	Not applicable.

CS Class

Description	Indicates the class of the SIP-CS that is registered to the Super Master CS (reference only).
Value Range	<ul style="list-style-type: none"> • Master • 2nd Master • Slave
Default Value	Not applicable.

2.4.10 Tree Survey

This screen allows you to change settings for Tree Survey.

The screenshot shows the Panasonic SIP CS KX-UDS124 web interface. The top navigation bar includes 'Status', 'Network', 'System', 'VoIP', 'Telephone', and 'Maintenance'. The 'System' tab is selected. The main content area is titled 'Tree Survey' and contains the following elements:

- Air Sync Group:** A dropdown menu set to '1'.
- Tree Survey:** A 'Start Tree Survey' button.
- Result Application:** 'Apply' and 'Cancel' buttons.
- Survey List:** A table with columns: Index, CS Name (MAC Address), CS Class, Status, Primary CS Index, Secondary CS Index, and Level.

Index	CS Name MAC Address	CS Class	Status	Primary CS Index	Secondary CS Index	Level
1	0080F0E975F9	Master	INS	-	-	-
2	0080F0D755E7	Slave	-	1		1
4	0080F0E97605	2nd Master	-	1		1

2.4.10.1 Tree Survey

Air Sync Group

Description	Selects the number of the Air Sync Group to be configured.
Value Range	1–8
Default Value	1

This screen allows you to change the Tree Survey settings for a particular Air Sync Group.

After selecting the target Air Sync Group, you can change the Tree Survey settings as follows:

- Click **[Start Tree Survey]** to start the Tree Survey for all SIP-CSs in the Air Sync Group. After the Tree Survey has completed, click **[Tree Image]**. A connection diagram of the SIP-CSs will be displayed.
- Click **[Apply]** to apply the Tree Survey results to all SIP-CSs in the Air Sync Group.
- Click **[Cancel]** to cancel the Tree Survey results for all SIP-CSs in the Air Sync Group.

Note

- If you press **[Start Tree Survey]** or **[Apply]** while an S-PS is on a call, the call will be disconnected.

2.4.10.2 Survey List

Index

Description	Indicates the index of the SIP-CS that is registered to the Super Master CS (reference only).
Value Range	1–128
Default Value	Not applicable.

CS Name

Description	Indicates the name of the SIP-CS that is registered to the Super Master CS (reference only).
Value Range	Max. 20 characters
Default Value	Not applicable.

MAC Address

Description	Indicates the MAC address of the SIP-CS that is registered to the Super Master CS (reference only).
Value Range	Not applicable.
Default Value	Not applicable.

CS Class

Description	Selects the class of the SIP-CS that is registered to the Super Master CS.
Value Range	<ul style="list-style-type: none"> • Master (reference only) • 2nd Master • Slave
Default Value	Not stored.

Status

Description	Indicates the service status of the SIP-CS that is registered to the Super Master CS (reference only).
Value Range	<ul style="list-style-type: none"> • INS • - (not available)
Default Value	Not applicable.

Primary CS Index

Description	Specifies the primary sync index of the SIP-CS that is registered to the Super Master CS.
Value Range	1–128, - Note • "-" means unused.
Default Value	Not stored.

Secondary CS Index

Description	Specifies the secondary sync index of the SIP-CS that is registered to the Super Master CS.
Value Range	1–128, - Note • "-" means unused.
Default Value	Not stored.

Level

Description	Indicates the level of the SIP-CS that is registered to the Super Master CS (reference only). Note • The level refers to the level in the tree structure.
Value Range	1–8
Default Value	Not applicable.

2.4.11 CS Monitor

This screen allows you to view information such as the current air synchronization status of each SIP-CS in a particular Air Sync Group.

After selecting the target Air Sync Group, you can monitor the SIP-CS status as follows:

- Click **[Monitor Start]** to start monitoring.
- Click **[Monitor Stop]** to stop the proceeding monitoring.

- After monitoring has completed, click **[Tree Image]**. A connection diagram of the SIP-CSs will be displayed.

The screenshot shows the Panasonic SIP CS KX-UDS124 web interface. The top navigation bar includes 'Status', 'Network', 'System', 'VoIP', 'Telephone', and 'Maintenance'. The 'System' menu is expanded, showing options like 'Web Language', 'Administrator Password', 'Change User Password', 'Web Server Settings', 'Time Setting', 'Time Adjust Settings', 'CS Name', 'Air Settings', 'CS Management', 'Tree Survey', 'CS Monitor' (highlighted with a red box), 'PS Registration', and '- PS Settings'. The main content area is titled 'CS Monitor' and features a 'Monitoring ...' status indicator. There are buttons for 'Tree Image', 'Monitor Start', and 'Monitor Stop'. Below this is a table for 'CS Monitor' with a dropdown for 'Air Sync Group' set to '1'. The table has columns: Index, RSSI [dBm], Error Rate [%], Wired LAN, CS Name MAC Address, Status, CS Type, CS RPT, and CS Index.

2.4.11.1 CS Monitor

Air Sync Group

Description	Selects the number of the Air Sync Group whose SIP-CSs you want to monitor.
Value Range	1–8
Default Value	1

Index

Description	Indicates the index of the SIP-CS that is currently connected (reference only).
Value Range	1–128
Default Value	Not applicable.

RSSI

Description	Indicates the RSSI of the SIP-CS that is currently connected (reference only).
Value Range	-, -1 – -100 Note <ul style="list-style-type: none"> The RSSI is indicated by the color, as follows: <ul style="list-style-type: none"> Green: -80 dBm or greater Yellow: Less than -80 dBm Red: Out of synchronization ("-")

2.4.11 CS Monitor

Default Value	Not applicable.
----------------------	-----------------

Error Rate

Description	Indicates the Error Rate of the SIP-CS that is currently connected (reference only).
Value Range	-, 0 – 100 (%) Note <ul style="list-style-type: none">• The error rate is indicated by the color, as follows:<ul style="list-style-type: none">– Green: Less than 10%– Yellow: 10% or greater– Red: Out of synchronization ("-")
Default Value	Not applicable.

Wired LAN

Description	Indicates the wired LAN status of the SIP-CS that is currently connected (reference only).
Value Range	<ul style="list-style-type: none">• OK• NG Note <ul style="list-style-type: none">• The wired LAN status is indicated by the color, as follows:<ul style="list-style-type: none">– Green: OK– Red: NG
Default Value	Not applicable.

CS Name

Description	Indicates the name of the SIP-CS that is currently connected (reference only).
Value Range	Max. 20 characters
Default Value	Not applicable.

MAC Address

Description	Indicates the MAC address of the SIP-CS that is currently connected (reference only).
Value Range	Not applicable.
Default Value	Not applicable.

Status

Description	Indicates the service status of the SIP-CS that is currently connected (reference only).
Value Range	<ul style="list-style-type: none"> • INS • - (not available)
Default Value	Not applicable.

Current Sync CS (CS Type)

Description	Indicates the type of the SIP-CS that is currently connected (reference only).
Value Range	<ul style="list-style-type: none"> • Primary • Secondary • Other <p>Note</p> <ul style="list-style-type: none"> • [Other] is displayed when the SIP-CS cannot be synchronized to the Primary CS or Secondary CS, but can be synchronized to another SIP-CS. In other words, synchronization to the Primary CS or Secondary CS is not available due to radio interference, the Primary/Secondary CS being turned off, etc., but synchronization to another SIP-CS is available.
Default Value	Not applicable.

Current Sync CS (CS RPT)

Description	Indicates whether a SIP-CS or a repeater is currently connected (reference only).
Value Range	CS
Default Value	CS (fixed)

Current Sync CS (CS Index)

Description	Indicates the index of the SIP-CS that is currently connected (reference only).
Value Range	1–128
Default Value	Not applicable.

2.4.12 PS Registration

This screen allows you to manage the registration of S-PSs to the SIP-CS. Click a numbered tab to view this screen for a particular S-PS.

2.4.12 PS Registration

Note

- The [SIP Settings - PS [Line x]] screen will be displayed by clicking [Linex SIP Setting] under [Select Button] (→ see 2.5.2 SIP Settings - PS).

Panasonic
SIP CS KX-UDS124 | Status | Network | **System** | VoIP | Telephone | Maintenance

Web Logout
Web Port Close

System

- Web Language
- Administrator Password
- Change User Password
- Web Server Settings
- Time Setting
- Time Adjust Settings
- CS Name
- Air Settings
- CS Management
- Tree Survey
- CS Monitor
- PS Registration**
- PS Settings

PS Registration

Please push the "Stop PS Registration" button to stop on the way after starting PS Registration.

Start PS Registration
Stop PS Registration

Please push the "Delete PS Registration" to delete registered PS.

PS Registration Delete
Delete PS Registration

1- 21- 41- 61- 81- 101- 121- 141- 161- 181- 201- 221- 241-

PS Name / Number				
No.	PS Name	Select Button	Phone Number	Wireless Status
1	test	Line1 SIP Setting	4261	Registered
		Line2 SIP Setting		
2	test2	Line1 SIP Setting	4262	Registered
		Line2 SIP Setting		

2.4.12.1 PS Registration

No.

Description	Indicates the table number of the S-PS that is registered to the SIP-CS (reference only).
Value Range	1–255
Default Value	Not applicable.

PS Name

Description	Specifies the name of the S-PS that is registered to the SIP-CS.
Value Range	Max. 20 characters
Default Value	Not stored.

Phone Number

Description	Indicates the currently assigned phone numbers (reference only).
Value Range	Max. 32 digits
Default Value	Not applicable.

Wireless Status

Description	Indicates the wireless status of the S-PS that is registered to the SIP-CS (reference only).
Value Range	<ul style="list-style-type: none"> • Registered • Un Registered
Default Value	Not applicable.

2.4.13 PS Registration - Start PS Registration

This screen will be displayed if **[Start PS Registration]** is clicked on the **[PS Registration]** screen. You can register the desired S-PSs to the SIP-CS as follows. To stop the preceding PS Registration, click **[Stop PS Registration]**.

1. Select the S-PSs to be registered in **[Available PS]**, and then click .
To select all available S-PSs, click . To deselect S-PS(s), click or .
2. Click **[Next]**.
A dialog box to confirm the saving of settings is displayed.
3. Click **[OK]**.

2.4.14 PS Registration - Delete PS Registration

This screen will be displayed if **[Delete PS Registration]** is clicked on the **[PS Registration]** screen. You can delete the desired S-PSs from the SIP-CS as follows.

1. Select the S-PSs to be unregistered in **[Available PS]**, and then click .
To select all available S-PSs, click . To deselect S-PS(s), click or .
2. Click **[Next]**.
A dialog box to confirm the saving of settings is displayed.
3. Click **[OK]**.

2.4.15 PS Registration - PS Settings

This screen allows you to set the PIN Code for S-PS registration.

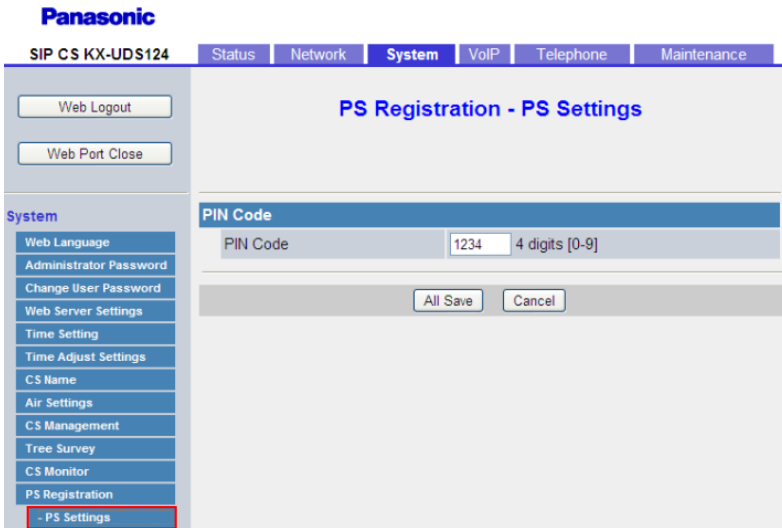

2.4.15.1 PIN Code

PIN Code

Description	Specifies the PIN (Personal Identification Number) used when registering the S-PS.
Value Range	Max. 4 digits
Default Value	1234

2.5 VoIP

This section provides detailed descriptions about all the settings classified under the **[VoIP]** tab.

2.5.1 SIP Settings

This screen allows you to change the SIP settings that are common to all lines.

Panasonic
SIP CS KX-UDS124

Status | Network | System | **VoIP** | Telephone | Maintenance

Web Logout
Web Port Close

SIP Settings

VoIP
SIP Settings
SIP Settings - PS
VoIP Settings

SIP Setting
SIP User Agent: Panasonic_(MODEL)/fwver) ((mac)

SIP Server
Registrar Server Address: 192.168.0.10
Registrar Server Port: 5060 [1-65535]
Proxy Server Address: 192.168.0.10
Proxy Server Port: 5060 [1-65535]
Presence Server Address:
Presence Server Port: 5060 [1-65535]

Outbound Proxy Server
Outbound Proxy Server Address:
Outbound Proxy Server Port: 5060 [1-65535]

SIP Service Domain
Service Domain:

DNS
Enable DNS SRV lookup: Yes No
SRV lookup Prefix for UDP: sip_udp
SRV lookup Prefix for TCP: sip_tcp

Transport Protocol for SIP
Transport Protocol: UDP TCP

Timer Settings
T1 Timer: 500 milliseconds
T2 Timer: 4 seconds
Timer B: 32000 milliseconds [250-64000]
Timer D: 5000 milliseconds [0, 250-64000]
Timer F: 32000 milliseconds [250-64000]
Timer H: 32000 milliseconds [250-64000]
Timer J: 5000 milliseconds [0, 250-64000]

Quality of Service (QoS)
SIP Packet QoS (DSCP): 0 [0-63]

SIP extensions
Supports 100rel (RFC 3262): Yes No
Supports Session Timer (RFC 4028): 0 seconds [60-65535, 0: Disable]

Security
Enable SSAF (SIP Source Address Filter): Yes No

All Save Cancel

2.5.1.1 SIP Setting

SIP User Agent

Description	Specifies the text string to send as the user agent in the headers of SIP messages.
--------------------	---

2.5.1 SIP Settings

Value Range	Max. 40 characters Note <ul style="list-style-type: none">• You cannot leave this field empty.• If "{mac}" is included in this field, it will be replaced with the SIP-CS's MAC address in lower-case.• If "{MAC}" is included in this field, it will be replaced with the SIP-CS's MAC address in upper-case.• If "{MODEL}" is included in this field, it will be replaced with the SIP-CS's model name.• If "{fwver}" is included in this field, it will be replaced with the firmware version of the SIP-CS.
Default Value	Panasonic_{MODEL}/{fwver} ({mac})

2.5.1.2 SIP Server

Registrar Server Address

Description	Specifies the IP address or FQDN of the SIP registrar server.
Value Range	Max. 127 characters
Default Value	Not stored.

Registrar Server Port

Description	Specifies the port number to use for communication with the SIP registrar server.
Value Range	1–65535
Default Value	5060

Proxy Server Address

Description	Specifies the IP address or FQDN of the SIP proxy server.
Value Range	Max. 127 characters
Default Value	Not stored.

Proxy Server Port

Description	Specifies the port number to use for communication with the SIP proxy server.
Value Range	1–65535
Default Value	5060

Presence Server Address

Description	Specifies the IP address or FQDN of the SIP presence server.
Value Range	Max. 127 characters
Default Value	Not stored.

Presence Server Port

Description	Specifies the port number to use for communication with the SIP presence server.
Value Range	1–65535
Default Value	5060

2.5.1.3 Outbound Proxy Server

Outbound Proxy Server Address

Description	Specifies the IP address or FQDN of the SIP outbound proxy server.
Value Range	Max. 127 characters
Default Value	Not stored.

Outbound Proxy Server Port

Description	Specifies the port number to use for communication with the SIP outbound proxy server.
Value Range	1–65535
Default Value	5060

2.5.1.4 SIP Service Domain

Service Domain

Description	Specifies the domain name provided by your dealer. The domain name is the part of the SIP URI that comes after the "@" symbol.
Value Range	Max. 127 characters
Default Value	Not stored.

2.5.1.5 DNS

Enable DNS SRV lookup

Description	Selects whether to request the DNS server to translate domain names into IP addresses using the SRV record.
Value Range	<ul style="list-style-type: none"> • Yes • No <p>Note</p> <ul style="list-style-type: none"> • If you select [Yes], the SIP-CS will perform a DNS SRV lookup for a SIP registrar server, SIP proxy server, SIP outbound proxy server, or SIP presence server. If you select [No], the SIP-CS will not perform a DNS SRV lookup for a SIP registrar server, SIP proxy server, SIP outbound proxy server, or SIP presence server.
Default Value	Yes

SRV lookup Prefix for UDP

Description	Specifies a prefix to add to the domain name when performing a DNS SRV lookup using UDP. <p>Note</p> <ul style="list-style-type: none"> • This setting is available only when [Enable DNS SRV lookup] is set to [Yes].
Value Range	Max. 32 characters
Default Value	_sip._udp.

SRV lookup Prefix for TCP

Description	Specifies a prefix to add to the domain name when performing a DNS SRV lookup using TCP. <p>Note</p> <ul style="list-style-type: none"> • This setting is available only when [Enable DNS SRV lookup] is set to [Yes].
Value Range	Max. 32 characters
Default Value	_sip._tcp.

2.5.1.6 Transport Protocol of SIP

Transport Protocol

Description	Selects which transport layer protocol to use for sending SIP packets.
--------------------	--

Value Range	<ul style="list-style-type: none"> • UDP • TCP
Default Value	UDP

2.5.1.7 Timer Settings

T1 Timer

Description	Selects the default interval, in milliseconds, between transmissions of SIP messages. For details, refer to RFC 3261.
Value Range	<ul style="list-style-type: none"> • 250 • 500 • 1000 • 2000 • 4000
Default Value	500

T2 Timer

Description	Selects the maximum interval, in seconds, between transmissions of SIP messages. For details, refer to RFC 3261.
Value Range	<ul style="list-style-type: none"> • 2 • 4 • 8 • 16 • 32
Default Value	4

Timer B

Description	Specifies the value of SIP timer B (INVITE transaction timeout timer), in milliseconds. For details, refer to RFC 3261.
Value Range	250–64000
Default Value	32000

Timer D

Description	Specifies the value of SIP timer D (wait time for answer resending), in milliseconds. For details, refer to RFC 3261.
Value Range	0, 250–64000
Default Value	5000

Timer F

Description	Specifies the value of SIP timer F (non-INVITE transaction timeout timer), in milliseconds. For details, refer to RFC 3261.
Value Range	250–64000
Default Value	32000

Timer H

Description	Specifies the value of SIP timer H (wait time for ACK reception), in milliseconds. For details, refer to RFC 3261.
Value Range	250–64000
Default Value	32000

Timer J

Description	Specifies the value of SIP timer J (wait time for non-INVITE request resending), in milliseconds. For details, refer to RFC 3261.
Value Range	0, 250–64000
Default Value	5000

2.5.1.8 Quality of Service (QoS)

SIP Packet QoS (DSCP)

Description	Specifies the DSCP (Differentiated Services Code Point) level of DiffServ applied to SIP packets.
Value Range	0–63
Default Value	0

2.5.1.9 SIP extensions

Supports 100rel (RFC 3262)

Description	Selects whether to add the option tag 100rel to the "Supported" header of the INVITE message. For details, refer to RFC 3262.
--------------------	---

Value Range	<ul style="list-style-type: none"> • Yes • No <p>Note</p> <ul style="list-style-type: none"> • If you select [Yes], the Reliability of Provisional Responses function will be enabled. The option tag 100rel will be added to the "Supported" header of the INVITE message and to the "Require" header of the "1xx" provisional message. If you select [No], the option tag 100rel will not be used.
Default Value	No

Supports Session Timer (RFC 4028)

Description	Specifies the length of time, in seconds, that the SIP-CS waits before terminating SIP sessions when no reply to repeated requests is received. For details, refer to RFC 4028.
Value Range	0, 60–65535 (0: Disable)
Default Value	0

2.5.1.10 Security

Enable SSAF (SIP Source Address Filter)

Description	Selects whether to enable SSAF (SIP Source Address Filter) for the SIP servers (registrar server, proxy server, and presence server).
Value Range	<ul style="list-style-type: none"> • Yes • No <p>Note</p> <ul style="list-style-type: none"> • If you select [Yes], the SIP-CS receives SIP messages only from the source addresses stored in the SIP servers (registrar server, proxy server, and presence server), and not from other addresses. However, if [Outbound Proxy Server Address] in 2.5.1.3 Outbound Proxy Server is specified, the SIP-CS also receives SIP messages from the source address stored in the SIP outbound proxy server.
Default Value	No

2.5.2 SIP Settings - PS

This screen allows you to check the SIP settings of S-PSs.

2.5.2 SIP Settings - PS

Click a numbered tab to view this screen for a particular S-PS.

Panasonic
SIP CS KX-UDS124 | Status | Network | System | **VoIP** | Telephone | Maintenance

Web Logout
Web Port Close

SIP Settings - PS

1- 21- 41- 61- 81- 101- 121- 141- 161- 181- 201- 221- 241-

VoIP

SIP Settings
SIP Settings - PS
VoIP Settings

No.	PS Name	Line No.	Phone Number	Select Button
1	001	1	1100	Line1 SIP Setting
2		2		Line2 SIP Setting

2.5.2.1 SIP Settings

No.

Description	Indicates the table number of the S-PS that is registered to the SIP-CS (reference only).
Value Range	1–255
Default Value	Not applicable.

PS Name

Description	Indicates the currently assigned name of the S-PS (reference only).
Value Range	Max. 20 characters
Default Value	Not applicable.

Line No.

Description	Indicates the line number of the S-PS that is registered to the SIP-CS (reference only).
Value Range	Line 1–2
Default Value	Not applicable.

Phone Number

Description	Indicates the currently assigned phone numbers (reference only).
Value Range	Max. 32 digits
Default Value	Not applicable.

2.5.3 SIP Settings - PS [Line 1–2]

This screen will be displayed by clicking **[Linux SIP Setting]** under **[Select Button]** on the **[SIP Settings - PS]** screen. You can change the SIP settings for the specific line of the desired S-PS on this screen.

The screenshot displays the Panasonic SIP Settings - PS [Line 1] configuration page. The page title is 'SIP Settings - PS [Line 1]'. The navigation menu on the left includes 'Web Logout', 'Web Port Close', and 'VoIP' settings. The 'VoIP' section is expanded, showing 'SIP Settings - PS' as the selected option. The main configuration area includes the following fields:

- PS Name:** PS Name (001)
- Phone Number:** Phone Number (1100), SIP URI
- SIP Authentication:** Authentication ID (1100), Authentication Password (****)
- SIP Source Port:** Source Port (5061) [1024-49151]

Buttons for 'All Save' and 'Cancel' are located at the bottom of the form.

2.5.3.1 PS Name

PS Name

Description	Indicates the currently assigned name of the S-PS (reference only).
Value Range	Max. 20 characters
Default Value	Not applicable.

2.5.3.2 Phone Number

Phone Number

Description	Indicates the currently assigned phone numbers (reference only).
Value Range	Max. 32 digits
Default Value	Not stored.

SIP URI

Description	Specifies the unique ID used by the SIP registrar server, which consists of "sip:", a user part, the "@" symbol, and a host part, for example, "sip:user@example.com". Note <ul style="list-style-type: none"> When registering using a user ID that is not a phone number, you should use this setting. In a SIP URI, the user part ("user" in the example above) can contain up to 63 characters, and the host part ("example.com" in the example above) can contain up to 127 characters.
Value Range	Max. 195 characters
Default Value	Not stored.

2.5.3.3 SIP Authentication

Authentication ID

Description	Specifies the authentication ID of the S-PS that is registered to the SIP-CS.
Value Range	Max. 127 characters
Default Value	Not stored.

Authentication Password

Description	Specifies the authentication password of the S-PS that is registered to the SIP-CS.
Value Range	Max. 127 characters
Default Value	Not stored.

2.5.3.4 SIP Source Port

Source Port

Description	Specifies the source port number of the S-PS that is registered to the SIP-CS.
Value Range	1024–49151
Default Value	<ul style="list-style-type: none"> PS1 Line1: 5061 PS1 Line2: 5062 PS2 Line1: 5063... Note <ul style="list-style-type: none"> The default value increases by 1 for each line.

2.5.4 VoIP Settings

This screen allows you to change the VoIP settings that are common to all lines.

Panasonic

SIP CS KX-UDS124 Status Network System **VoIP** Telephone Maintenance

Web Logout Web Port Close

VoIP Settings

VoIP

- SIP Settings
- SIP Settings - PS
- VoIP Settings**

RTP Settings

RTP Packet Time: milliseconds

Minimum RTP Port Number: [1024-48750: Even Number Only]

Maximum RTP Port Number: [1424-49150: Even Number Only]

Telephone-event Payload Type: [96-127]

Quality of Service (QoS)

RTP Packet QoS (DSCP): [0-63]

Statistical Information

RTCP Enable: Yes No

RTCP Interval: seconds [5-65535]

Jitter Buffer

Maximum Delay: [3-50]

Minimum Delay: [1-2]

Initial Delay: [1-7]

DTMF

DTMF Type: Outband Inband

Call Hold

Supports RFC 2543 (c=0.0.0.0): Yes No

CODEC Preferences

G722	Enable	<input checked="" type="radio"/> Yes <input type="radio"/> No
	Priority	<input type="text" value="1"/> [1-255]
PCMA	Enable	<input checked="" type="radio"/> Yes <input type="radio"/> No
	Priority	<input type="text" value="1"/> [1-255]
G726-32	Enable	<input checked="" type="radio"/> Yes <input type="radio"/> No
	Priority	<input type="text" value="1"/> [1-255]
G729A	Enable	<input checked="" type="radio"/> Yes <input type="radio"/> No
	Priority	<input type="text" value="1"/> [1-255]
PCMU	Enable	<input checked="" type="radio"/> Yes <input type="radio"/> No
	Priority	<input type="text" value="1"/> [1-255]

All Save Cancel

2.5.4.1 RTP Settings

RTP Packet Time

Description	Selects the interval, in milliseconds, between transmissions of RTP packets.
Value Range	<ul style="list-style-type: none"> • 20 • 30 • 40
Default Value	20

Minimum RTP Port Number

Description	<p>Specifies the lowest port number that the SIP-CS will use for RTP packets.</p> <p>Note</p> <ul style="list-style-type: none"> The available channel number varies depending on the type of the SIP-CS being used.
Value Range	<p>1024–45150 (even number only)</p> <p>Note</p> <ul style="list-style-type: none"> The value for this setting must be less than or equal to "[Maximum RTP Port Number] - 4000". Changing this setting may affect the number of simultaneous calls that can be made. Therefore, when setting this parameter, be aware that the maximum number of necessary ports can be calculated as shown below: No. of lines × No. of channels × 2 × 1 (No. of terminals)
Default Value	16000

Maximum RTP Port Number

Description	<p>Specifies the highest port number that the SIP-CS will use for RTP packets.</p> <p>Note</p> <ul style="list-style-type: none"> The available channel number varies depending on the type of the SIP-CS being used.
Value Range	<p>5024–49150 (even number only)</p> <p>Note</p> <ul style="list-style-type: none"> The value for this setting must be greater than or equal to "[Minimum RTP Port Number] + 4000". Changing this setting may affect the number of simultaneous calls that can be made. Therefore, when setting this parameter, be aware that the maximum number of necessary ports can be calculated as shown below: No. of lines × No. of channels × 2 × 1 (No. of terminals)
Default Value	29000

Telephone-event Payload Type

Description	<p>Specifies the RFC 2833 payload type for DTMF tones.</p> <p>Note</p> <ul style="list-style-type: none"> This setting is available only when [DTMF Type] is set to [Outband].
Value Range	96–127

Default Value	101
---------------	-----

2.5.4.2 Quality of Service (QoS)

RTP Packet QoS (DSCP)

Description	Specifies the DSCP level of DiffServ applied to RTP packets.
Value Range	0–63
Default Value	0

2.5.4.3 Statistical Information

RTCP Enable

Description	Selects whether to enable or disable RTCP (Real-Time Transport Control Protocol). For details, refer to RFC 3550.
Value Range	<ul style="list-style-type: none"> • Yes • No
Default Value	No

RTCP Interval

Description	Specifies the interval, in seconds, between RTCP packets.
Value Range	5–65535
Default Value	5

2.5.4.4 Jitter Buffer

Maximum Delay

Description	Specifies the maximum delay, in 10-millisecond units, of the jitter buffer.
Value Range	3–50 (× 10 ms) Note <ul style="list-style-type: none"> • This setting is subject to the following conditions: <ul style="list-style-type: none"> – This value must be greater than [Initial Delay] – This value must be greater than [Minimum Delay] – [Initial Delay] must be greater than or equal to [Minimum Delay]
Default Value	20 (× 10 ms)

Minimum Delay

Description	Specifies the minimum delay, in 10-millisecond units, of the jitter buffer.
Value Range	1 or 2 (× 10 ms) Note <ul style="list-style-type: none"> • This setting is subject to the following conditions: <ul style="list-style-type: none"> – This value must be less than or equal to [Initial Delay] – This value must be less than [Maximum Delay] – [Maximum Delay] must be greater than [Initial Delay]
Default Value	2 (× 10 ms)

Initial Delay

Description	Specifies the initial delay, in 10-millisecond units, of the jitter buffer.
Value Range	1–7 (× 10 ms) Note <ul style="list-style-type: none"> • This setting is subject to the following conditions: <ul style="list-style-type: none"> – This value must be greater than or equal to [Minimum Delay] – This value must be less than [Maximum Delay]
Default Value	2 (× 10 ms)

2.5.4.5 DTMF

DTMF Type

Description	Selects the method for transmitting DTMF (Dual Tone Multi-Frequency) tones.
Value Range	<ul style="list-style-type: none"> • Outband • Inband Note <ul style="list-style-type: none"> • If you select [Outband], DTMF tones will be sent through SDP (Session Description Protocol), compliant with RFC 2833. If you select [Inband], DTMF tones will be encoded in the RTP stream.
Default Value	Outband

2.5.4.6 Call Hold

Supports RFC 2543 (c=0.0.0.0)

Description	Selects whether to enable the RFC 2543 Call Hold feature on this line.
--------------------	--

Value Range	<ul style="list-style-type: none"> • Yes • No <p>Note</p> <ul style="list-style-type: none"> • If you select [Yes], the "c=0.0.0.0" syntax will be set in SDP when sending a re-INVITE message to hold the call. If you select [No], the "c=x.x.x.x" syntax will be set in SDP.
Default Value	Yes

2.5.4.7 CODEC Preferences

G722 (Enable)

Description	Selects whether to enable the G.722 codec for voice data transmission.
Value Range	<ul style="list-style-type: none"> • Yes • No
Default Value	Yes

G722 (Priority)

Description	Specifies the numerical order usage priority for the G.722 codec.
Value Range	1–255
Default Value	1

PCMA (Enable)

Description	Selects whether to enable the PCMA codec for voice data transmission.
Value Range	<ul style="list-style-type: none"> • Yes • No
Default Value	Yes

PCMA (Priority)

Description	Specifies the numerical order usage priority for the PCMA codec.
Value Range	1–255
Default Value	1

G726–32 (Enable)

Description	Selects whether to enable the G.726-32 codec for voice data transmission.
Value Range	<ul style="list-style-type: none">• Yes• No
Default Value	Yes

G726–32 (Priority)

Description	Specifies the numerical order usage priority for the G.726-32 codec.
Value Range	1–255
Default Value	1

G729A (Enable)

Description	Selects whether to enable the G.729A codec for voice data transmission.
Value Range	<ul style="list-style-type: none">• Yes• No
Default Value	Yes

G729A (Priority)

Description	Specifies the numerical order usage priority for the G.729A codec.
Value Range	1–255
Default Value	1

PCMU (Enable)

Description	Selects whether to enable the PCMU codec for voice data transmission.
Value Range	<ul style="list-style-type: none">• Yes• No
Default Value	Yes

PCMU (Priority)

Description	Specifies the numerical order usage priority for the PCMU codec.
Value Range	1–255

Default Value

1

2.6 Telephone

This section provides detailed descriptions about all the settings classified under the **[Telephone]** tab.

2.6.1 Call Control - Common

This screen allows you to configure various call features that are common to all lines. Click the **[Common]** tab to view this screen.

Panasonic

SIP CS KX-UDS124 Status Network System VoIP **Telephone** Maintenance

Web Logout

Web Port Close

Telephone

- Call Control
- Button Settings
- Tone Settings
- Telephone Settings
- Import Phonebook
- Export Phonebook

Call Control

Common 1 21 41 61 81 101 121 141 161 181 201 221 241

Call Control

Send SUBSCRIBE to Voice Mail Server Yes No

Conference Server URI

Inter-digit Timeout 5 seconds

Timer for Dial Plan 5 seconds

International Call Prefix

Country Calling Code

National Access Code

Flash/Recall Button Terminate Flash Hook

Flash Hook Event Signal flashhook

Call Rejection Phone Numbers

1.	<input type="text"/>	2.	<input type="text"/>
3.	<input type="text"/>	4.	<input type="text"/>
5.	<input type="text"/>	6.	<input type="text"/>
7.	<input type="text"/>	8.	<input type="text"/>
9.	<input type="text"/>	10.	<input type="text"/>
11.	<input type="text"/>	12.	<input type="text"/>
13.	<input type="text"/>	14.	<input type="text"/>
15.	<input type="text"/>	16.	<input type="text"/>
17.	<input type="text"/>	18.	<input type="text"/>
19.	<input type="text"/>	20.	<input type="text"/>
21.	<input type="text"/>	22.	<input type="text"/>
23.	<input type="text"/>	24.	<input type="text"/>
25.	<input type="text"/>	26.	<input type="text"/>
27.	<input type="text"/>	28.	<input type="text"/>
29.	<input type="text"/>	30.	<input type="text"/>

All Save Cancel

2.6.1.1 Call Control

Send SUBSCRIBE to Voice Mail Server

Description	Selects whether to send the SUBSCRIBE request to a voice mail server. Note <ul style="list-style-type: none"> Your phone system must support voice mail.
Value Range	<ul style="list-style-type: none"> Yes No
Default Value	No

Conference Server URI

Description	Specifies the URI for a conference server, which consists of "sip:", a user part, the "@" symbol, and a host part, for example, "sip:conference@example.com". Note <ul style="list-style-type: none"> In a SIP URI, the user part ("conference" in the example above) can contain up to 63 characters, and the host part ("example.com" in the example above) can contain up to 127 characters. Availability depends on your phone system.
Value Range	Max. 195 characters (except ", &, ', :, ;, <, >, and space)
Default Value	Not stored.

Inter-digit Timeout

Description	Specifies the length of time, in seconds, within which subsequent digits of a dial number must be dialed. When this timer expires after the last key was pressed, dialing will start.
Value Range	1–15
Default Value	5

Timer for Dial Plan

Description	Specifies the length of time, in seconds, that the SIP-CS waits before dialing the telephone number modified according to the dial plan.
Value Range	1–15
Default Value	5

International Call Prefix

Description	Specifies the number to be shown in the place of the first "+" symbol when the phone number for incoming international calls contains "+".
Value Range	Max. 8 characters
Default Value	Not stored.

Country Calling Code

Description	Specifies the country/area calling code to be used for comparative purposes when dialing a number from the incoming call log that contains a "+" symbol.
Value Range	Max. 8 characters
Default Value	Not stored.

National Access Code

Description	When dialing a number from the incoming call log that contains a "+" symbol and the country calling code matches, the country calling code is removed and the national access code is added.
Value Range	Max. 8 characters
Default Value	Not stored.

Flash/Recall Button

Description	Selects the function of the FLASH/RECALL button during a conversation.
Value Range	<ul style="list-style-type: none"> • Terminate • Flash Hook
Default Value	Terminate

Flash Hook Event

Description	Selects the type of signal sent when sending a flash hook event.
Value Range	<ul style="list-style-type: none"> • Signal • flashhook
Default Value	Signal

2.6.1.2 Call Rejection Phone Numbers

1–30

Description	Specifies the phone numbers to reject incoming calls from. A maximum of 30 phone numbers can be specified.
Value Range	Max. 32 characters Note <ul style="list-style-type: none"> • Even if you specify nonconsecutive fields (e.g., fields 1, 5, and 30), they will be rearranged into consecutive fields after you save the settings (i.e., 1, 2, and 3). • If the phone number contains characters other than 0–9, *, #, and +, the number may not be rejected correctly.
Default Value	Not stored.

2.6.2 Call Control - PS

This screen allows you to view the current call feature settings for a specific S-PS. Click a numbered tab to view this screen for a particular S-PS.

Panasonic
SIP CS KX-UDS124

Web Logout
Web Port Close

Telephone

Call Control

No.	PS Name	Select Button	Line No.	Phone Number	Select Button
1	001	PS Call Control	1	1100	Line1 Call Control
			2		Line2 Call Control
2		PS Call Control	1		Line1 Call Control
			2		Line2 Call Control
3		PS Call Control	1		Line1 Call Control
			2		Line2 Call Control

2.6.2.1 Call Control

No.

Description	Indicates the table number of the S-PS that is registered to the SIP-CS (reference only).
Value Range	1–255
Default Value	Not applicable.

PS Name

Description	Indicates the currently assigned name of the S-PS (reference only).
Value Range	Max. 20 characters
Default Value	Not applicable.

Line No. 1–2

Description	Indicates the line number of the S-PS that is registered to the SIP-CS (reference only).
Value Range	Line 1–2
Default Value	Not applicable.

Phone Number

Description	Indicates the currently assigned phone numbers (reference only).
Value Range	Max. 32 digits
Default Value	Not applicable.

2.6.3 Call Control [PS]

This screen will be displayed by clicking **[PS Call Control]** on the **[Call Control - PS]** screen. You can configure call features for the desired S-PS on this screen.

The screenshot shows the Panasonic SIP CS KX-UDS124 web interface. The top navigation bar includes 'Status', 'Network', 'System', 'VoIP', 'Telephone', and 'Maintenance'. The 'Telephone' tab is active, and the 'Call Control [PS]' screen is displayed. The left sidebar shows 'Call Control' selected. The main configuration area includes:

- PS Name:** PS Name field with value 001.
- Call Control:** Default Line for Outgoing dropdown menu with value 1.
- Dial Plan:** Dial Plan (max 500 columns) text area.
- Call Even If Dial Plan Does Not Match:** Radio buttons for Yes and No, with Yes selected.

Buttons for 'Web Logout', 'Web Port Close', 'Back', 'All Save', and 'Cancel' are also visible.

2.6.3.1 PS Name

PS Name

Description	Indicates the currently assigned name of the S-PS (reference only).
Value Range	Max. 20 characters
Default Value	Not applicable.

2.6.3.2 Call Control

Default Line for Outgoing

Description	Selects the line used to make an outgoing call when no line is specified in the dialing operation. Note <ul style="list-style-type: none"> The available line number may vary depending on the type of the SIP-CS being used.
Value Range	1–2
Default Value	1

2.6.3.3 Dial Plan

Dial Plan (max 500 columns)

Description	Specifies a dial format, such as specific phone numbers, that control which numbers can be dialed or how to handle the call when making a call. For details, see 6.2 Dial Plan .
Value Range	Max. 500 characters Note <ul style="list-style-type: none"> Entering more than 500 characters in this field causes an error and the previous value remains effective.
Default Value	Not stored.

Call Even If Dial Plan Does Not Match

Description	Selects whether to enable dial plan filtering so that a call is not made when the dialed number does not match any of the dial formats specified in [Dial Plan] .
--------------------	--

Value Range	<ul style="list-style-type: none"> • Yes • No <p>Note</p> <ul style="list-style-type: none"> • If you select [Yes], calls will be made even if the dialed number does not match the dial formats specified in [Dial Plan] (i.e., dial plan filtering is disabled). If you select [No], calls will not be made if the dialed number does not match one of the dial formats specified in [Dial Plan] (i.e., dial plan filtering is enabled).
Default Value	Yes

2.6.4 Call Control [Line 1–2]

This screen will be displayed by clicking **[Linex Call Control]** on the **[Call Control - PS]** screen. You can configure various call features for the selected line of the desired S-PS on this screen.

Panasonic
SIP CS KX-UDS124

Status | Network | System | VoIP | **Telephone** | Maintenance

Web Logout | Web Port Close | Back

Call Control [Line 1]

Telephone

- Call Control
- Button Settings
- Tone Settings
- Telephone Settings
- Import Phonebook
- Export Phonebook

PS Name

PS Name: 001

Phone Number

Phone Number: 1100

Call Control

Display Name:

Voice Mail Access Number:

Enable Shared Call: Yes No

Synchronize Do Not Disturb and Call Forward: Yes No

Call Features

Block Caller ID: Yes No

Block Anonymous Call: Yes No

Do Not Disturb: Yes No

Call Forward

Unconditional	Enable Call Forward	<input type="radio"/> Yes <input checked="" type="radio"/> No
	Phone Number	<input type="text"/>
Busy	Enable Call Forward	<input type="radio"/> Yes <input checked="" type="radio"/> No
	Phone Number	<input type="text"/>
No Answer	Enable Call Forward	<input type="radio"/> Yes <input checked="" type="radio"/> No
	Phone Number	<input type="text"/>
	Ring Count	3 count(s) [0, 2-20]

All Save | Cancel

2.6.4.1 PS Name

PS Name

Description	Indicates the currently assigned name of the S-PS (reference only).
--------------------	---

2.6.4 Call Control [Line 1–2]

Value Range	Max. 20 characters
Default Value	Not applicable.

2.6.4.2 Phone Number

Phone Number

Description	Indicates the currently assigned phone numbers (reference only).
Value Range	Max. 32 digits
Default Value	Not applicable.

2.6.4.3 Call Control

Display Name

Description	Specifies the name to display as the caller on the other party's phone when you make a call.
Value Range	Max. 24 characters Note <ul style="list-style-type: none">You can use Unicode characters for this setting.
Default Value	Not stored.

Voice Mail Access Number

Description	Specifies the phone number used to access the voice mail server. Note <ul style="list-style-type: none">Your phone system must support voice mail.
Value Range	Max. 32 characters
Default Value	Not stored.

Enable Shared Call

Description	Selects whether to enable the Shared Call feature of the SIP server, which is used to share one line among the SIP-CSs. Note <ul style="list-style-type: none">You cannot set both [Enable Shared Call] and [Synchronize Do Not Disturb and Call Forward] to [Yes] at the same time.Availability depends on your phone system.
--------------------	--

Value Range	<ul style="list-style-type: none"> • Yes • No <p>Note</p> <ul style="list-style-type: none"> • If you select [Yes], the SIP server will control the line by using a shared-call signaling method. If you select [No], the SIP server will control the line by using a standard signaling method.
Default Value	No

Synchronize Do Not Disturb and Call Forward

Description	<p>Selects whether to synchronize the Do Not Disturb and Call Forward settings, configured via the Web user interface, between the SIP-CS and the portal server that is provided by your dealer.</p> <p>Note</p> <ul style="list-style-type: none"> • Even if you select [Yes], this feature may not function properly if your phone system does not support it. Before you configure this setting, consult your dealer. • You cannot set both [Enable Shared Call] and [Synchronize Do Not Disturb and Call Forward] to [Yes] at the same time.
Value Range	<ul style="list-style-type: none"> • Yes • No
Default Value	No

2.6.4.4 Call Features

Block Caller ID

Description	<p>Selects whether to make calls without transmitting the phone number to the called party.</p> <p>Note</p> <ul style="list-style-type: none"> • Availability depends on your phone system.
Value Range	<ul style="list-style-type: none"> • Yes • No
Default Value	No

Block Anonymous Call

Description	<p>Selects whether to reject incoming calls that do not show the caller's number.</p>
Value Range	<ul style="list-style-type: none"> • Yes • No

Default Value	No
---------------	----

Do Not Disturb

Description	<p>Selects whether to enable the Do Not Disturb feature for incoming calls.</p> <p>Note</p> <ul style="list-style-type: none"> • If Do Not Disturb has been enabled on the server, the server rejects incoming calls and the SIP-CS does not receive any calls, even if you have selected [No] for this setting. • If you change this setting when [Synchronize Do Not Disturb and Call Forward] is set to [Yes], the change to this setting is not immediately applied on this screen. In this case, reload the screen to confirm that the change is applied.
Value Range	<ul style="list-style-type: none"> • Yes • No
Default Value	No

2.6.4.5 Call Forward

Unconditional (Enable Call Forward)

Description	<p>Selects whether to forward all incoming calls to a specified destination.</p> <p>Note</p> <ul style="list-style-type: none"> • If Do Not Disturb has been enabled on the server, the server rejects incoming calls and the SIP-CS does not receive any calls, even if you have selected [Yes] for this setting. • If you have selected [Yes] for this setting and Call Forward has been enabled on the server, but the forwarding destinations differ, incoming calls are forwarded to the destination set on the server. • If Call Forward has been enabled on the server, incoming calls are forwarded to the destination set on the server, even if you have selected [No] for this setting. • You can synchronize the Do Not Disturb and Call Forward settings from the Web user interface (→ see [Synchronize Do Not Disturb and Call Forward] in 2.6.4.3 Call Control) or through configuration file programming (→ see "FWD_DND_SYNCHRO_ENABLE_PSy_n" in 4.6.1 Call Control Settings). • If you change this setting when [Synchronize Do Not Disturb and Call Forward] is set to [Yes], the change to this setting is not immediately applied on this screen. In this case, reload the screen to confirm that the change is applied.
Value Range	<ul style="list-style-type: none"> • Yes • No

Default Value	No
---------------	----

Unconditional (Phone Number)

Description	<p>Specifies the phone number of the destination to forward all incoming calls to.</p> <p>Note</p> <ul style="list-style-type: none"> If you change this setting when [Synchronize Do Not Disturb and Call Forward] is set to [Yes], the change to this setting is not immediately applied on this screen. In this case, reload the screen to confirm that the change is applied.
Value Range	<p>Max. 32 characters</p> <p>Note</p> <ul style="list-style-type: none"> You cannot leave this field empty if [Unconditional (Enable Call Forward)] is set to [Yes].
Default Value	Not stored.

Busy (Enable Call Forward)

Description	<p>Selects whether to forward incoming calls to a specified destination when the line is in use.</p> <p>Note</p> <ul style="list-style-type: none"> If Do Not Disturb has been enabled on the server, the server rejects incoming calls and the SIP-CS does not receive any calls, even if you have selected [Yes] for this setting. If you have selected [Yes] for this setting and Call Forward has been enabled on the server, but the forwarding destinations differ, incoming calls are forwarded to the destination set on the server. If Call Forward has been enabled on the server, incoming calls are forwarded to the destination set on the server, even if you have selected [No] for this setting. You can synchronize the Do Not Disturb and Call Forward settings from the Web user interface (→ see [Synchronize Do Not Disturb and Call Forward] in 2.6.4.3 Call Control) or through configuration file programming (→ see "FWD_DND_SYNCHRO_ENABLE_PSy_n" in 4.6.1 Call Control Settings). If you change this setting when [Synchronize Do Not Disturb and Call Forward] is set to [Yes], the change to this setting is not immediately applied on this screen. In this case, reload the screen to confirm that the change is applied.
Value Range	<ul style="list-style-type: none"> Yes No
Default Value	No

Busy (Phone Number)

Description	<p>Specifies the phone number of the destination to forward calls to when the line is in use.</p> <p>Note</p> <ul style="list-style-type: none"> If you change this setting when [Synchronize Do Not Disturb and Call Forward] is set to [Yes], the change to this setting is not immediately applied on this screen. In this case, reload the screen to confirm that the change is applied.
Value Range	<p>Max. 32 characters</p> <p>Note</p> <ul style="list-style-type: none"> You cannot leave this field empty if [Busy (Enable Call Forward)] is set to [Yes].
Default Value	Not stored.

No Answer (Enable Call Forward)

Description	<p>Selects whether to forward incoming calls to a specified destination when a call is not answered after it has rung a specified number of times.</p> <p>Note</p> <ul style="list-style-type: none"> If Do Not Disturb has been enabled on the server, the server rejects incoming calls and the SIP-CS does not receive any calls, even if you have selected [Yes] for this setting. If you have selected [Yes] for this setting and Call Forward has been enabled on the server, but the forwarding destinations differ, incoming calls are forwarded to the destination set on the server. If Call Forward has been enabled on the server, incoming calls are forwarded to the destination set on the server, even if you have selected [No] for this setting. You can synchronize the Do Not Disturb and Call Forward from the Web user interface (→ see [Synchronize Do Not Disturb and Call Forward] in 2.6.4.3 Call Control) or through configuration file programming (→ see "FWD_DND_SYNCHRO_ENABLE_PSy_n" in 4.6.1 Call Control Settings). If you change this setting when [Synchronize Do Not Disturb and Call Forward] is set to [Yes], the change to this setting is not immediately applied on this screen. In this case, reload the screen to confirm that the change is applied.
Value Range	<ul style="list-style-type: none"> Yes No
Default Value	No

No Answer (Phone Number)

Description	Specifies the phone number of the destination to forward calls to when a call is not answered after it has rung a specified number of times. Note <ul style="list-style-type: none"> If you change this setting when [Synchronize Do Not Disturb and Call Forward] is set to [Yes], the change to this setting is not immediately applied on this screen. In this case, reload the screen to confirm that the change is applied.
Value Range	Max. 32 characters Note <ul style="list-style-type: none"> You cannot leave this field empty if [No Answer (Enable Call Forward)] is set to [Yes].
Default Value	Not stored.

No Answer (Ring Count)

Description	Specifies the number of times that an incoming call rings until the call is forwarded. Note <ul style="list-style-type: none"> If you change this setting when [Synchronize Do Not Disturb and Call Forward] is set to [Yes], the change to this setting is not immediately applied on this screen. In this case, reload the screen to confirm that the change is applied.
Value Range	0, 2–20 (0: No ring)
Default Value	3

2.6.5 Button Settings

This screen allows you to view the name and phone number of each S-PS. Click a numbered tab to view this screen for a particular S-PS.

The screenshot shows the Panasonic SIP CS KX-UDS124 web interface. The top navigation bar includes 'Status', 'Network', 'System', 'VoIP', 'Telephone', and 'Maintenance'. The 'Telephone' tab is selected. The main content area is titled 'Button Settings' and contains a table with the following data:

No.	PS Name	Phone Number	Select Button	Select Button
1	001	1100	Button Settings	Copy & Paste
2			Button Settings	Copy & Paste
3			Button Settings	Copy & Paste
4			Button Settings	Copy & Paste

2.6.5.1 Button Settings

No.

Description	Indicates the table number of the S-PS that is registered to the SIP-CS (reference only).
Value Range	1–255
Default Value	Not applicable.

PS Name

Description	Indicates the currently assigned name of the S-PS (reference only).
Value Range	Max. 20 characters
Default Value	Not applicable.

Phone Number

Description	Indicates the currently assigned phone numbers (reference only).
Value Range	Max. 32 digits
Default Value	Not applicable.

2.6.6 Button Settings - PS

This screen will be displayed by clicking **[Button Settings]** under **[Select Button]** on the **[Button Settings]** screen. This screen allows you to configure various features for each flexible button. For more details, see **6.3 Flexible Buttons**.

The screenshot shows the Panasonic SIP CS KX-UDS124 web interface. The top navigation bar includes 'Status', 'Network', 'System', 'VoIP', 'Telephone', and 'Maintenance'. The 'Telephone' tab is selected. The main content area is titled 'Button Settings' and includes a 'PS Name' field with the value '001'. Below this is a table for 'Flexible Button Settings' with 12 rows. Each row has columns for 'No.', 'Type', 'Parameter', and 'Label Name'. The 'Type' column contains a dropdown menu with 'DN' selected. The 'Parameter' column contains a text input field with '1' entered. The 'Label Name' column is empty. At the bottom of the table are 'All Save' and 'Cancel' buttons.

2.6.6.1 PS Name

PS Name

Description	Indicates the currently assigned name of the S-PS (reference only).
Value Range	Max. 20 characters
Default Value	Not applicable.

2.6.6.2 Flexible Button Settings

No.

Description	Indicates the number of each flexible button for the S-PS that is registered to the SIP-CS (reference only).
Value Range	1–12
Default Value	Not applicable.

Type (No. 1–12)

Description	Selects the feature to be assigned to each flexible button.
Value Range	<ul style="list-style-type: none">• DN• One-Touch• Not store
Default Value	DN

Parameter (No. 1–12)

Description	Specifies the necessary values for the features assigned to flexible buttons.
Value Range	Max. 32 characters
Default Value	1

Label Name (No. 1–12)

Description	Specifies the message to be displayed on the screen when the flexible button is pressed.
Value Range	Max. 10 characters
Default Value	Not stored.

2.6.7 Button Settings - Copy & Paste

This screen will be displayed by clicking **[Copy & Paste]** under **[Select Source]** on the **[Button Settings]** screen. You can copy the flexible button settings for an S-PS and apply them to other S-PSs on this screen. For more details, see **6.4 Copying Flexible Button Settings to Other S-PSs**.

2.6.7.1 Copy Source PS Name

PS Name

Description	Indicates the currently assigned name of the S-PS (reference only).
Value Range	Max. 20 characters
Default Value	Not applicable.

2.6.7.2 Copy Source Flexible Button Settings

No.

Description	Indicates the number of each flexible button for the S-PS that is registered to the SIP-CS (reference only).
Value Range	1–12

2.6.7 Button Settings - Copy & Paste

Default Value	Not applicable.
----------------------	-----------------

Type (No. 1–12)

Description	Selects the feature to be assigned to each flexible button.
Value Range	<ul style="list-style-type: none">• DN• One-Touch• Not store
Default Value	DN

Parameter (No. 1–12)

Description	Specifies the necessary values for the features assigned to flexible buttons.
Value Range	Max. 32 characters
Default Value	1

Label Name (No. 1–12)

Description	Specifies the message to be displayed on the screen when the flexible button is pressed.
Value Range	Max. 10 characters
Default Value	Not stored.

2.6.7.3 Copy Destination PS Lists

You can copy the flexible button settings as follows.

1. Select the S-PSs to have settings copied to in **[Available PS]**, and then click .
To select all available S-PSs, click . To deselect S-PS(s), click or .
2. Click **[Copy & Paste]**.

2.6.8 Tone Settings

This screen allows you to configure the dual-tone frequencies and ringtone patterns of each tone.

Panasonic
SIP CS KX-UDS124

Status | Network | System | VoIP | **Telephone** | Maintenance

Web Logout
Web Port Close

Telephone

- Call Control
- Button Settings
- Tone Settings**
- Telephone Settings
- Import Phonebook
- Export Phonebook

Tone Settings

Dial Tone	
Tone Frequencies	350,440
Tone Timings	60,0
Busy Tone	
Tone Frequencies	480,620
Tone Timings	60,500,440
Ringing Tone	
Tone Frequencies	440,480
Tone Timings	60,2000,3940
Stutter Tone	
Tone Frequencies	350,440
Tone Timings	560,100,100,100,100,100,100,100,100,100,100,1
Reorder Tone	
Tone Frequencies	480,620
Tone Timings	60,250,190

All Save Cancel

2.6.8.1 Dial Tone

Tone Frequencies

Description	Specifies the dual-tone frequencies, in hertz, of dial tones using 2 whole numbers separated by a comma.
Value Range	0, 200–2000 (0: No tone) Note <ul style="list-style-type: none"> If the value for this setting is "350,440", the SIP-CS will use a mixed signal of a 350 Hz tone and a 440 Hz tone.
Default Value	350,440

Tone Timings

Description	<p>Specifies the pattern, in milliseconds, of dial tones using up to 10 whole numbers (off 1, on 1, off 2, on 2...) separated by commas.</p> <p>Note</p> <ul style="list-style-type: none"> The SIP-CS will not play the tone for the duration of the first value, play it for the duration of the second value, stop it for the duration of the third value, play it again for the duration of the fourth value, and so on. The whole sequence will then repeat. For example, if the value for this setting is "100,100,100,0", the SIP-CS will not play the tone for 100 ms, play it for 100 ms, stop it for 100 ms, and then play it continuously. It is recommended that you set a value of 60 milliseconds or more for the first value (off 1). Avoid setting 1–50 for any of the values.
Value Range	0–16000 (0: Infinite time)
Default Value	60,0

2.6.8.2 Busy Tone

Tone Frequencies

Description	Specifies the dual-tone frequencies, in hertz, of busy tones using 2 whole numbers separated by a comma.
Value Range	0, 200–2000 (0: No tone)
Default Value	480,620

Tone Timings

Description	<p>Specifies the pattern, in milliseconds, of busy tones using up to 10 whole numbers (off 1, on 1, off 2, on 2...) separated by commas.</p> <p>Note</p> <ul style="list-style-type: none"> It is recommended that you set a value of 60 milliseconds or more for the first value (off 1). Avoid setting 1–50 for any of the values.
Value Range	0–16000 (0: Infinite time)
Default Value	60,500,440

2.6.8.3 Ringing Tone

Tone Frequencies

Description	Specifies the dual-tone frequencies, in hertz, of ringback tones using 2 whole numbers separated by a comma.
Value Range	0, 200–2000 (0: No tone)
Default Value	440,480

Tone Timings

Description	Specifies the pattern, in milliseconds, of ringback tones using up to 10 whole numbers (off 1, on 1, off 2, on 2...) separated by commas. Note <ul style="list-style-type: none"> It is recommended that you set a value of 60 milliseconds or more for the first value (off 1). Avoid setting 1–50 for any of the values.
Value Range	0–16000 (0: Infinite time)
Default Value	60,2000,3940

2.6.8.4 Stutter Tone

Tone Frequencies

Description	Specifies the dual-tone frequencies, in hertz, of stutter dial tones to notify that a voice mail is waiting, using 2 whole numbers separated by a comma.
Value Range	0, 200–2000 (0: No tone)
Default Value	350,440

Tone Timings

Description	Specifies the pattern, in milliseconds, of stutter dial tones to notify that a voice mail is waiting, using up to 22 whole numbers (off 1, on 1, off 2, on 2...) separated by commas. Note <ul style="list-style-type: none"> It is recommended that you set a value of 560 milliseconds or more for the first value (off 1). Avoid setting 1–50 for any of the values.
Value Range	0–16000 (0: Infinite time)
Default Value	560,100,0

2.6.8.5 Reorder Tone

Tone Frequencies

Description	Specifies the dual-tone frequencies, in hertz, of reorder tones using 2 whole numbers separated by a comma.
Value Range	0, 200–2000 (0: No tone)
Default Value	480,620

Tone Timings

Description	<p>Specifies the pattern, in milliseconds, of reorder tones using up to 10 whole numbers (off 1, on 1, off 2, on 2...) separated by commas.</p> <p>Note</p> <ul style="list-style-type: none"> It is recommended that you set a value of 60 milliseconds or more for the first value (off 1). Avoid setting 1–50 for any of the values.
Value Range	0–16000 (0: Infinite time)
Default Value	60,250,190

2.6.9 Telephone Settings

This screen allows you to configure the minimum and maximum number of digits with which to match a phonebook entry with an incoming call's caller ID.

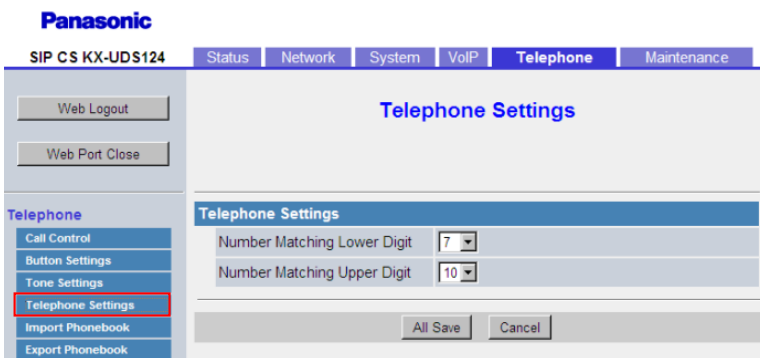

2.6.9.1 Telephone Settings

Number Matching Lower Digit

Description	Specifies the minimum number of digits with which to match a phonebook entry with an incoming call's caller ID. To specify exact matching of entire numbers only, specify "0".
Value Range	1–15

Default Value	7
---------------	---

Number Matching Upper Digit

Description	Specifies the maximum number of digits with which to match a phonebook entry with an incoming call's caller ID. To specify exact matching of entire numbers only, specify "0".
Value Range	1–15
Default Value	10

2.6.10 Import Phonebook - All

This screen allows you to import the phonebook data from a PC to all S-PSs. For details, see **6.1.1 Import/Export Operation**.

Click the **[All]** tab to view this screen.

Note

- If the existing phonebook data has an entry with the same name and phone number as an imported entry, the imported entry is not added as a new entry.
- When you begin transferring the phonebook data, the "Now Processing File Data" screen is displayed, and the screen is periodically reloaded. Depending on your Web browser, the screen might not reload automatically, and you will need to click the text "HERE" before the timer expires in order for the import operation to function properly.

The screenshot shows the Panasonic SIP CS KX-UDS124 web interface. The top navigation bar includes 'Status', 'Network', 'System', 'VoIP', 'Telephone', and 'Maintenance'. The 'Telephone' section is active, and the 'Import Phonebook' screen is displayed. The screen has a left sidebar with 'Import Phonebook' highlighted. The main area contains:

- Import Mode:** Mode selection with radio buttons for 'Direct' (selected) and 'Appoint Date/Time'.
- Import Time Setting:** Date field set to '1 / 31 / 2012' and Time field set to '00 : 00'.
- Import Phonebook:** A 'File Name' input field and a 'Browse...' button.
- An 'All Import' button at the bottom.

2.6.10.1 Import Mode

Mode Select

Description	Selects the method of import.
Value Range	<ul style="list-style-type: none"> • Direct (The import starts immediately.) • Appoint Date/Time (The import starts at the set time.)
Default Value	Direct

2.6.10.2 Import Time Setting

Date

Description	Specifies the month (1–2 digits), date (1–2 digits), and year (4 digits) of the import.
Value Range	Month: 1–12, Date: 1–31, Year: 2000–2099
Default Value	1/31/2012

Time

Description	Specifies hour (1–2 digits) and minute (1–2 digits) of the import.
Value Range	00:00–23:59
Default Value	00:00

2.6.10.3 Import Phonebook

File Name

Description	Specifies the path of the TSV (Tab-separated Value) file to import from the PC.
Value Range	No limitation Note <ul style="list-style-type: none"> There are no limitations for the field entry. However, it is recommended that paths of less than 254 characters be used: longer paths may cause longer data transfer times and result in an internal error.
Default Value	Not stored.

2.6.11 Import Phonebook - PS

This screen allows you to view the name and phone number of each S-PS.

Click a numbered tab to view this screen for a particular S-PS.

The screenshot shows the Panasonic SIP CS KX-UDS124 web interface. The 'Telephone' menu is active, and the 'Import Phonebook' option is highlighted. The main content area displays a table with the following data:

No.	PS Name	Phone Number	Select Button
1	001	1100	Import Phonebook
2			Import Phonebook
3			Import Phonebook
4			Import Phonebook

2.6.11.1 Import Phonebook

No.

Description	Indicates the table number of the S-PS that is registered to the SIP-CS (reference only).
Value Range	1–255
Default Value	Not applicable.

PS Name

Description	Indicates the currently assigned name of the S-PS (reference only).
Value Range	Max. 20 characters
Default Value	Not applicable.

Phone Number

Description	Indicates the currently assigned phone numbers (reference only).
Value Range	Max. 32 digits
Default Value	Not applicable.

2.6.12 Import Phonebook (PS select screen)

This screen will be displayed by clicking **[Import Phonebook]** under **[Select Button]** on the **[Import Phonebook - PS]** screen. You can import the phonebook data from a PC to the desired S-PS.

2.6.12.1 PS Name

PS Name

Description	Indicates the currently assigned name of the S-PS (reference only).
Value Range	Max. 20 characters
Default Value	Not applicable.

2.6.12.2 Import Phonebook

File Name

Description	Specifies the path of the TSV (Tab-separated Value) file to import from the PC.
Value Range	No limitation Note <ul style="list-style-type: none"> There are no limitations for the field entry. However, it is recommended that paths of less than 254 characters be used: longer paths may cause longer data transfer times and result in an internal error.
Default Value	Not stored.

2.6.13 Export Phonebook - PS

This screen allows you to save the phonebook data stored in the S-PS as a TSV file on a PC. For details, see **6.1.1 Import/Export Operation**.

Click a numbered tab to view this screen for a particular S-PS.



2.6.13.1 Export Phonebook

PS Name

Description	Indicates the currently assigned name of the S-PS (reference only).
Value Range	Max. 20 characters
Default Value	Not applicable.

Phone Number

Description	Indicates the currently assigned phone numbers (reference only).
Value Range	Max. 32 digits
Default Value	Not applicable.

2.7 Maintenance

This section provides detailed descriptions about all the settings classified under the **[Maintenance]** tab.

2.7.1 Backup

This screen allows you to backup the Super Master CS configuration data for the recovery of the Super Master CS. For details, see **8.1 How to back up and restore configuration data.**

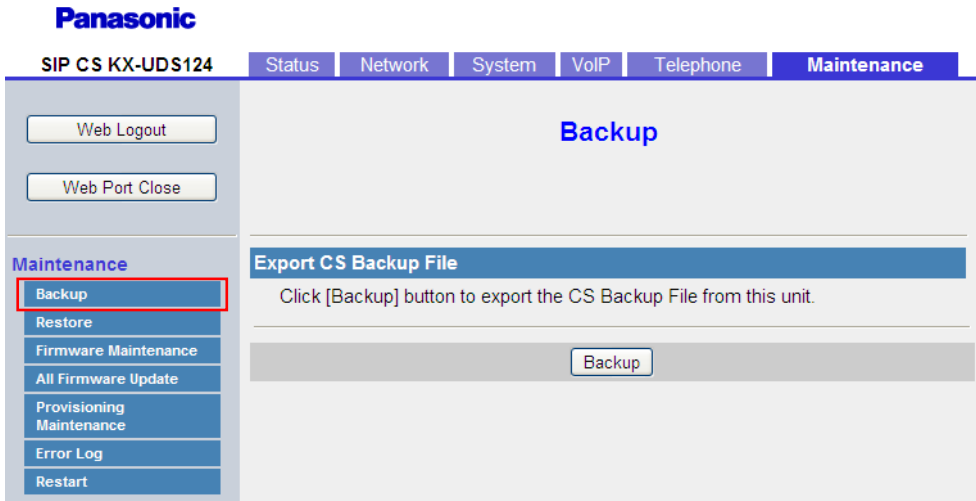

2.7.2 Restore

This screen allows you to restore Super Master CS configurations for the recovery of the Super Master CS. For details, see **8.1 How to back up and restore configuration data.**

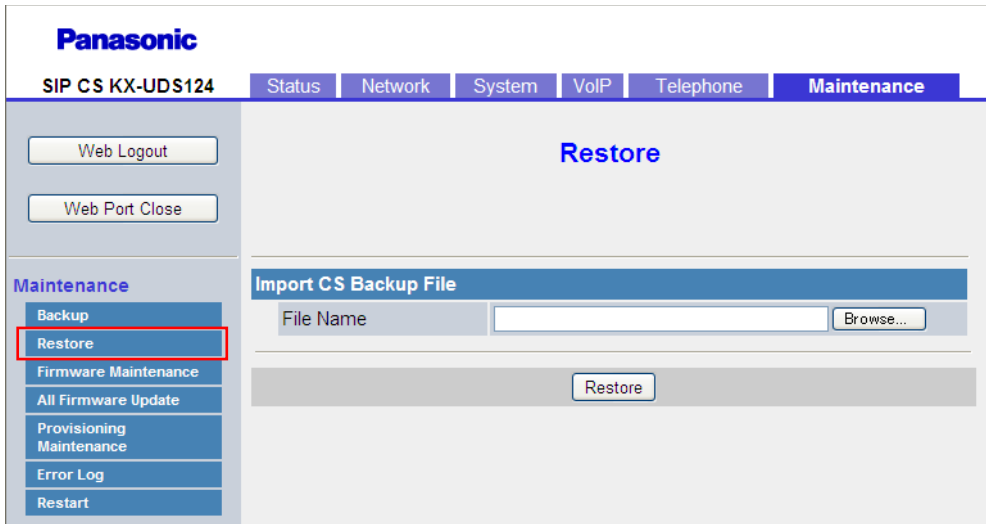

2.7.3 Firmware Maintenance

This screen allows you to perform firmware updates automatically or manually.

The screenshot shows the Panasonic SIP CS KX-UDS124 web interface. The top navigation bar includes 'Status', 'Network', 'System', 'VoIP', 'Telephone', and 'Maintenance'. The 'Maintenance' section is active, showing a sidebar with options like 'Backup', 'Restore', 'Firmware Maintenance' (highlighted), 'All Firmware Update', 'Provisioning Maintenance', 'Error Log', and 'Restart'. The main content area is titled 'Firmware Maintenance' and contains the following configuration options:

- Enable Firmware Update:** Radio buttons for Yes (selected) and No.
- Firmware File URL:** A text input field.
- PS Update Type:** Radio buttons for Automatic (selected) and Manual.

At the bottom of the configuration area are 'All Save' and 'Cancel' buttons.

2.7.3.1 Firmware Maintenance

Enable Firmware Update

Description	Selects whether to perform firmware updates when the SIP-CS detects a newer version of firmware. Note <ul style="list-style-type: none"> Changing this setting may require restarting the SIP-CS. Local firmware updates from the Web user interface (→ see 2.7.4 All Firmware Update) can be performed regardless of this setting. Firmware updates using TR-069 can be performed regardless of this setting.
Value Range	<ul style="list-style-type: none"> Yes No
Default Value	Yes

Firmware File URL

Description	Specifies the URL where the firmware file is stored. Note <ul style="list-style-type: none"> This setting is available only when [Enable Firmware Update] is set to [Yes]. Changing this setting may require restarting the SIP-CS.
Value Range	Max. 500 characters

2.7.4 All Firmware Update

Default Value	Not stored.
---------------	-------------

PS Update Type

Description	Selects whether to display a confirmation message asking the user to perform a firmware update (manual) or perform the firmware update without asking the user (automatic) when the S-PS detects a newer version of firmware. Note <ul style="list-style-type: none"> This setting is available only when [Enable Firmware Update] is set to [Yes]. Changing this setting may require restarting the SIP-CS.
Value Range	<ul style="list-style-type: none"> Automatic Manual
Default Value	Automatic

2.7.4 All Firmware Update

This screen allows you to manually update the firmware of all SIP-CSs from a PC by clicking **[All Update Firmware]**.

Note

- After the firmware has been successfully updated, the SIP-CS will restart automatically.

Panasonic

SIP CS KX-UDS124 Status Network System VoIP Telephone **Maintenance**

Web Logout
Web Port Close

Maintenance

- Backup
- Restore
- Firmware Maintenance
- All Firmware Update**
- Provisioning Maintenance
- Error Log
- Restart

All Firmware Update

Update Mode

Mode Direct Appoint Date/Time

Update Time Setting

Date 1 / 31 / 2012 [mm / dd / yyyy]

Time 00 : 00 [hh : mm]

Update Firmware

Encryption Yes No

File Name

2.7.4.1 Update Mode

Mode

Description	Selects the mode for firmware update.
Value Range	<ul style="list-style-type: none"> • Direct (The update starts immediately.) • Appoint Date/Time (The update starts at the set time.)
Default Value	Direct

2.7.4.2 Update Time Setting

Date

Description	Specifies the month (1–2 digits), date (1–2 digits), and year (4 digits) of the update.
Value Range	Month: 1–12, Date: 1–31, Year: 2000–2099
Default Value	1/31/2012

Time

Description	Specifies the hour (1–2 digits) and minute (1–2 digits) of the update.
Value Range	00:00–23:59
Default Value	00:00

2.7.4.3 Update Firmware

Encryption

Description	Selects whether the firmware files are encrypted or not. Note <ul style="list-style-type: none"> • When the provided firmware files are encrypted, select [Yes]. Usually, the provided firmware files are encrypted.
Value Range	<ul style="list-style-type: none"> • Yes • No
Default Value	Yes

File Name

Description	Specifies the path of the firmware file to be imported.
--------------------	---

2.7.5 Provisioning Maintenance

Value Range	No limitation Note <ul style="list-style-type: none"> There are no limitations for the field entry. However, it is recommended that paths of less than 254 characters be used: longer paths may cause longer data transfer times and result in an internal error.
Default Value	Not stored.

2.7.5 Provisioning Maintenance

This screen allows you to change the provisioning setup to download the configuration files from the provisioning server of your phone system.

Note

- Each SIP-CS can accept up to 3 configuration files. For details about provisioning, see **3.2 Provisioning**.

Panasonic

SIP CS KX-UDS124 | Status | Network | System | VoIP | Telephone | **Maintenance**

Web Logout | Web Port Close

Maintenance

- Backup
- Restore
- Firmware Maintenance
- All Firmware Update
- Provisioning Maintenance**
- Error Log
- Restart

Provisioning Maintenance

Enable Provisioning	<input checked="" type="radio"/> Yes <input type="radio"/> No
Standard File URL	<input type="text" value="http://192.168.0.23:7580/utdownload/Standard."/>
Product File URL	<input type="text"/>
Master File URL	<input type="text"/>
System File URL	<input type="text" value="http://192.168.0.23:7580/utdownload/System.c"/>
Cyclic Auto Resync	<input type="radio"/> Yes <input checked="" type="radio"/> No
Resync Interval	<input type="text" value="10080"/> minute(s) [1-40320]
Header Value for Resync Event	<input type="text" value="check-sync"/>

All Save | Cancel

2.7.5.1 Provisioning Maintenance

Enable Provisioning

Description	Selects whether the SIP-CS is automatically configured by downloading the configuration files from the provisioning server of your phone system. Note <ul style="list-style-type: none"> • Downloading configuration files using TR-069 can be performed regardless of this setting.
Value Range	<ul style="list-style-type: none"> • Yes • No
Default Value	Yes

Standard File URL

Description	Specifies the URL of the standard configuration file, which is used when every SIP-CS needs different settings. Note <ul style="list-style-type: none"> • When you change this setting, set [Enable Provisioning] to [Yes] at the same time.
Value Range	Max. 500 characters
Default Value	http://provisioning.e-connecting.net/redirect/conf/{mac}.cfg

Product File URL

Description	Specifies the URL of the product configuration file, which is used when all SIP-CSs with the same model number need the same settings. Note <ul style="list-style-type: none"> • When you change this setting, set [Enable Provisioning] to [Yes] at the same time.
Value Range	Max. 500 characters
Default Value	Not stored.

Master File URL

Description	Specifies the URL of the master configuration file, which is used when all SIP-CSs need the same settings. Note <ul style="list-style-type: none"> • When you change this setting, set [Enable Provisioning] to [Yes] at the same time.
--------------------	--

2.7.5 Provisioning Maintenance

Value Range	Max. 500 characters
Default Value	Not stored.

System File URL

Description	Specifies the URL of the system configuration file, which is used when all SIP-CSs in the system need the same settings. Note <ul style="list-style-type: none">When you change this setting, set [Enable Provisioning] to [Yes] at the same time.
Value Range	Max. 500 characters
Default Value	Not stored.

Cyclic Auto Resync

Description	Selects whether the SIP-CS periodically checks for updates of configuration files.
Value Range	<ul style="list-style-type: none">YesNo
Default Value	No

Resync Interval

Description	Specifies the interval, in minutes, between periodic checks for updates of the configuration files.
Value Range	1–40320
Default Value	10080

Header Value for Resync Event

Description	Specifies the value of the "Event" header sent from the SIP server to the SIP-CS so that the SIP-CS can access the configuration files on the provisioning server.
Value Range	Max. 15 characters
Default Value	check-sync

2.7.6 Error Log

This screen allows you to export the error log from the SIP-CS by clicking **[Export]**.

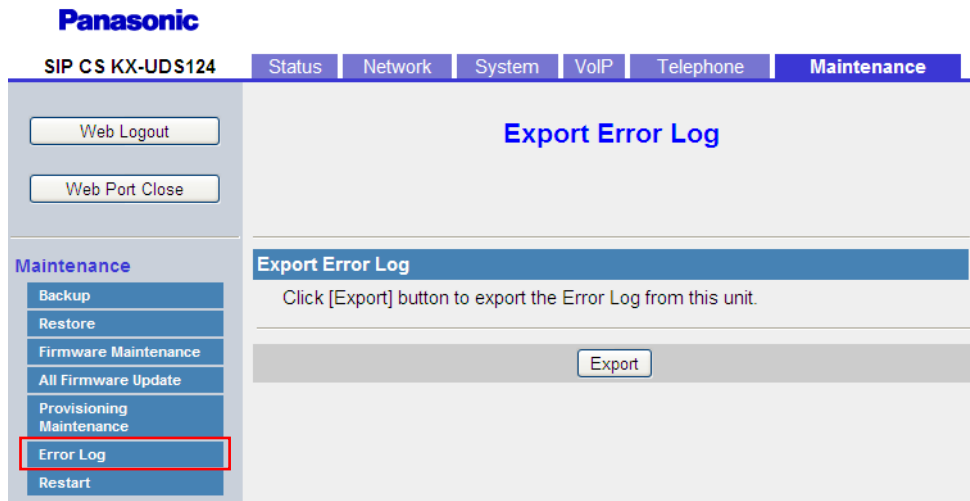

2.7.7 Restart

This screen allows you to restart the SIP-CS by clicking **[Restart]**. After you click this button, a dialog box is displayed, asking whether you want to restart the SIP-CS. Click **[OK]** to perform a restart, or **[Cancel]**.

Notice

- The SIP-CS will restart even if it is on a call.

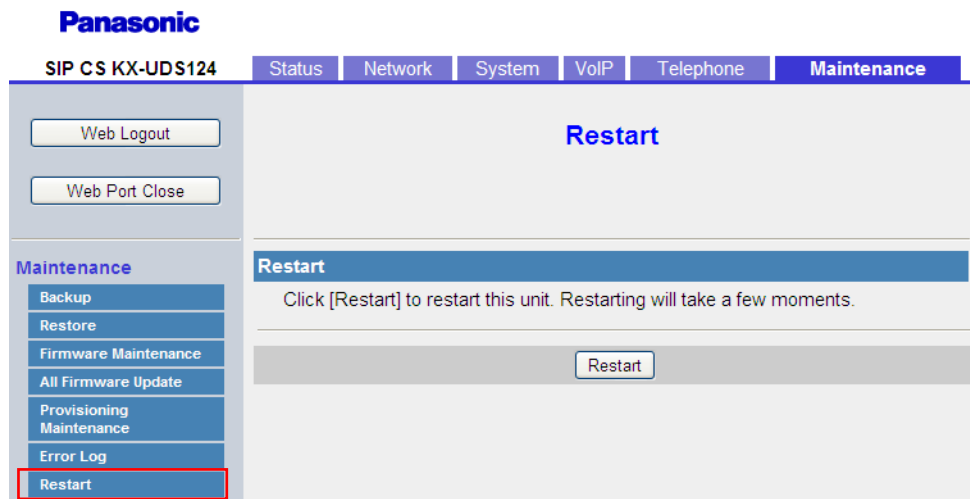

2.7.7 Restart

Section 3

General Information on Provisioning

This section provides an overview of the configuration file programming procedures for the SIP-CS, including pre-provisioning and provisioning.

3.1 Pre-provisioning

3.1.1 What is Pre-provisioning?

To perform pre-provisioning, you must set the IP address of a TFTP server to the DHCP server option 66 so that the SIP-CS can acquire the TFTP server address. When the SIP-CS starts up and no configuration has been applied, it will automatically acquire the address of the TFTP server and download the configuration file. For details about the configuration file, see **3.2.3 Configuration File**.

For details about the settings that can be configured with the configuration files and how to specify the settings, see **Section 4 Configuration File Programming**.

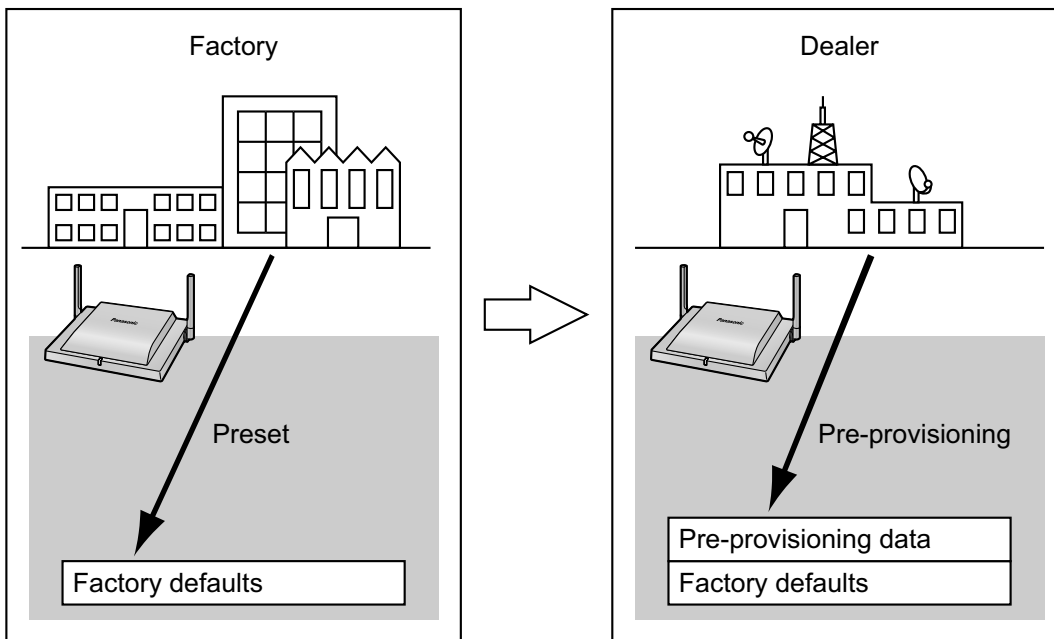

Pre-provisioning can aid the installation process by allowing dealers to configure beforehand the minimum settings required to operate the SIP-CS.

For example, dealers can store on the TFTP server a configuration file that contains only the URL of a server where another configuration file is stored. This second configuration file contains settings configured specifically for the usage environment of the user. The user will be able to start using the SIP-CS by just connecting it to the network.

Pre-provisioning is performed only once after the SIP-CS has been shipped. Once configuration by pre-provisioning or provisioning has been applied, pre-provisioning will not be performed again.

Note that the settings configured by pre-provisioning cannot be restored once it has been performed. If you want to restore them, consult your dealer.

Although pre-provisioning is often used to specify the location of the configuration files for provisioning, you can configure any of the settings through pre-provisioning. The SIP-CS can be made fully operational by configuring settings through pre-provisioning.

3.1.2 Pre-provisioning when Setting Static IP Addresses

To perform pre-provisioning, the SIP-CS needs to acquire the TFTP server address from option 66 on a DHCP server. Therefore, pre-provisioning cannot be performed if you use static IP addressing on your network. If you

use static IP addressing and want to perform pre-provisioning, construct a small, separate network and connect a DHCP and TFTP server to that network.

In addition, if option 66 of the DHCP server cannot be set, or if you are unauthorized to change this setting, perform pre-provisioning on the separate network, and then connect the SIP-CS to the actual network.

3.1.3 Server for Pre-provisioning

The DHCP server and TFTP server play important roles in performing pre-provisioning. This section explains their purposes, uses, and brief descriptions.

Server	Purpose	Description
DHCP server	Used to provide the address of a TFTP server, set in option 66 of the DHCP server, to SIP-CSs that have not been configured yet.	In option 66 of the DHCP server, specify the IP address or FQDN (Fully Qualified Domain Name) of the TFTP server. For details, refer to the documentation for your DHCP server. Note <ul style="list-style-type: none"> The maximum length of FQDN text is 255 bytes.
TFTP server	Used to store configuration files, and is set as the access point for downloading them automatically.	The SIP-CS will download the configuration file "(model name).cfg" stored in the root directory of the TFTP server. For example, if the model name is KX-UDS124, the SIP-CS will download the configuration file "/KX-UDS124.cfg".

DHCP and TFTP servers may be supplied with your operating system, provided through commercial services, and are also distributed freely on the Internet. Use a server setup that best matches your environment.

When installing and setting up the DHCP server and TFTP server, refer to the documentation supplied with the product. For details about connecting servers to the network and managing them, consult your network administrator.

3.1.4 Pre-provisioning Setting Example

This section gives an example of how to perform pre-provisioning.

Assumptions

Item	Description/Setting
TFTP server address	192.168.0.130
Distribution directory of TFTP server	/tftpboot
Model name of the SIP-CS	KX-UDS124
MAC address of the SIP-CS	0080F0123456
Provisioning server name (where the configuration file used for provisioning is to be stored)	provisioning.example.com
Distribution directory of the provisioning server	/Panasonic

3.1.4 Pre-provisioning Setting Example

Item	Description/Setting
File name of the configuration file used for provisioning	Config0080F0123456.cfg
URL of the configuration file used for provisioning	http://provisioning.example.com/Panasonic/Config0080F0123456.cfg

Prior Settings

Item	Description/Setting
DHCP server option 66	192.168.0.130
IP address range assigned by DHCP server	192.168.0.16 to 192.168.0.63
File name of the configuration file used for pre-provisioning	KX-UDS124.cfg
URL of the configuration file used for provisioning that is entered in the configuration file	<code>CFG_STANDARD_FILE_PATH="http://provisioning.example.com/Panasonic/Config{MAC}.cfg"</code> Note <ul style="list-style-type: none">"{MAC}" is replaced by the MAC address of the SIP-CS. (e.g., "0080F0123456")
Stored location of the configuration file on the TFTP server	Configuration file "KX-UDS124.cfg" is stored in the directory "/tftpboot".

The pre-provisioning process

Step 1

Connect the SIP-CS to the network, and turn the power on. The SIP-CS is assigned an IP address by the DHCP server, and also receives the TFTP server address from the DHCP server using DHCP server option 66.

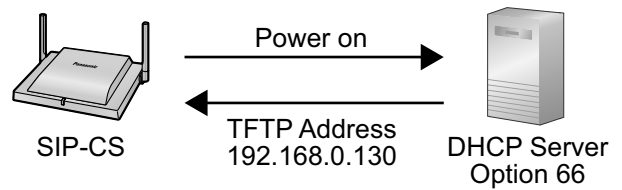

Step 2

The SIP-CS downloads the configuration file for pre-provisioning from the TFTP server:
tftp://192.168.0.130/KX-UDS124.cfg

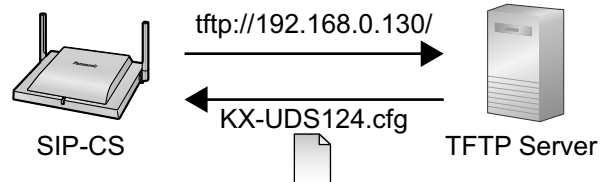

Step 3

The URL of the server where the configuration file for provisioning is stored (provisioning server) is set to the SIP-CS:

http://provisioning.example.com/Panasonic/
Config{MAC}.cfg

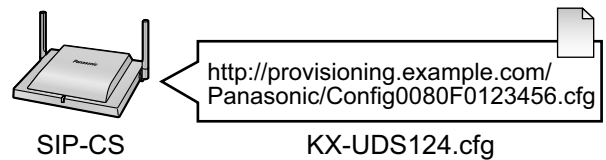

Step 4

When pre-provisioning is complete, the SIP-CS's LED will flash red, amber and green alternately.

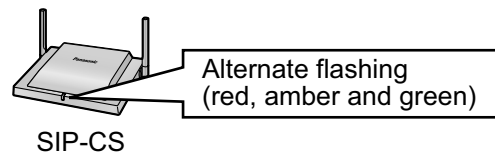

Step 5

When the LED is flashing alternately, turn off the SIP-CS's power, then turn it back on.

The SIP-CS may restart automatically depending on the configuration file programming (→ see "OPTION66_REBOOT" in 4.2.5 Provisioning Settings).

When the SIP-CS is distributed to end users and started up in real circumstances, provisioning will be performed correctly.

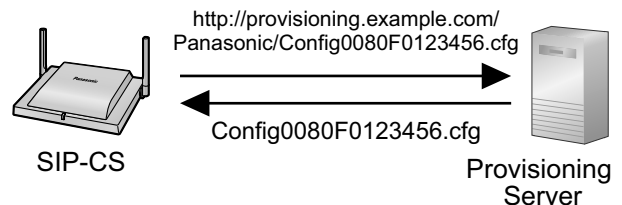

Note

- This example describes the case when only one SIP-CS is connected. However, multiple SIP-CSs can be configured through the same procedure without changing any settings, because the MAC address is specified by the {MAC} macro.

3.2 Provisioning

3.2.1 What is Provisioning?

After pre-provisioning has been performed (→ see **3.1 Pre-provisioning**), you can set up the SIP-CS automatically by downloading the configuration file stored on the provisioning server into the SIP-CS. This is called "provisioning".

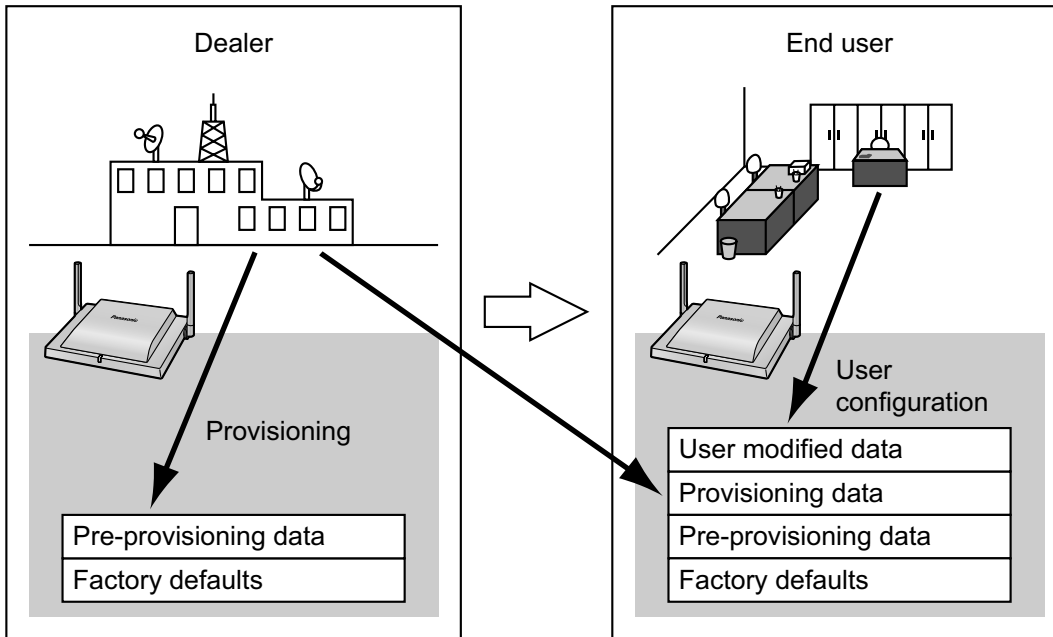

3.2.2 Protocols for Provisioning

Provisioning can be performed over HTTP, HTTPS, FTP, and TFTP. The protocol you should use differs depending on how you will perform provisioning. Normally, HTTP, HTTPS, or FTP is used for provisioning. If you are transmitting encrypted configuration files, it is recommended that you use HTTP. If you are transmitting unencrypted configuration files, it is recommended that you use HTTPS. You may not be able to use FTP depending on the conditions of the network router or the network to be used.

3.2.3 Configuration File

This section gives concrete examples of the functions of the configuration file and how to manage it. The configuration file is a text file that contains the various settings that are necessary for operating the SIP-CS. The files are normally stored on a server maintained by your dealer, and will be downloaded to the SIP-CSs as required. All configurable settings can be specified in the configuration file. You can ignore settings that already have the desired values. Only change parameters as necessary.

For details about setting parameters and their descriptions, see **Section 4 Configuration File Programming**.

Using 4 Types of Configuration Files

The SIP-CS can download up to 4 configuration files. One way to take advantage of this is by classifying the configuration files into the following 4 types:

Type	Usage	Common to all SIP-CSs
System configuration file	<p>Configure settings that are common to all SIP-CSs, such as the SIP server address, and the IP addresses of the DNS and NTP (Network Time Protocol) servers managed by your dealer. This configuration file is used by all the SIP-CSs.</p> <p>Example of the configuration file's URL: http://prov.example.com/Panasonic/{MODEL}.cfg</p> <p>Note</p> <ul style="list-style-type: none"> When a SIP-CS requests the configuration file, "{MODEL}" is replaced by the model name of the SIP-CS. 	Yes
Master configuration file	<p>Configure settings that are common to all SIP-CSs, such as the SIP User ID, password, and IPEI. This configuration file is used by all the SIP-CSs.</p> <p>Example of the configuration file's URL: http://prov.example.com/Panasonic/UserAccount.cfg</p>	Yes
Product configuration file	<p>Configure settings that are unique to each SIP-CS, such as the CS name. If necessary, each CS will download the corresponding configuration file.</p> <p>Example of the configuration file's URL: http://prov.example.com/Panasonic/Config{MAC}.cfg</p> <p>Note</p> <ul style="list-style-type: none"> When a SIP-CS requests the configuration file, "{MAC}" is replaced by the MAC address of the SIP-CS. 	No
Standard configuration file	<p>Configure settings that are unique to each SIP-CS, for future enhancement. If necessary, each CS will download the corresponding configuration file.</p> <p>Example of the configuration file's URL: http://prov.example.com/Panasonic/Config{MAC}.cfg</p> <p>Note</p> <ul style="list-style-type: none"> When a SIP-CS requests the configuration file, "{MAC}" is replaced by the MAC address of the SIP-CS. 	No

Usually, you only need to use the System and Master configuration files. If you need to centralize provisioning to the Super Master CS, set the "**PROVISION_SUPERMASTER_ONLY**" parameter to "Y" (→ see **4.2.6 Other Settings**). As a result, these two files are distributed to all other SIP-CSs automatically and other SIP-CSs do

3.2.4 Downloading Configuration Files

not need to perform provisioning. In this case, the Standard and Product configuration files can also only be used by the Super Master CS.

Depending on the situation, you can use all 4 types of configuration files, and can also use only a Master configuration file.

The above example shows only one possible way to use configuration files. Depending on the requirements of your dealer, there are a number of ways to use configuration files effectively.

3.2.4 Downloading Configuration Files

Downloading a Configuration File via the Web User Interface

The following procedure describes how to enable downloading a configuration file via the Web User Interface to be used for programming the SIP-CS.

1. Confirm that the provisioning server's IP address/FQDN and directory are correct, and store the configuration files in the directory (e.g., `http://provisioning.example.com/Panasonic/Config_Sample.cfg`).
2. Enter the IP address of the SIP-CS into the PC's Web browser.
3. Log in as the administrator.
4. Click the **[Maintenance]** tab, click **[Provisioning Maintenance]**, and then select **[Yes]** for **[Enable Provisioning]**.
5. Enter the URL set up in Step 1 in **[Standard File URL]**.
6. Click **[Save]**.

Timing of Downloading

A SIP-CS downloads configuration files when it starts up, at regular intervals, and when directed to do so by the server. In addition, you can prohibit SIP-CSs from downloading the configuration files. For details about the settings, see **2.7.5 Provisioning Maintenance** and **4.2.5 Provisioning Settings**.

Download Timing	Explanation
Startup	The configuration files are downloaded when the SIP-CS starts up.

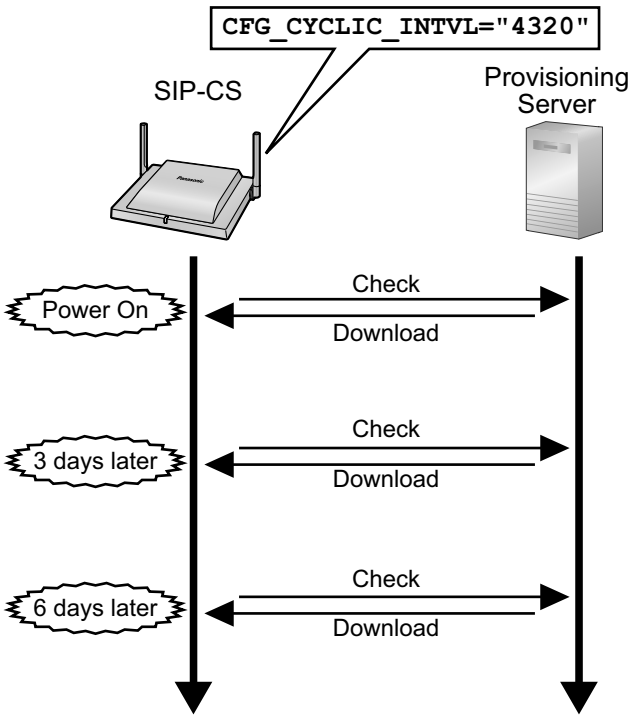
Download Timing	Explanation
At regular intervals of time	<p>The configuration files are downloaded at specified intervals of time, set in minutes. In the example below, the SIP-CS has been programmed to check for and download configuration files from the provisioning server every 3 days (4320 minutes).</p>  <p>The configuration files are downloaded periodically under the following conditions:</p> <ul style="list-style-type: none"> • In the configuration file, add the line, <code>CFG_CYCLIC="Y"</code>. <ul style="list-style-type: none"> – Set an interval (minutes) by specifying "<code>CFG_CYCLIC_INTVL</code>". • In the Web user interface: <ul style="list-style-type: none"> – Click the [Maintenance] tab, click [Provisioning Maintenance], and then select [Yes] for [Cyclic Auto Resync]. – Enter an interval (minutes) in [Resync Interval]. <p>Note</p> <ul style="list-style-type: none"> • The interval may be determined by your dealer. A maximum interval of 28 days (40320 minutes) can be set on the SIP-CS.

3.2.4 Downloading Configuration Files

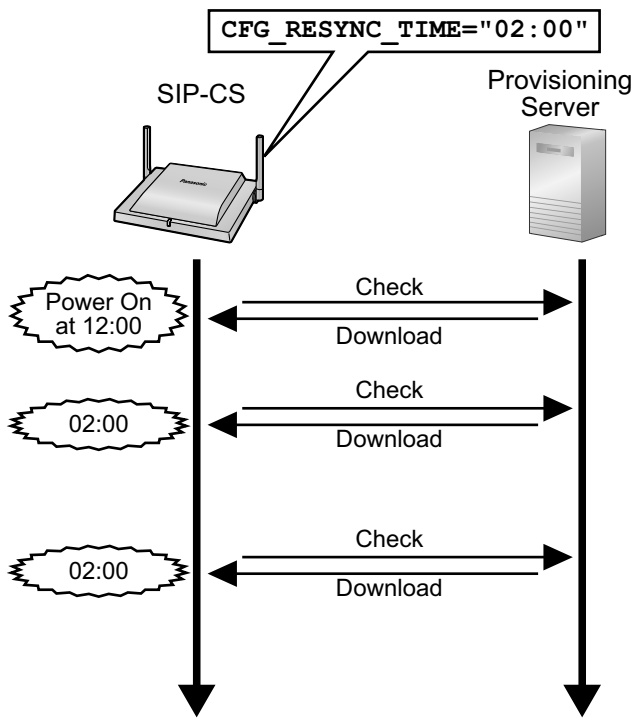
Download Timing	Explanation
At a specified time each day	<p>After the SIP-CS is powered on, it will check for and download configuration files once per day at the specified time.</p>  <p>The configuration files are downloaded at a set time each day:</p> <ul style="list-style-type: none"> • Set a time by specifying "CFG_RESYNC_TIME". <p>Note</p> <ul style="list-style-type: none"> • If the value for "CFG_RESYNC_TIME" is any valid value other than an empty string, the SIP-CS downloads the configuration files at the fixed time, and the settings specified in "CFG_CYCLIC", "CFG_CYCLIC_INTVL", and "CFG_RTRY_INTVL" are disabled. • The time is specified using a 24-hour clock ("00:00" to "23:59").
When directed	<p>When a setting needs to be changed immediately, SIP-CSs can be directed to download the configuration files by sending them a NOTIFY message that includes a special event from the SIP server.</p> <ul style="list-style-type: none"> • In the configuration file: <ul style="list-style-type: none"> – Specify the special event text in "CFG_RESYNC_FROM_SIP". • In the Web user interface: <ul style="list-style-type: none"> – Click the [Maintenance] tab, click [Provisioning Maintenance], and then enter the special event text in [Header Value for Resync Event]. <p>Generally, "check-sync" or "resync" is set as the special event text.</p>

Download Timing	Explanation
None (prohibited)	<p>If you want to prohibit SIP-CSs from changing their settings by downloading configuration files, you can enable this function from the Web user interface. The following operations will be prohibited:</p> <ul style="list-style-type: none"> – Pre-provisioning – Provisioning at startup – Provisioning at regular intervals – Provisioning by sending a NOTIFY message • In the configuration file: <ul style="list-style-type: none"> – Add the line, <code>PROVISION_ENABLE="N"</code>. • In the Web user interface: <ul style="list-style-type: none"> – Click the [Maintenance] tab, click [Provisioning Maintenance], and then select [No] for [Enable Provisioning]. • To enable provisioning again, in the Web user interface: <ul style="list-style-type: none"> – Click the [Maintenance] tab, click [Provisioning Maintenance], and then select [Yes] for [Enable Provisioning].

3.2.5 Provisioning Server Setting Example

This section gives an example of how to set up the SIP-CSs and provisioning server when configuring 2 SIP-CSs with configuration files. The System and Master configuration files are used in this example.

Conditions

Item	Description/Setting
Provisioning server FQDN	prov.example.com
SIP-CS's MAC address	0080F0111111
URL of the configuration files	<p>Configure the following 2 settings either by pre-provisioning or through the Web user interface. The values of both settings must be the same.</p> <ul style="list-style-type: none"> • <code>CFG_SYSTEM_FILE_PATH="http://prov.example.com/Panasonic/KX-UDS124.cfg"</code> • <code>CFG_MASTER_FILE_PATH="http://prov.example.com/Panasonic/UserAccount.cfg"</code>
Directory on the provisioning server containing the configuration files	Create the "Panasonic" directory just under the HTTP root directory of the provisioning server.
File name of configuration files	<p>Store the following configuration files in the "Panasonic" directory.</p> <ul style="list-style-type: none"> • Contains the common settings for all SIP-CSs: <ul style="list-style-type: none"> – UserAccount.cfg • Contains the settings for all SIP-CSs of the same model: <ul style="list-style-type: none"> – KX-UDS124.cfg

To set up the provisioning server

1. Connect the SIP-CSs to the network, and turn them on.
2. The SIP-CS with the MAC address 0080F0111111 accesses the following URLs:
<http://prov.example.com/Panasonic/UserAccount.cfg>
<http://prov.example.com/Panasonic/KX-UDS124.cfg>

3.2.6 Encryption

Example Provisioning Direction from the Server

The following figure shows an example NOTIFY message from the server, directing the SIP-CSs to perform provisioning. The text "check-sync" is specified for "CFG_RESYNC_FROM_SIP".

```
NOTIFY sip:1234567890@sip.example.com SIP/2.0
Via: SIP/2.0/UDP xxx.xxx.xxx.xxx:5060;branch=abcdef-ghijkl
From: sip:prov@sip.example.com
To: sip:1234567890@sip.example.com
Date: Thu, 1 Jan 2009 01:01:01 GMT
Call-ID: 123456-1234567912345678
CSeq: 1 NOTIFY
Contact: sip:xxx.xxx.xxx.xxx:5060
Event: check-sync
Content-Length: 0
```

3.2.6 Encryption

Secure Provisioning Methods

In order to perform provisioning securely, there are 2 methods for transferring configuration files securely between the SIP-CS and the server.

Which method is used depends on the environment and equipment available from the phone system.

Method 1: Transferring Encrypted Configuration Files

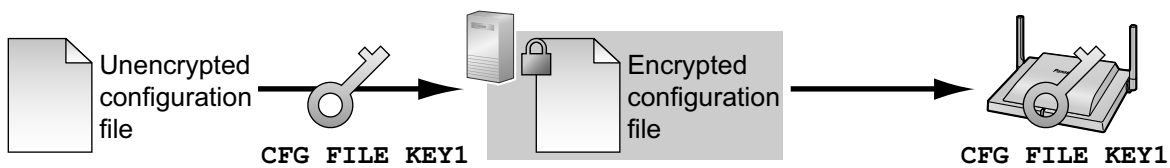

To use this method, an encryption key is required to encrypt and decrypt the configuration files. A preset encryption key unique to each SIP-CS, an encryption key set by your dealer, etc., is used for the encryption. When the SIP-CS downloads an encrypted configuration file, it will decrypt the file using the same encryption key, and then configure the settings automatically.

Method 2: Transferring Configuration Files Using HTTPS

This method uses SSL, which is commonly used on the Internet, to transfer configuration files between the SIP-CS and server. For more secure communication, you can use a root certificate.

Notice

- To avoid redundant data transfer over the network, important data, such as the encryption key used to encrypt the configuration files and the root certificate for SSL, should be configured through pre-provisioning as much as possible.
- It is recommended that you encrypt the data in order to keep the communication secure when transferring configuration files. However, if you are using the SIP-CSs within a secure environment, such as within an intranet, it is not necessary to encrypt the data.

To decrypt configuration files, the SIP-CS uses the encryption key registered to it beforehand. The SIP-CS determines the encryption status by checking the extension of the downloaded configuration file.

For details about encrypting configuration files, contact the appropriate person in your organization.

Extension of Configuration File	Configuration File Parameters Used for Decrypting
".e1c"	CFG_FILE_KEY1
".e2c"	CFG_FILE_KEY2
".e3c"	CFG_FILE_KEY3
".e4c"	CFG_FILE_KEY4
Other than ".e1c", ".e2c", ".e3c", and ".e4c"	Processed as unencrypted configuration files. The extension ".cfg" should be used for unencrypted configuration files.

Comparison of the 2 Methods

The following table compares the characteristics for the 2 transfer methods.

	Transferring Encrypted Configuration Files	Transferring Configuration Files Using HTTPS
Provisioning server load	Light	Heavy (The server encrypts data for each transmission.)
Operation load	Necessary to encrypt data beforehand.	Unnecessary to encrypt data beforehand.
Management of configuration files	Files must be decrypted and re-encrypted for maintenance.	It is easy to manage files because they are not encrypted on the server.
Security of data on the server when operating	High	Low (Configuration files are readable by anyone with access to the server.)

Moreover, there is another method: configuration files are not encrypted while stored on the server, and then, using the encryption key registered to the SIP-CS beforehand, they are encrypted when they are transferred. This method is particularly useful when several SIP-CSs are configured to download a common configuration file using different encryption keys. However, as when downloading an unencrypted configuration file using HTTPS, the server will be heavily burdened when transferring configuration files.

3.3 Priority of Setting Methods

The same settings can be configured by different configuration methods: provisioning, Web user interface programming, etc. This section explains which value is applied when the same setting is specified by multiple methods.

The following table shows the priority with which settings from each method are applied (lower numbers indicate higher priority):

Setting Order	Priority	Setting Method
1	4	The factory default settings for the SIP-CS
2	3	Pre-provisioning with the configuration file

3.4 Configuration File Specifications

Setting Order	Priority	Setting Method
3	2-4	Provisioning with the system configuration file
	2-3	Provisioning with the master configuration file
	2-2	Provisioning with the product configuration file
	2-1	Provisioning with the standard configuration file
4	1	Settings configured from the Web user interface

According to the table, settings configured later override previous settings (i.e., settings listed lower in the table have a higher priority).

If different values are specified for the same setting by the master configuration file and Web user interface programming, the value specified from the Web user interface is applied. This is because values specified from the Web user interface have a higher priority.

For settings configured from the Web user interface, the value specified most recently receives priority.

3.4 Configuration File Specifications

The specifications of the configuration files are as follows:

File Format

The configuration file is in plain text format.

File Size

The maximum size of a configuration file is 2040 KB. Regardless of the number of configuration files, the total size of the configuration files must be 2040 KB or less.

Lines in Configuration Files

A configuration file consists of a sequence of lines, with the following conditions:

- Each line must end with "<CR><LF>".
- The maximum length of a line is 537 bytes including "<CR><LF>".
- The following lines are ignored:
 - Lines that exceed the limit of 537 bytes
 - Empty lines
 - Comment lines that start with "#"
- Configuration files must start with a comment line containing the following designated character sequence (44 bytes):
Panasonic SIP Phone Standard Format File
The hexadecimal notation of this sequence is:
**23 20 50 61 6E 61 73 6F 6E 69 63 20 53 49 50 20
50 68 6F 6E 65 20 53 74 61 6E 64 61 72 64 20 46
6F 72 6D 61 74 20 46 69 6C 65 20 23**
- To prevent the designated character sequence being altered by chance, it is recommended that the configuration file starts with the comment line shown below:
Panasonic SIP Phone Standard Format File # DO NOT CHANGE THIS LINE!
- Configuration files must end with an empty line.
- Each parameter line is written in the form of `XXX="yyy"` (XXX: parameter name, yyy: parameter value). The value must be enclosed by double quotation marks.
- A parameter line written over multiple lines is not allowed. It will cause an error on the configuration file, resulting in invalid provisioning.

Configuration Parameters

- The maximum length of a parameter name is 32 characters.
- The maximum length of a parameter value is 500 characters excluding double quotation marks.
- No space characters are allowed in the line except when the value includes a space character(s).
Example:
`DISPLAY_NAME_PS1_1="John Smith" (valid)`
`DISPLAY_NAME_PS1_1 = "John Smith" (invalid)`
- Some parameter values can be specified as "empty" to set the parameter values to empty.
Example:
`NTP_ADDR=""`
- The parameters have no order.
- If the same parameter is specified in a configuration file more than once, the value specified first is applied.
- All configurable settings can be specified in the configuration file. You can ignore settings that already have the desired values. Only change parameters as necessary.

3.5 Configuration File Examples

The following examples of configuration files are provided on the Panasonic Web site (→ see **Introduction**).

- Simplified Example of the Configuration File
- Comprehensive Example of the Configuration File

3.5.1 Examples of Codec Settings

Setting the Codec Priority to (1)G.729A, (2)G.726-32, (3)PCMU, (4)G.722

```
## Codec Settings
# Enable G722
CODEC_ENABLE0_1="Y"
CODEC_PRIORITY0_1="4"
# Disable PCMA
CODEC_ENABLE1_1="N"
# Enable G726-32K
CODEC_ENABLE2_1="Y"
CODEC_PRIORITY2_1="2"
# Enable G729A
CODEC_ENABLE3_1="Y"
CODEC_PRIORITY3_1="1"
# Enable PCMU
CODEC_ENABLE4_1="Y"
CODEC_PRIORITY4_1="3"
```

Setting Narrow-band Codecs (PCMA, G.726-32 and G.729A)

```
## Codec Settings
# Disable G722
CODEC_ENABLE0_1="N"
# Enable PCMA
CODEC_ENABLE1_1="Y"
CODEC_PRIORITY1_1="1"
```

3.5.2 Example with Incorrect Descriptions

```
# Enable G726-32K
CODEC_ENABLE2_1="Y"
CODEC_PRIORITY2_1="1"
# Enable G729A
CODEC_ENABLE3_1="Y"
CODEC_PRIORITY3_1="1"
# Disable PCMU
CODEC_ENABLE4_1="N"
```

Setting the G.729A Codec Only

```
## Codec Settings
# Disable G722
CODEC_ENABLE0_1="N"
# Disable PCMA
CODEC_ENABLE1_1="N"
# Disable G726-32K
CODEC_ENABLE2_1="N"
# Enable G729A
CODEC_ENABLE3_1="Y"
CODEC_PRIORITY3_1="1"
# Disable PCMU
CODEC_ENABLE4_1="N"
# Do not set PCMU
CODEC_G711_REQ="0"
```

3.5.2 Example with Incorrect Descriptions

The following listing shows an example of a configuration file that contains incorrect formatting:

- ❶ An improper description is entered in the first line. A configuration file must start with the designated character sequence "# Panasonic SIP Phone Standard Format File #".
- ❷ Comment lines start in the middle of the lines.
- ❸ Space characters are inserted in the middle of the setting line.
- ❹ A specified value is not in the range allowed for that setting.

Incorrect Example

```
# This is a simplified sample configuration file. —❶

#####
# Configuration Setting #
#####
```

```

CFG_STANDARD_FILE_PATH="http://config.example.com/0123456789AB.cfg"
                                # URL of this configuration file

#####
# SIP Settings #
# Suffix "_1" indicates this parameter is for "line 1". #
#####

SIP_RGSTR_ADDR_1="registrar.example.com" # IP Address or FQDN of SIP registrar server
SIP_PRXY_ADDR_1="proxy.example.com"     # IP Address or FQDN of proxy server

# Enables DNS SRV lookup
SIP_DNSSRV_ENA_1="Y"

# ID, password for SIP authentication
SIP_AUTHID_1="SIP_User"
SIP_PASS_1="SIP_Password"

# Some Timer Settings #
# Expiration time of SIP registration; "1 hour"
REG_EXPIRE_TIME_1="3600"
# Disables SIP Session Timer (RFC 4028)
SIP_SESSION_TIME_1="0"

# DTMF will be sent through SDP, according to RFC 2833
OUTBANDDTMF_1="Y"

#####
# Call Control Settings #
#####

# Enables subscription to the Voice Mail server
VM_SUBSCRIBE_ENABLE="Y"

# Shared Call Settings
SHARED_CALL_ENABLE_1="Y"

# Disables Do Not Disturb, Call Forward synchronization.
FWD_DND_SYNCHRO_ENABLE_1="N"

```

②

③

④

3.5.2 Example with Incorrect Descriptions

Section 4

Configuration File Programming

This section provides information about the configuration parameters used in the configuration files.

4.1 General Information on the Configuration Files

4.1.1 Configuration File Parameters

The information on each parameter that can be written in a configuration file is shown in the tables in this section. The information includes parameter name (as the title of the table), value format, description, permitted value range, and the default value of each parameter. For details about corresponding Web user interface settings, see **2.1.3 Web User Interface Setting List**.

Parameter Name

This is the system-predefined parameter name and cannot be changed.

Note

- Certain parameter names end with suffixes indicating their type, as shown in the table below:

Type of Setting	Parameter Name
System setting	"..." or "...x"
SIP-CS setting	"..._CS" or "...x_CS"
S-PS setting	"..._PSy" or "...x_PSy"
S-PS setting per line	"..._PSy_n"

- "x" refers a number within the setting, for example, a button number.
- "y" refers to the S-PS number (1–255).
- "n" refers to the line number (S-PS: 1–2).

Value Format

Each parameter value is categorized into Integer, Boolean, or String. Some parameters require a composite form such as "Comma-separated Integer" or "Comma-separated String".

- Integer:** a numerical value, described as a sequence of numerical characters, optionally preceded by a "-" (minus)
An empty string is not allowed.
- Boolean:** "Y" or "N" ("Yes" or "No" also are allowed.)
- String:** sequence of alphanumerical characters
For details about available characters, see **4.1.2 Characters Available for String Values**.
- Comma-separated Integer:** a list of integers, separated by commas
No space characters are allowed.
- Comma-separated String:** a list of strings, separated by commas
No space characters are allowed.

Description

Describes the details of the parameter.

Value Range

Indicates the permitted value range of the parameter.

Default Value

Indicates the factory default value of the parameter.
Actual default values may vary depending on your dealer.

4.1.2 Characters Available for String Values

Unless noted otherwise in "Value Range", only ASCII characters can be used for parameter values. Unicode characters can also be used in some parameter values.

Available ASCII characters are shown on a white background in the following table:

	00	01	02	03	04	05	06	07	08	09	0A	0B	0C	0D	0E	0F
20	SP	!	"	#	\$	%	&	'	()	*	+	,	-	.	/
30	0	1	2	3	4	5	6	7	8	9	:	;	<	=	>	?
40	@	A	B	C	D	E	F	G	H	I	J	K	L	M	N	O
50	P	Q	R	S	T	U	V	W	X	Y	Z	[\]	^	_
60	`	a	b	c	d	e	f	g	h	i	j	k	l	m	n	o
70	p	q	r	s	t	u	v	w	x	y	z	{		}	~	

4.2 System Settings

4.2.1 Login Account Settings

ADMIN_ID

Value Format	String
Description	Specifies the account ID used to access the Web user interface with the Administrator account.
Value Range	Max. 16 characters (except ", &, ', :, <, >, and space) Note <ul style="list-style-type: none"> An empty string is not allowed.
Default Value	admin

ADMIN_PASS

Value Format	String
Description	Specifies the password to use to authenticate the Administrator account when logging in to the Web user interface.
Value Range	6–16 characters (except ", &, ', :, <, >, and space)
Default Value	adminpass

4.2.2 System Time Settings

USER_PASS_PSY

Value Format	String
Description	Specifies the password to use to authenticate the User account for Web user interface programming. Note <ul style="list-style-type: none">Although this setting is technically possible, you cannot log in to the Web user interface with the User account.
Value Range	6–16 characters (except ", &, ', :, <, >, and space)
Default Value	Empty string

4.2.2 System Time Settings

TIME_ZONE

Value Format	Integer
Description	Specifies the offset of local standard time from UTC (GMT), in minutes.
Value Range	-720–780 Note <ul style="list-style-type: none">Only the following values are available: -720 (GMT -12:00), -660 (GMT -11:00), -600 (GMT -10:00), -540 (GMT -09:00), -480 (GMT -08:00), -420 (GMT -07:00), -360 (GMT -06:00), -300 (GMT -05:00), -240 (GMT -04:00), -210 (GMT -03:30), -180 (GMT -03:00), -120 (GMT -02:00), -60 (GMT -01:00), 0 (GMT), 60 (GMT +01:00), 120 (GMT +02:00), 180 (GMT +03:00), 210 (GMT +03:30), 240 (GMT +04:00), 270 (GMT +04:30), 300 (GMT +05:00), 330 (GMT +05:30), 345 (GMT +05:45), 360 (GMT +06:00), 390 (GMT +06:30), 420 (GMT +07:00), 480 (GMT +08:00), 540 (GMT +09:00), 570 (GMT +09:30), 600 (GMT +10:00), 660 (GMT +11:00), 720 (GMT +12:00), 780 (GMT +13:00)If your location is west of Greenwich (0 [GMT]), the value should be minus. For example, the value for New York City, U.S.A. is "-300" (Eastern Standard Time being 5 hours behind GMT).This parameter is disabled when the "LOCAL_TIME_ZONE_POSIX" parameter is specified.
Default Value	0

DST_ENABLE

Value Format	Boolean
---------------------	---------

Description	Specifies whether to enable DST (Summer Time). Note <ul style="list-style-type: none"> This parameter is disabled when the "LOCAL_TIME_ZONE_POSIX" parameter is specified.
Value Range	<ul style="list-style-type: none"> Y (Enable DST [Summer Time]) N (Disable DST [Summer Time])
Default Value	N

DST_OFFSET

Value Format	Integer
Description	Specifies the amount of time, in minutes, to change the time when "DST_ENABLE" is set to "Y". Note <ul style="list-style-type: none"> This parameter is disabled when the "LOCAL_TIME_ZONE_POSIX" parameter is specified.
Value Range	0–720 Note <ul style="list-style-type: none"> This parameter is usually set to "60".
Default Value	60

DST_START_MONTH

Value Format	Integer
Description	Specifies the month in which DST (Summer Time) starts. Note <ul style="list-style-type: none"> This parameter is disabled when the "LOCAL_TIME_ZONE_POSIX" parameter is specified.
Value Range	1–12
Default Value	3

DST_START_ORDINAL_DAY

Value Format	Integer
---------------------	---------

4.2.2 System Time Settings

Description	<p>Specifies the number of the week on which DST (Summer Time) starts. The actual start day is specified in "DST_START_DAY_OF_WEEK". For example, to specify the second Sunday, specify "2" in this parameter, and "0" in the next parameter.</p> <p>Note</p> <ul style="list-style-type: none">This parameter is disabled when the "LOCAL_TIME_ZONE_POSIX" parameter is specified.
Value Range	<p>1–5</p> <ul style="list-style-type: none">– 1: the first week of the month– 2: the second week of the month– 3: the third week of the month– 4: the fourth week of the month– 5: the fifth week of the month
Default Value	2

DST_START_DAY_OF_WEEK

Value Format	Integer
Description	<p>Specifies the day of the week on which DST (Summer Time) starts.</p> <p>Note</p> <ul style="list-style-type: none">This parameter is disabled when the "LOCAL_TIME_ZONE_POSIX" parameter is specified.
Value Range	<p>0–6</p> <ul style="list-style-type: none">– 0: Sunday– 1: Monday– 2: Tuesday– 3: Wednesday– 4: Thursday– 5: Friday– 6: Saturday
Default Value	0

DST_START_TIME

Value Format	Integer
Description	<p>Specifies the start time of DST (Summer Time) in minutes after 12:00 AM.</p> <p>Note</p> <ul style="list-style-type: none">This parameter is disabled when the "LOCAL_TIME_ZONE_POSIX" parameter is specified.
Value Range	0–1439
Default Value	120

DST_STOP_MONTH

Value Format	Integer
Description	Specifies the month in which DST (Summer Time) ends. Note <ul style="list-style-type: none"> This parameter is disabled when the "LOCAL_TIME_ZONE_POSIX" parameter is specified.
Value Range	1–12
Default Value	10

DST_STOP_ORDINAL_DAY

Value Format	Integer
Description	Specifies the number of the week on which DST (Summer Time) ends. The actual end day is specified in "DST_STOP_DAY_OF_WEEK". For example, to specify the second Sunday, specify "2" in this parameter, and "0" in the next parameter. Note <ul style="list-style-type: none"> This parameter is disabled when the "LOCAL_TIME_ZONE_POSIX" parameter is specified.
Value Range	1–5 <ul style="list-style-type: none"> – 1: the first week of the month – 2: the second week of the month – 3: the third week of the month – 4: the fourth week of the month – 5: the fifth week of the month
Default Value	2

DST_STOP_DAY_OF_WEEK

Value Format	Integer
Description	Specifies the day of the week on which DST (Summer Time) ends. Note <ul style="list-style-type: none"> This parameter is disabled when the "LOCAL_TIME_ZONE_POSIX" parameter is specified.

4.2.2 System Time Settings

Value Range	0–6 <ul style="list-style-type: none"> – 0: Sunday – 1: Monday – 2: Tuesday – 3: Wednesday – 4: Thursday – 5: Friday – 6: Saturday
Default Value	0

DST_STOP_TIME

Value Format	Integer
Description	Specifies the end time of DST (Summer Time) in minutes after 12:00 AM. Note <ul style="list-style-type: none"> • This parameter is disabled when the "LOCAL_TIME_ZONE_POSIX" parameter is specified.
Value Range	0–1439
Default Value	120

LOCAL_TIME_ZONE_POSIX

Value Format	String
Description	Specifies a IEEE 1003.1 (POSIX)-compliant local time zone definition (e.g., "EST+5:00:00EDT+4:00:00,M4.1.0/2:00:00,M10.5.0/2:00:00"). Note <ul style="list-style-type: none"> • If this parameter is specified, the following parameters are disabled, and operation will be based on this parameter. <ul style="list-style-type: none"> – TIME_ZONE – DST_ENABLE – DST_OFFSET – DST_START_MONTH – DST_START_ORDINAL_DAY – DST_START_DAY_OF_WEEK – DST_START_TIME – DST_STOP_MONTH – DST_STOP_ORDINAL_DAY – DST_STOP_DAY_OF_WEEK – DST_STOP_TIME
Value Range	Max. 70 characters
Default Value	Empty string

4.2.3 Syslog Settings

SYSLOG_EVENT_SIP

Value Format	Integer
Description	Specifies which SIP-related syslog events are sent to the syslog server. Note <ul style="list-style-type: none"> If the level of the event is higher than or equal to the set value, the log is sent to the syslog server.
Value Range	0–6 <ul style="list-style-type: none"> – 0: no logs sent – 1: emergency (highest) – 2: alert – 3: critical – 4: error – 5: warning – 6: information (lowest)
Default Value	0

SYSLOG_EVENT_CFG

Value Format	Integer
Description	Specifies the threshold of syslog events regarding configuration.
Value Range	0–6
Default Value	0

SYSLOG_EVENT_VOIP

Value Format	Integer
Description	Specifies the threshold of syslog events regarding VoIP operation.
Value Range	0–6
Default Value	0

SYSLOG_EVENT_TEL

Value Format	Integer
Description	Specifies the threshold of syslog events regarding telephone functions. Note <ul style="list-style-type: none"> This setting is not applicable for the current version. No logs will be sent to the syslog server, even if values "1–6" are specified.

4.2.4 Firmware Update Settings

Value Range	0–6
Default Value	0

SYSLOG_ADDR

Value Format	String
Description	Specifies the IP address or FQDN of the syslog server.
Value Range	Max. 127 characters (IP address in dotted-decimal notation or FQDN)
Default Value	Empty string

SYSLOG_PORT

Value Format	Integer
Description	Specifies the port number of the syslog server.
Value Range	1–65535
Default Value	514

SYSLOG_RTPSMLY_INTVL

Value Format	Integer
Description	Specifies the interval, in seconds, to send summarized information of RTP packets to the syslog server.
Value Range	0, 5–65535 (0: No information sent)
Default Value	20

4.2.4 Firmware Update Settings

FIRM_UPGRADE_ENABLE

Value Format	Boolean
Description	<p>Specifies whether to perform firmware updates when the SIP-CS detects a newer version of firmware.</p> <p>Note</p> <ul style="list-style-type: none">• Changing this setting may require restarting the SIP-CS.• Local firmware updates from the Web user interface (→ see 2.7.4 All Firmware Update) can be performed regardless of this setting.• Firmware updates using TR-069 can be performed regardless of this setting.

Value Range	<ul style="list-style-type: none"> • Y (Enable firmware updates) • N (Disable firmware updates)
Default Value	Y

FIRM_VERSION

Value Format	String
Description	<p>Specifies the firmware version of the SIP-CS.</p> <p>Note</p> <ul style="list-style-type: none"> • Changing this setting may require restarting the SIP-CS.
Value Range	00.000–15.999
Default Value	Empty string

PS_FIRM_UPGRADE_AUTO

Value Format	Boolean
Description	<p>Specifies whether to perform the S-PS firmware update automatically when the S-PS detects a newer version of firmware or to disable automatic firmware update. If "N" is selected, the "Firmware Update" menu appears in the S-PS's "Setting Handset" → "System Option" menu.</p> <p>Note</p> <ul style="list-style-type: none"> • This setting is available only when "FIRM_UPGRADE_ENABLE" is set to "Y". • Changing this setting may require restarting the SIP-CS.
Value Range	<ul style="list-style-type: none"> • Y (Enable automatic firmware update and hide S-PS firmware update menu) • N (Disable automatic firmware update and show S-PS firmware update menu)
Default Value	Y

FIRM_FILE_PATH

Value Format	String
Description	<p>Specifies the URL where the firmware file is stored.</p> <p>Note</p> <ul style="list-style-type: none"> • This setting is available only when "FIRM_UPGRADE_ENABLE" is set to "Y". • Changing this setting may require restarting the SIP-CS.

4.2.5 Provisioning Settings

Value Range	<p>Max. 500 characters</p> <p>Note</p> <ul style="list-style-type: none"> The format must be RFC 1738 compliant, as follows: "<code><scheme>://<user>:<password>@<host>:<port>/<url-path></code>". <ul style="list-style-type: none"> "<code><user></code>" must be less than 128 characters. "<code><password></code>" must be less than 128 characters. "<code><user>:<password>@</code>" may be empty. The total of "<code><scheme>://</code>" and "<code><host>:<port>/<url-path></code>" must be less than 245 characters. "<code><port></code>" can be omitted if you do not need to specify the port number. If "<code>{mac}</code>" is included in this URL, it will be replaced with the SIP-CS's MAC address in lower-case. If "<code>{MAC}</code>" is included in this URL, it will be replaced with the SIP-CS's MAC address in upper-case. If "<code>{MODEL}</code>" is included in this URL, it will be replaced with the SIP-CS's model name. If "<code>{fwver}</code>" is included in this URL, it will be replaced with "<code>FIRM_VERSION</code>" depending on the system. Note that this rule differs from other parameters such as "<code>SIP_USER_AGENT</code>".
Default Value	Empty string

4.2.5 Provisioning Settings

OPTION66_ENABLE

Value Format	Boolean
Description	<p>Specifies whether to enable the SIP-CS to look for option 66 to receive the TFTP server address or FQDN from the DHCP server.</p> <p>Note</p> <ul style="list-style-type: none"> The SIP-CS will try to download configuration files through the TFTP server, the IP address or FQDN of which is specified in the option number 66 field.
Value Range	<ul style="list-style-type: none"> Y (Enable option 66) N (Disable option 66)
Default Value	Y

OPTION66_REBOOT

Value Format	Boolean
Description	<p>Specifies whether the SIP-CS restarts automatically after pre-provisioning has completed successfully using DHCP server option 66. For details, see 3.1.4 Pre-provisioning Setting Example.</p>

Value Range	<ul style="list-style-type: none"> • Y (Restart automatically) • N (Do not restart automatically)
Default Value	N

PROVISION_ENABLE

Value Format	Boolean
Description	<p>Specifies whether the SIP-CS is automatically configured by downloading the configuration files from the provisioning server of your phone system.</p> <p>Note</p> <ul style="list-style-type: none"> • Downloading configuration files using TR-069 can be performed regardless of this setting.
Value Range	<ul style="list-style-type: none"> • Y (Enable configuration file download) • N (Disable configuration file download)
Default Value	Y

CFG_STANDARD_FILE_PATH

Value Format	String
Description	<p>Specifies the URL of the standard configuration file, which is used when every SIP-CS needs different settings.</p> <p>Note</p> <ul style="list-style-type: none"> • When you change this setting, set "PROVISION_ENABLE" to "Y" at the same time.

4.2.5 Provisioning Settings

Value Range	<p>Max. 500 characters</p> <p>Note</p> <ul style="list-style-type: none"> The format must be RFC 1738 compliant, as follows: "<code><scheme>://<user>:<password>@<host>:<port>/<url-path></code>" <ul style="list-style-type: none"> "<code><user></code>" must be less than 128 characters. "<code><password></code>" must be less than 128 characters. "<code><user>:<password>@</code>" may be empty. The total of "<code><scheme>://</code>" and "<code><host>:<port>/<url-path></code>" must be less than 245 characters. "<code>:<port></code>" can be omitted if you do not need to specify the port number. If "<code>{mac}</code>" is included in this URL, it will be replaced with the SIP-CS's MAC address in lower-case. If "<code>{MAC}</code>" is included in this URL, it will be replaced with the SIP-CS's MAC address in upper-case. If "<code>{MODEL}</code>" is included in this URL, it will be replaced with the SIP-CS's model name. If "<code>{fwver}</code>" is included in this URL, it will be replaced with the SIP-CS's firmware version. If this URL ends with "/" (slash), "Config<code>{mac}</code>.cfg" is automatically added at the end of the URL. For example, <code>CFG_STANDARD_FILE_PATH="http://host/dir/"</code> becomes <code>CFG_STANDARD_FILE_PATH="http://host/dir/Config{mac}.cfg"</code>.
Default Value	<p>http://provisioning.e-connecting.net/redirect/conf/{mac}.cfg</p>

CFG_PRODUCT_FILE_PATH

Value Format	<p>String</p>
Description	<p>Specifies the URL of the product configuration file, which is used when all SIP-CSs with the same model number need the same settings.</p> <p>Note</p> <ul style="list-style-type: none"> When you change this setting, set "<code>PROVISION_ENABLE</code>" to "<code>Y</code>" at the same time.

Value Range	<p>Max. 500 characters</p> <p>Note</p> <ul style="list-style-type: none"> The format must be RFC 1738 compliant, as follows: <ul style="list-style-type: none"> "<scheme>://<user>:<password>@<host>:<port>/<url-path>" <ul style="list-style-type: none"> "<user>" must be less than 128 characters. "<password>" must be less than 128 characters. "<user>:<password>@" may be empty. The total of "<scheme>://" and "<host>:<port>/<url-path>" must be less than 245 characters. ":<port>" can be omitted if you do not need to specify the port number. If "{mac}" is included in this URL, it will be replaced with the SIP-CS's MAC address in lower-case. If "{MAC}" is included in this URL, it will be replaced with the SIP-CS's MAC address in upper-case. If "{MODEL}" is included in this URL, it will be replaced with the SIP-CS's model name. If "{fwver}" is included in this URL, it will be replaced with the SIP-CS's firmware version. If this URL ends with "/" (slash), "{MODEL}.cfg" is automatically added at the end of the URL. For example, <code>CFG_PRODUCT_FILE_PATH="http://host/dir/"</code> becomes <code>CFG_PRODUCT_FILE_PATH="http://host/dir/{MODEL}.cfg"</code>.
Default Value	<p>Empty string</p> <p>Note</p> <ul style="list-style-type: none"> The URL specified by your dealer may be preset in the SIP-CS.

CFG_MASTER_FILE_PATH

Value Format	String
Description	<p>Specifies the URL of the master configuration file, which is used when all SIP-CSs need the same settings.</p> <p>Note</p> <ul style="list-style-type: none"> When you change this setting, set "PROVISION_ENABLE" to "y" at the same time.

4.2.5 Provisioning Settings

<p>Value Range</p>	<p>Max. 500 characters</p> <p>Note</p> <ul style="list-style-type: none"> The format must be RFC 1738 compliant, as follows: "<code><scheme>://<user>:<password>@<host>:<port>/<url-path></code>" <ul style="list-style-type: none"> "<code><user></code>" must be less than 128 characters. "<code><password></code>" must be less than 128 characters. "<code><user>:<password>@</code>" may be empty. The total of "<code><scheme>://</code>" and "<code><host>:<port>/<url-path></code>" must be less than 245 characters. "<code>:<port></code>" can be omitted if you do not need to specify the port number. If "<code>{mac}</code>" is included in this URL, it will be replaced with the SIP-CS's MAC address in lower-case. If "<code>{MAC}</code>" is included in this URL, it will be replaced with the SIP-CS's MAC address in upper-case. If "<code>{MODEL}</code>" is included in this URL, it will be replaced with the SIP-CS's model name. If "<code>{fwver}</code>" is included in this URL, it will be replaced with the SIP-CS's firmware version. If this URL ends with "/" (slash), "sip.cfg" is automatically added at the end of the URL. For example, <code>CFG_MASTER_FILE_PATH="http://host/dir/"</code> becomes <code>CFG_MASTER_FILE_PATH="http://host/dir/sip.cfg"</code>.
<p>Default Value</p>	<p>Empty string</p> <p>Note</p> <ul style="list-style-type: none"> The URL specified by your dealer may be preset in the SIP-CS.

CFG_SYSTEM_FILE_PATH

<p>Value Format</p>	<p>String</p>
<p>Description</p>	<p>Specifies the URL of the system configuration file, which is used when the whole system needs the same settings.</p> <p>Note</p> <ul style="list-style-type: none"> When you change this setting, set "<code>PROVISION_ENABLE</code>" to "<code>Y</code>" at the same time.

Value Range	<p>Max. 500 characters</p> <p>Note</p> <ul style="list-style-type: none"> The format must be RFC 1738 compliant, as follows: <ul style="list-style-type: none"> "<scheme>://<user>:<password>@<host>:<port>/<url-path>" <ul style="list-style-type: none"> "<user>" must be less than 128 characters. "<password>" must be less than 128 characters. "<user>:<password>@" may be empty. The total of "<scheme>://" and "<host>:<port>/<url-path>" must be less than 245 characters. ":<port>" can be omitted if you do not need to specify the port number. If "{mac}" is included in this URL, it will be replaced with the SIP-CS's MAC address in lower-case. If "{MAC}" is included in this URL, it will be replaced with the SIP-CS's MAC address in upper-case. If "{MODEL}" is included in this URL, it will be replaced with the SIP-CS's model name. If "{fwver}" is included in this URL, it will be replaced with the SIP-CS's firmware version. If this URL ends with "/" (slash), "system.cfg" is automatically added at the end of the URL. For example, <code>CFG_SYSTEM_FILE_PATH="http://host/dir/"</code> becomes <code>CFG_SYSTEM_FILE_PATH="http://host/dir/system.cfg"</code>.
Default Value	<p>Empty string</p> <p>Note</p> <ul style="list-style-type: none"> The URL specified by your dealer may be preset in the SIP-CS.

CFG_FILE_KEY1

Value Format	String
Description	<p>Specifies the encryption key (password) used to decrypt configuration files.</p> <p>Note</p> <ul style="list-style-type: none"> If the extension of the configuration file is ".e1c", the configuration file will be decrypted using this key.
Value Range	<p>32-byte characters</p> <p>Note</p> <ul style="list-style-type: none"> If an empty string is set for this parameter, decryption with this value is disabled.
Default Value	A unique value is preset to each SIP-CS and S-PS.

CFG_FILE_KEY2

Value Format	String
Description	Specifies the encryption key (password) used to decrypt configuration files. Note <ul style="list-style-type: none"> If the extension of the configuration file is ".e2c", the configuration file will be decrypted using this key.
Value Range	32-byte characters Note <ul style="list-style-type: none"> If an empty string is set for this parameter, decryption with this value is disabled.
Default Value	Empty string

CFG_FILE_KEY3

Value Format	String
Description	Specifies the encryption key (password) used to decrypt configuration files. Note <ul style="list-style-type: none"> If the extension of the configuration file is ".e3c", the configuration file will be decrypted using this key.
Value Range	32-byte characters Note <ul style="list-style-type: none"> If an empty string is set for this parameter, decryption with this value is disabled.
Default Value	Empty string

CFG_FILE_KEY4

Value Format	String
Description	Specifies the encryption key (password) used to decrypt configuration files. Note <ul style="list-style-type: none"> If the extension of the configuration file is ".e4c", the configuration file will be decrypted using this key.
Value Range	32-byte characters Note <ul style="list-style-type: none"> If an empty string is set for this parameter, decryption with this value is disabled.

Default Value	Empty string
---------------	--------------

CFG_FILE_KEY_LENGTH

Value Format	Integer
Description	Specifies the key lengths in bits used to decrypt configuration files.
Value Range	128
Default Value	128 (fixed)

CFG_CYCLIC

Value Format	Boolean
Description	Specifies whether the SIP-CS periodically checks for updates of configuration files.
Value Range	<ul style="list-style-type: none"> • Y (Enable periodic synchronization of configuration files) • N (Disable periodic synchronization of configuration files)
Default Value	N

CFG_CYCLIC_INTVL

Value Format	Integer
Description	Specifies the interval, in minutes, between periodic checks for updates of the configuration files.
Value Range	1–40320
Default Value	10080

CFG_RTRY_INTVL

Value Format	Integer
Description	<p>Specifies the period of time, in minutes, that the SIP-CS will retry checking for an update of the configuration files after a configuration file access error has occurred.</p> <p>Note</p> <ul style="list-style-type: none"> • This setting is available only when "CFG_CYCLIC" is set to "Y".
Value Range	1–1440
Default Value	30

CFG_RESYNC_TIME

Value Format	String
Description	Specifies the time (hour:minute) that the SIP-CS checks for updates of configuration files.
Value Range	00:00–23:59 Note <ul style="list-style-type: none"> If the value for this setting is any valid value other than an empty string, the SIP-CS downloads the configuration files at the fixed time, and the settings specified in "CFG_CYCLIC", "CFG_CYCLIC_INTVL", and "CFG_RTRY_INTVL" are disabled. If the value for this setting is an empty string, downloading the configuration files at the fixed time are disabled.
Default Value	Empty string

CFG_RESYNC_FROM_SIP

Value Format	String
Description	Specifies the value of the "Event" header sent from the SIP server to the SIP-CS so that the SIP-CS can access the configuration files on the provisioning server.
Value Range	Max. 15 characters Note <ul style="list-style-type: none"> An empty string is not allowed.
Default Value	check-sync

4.2.6 Other Settings

IPEI_PSy

Value Format	String
Description	Specifies the S-PS's IPEI, which is used when registering the S-PS to the SIP-CS.
Value Range	12 digits
Default Value	Empty string

SIP_REGI_PS_LIMIT

Value Format	Integer
---------------------	---------

Description	Specifies the number of S-PSs (SIP server accounts) per SIP-CS. Configure this setting referring to the expire time for SIP registration in the table below. <table border="1" data-bbox="657 432 1442 763"> <thead> <tr> <th>Expire time (in seconds)</th> <th>Number of S-PSs (1 account)</th> <th>Number of S-PSs (2 accounts)</th> </tr> </thead> <tbody> <tr> <td>20</td> <td>32</td> <td>16</td> </tr> <tr> <td>30</td> <td>64</td> <td>32</td> </tr> <tr> <td>360</td> <td>192</td> <td>96</td> </tr> <tr> <td>480</td> <td>255</td> <td>128</td> </tr> <tr> <td>960</td> <td>255</td> <td>255</td> </tr> </tbody> </table>	Expire time (in seconds)	Number of S-PSs (1 account)	Number of S-PSs (2 accounts)	20	32	16	30	64	32	360	192	96	480	255	128	960	255	255
Expire time (in seconds)	Number of S-PSs (1 account)	Number of S-PSs (2 accounts)																	
20	32	16																	
30	64	32																	
360	192	96																	
480	255	128																	
960	255	255																	
Value Range	1–255																		
Default Value	32																		

PROVISION_SUPERMASTER_ONLY

Value Format	Boolean
Description	Specifies whether only the Super Master CS or all SIP-CSs can perform provisioning.
Value Range	<ul style="list-style-type: none"> Y (Only the Super Master CS can perform provisioning.) N (All SIP-CSs can perform provisioning.) <p>Note</p> <ul style="list-style-type: none"> When "Y" is selected, after downloading the configuration file, the Super Master CS distributes it to all other SIP-CSs.
Default Value	N

PS_FIRM_UPGRADE_MODE

Value Format	String
Description	Specifies the download mode of S-PS firmware.
Value Range	<ul style="list-style-type: none"> UP (Download S-PS firmware for upgrades only.) DOWN (Download S-PS firmware for downgrades only.) UP/DOWN (Download S-PS firmware for upgrades and downgrades.)
Default Value	UP

4.3 Network Settings

4.3.1 IP Settings

CONNECTION_TYPE

Value Format	Integer
Description	Specifies whether to assign the IP address automatically (DHCP) or manually (static).
Value Range	<ul style="list-style-type: none"> • 1 (DHCP) • 0 (Static)
Default Value	1

HOST_NAME

Value Format	String
Description	<p>Specifies the host name for the SIP-CS to send to the DHCP server.</p> <p>Note</p> <ul style="list-style-type: none"> • This setting is available only when "CONNECTION_TYPE" is set to "1".
Value Range	<p>Max. 63 characters</p> <p>Note</p> <ul style="list-style-type: none"> • An empty string is not allowed. • If "{MODEL}" is included in this parameter, it will be replaced with the SIP-CS's model name.
Default Value	{MODEL}

DHCP_DNS_ENABLE

Value Format	Boolean
Description	<p>Specifies whether to receive DNS server addresses automatically or to assign a DNS server addresses (up to 2) manually.</p> <p>Note</p> <ul style="list-style-type: none"> • This setting is available only when "CONNECTION_TYPE" is set to "1".
Value Range	<ul style="list-style-type: none"> • Y (Use "USER_DNS1_ADDR" or, "USER_DNS1_ADDR" and "USER_DNS2_ADDR") • N (Receive DNS server address automatically)
Default Value	N

STATIC_IP_ADDRESS

Value Format	String
Description	Specifies the IP address for the SIP-CS. Note <ul style="list-style-type: none"> • This setting is available only when "CONNECTION_TYPE" is set to "0". • When you specify this parameter, you must specify "STATIC_SUBNET" together in a configuration file.
Value Range	IP address in dotted-decimal notation
Default Value	Empty string

STATIC_SUBNET

Value Format	String
Description	Specifies the subnet mask for the SIP-CS. Note <ul style="list-style-type: none"> • This setting is available only when "CONNECTION_TYPE" is set to "0". • When you specify this parameter, you must specify "STATIC_IP_ADDRESS" together in a configuration file.
Value Range	IP address in dotted-decimal notation
Default Value	Empty string

STATIC_GATEWAY

Value Format	String
Description	Specifies the IP address of the default gateway for the network where the SIP-CS is connected. Note <ul style="list-style-type: none"> • This setting is available only when "CONNECTION_TYPE" is set to "0". • When you specify this parameter, you must specify "STATIC_IP_ADDRESS" and "STATIC_SUBNET" together in a configuration file.
Value Range	IP address in dotted-decimal notation
Default Value	Empty string

USER_DNS1_ADDR

Value Format	String
Description	Specifies the IP address of the primary DNS server. Note <ul style="list-style-type: none"> This setting is available only when "CONNECTION_TYPE" is set to "0".
Value Range	IP address in dotted-decimal notation
Default Value	Empty string

USER_DNS2_ADDR

Value Format	String
Description	Specifies the IP address of the secondary DNS server. Note <ul style="list-style-type: none"> This setting is available only when "CONNECTION_TYPE" is set to "0".
Value Range	IP address in dotted-decimal notation
Default Value	Empty string

4.3.2 DNS Settings**DNS_QRY_PRL**

Value Format	Boolean
Description	Specifies the DNS query method as parallel or sequential.
Value Range	<ul style="list-style-type: none"> Y (Parallel) N (Sequential) Note <ul style="list-style-type: none"> If set to "Y", the SIP-CS sends out all DNS queries at the same time. The first DNS reply will be accepted and used by the SIP-CS. If set to "N", the SIP-CS sends DNS queries sequentially. The SIP-CS sends a request to the DNS server with the highest priority for a preprogrammed time period (5 seconds). When the timer expires, the SIP-CS sends a request to the DNS server with the second priority.
Default Value	Y

DNS_PRIORITY

Value Format	Boolean
Description	Specifies the priority of the DNS server.
Value Range	<ul style="list-style-type: none"> • Y ("DNS1_ADDR" and "DNS2_ADDR" have first priority.) • N ("DNS1_ADDR" and "DNS2_ADDR" have no priority.) <p>Note</p> <ul style="list-style-type: none"> • If set to "Y", the DNS servers specified in "DNS1_ADDR" and "DNS2_ADDR" will be queried first. If the queries fail, the DNS server specified by the user (DHCP or static) will be queried. • If set to "N", the DNS server specified by the user (DHCP or static) will be queried first. If the query fails, the DNS servers specified in "DNS1_ADDR" and "DNS2_ADDR" will be queried.
Default Value	N

DNS1_ADDR

Value Format	String
Description	Specifies the IP address of the primary DNS server for your dealer.
Value Range	IP address in dotted-decimal notation
Default Value	Empty string

DNS2_ADDR

Value Format	String
Description	Specifies the IP address of the secondary DNS server for your dealer.
Value Range	IP address in dotted-decimal notation
Default Value	Empty string

4.3.3 Ethernet Port Settings

LLDP_ENABLE

Value Format	Boolean
Description	Selects whether to enable or disable sending and receiving LLDP frames.
Value Range	<ul style="list-style-type: none"> • Y (Enable) • N (Disable)
Default Value	Y

4.3.4 HTTP Settings

LLDP_INTERVAL

Value Format	Integer
Description	Specifies the interval, in seconds, between sending each LLDP frame.
Value Range	1–3600
Default Value	30

VLAN_ENABLE

Value Format	Boolean
Description	Specifies whether to use the VLAN feature to perform VoIP communication securely.
Value Range	<ul style="list-style-type: none">Y (Enable)N (Disable)
Default Value	N

VLAN_ID_IP_PHONE

Value Format	Integer
Description	Specifies the VLAN ID for this SIP-CS.
Value Range	1–4094
Default Value	2

VLAN_PRI_IP_PHONE

Value Format	Integer
Description	Specifies the priority number for the SIP-CS.
Value Range	0–7
Default Value	7

4.3.4 HTTP Settings

HTTPD_PORTOPEN_AUTO

Value Format	Boolean
Description	Specifies whether the SIP-CS's Web port is always open.

Value Range	<ul style="list-style-type: none"> • Y (Web port is always open) • N (Web port must be opened manually) <p>Notice</p> <ul style="list-style-type: none"> • If you want to set to "Y", please fully recognize the possibility of unauthorized access to the SIP-CS through the Web user interface and change this setting at your own risk. In addition, please take full security measures for connecting to an external network and control all passwords for logging in to the Web user interface.
Default Value	N

HTTP_VER

Value Format	Integer
Description	Specifies which version of the HTTP protocol to use for HTTP communication.
Value Range	<ul style="list-style-type: none"> • 1 (Use HTTP 1.0) • 0 (Use HTTP 1.1) <p>Note</p> <ul style="list-style-type: none"> • For this SIP-CS, it is strongly recommended that you specify "1" for this setting. However, if the HTTP server does not function well with HTTP 1.0, try changing the setting "0".
Default Value	1

HTTP_USER_AGENT

Value Format	String
Description	Specifies the text string to send as the user agent in the header of HTTP requests.
Value Range	<p>Max. 40 characters</p> <p>Note</p> <ul style="list-style-type: none"> • An empty string is not allowed. • If "{mac}" is included in this parameter, it will be replaced with the SIP-CS's MAC address in lower-case. • If "{MAC}" is included in this parameter, it will be replaced with the SIP-CS's MAC address in upper-case. • If "{MODEL}" is included in this parameter, it will be replaced with the SIP-CS's model name. • If "{fwver}" is included in this parameter, it will be replaced with the firmware version of the SIP-CS.
Default Value	Panasonic_{MODEL}/{fwver} ({mac})

HTTP_SSL_VERIFY

Value Format	Integer
Description	Specifies whether to enable the verification of the root certificate.
Value Range	<ul style="list-style-type: none"> • 0 (No verification of root certificate) • 1 (Simple verification of root certificate) • 2 (Precise verification of root certificate) <p>Note</p> <ul style="list-style-type: none"> • If set to "0", the verification of the root certificate is disabled. • If set to "1", the verification of the root certificate is enabled. In this case, the validity of the certificate's date, certificate's chain, and the confirmation of the root certificate will be verified. • If set to "2", precise certificate verification is enabled. In this case, the validity of the server name will be verified in addition to the items verified when "1" is set. • If the SIP-CS has not obtained the current time, verification will not be performed irrelevant of this setting. In order to perform verification it is necessary to first set up the NTP server.
Default Value	0

CFG_ROOT_CERTIFICATE_PATH

Value Format	String
Description	Specifies the URI of the root certificate. Note <ul style="list-style-type: none"> • Changing this setting may require restarting the SIP-CS.
Value Range	Max. 500 characters Note <ul style="list-style-type: none"> • The format must be RFC 1738 compliant, as follows: "<scheme>://<user>:<password>@<host>:<port>/<url-path>" <ul style="list-style-type: none"> – "<user>" must be less than 128 characters. – "<password>" must be less than 128 characters. – "<user>:<password>@" may be empty. – The total of "<scheme>://" and "<host>:<port>/<url-path>" must be less than 245 characters. – ":<port>" can be omitted if you do not need to specify the port number.
Default Value	Empty string

4.3.5 Time Adjust Settings

NTP_ADDR

Value Format	String
Description	Specifies the IP address or FQDN of the NTP server.
Value Range	Max. 127 characters (IP address in dotted-decimal notation or FQDN)
Default Value	Empty string

TIME_SYNC_INTVL

Value Format	Integer
Description	Specifies the interval, in seconds, to resynchronize after having detected no reply from the NTP server.
Value Range	10–86400
Default Value	60

TIME_QUERY_INTVL

Value Format	Integer
Description	Specifies the interval, in seconds, between synchronizations with the NTP server.
Value Range	10–86400
Default Value	43200

4.3.6 STUN Settings

STUN_SERV_ADDR

Value Format	String
Description	Specifies the IP address or FQDN of the STUN server.
Value Range	Max. 127 characters (IP address in dotted-decimal notation or FQDN)
Default Value	Empty string

STUN_SERV_PORT

Value Format	Integer
Description	Specifies the port number of the STUN server.
Value Range	1–65535

4.4.1 Call Control Settings

Default Value	3478
---------------	------

STUN_2NDSERV_ADDR

Value Format	String
Description	Specifies the IP address of the secondary STUN server. Note <ul style="list-style-type: none">This setting is available only when "STUN_SERV_ADDR" is specified in IP address notation.
Value Range	Max. 127 characters (IP address in dotted-decimal notation or FQDN)
Default Value	Empty string

STUN_2NDSERV_PORT

Value Format	Integer
Description	Specifies the port number of the secondary STUN server.
Value Range	1–65535
Default Value	3478

4.4 Telephone Settings

4.4.1 Call Control Settings

VM_SUBSCRIBE_ENABLE

Value Format	Boolean
Description	Specifies whether to send the SUBSCRIBE request to a voice mail server. Note <ul style="list-style-type: none">Your phone system must support voice mail.
Value Range	<ul style="list-style-type: none">Y (Send the SUBSCRIBE request)N (Do not send the SUBSCRIBE request)
Default Value	N

CONFERENCE_SERVER_URI

Value Format	String
--------------	--------

Description	Specifies the URI for a conference server, which consists of "sip:", a user part, the "@" symbol, and a host part, for example, "sip:conference@example.com". Note <ul style="list-style-type: none"> In a SIP URI, the user part ("conference" in the example above) can contain up to 63 characters, and the host part ("example.com" in the example above) can contain up to 127 characters. Availability depends on your phone system.
Value Range	Max. 195 characters (except ", &, ', :, ;, <, >, and space)
Default Value	Empty string

FIRSTDIGIT_TIM

Value Format	Integer
Description	Specifies the length of time, in seconds, within which the first digits of a dial number must be dialed. When this timer expires, the SIP-CS will play a busy tone.
Value Range	1–600
Default Value	30

INTDIGIT_TIM

Value Format	Integer
Description	Specifies the length of time, in seconds, within which subsequent digits of a dial number must be dialed. When this timer expires after the last key was pressed, dialing will start.
Value Range	1–15
Default Value	5

MACRODIGIT_TIM

Value Format	Integer
Description	Specifies the length of time, in seconds, that the SIP-CS waits when a "T" or "t" has been entered in the dial plan.
Value Range	1–15
Default Value	5

INTERNATIONAL_ACCESS_CODE

Value Format	String
Description	Specifies the number to be shown in the place of the first "+" symbol when the phone number for incoming international calls contains "+".
Value Range	Max. 8 characters (consisting of 0–9, *, and #) Note <ul style="list-style-type: none"> No other characters are allowed.
Default Value	Empty string ("+" is deleted)

COUNTRY_CALLING_CODE

Value Format	String
Description	Specifies the country/area calling code to be used for comparative purposes when dialing a number from the incoming call log that contains a "+" symbol.
Value Range	Max. 8 characters (consisting of 0–9)
Default Value	Empty string

NATIONAL_ACCESS_CODE

Value Format	String
Description	When dialing a number from the incoming call log that contains a "+" symbol and the country calling code matches, the country calling code is removed and the national access code is added.
Value Range	Max. 8 characters (consisting of 0–9, *, and #)
Default Value	Empty string

DEFAULT_LINE_SELECT_PSy

Value Format	Integer
Description	Specifies the line used to make an outgoing call when no line is specified in the dialing operation.
Value Range	1–2
Default Value	1

HOLD_RECALL_TIM

Value Format	Integer
---------------------	---------

Description	Specifies the duration of the hold recall timer. If set to "0", the function is disabled.
Value Range	0–240 (0: Disable)
Default Value	60

AUTO_CALL_HOLD

Value Format	Boolean
Description	Selects whether calls are disconnected or held when a DN button is pressed while having a conversation.
Value Range	<ul style="list-style-type: none"> • Y (Enable Auto Call Hold) • N (Disable Auto Call Hold)
Default Value	N

DISCONNECTION_MODE

Value Format	Integer
Description	Selects the tone heard (reorder tone or busy tone) when a dial operation fails.
Value Range	1–2 – 1: Mode1 (ROT) – 2: Mode2 (BT)
Default Value	1

TONE_LEN_DISCONNECT_HANDSFREE

Value Format	Integer
Description	Specifies the duration, in seconds, that a disconnect tone will be heard when the other party ends a call. This setting applies to both Receiver mode and Hands-free mode.
Value Range	1–15
Default Value	3

4.4.2 Tone Settings

DIAL_TONE1_FRQ

Value Format	Comma-separated Integer
Description	Specifies the dual-tone frequencies, in hertz, of Dial Tone 1 using 2 whole numbers separated by a comma.

4.4.2 Tone Settings

Value Range	0, 200–2000 (0: No tone)
Default Value	350,440

DIAL_TONE1_GAIN

Value Format	Integer
Description	Specifies the gain, in decibels, of Dial Tone 1.
Value Range	-24–6
Default Value	0

DIAL_TONE1_RPT

Value Format	Integer
Description	Specifies whether Dial Tone 1 is repeated.
Value Range	0–1 – 0: No Repeat – 1: Repeat
Default Value	0

DIAL_TONE1_TIMING

Value Format	Comma-separated Integer
Description	Specifies the pattern, in milliseconds, of Dial Tone 1 using up to 10 whole numbers (off 1, on 1, off 2, on 2...) separated by commas. Note <ul style="list-style-type: none">• It is recommended that you set a value of 60 milliseconds or more for the first value (off 1).• Avoid setting 1–50 for any of the values.
Value Range	0–16000 (0: Infinite time)
Default Value	60,0

DIAL_TONE2_FRQ

Value Format	Comma-separated Integer
Description	Specifies the dual-tone frequencies, in hertz, of Dial Tone 2 using 2 whole numbers separated by a comma.
Value Range	0, 200–2000 (0: No tone)
Default Value	350,440

DIAL_TONE2_GAIN

Value Format	Integer
Description	Specifies the gain, in decibels, of Dial Tone 2.
Value Range	-24–6
Default Value	0

DIAL_TONE2_RPT

Value Format	Integer
Description	Specifies whether Dial Tone 2 is repeated.
Value Range	0–1 – 0: No Repeat – 1: Repeat
Default Value	0

DIAL_TONE2_TIMING

Value Format	Comma-separated Integer
Description	Specifies the pattern, in milliseconds, of Dial Tone 2 using up to 10 whole numbers (off 1, on 1, off 2, on 2...) separated by commas. Note <ul style="list-style-type: none"> It is recommended that you set a value of 60 milliseconds or more for the first value (off 1). Avoid setting 1–50 for any of the values.
Value Range	0–16000 (0: Infinite time)
Default Value	60,0

DIAL_TONE4_FRQ

Value Format	Comma-separated Integer
Description	Specifies the dual-tone frequencies, in hertz, of Dial Tone 4 (stutter dial tones) to notify that a voice mail is waiting, using 2 whole numbers separated by a comma.
Value Range	0, 200–2000 (0: No tone)
Default Value	350,440

BUSY_TONE_GAIN

Value Format	Integer
Description	Specifies the gain, in decibels, of the busy tone.
Value Range	-24–6
Default Value	0

BUSY_TONE_RPT

Value Format	Integer
Description	Specifies whether the busy tone is repeated.
Value Range	0–1 – 0: No Repeat – 1: Repeat
Default Value	1

BUSY_TONE_TIMING

Value Format	Comma-separated Integer
Description	Specifies the pattern, in milliseconds, of busy tones using up to 10 whole numbers (off 1, on 1, off 2, on 2...) separated by commas. Note <ul style="list-style-type: none"> It is recommended that you set a value of 60 milliseconds or more for the first value (off 1). Avoid setting 1–50 for any of the values.
Value Range	0–16000 (0: Infinite time)
Default Value	60,500,440

REORDER_TONE_FRQ

Value Format	Comma-separated Integer
Description	Specifies the dual-tone frequencies, in hertz, of reorder tones using 2 whole numbers separated by a comma.
Value Range	0, 200–2000 (0: No tone)
Default Value	480,620

REORDER_TONE_GAIN

Value Format	Integer
---------------------	---------

4.4.2 Tone Settings

Description	Specifies the gain, in decibels, of the reorder tone.
Value Range	-24–6
Default Value	0

REORDER_TONE_RPT

Value Format	Integer
Description	Specifies whether the reorder tone is repeated.
Value Range	0–1 – 0: No Repeat – 1: Repeat
Default Value	1

REORDER_TONE_TIMING

Value Format	Comma-separated Integer
Description	Specifies the pattern, in milliseconds, of reorder tones using up to 10 whole numbers (off 1, on 1, off 2, on 2...) separated by commas. Note <ul style="list-style-type: none">• It is recommended that you set a value of 60 milliseconds or more for the first value (off 1).• Avoid setting 1–50 for any of the values.
Value Range	0–16000 (0: Infinite time)
Default Value	60,250,190

RINGBACK_TONE_FRQ

Value Format	Comma-separated Integer
Description	Specifies the dual-tone frequencies, in hertz, of ringback tones using 2 whole numbers separated by a comma.
Value Range	0, 200–2000 (0: No tone)
Default Value	440,480

RINGBACK_TONE_GAIN

Value Format	Integer
Description	Specifies the gain, in decibels, of the ringback tone.
Value Range	-24–6

Default Value	0
---------------	---

RINGBACK_TONE_RPT

Value Format	Integer
Description	Specifies whether the ringback tone is repeated.
Value Range	0–1 – 0: No Repeat – 1: Repeat
Default Value	1

RINGBACK_TONE_TIMING

Value Format	Comma-separated Integer
Description	Specifies the pattern, in milliseconds, of ringback tones using up to 10 whole numbers (off 1, on 1, off 2, on 2...) separated by commas. Note <ul style="list-style-type: none"> • It is recommended that you set a value of 60 milliseconds or more for the first value (off 1). • Avoid setting 1–50 for any of the values.
Value Range	0–16000 (0: Infinite time)
Default Value	60,2000,3940

HOLD_TONE_FRQ

Value Format	Comma-separated Integer
Description	Specifies the dual-tone frequencies, in hertz, of the hold tone using 2 whole numbers separated by a comma.
Value Range	0, 200–2000 (0: No tone)
Default Value	425

HOLD_TONE_GAIN

Value Format	Integer
Description	Specifies the gain, in decibels, of the hold tone.
Value Range	-24–6
Default Value	0

BELL_CORE_PATTERN1_TIMING

Value Format	Comma-separated Integer
Description	<p>Specifies the cadence, in milliseconds, of pattern ID 1, described in the LSSGR, GR-506-CORE, "Signaling for Analog Interfaces" section 14, using up to 8 whole numbers (on 1, off 1, on 2, off 2...) separated by commas.</p> <p>Note</p> <ul style="list-style-type: none"> Avoid setting 1–99 for any of the values.
Value Range	0–5000 (0: Infinite time)
Default Value	2000,4000

BELL_CORE_PATTERN2_TIMING

Value Format	Comma-separated Integer
Description	<p>Specifies the cadence, in milliseconds, of pattern ID 2, described in the LSSGR, GR-506-CORE, "Signaling for Analog Interfaces" section 14, using up to 8 whole numbers (on 1, off 1, on 2, off 2...) separated by commas.</p> <p>Note</p> <ul style="list-style-type: none"> Avoid setting 1–99 for any of the values.
Value Range	0–5000 (0: Infinite time)
Default Value	800,400,800,4000

BELL_CORE_PATTERN3_TIMING

Value Format	Comma-separated Integer
Description	<p>Specifies the cadence, in milliseconds, of pattern ID 3, described in the LSSGR, GR-506-CORE, "Signaling for Analog Interfaces" section 14, using up to 8 whole numbers (on 1, off 1, on 2, off 2...) separated by commas.</p> <p>Note</p> <ul style="list-style-type: none"> Avoid setting 1–99 for any of the values.
Value Range	0–5000 (0: Infinite time)
Default Value	400,200,400,200,800,4000

BELL_CORE_PATTERN4_TIMING

Value Format	Comma-separated Integer
---------------------	-------------------------

Description	Specifies the cadence, in milliseconds, of pattern ID 4, described in the LSSGR, GR-506-CORE, "Signaling for Analog Interfaces" section 14, using up to 8 whole numbers (on 1, off 1, on 2, off 2...) separated by commas. Note <ul style="list-style-type: none">Avoid setting 1–99 for any of the values.
Value Range	0–5000 (0: Infinite time)
Default Value	300,200,1000,200,300,4000

BELL_CORE_PATTERN5_TIMING

Value Format	Comma-separated Integer
Description	Specifies the cadence, in milliseconds, of pattern ID 5, described in the LSSGR, GR-506-CORE, "Signaling for Analog Interfaces" section 14, using up to 8 whole numbers (on 1, off 1, on 2, off 2...) separated by commas. Note <ul style="list-style-type: none">Avoid setting 1–99 for any of the values.
Value Range	0–5000 (0: Infinite time)
Default Value	500

4.4.3 Telephone Settings

NUMBER_MATCHING_LOWER_DIGIT

Value Format	Integer
Description	Specifies the minimum number of digits with which to match a phonebook entry with an incoming call's caller ID. To specify exact matching of entire numbers only, specify "0".
Value Range	0–15
Default Value	7

NUMBER_MATCHING_UPPER_DIGIT

Value Format	Integer
Description	Specifies the maximum number of digits with which to match a phonebook entry with an incoming call's caller ID. To specify exact matching of entire numbers only, specify "0".
Value Range	0–15
Default Value	10

DEFAULT_LANGUAGE

Value Format	String
Description	Selects the language to use for the menus and display items on the phone.
Value Range	<p>Only the following values are available:</p> <ul style="list-style-type: none"> • en-GB (English (UK)) • de (German) • fr (French) • it (Italian) • es (Spanish) • nl (Dutch) • sv (Swedish) • da (Danish) • pt (Portuguese) • ru (Russian) • el (Greek) • pl (Polish) • cs (Czech) • sk (Slovak) • hu (Hungarian) • hr (Croatian) • uk (Ukrainian) • en-US (English (US)) • fr-CA (French (Canadian)) • es-LA (Latin Spanish) • pt-BR (Brazilian Portuguese)
Default Value	en-US

POUND_KEY_DELIMITER_ENABLE

Value Format	Boolean
Description	Specifies whether the # key is treated as a regular dialed digit or a delimiter, when dialed as or after the second digit.
Value Range	<ul style="list-style-type: none"> • y (# is treated as the end of dialing delimiter) • n (# is treated as a regular dialed digit)
Default Value	y

FLEXIBLE_KEY_LIST_DISPLAY_TIMER

Value Format	Integer
Description	Specifies, in seconds, the length of time that the PBX Flexible Button List is displayed on the phone.

Value Range	0–255
Default Value	15

4.4.4 SIP-CS Settings

WL_PSREGISTRATION_PIN

Value Format	String
Description	Specifies the PIN (Personal Identification Number) used when registering the S-PS.
Value Range	4 digits (consisting of 0–9)
Default Value	1234

WL_AIRSYNCGROUP_CS

Value Format	Integer
Description	Specifies the Air Sync Group of the SIP-CS. Notice <ul style="list-style-type: none"> All calls will be disconnected when you change this setting.
Value Range	1–8
Default Value	1

SUPERMASTER_IPADDRESS_CS

Value Format	String
Description	Specifies the IP address of the Super Master CS to which the SIP-CS is connected. Notice <ul style="list-style-type: none"> All calls will be disconnected when you change this setting.
Value Range	IP address in dotted-decimal notation
Default Value	Empty string

WL_CLASS_CS

Value Format	String
Description	Specifies the classification of the SIP-CS. Notice <ul style="list-style-type: none"> All calls will be disconnected when you change this setting.

4.4.4 SIP-CS Settings

Value Range	<ul style="list-style-type: none">• Slave• Master• SecondMaster
Default Value	Slave

HO_RTP_PORT_MIN

Value Format	Integer
Description	Specifies the lowest port number used for RTP packets when performing a call handover.
Value Range	1024–47152 Note <ul style="list-style-type: none">• The value for this setting must be less than or equal to "HO_RTP_PORT_MAX" - 1999.
Default Value	40000

HO_RTP_PORT_MAX

Value Format	Integer
Description	Specifies the highest port number used for RTP packets when performing a call handover.
Value Range	3023–49151 Note <ul style="list-style-type: none">• The value for this setting must be greater than or equal to "HO_RTP_PORT_MIN" + 1999.
Default Value	42000

HO_EXE_TIME

Value Format	Integer
Description	Specifies the processing speed as opposed to sound quality when performing a call handover.
Value Range	<ul style="list-style-type: none">• 4 (Processing speed is very fast)• 3 (Processing speed is fast)• 2 (Processing speed is medium)• 1 (Processing speed is slow)• 0 (Processing speed is very slow)
Default Value	2

4.4.5 Flexible Button Settings

FLEX_BUTTON_FACILITY_ACTx_PSy

Value Format	String
Description	Specifies a particular Facility Action for the flexible button. No facility action will be taken for the button if the string is empty or invalid. Note <ul style="list-style-type: none"> If this parameter is specified, "FLEX_BUTTON_QUICK_DIALx_PSy" should be an empty string.
Value Range	<ul style="list-style-type: none"> X_PANASONIC_IPTEL_DN X_PANASONIC_IPTEL_ONETOUCH
Default Value	X_PANASONIC_IPTEL_DN

FLEX_BUTTON_FACILITY_ARGx_PSy

Value Format	String
Description	Optional argument associated with the specified Facility Action for the flexible button. For details, see 6.3.1 Flexible Button Settings .
Value Range	Max. 32 characters
Default Value	1

FLEX_BUTTON_QUICK_DIALx_PSy

Value Format	String
Description	Specifies a quick dial destination number to be used for the flexible button. Note <ul style="list-style-type: none"> If this parameter is specified, "FLEX_BUTTON_FACILITY_ACTx_PSy" should be an empty string. This parameter cannot be specified via Web user interface programming. Therefore, when using Web user programming and configuration file programming in conjunction, "FLEX_BUTTON_FACILITY_ACTx_PSy" should be set to "X_PANASONIC_IPTEL_ONETOUCH".
Value Range	Max. 32 characters (consisting of 0–9, *, and #)
Default Value	Empty string

4.5.1 Codec Settings

FLEX_BUTTON_LABELx_PSy

Value Format	String
Description	Specifies the message to be displayed on the screen when the flexible button is pressed.
Value Range	Max. 10 characters Note <ul style="list-style-type: none">You can use Unicode characters for this setting.
Default Value	Empty string

4.5 VoIP Settings

4.5.1 Codec Settings

CODEC_G711_REQ

Value Format	Integer
Description	Specifies whether to set "PCMU" as a codec selection automatically when the codec is set to any codec selection other than "PCMU".
Value Range	<ul style="list-style-type: none">0 (Do not set "PCMU")1 (Set "PCMU")
Default Value	1

CODEC_G729_PARAM

Value Format	Integer
Description	Specifies whether to add an attribute line, "a=fmtp:18 annexb=no", to SDP when the codec is set to "G729A".
Value Range	<ul style="list-style-type: none">0 (Do not add "a=fmtp:18 annexb=no")1 (Add "a=fmtp:18 annexb=no")
Default Value	0

CODEC_ENABLEx

Value Format	Boolean
---------------------	---------

Description	Specifies whether to enable the codec specified in the parameter list. Note <ul style="list-style-type: none"> • The "x" character in the parameter title should be changed to one of the following numbers, according to the codec to be changed. <ul style="list-style-type: none"> – 0: G.722 – 1: PCMA – 2: G.726-32 – 3: G.729A – 4: PCMU • For codec setting examples, see 3.5.1 Examples of Codec Settings.
Value Range	<ul style="list-style-type: none"> • Y (Enable) • N (Disable)
Default Value	Y

CODEC_PRIORITYx

Value Format	Integer
Description	Specifies the priority order for the codec. Note <ul style="list-style-type: none"> • The "x" character in the parameter title should be changed to one of the following numbers, according to the codec to be changed. <ul style="list-style-type: none"> – 0: G.722 – 1: PCMA – 2: G.726-32 – 3: G.729A – 4: PCMU • For codec setting examples, see 3.5.1 Examples of Codec Settings.
Value Range	1–255
Default Value	1

4.5.2 RTP Settings

DSCP_RTP

Value Format	Integer
Description	Selects the DSCP level of DiffServ applied to RTP packets.
Value Range	0–63
Default Value	0

DSCP_RTCP

Value Format	Integer
Description	Selects the DSCP level of DiffServ applied to RTCP packets.
Value Range	0–63
Default Value	0

RTCP_INTVL

Value Format	Integer
Description	Specifies the interval, in seconds, between RTCP packets.
Value Range	5–65535
Default Value	5

MAX_DELAY

Value Format	Integer
Description	Specifies the maximum delay, in 10-millisecond units, of the jitter buffer.
Value Range	3–50 (× 10 ms) Note <ul style="list-style-type: none"> • This setting is subject to the following conditions: <ul style="list-style-type: none"> – This value must be greater than "NOM_DELAY" – This value must be greater than "MIN_DELAY" – "NOM_DELAY" must be greater than or equal to "MIN_DELAY"
Default Value	20

MIN_DELAY

Value Format	Integer
Description	Specifies the minimum delay, in 10-millisecond units, of the jitter buffer.
Value Range	1 or 2 (× 10 ms) Note <ul style="list-style-type: none"> • This setting is subject to the following conditions: <ul style="list-style-type: none"> – This value must be less than or equal to "NOM_DELAY" – This value must be less than "MAX_DELAY" – "MAX_DELAY" must be greater than "NOM_DELAY"
Default Value	2

NOM_DELAY

Value Format	Integer
Description	Specifies the initial delay, in 10-millisecond units, of the jitter buffer.
Value Range	1–7 (× 10 ms) Note <ul style="list-style-type: none"> This setting is subject to the following conditions: <ul style="list-style-type: none"> – This value must be greater than or equal to "MIN_DELAY" – This value must be less than "MAX_DELAY"
Default Value	2

RTP_PORT_MIN

Value Format	Integer
Description	Specifies the lowest port number that the SIP-CS will use for RTP packets.
Value Range	1024–45150 (even number only) Note <ul style="list-style-type: none"> The value for this setting must be less than or equal to "RTP_PORT_MAX" - 4000. Changing this setting may affect the number of simultaneous calls that can be made. Therefore, when setting this parameter, be aware that the maximum number of necessary ports can be calculated as shown below: No. of lines × No. of channels × 2 × 1 (No. of terminals)
Default Value	16000

RTP_PORT_MAX

Value Format	Integer
Description	Specifies the highest port number that the SIP-CS will use for RTP packets.
Value Range	5024–49150 (even number only) Note <ul style="list-style-type: none"> The value for this setting must be greater than or equal to "RTP_PORT_MIN" + 4000. Changing this setting may affect the number of simultaneous calls that can be made. Therefore, when setting this parameter, be aware that the maximum number of necessary ports can be calculated as shown below: No. of lines × No. of channels × 2 × 1 (No. of terminals)
Default Value	29000

RTP_PTIME

Value Format	Integer
Description	Specifies the interval, in milliseconds, between transmissions of RTP packets.
Value Range	<ul style="list-style-type: none"> • 20 • 30 • 40
Default Value	20

RTCP_ENABLE

Value Format	Boolean
Description	Selects whether to enable or disable RTCP (Real-Time Transport Control Protocol). For details, refer to RFC 3550.
Value Range	<ul style="list-style-type: none"> • Y (Enable RTCP) • N (Disable RTCP)
Default Value	N

RTCP_SEND_BY_SDP

Value Format	Integer
Description	Specifies whether to send RTCP signals by SDP (Session Description Protocol).
Value Range	0–1 – 0: Send RTCP signals using the value specified in "RTCP_INTVL", if the "RTCP_ENABLE" parameter is enabled. – 1: Send RTCP signals using the value specified in the SDP attribute "a=rtcp:".
Default Value	0

RTP_CLOSE_ENABLE

Value Format	Boolean
Description	Specifies whether to enable processing to close held RTP sockets.
Value Range	<ul style="list-style-type: none"> • Y (Enable RTP Close) • N (Disable RTP Close)
Default Value	Y

4.5.3 Miscellaneous VoIP Settings

OUTBANDDTMF

Value Format	Boolean
Description	Specifies the method for transmitting DTMF tones.
Value Range	<ul style="list-style-type: none"> • Y (Outband [use telephone-event]) • N (Inband) <p>Note</p> <ul style="list-style-type: none"> • If set to "Y", DTMF tones will be sent through SDP, compliant with RFC 2833. • If set to "N", DTMF tones will be encoded in the RTP stream.
Default Value	Y

DTMF_RELAY

Value Format	Boolean
Description	Selects whether DTMF tones are sent in the SIP INFO message.
Value Range	<ul style="list-style-type: none"> • Y • N <p>Note</p> <ul style="list-style-type: none"> • If set to "Y", DTMF tones will be sent in the SIP INFO message. • If set to "N", the method selected in "OUTBANDDTMF" will be used.
Default Value	N

OUTBANDDTMF_VOL

Value Format	Integer
Description	Specifies the volume (in decibels [dB]) of the DTMF tone using RFC 2833.
Value Range	-63–0
Default Value	-5

INBANDDTMF_VOL

Value Format	Integer
Description	Specifies the volume (in decibels [dB]) of in-band DTMF tones.
Value Range	-46–0

4.5.3 Miscellaneous VoIP Settings

Default Value	-5
---------------	----

TELEVENT_PAYLOAD

Value Format	Integer
Description	Specifies the RFC 2833 payload type for DTMF tones. Note <ul style="list-style-type: none">This setting is available only when "OUTBANDDTMF" is set to "Y".
Value Range	96–127
Default Value	101

RFC2543_HOLD_ENABLE

Value Format	Boolean
Description	Specifies whether to enable the RFC 2543 Call Hold feature on this line.
Value Range	<ul style="list-style-type: none">Y (Enable RFC 2543 Call Hold)N (Disable RFC 2543 Call Hold) Note <ul style="list-style-type: none">If set to "Y", the "c=0.0.0.0" syntax will be set in SDP when sending a re-INVITE message to hold the call.If set to "N", the "c=x.x.x.x" syntax will be set in SDP.
Default Value	Y

DTMF_SIGNAL_LEN

Value Format	Integer
Description	Specifies the length of the DTMF signal, in milliseconds.
Value Range	60–200
Default Value	180

DTMF_INTDIGIT_TIM

Value Format	Integer
Description	Specifies the interval, in milliseconds, between DTMF signals.
Value Range	60–200
Default Value	90

4.6 Line Settings

4.6.1 Call Control Settings

DISPLAY_NAME_PSy_n

Parameter Name Example	DISPLAY_NAME_PS1_1, DISPLAY_NAME_PS1_2, DISPLAY_NAME_PS2_1, DISPLAY_NAME_PS2_2, : DISPLAY_NAME_PS255_1, DISPLAY_NAME_PS255_2
Value Format	String
Description	Specifies the name to display as the caller on the other party's phone when you make a call.
Value Range	Max. 24 characters Note • You can use Unicode characters for this setting.
Default Value	Empty string

VM_NUMBER_PSy_n

Parameter Name Example	VM_NUMBER_PS1_1, VM_NUMBER_PS1_2, VM_NUMBER_PS2_1, VM_NUMBER_PS2_2, : VM_NUMBER_PS255_1, VM_NUMBER_PS255_2
Value Format	String
Description	Specifies the phone number used to access the voice mail server. Note • Your phone system must support voice mail.
Value Range	Max. 32 characters
Default Value	Empty string

DIAL_PLAN_PSy

Value Format	String
Description	Specifies a dial format, such as specific phone numbers, that control which numbers can be dialed or how to handle the call when making a call. For details, see 6.2 Dial Plan .
Value Range	Max. 500 characters
Default Value	Empty string

DIAL_PLAN_NOT_MATCH_ENABLE_PSy

Value Format	Boolean
Description	Specifies whether to enable dial plan filtering so that a call is not made when the dialed number does not match any of the dial formats specified in "DIAL_PLAN_PSy".
Value Range	<ul style="list-style-type: none"> Y (Enable dial plan filtering) N (Disable dial plan filtering) <p>Note</p> <ul style="list-style-type: none"> If set to "Y", the dialed number will not be sent to the line when the number dialed by the user does not match any of the dial formats specified in the dial plan. If set to "N", the dialed number will be sent to the line, even if the number dialed by the user does not match any of the dial formats specified in the dial plan.
Default Value	N

SHARED_CALL_ENABLE_PSy_n

Parameter Name Example	SHARED_CALL_ENABLE_PS1_1, SHARED_CALL_ENABLE_PS1_2, SHARED_CALL_ENABLE_PS2_1, SHARED_CALL_ENABLE_PS2_2, : SHARED_CALL_ENABLE_PS255_1, SHARED_CALL_ENABLE_PS255_2
Value Format	Boolean
Description	Specifies whether to enable the Shared Call feature of the SIP server, which is used to share one line among the SIP-CSs. Note <ul style="list-style-type: none"> You cannot set both "SHARED_CALL_ENABLE_PSy_n" and "FWD_DND_SYNCHRO_ENABLE_PSy_n" to "Y" at the same time. Availability depends on your phone system.
Value Range	<ul style="list-style-type: none"> Y (Enable shared call) N (Disable shared call) <p>Note</p> <ul style="list-style-type: none"> If set to "Y", the SIP server will control the line by using a shared-call signaling method. If set to "N", the SIP server will control the line by using a standard signaling method.
Default Value	N

FWD_DND_SYNCHRO_ENABLE_PSy_n

Parameter Name Example	FWD_DND_SYNCHRO_ENABLE_PS1_1, FWD_DND_SYNCHRO_ENABLE_PS1_2, FWD_DND_SYNCHRO_ENABLE_PS2_1, FWD_DND_SYNCHRO_ENABLE_PS2_2, : FWD_DND_SYNCHRO_ENABLE_PS255_1, FWD_DND_SYNCHRO_ENABLE_PS255_2
Value Format	Boolean
Description	Specifies whether to synchronize the Do Not Disturb and Call Forward settings, configured via the Web user interface, between the SIP-CS and the portal server that is provided by your dealer. Note <ul style="list-style-type: none"> • Even if you specify "Y", this feature may not function properly if your phone system does not support it. Before you configure this setting, consult your dealer. • You cannot set both "SHARED_CALL_ENABLE_PSy_n" and "FWD_DND_SYNCHRO_ENABLE_PSy_n" to "Y" at the same time.
Value Range	<ul style="list-style-type: none"> • Y (Enable Do Not Disturb/Call Forward synchronization) • N (Disable Do Not Disturb/Call Forward synchronization)
Default Value	N

CW_ENABLE_PSy_n

Parameter Name Example	CW_ENABLE_PS1_1, CW_ENABLE_PS1_2, CW_ENABLE_PS2_1, CW_ENABLE_PS2_2, : CW_ENABLE_PS255_1, CW_ENABLE_PS255_2
Value Format	Boolean
Description	Specifies whether automatic call waiting is enabled.
Value Range	<ul style="list-style-type: none"> • Y (Enable Call Waiting) • N (Disable Call Waiting)
Default Value	Y

RETURN_VOL_SET_DEFAULT_ENABLE

Value Format	Boolean
Description	Specifies whether the volume is returned to its default setting after each call.
Value Range	<ul style="list-style-type: none"> • Y (Volume returns to the default setting after each call) • N (Volume does not change after each call)

4.6.1 Call Control Settings

Default Value	N
---------------	----------

FLASH_RECALL_TERMINATE

Value Format	Boolean
Description	Selects the function of the FLASH/RECALL button during a conversation.
Value Range	<ul style="list-style-type: none">• Y (Terminate)• N (EFA)
Default Value	Y

FLASHHOOK_CONTENT_TYPE

Value Format	String
Description	Specifies the type of signal sent when sending a flash hook event.
Value Range	<ul style="list-style-type: none">• Signal• flashhook
Default Value	Signal

VOICE_MESSAGE_AVAILABLE

Value Format	Boolean
Description	Selects how the existence of voice messages is determined when a "Messages-Waiting: yes" message is received.
Value Range	<ul style="list-style-type: none">• Y (Determines that voice messages exist when "Messages-Waiting: yes" is received with a "Voice-Message" line included.)• N (Determines that voice messages exist when "Messages-Waiting: yes" is received even without a "Voice-Message" line included.)
Default Value	Y

HOLD_SOUND_PATH

Value Format	Integer
--------------	---------

Description	Selects whether the SIP-CS's hold tone or the network server's hold tone (Music on hold) is played when a party is put on hold. Note <ul style="list-style-type: none"> It is necessary to set the following parameters to play the SIP-CS's hold tone. <ul style="list-style-type: none"> <code>HOLD_TONE_FRQ</code> <code>HOLD_TONE_GAIN</code>
Value Range	0–1 <ul style="list-style-type: none"> 0: The SIP-CS's hold tone is played. 1: The network server's hold tone (Music on hold) is played.
Default Value	0

4.6.2 SIP Settings

SIP_USER_AGENT

Value Format	String
Description	Specifies the text string to send as the user agent in the headers of SIP messages.
Value Range	Max. 40 characters Note <ul style="list-style-type: none"> An empty string is not allowed. If "{mac}" is included in this parameter, it will be replaced with the SIP-CS's MAC address in lower-case. If "{MAC}" is included in this parameter, it will be replaced with the SIP-CS's MAC address in upper-case. If "{MODEL}" is included in this parameter, it will be replaced with the SIP-CS's model name. If "{fwver}" is included in this parameter, it will be replaced with the firmware version of the SIP-CS.
Default Value	Panasonic_{MODEL}/{fwver} ({mac})

PHONE_NUMBER_PSy_n

Parameter Name Example	PHONE_NUMBER_PS1_1, PHONE_NUMBER_PS1_2, PHONE_NUMBER_PS2_1, PHONE_NUMBER_PS2_2, : PHONE_NUMBER_PS255_1, PHONE_NUMBER_PS255_2
Value Format	String

4.6.2 SIP Settings

Description	Specifies the phone number to use as the user ID required for registration to the SIP registrar server. Note <ul style="list-style-type: none">When registering using a user ID that is not a phone number, you should use the "SIP_URI" setting.
Value Range	Max. 32 characters
Default Value	Empty string

SIP_URI_PSy_n

Parameter Name Example	SIP_URI_PS1_1, SIP_URI_PS1_2, SIP_URI_PS2_1, SIP_URI_PS2_2, : SIP_URI_PS255_1, SIP_URI_PS255_2
Value Format	String
Description	Specifies the unique ID used by the SIP registrar server, which consists of "sip:", a user part, the "@" symbol, and a host part, for example, "sip:user@example.com". Note <ul style="list-style-type: none">When registering using a user ID that is not a phone number, you should use this setting.In a SIP URI, the user part ("user" in the example above) can contain up to 63 characters, and the host part ("example.com" in the example above) can contain up to 127 characters.
Value Range	Max. 195 characters (except ", &, ', :, ;, <, >, and space)
Default Value	Empty string

LINE_ENABLE_PSy_n

Parameter Name Example	LINE_ENABLE_PS1_1, LINE_ENABLE_PS1_2, LINE_ENABLE_PS2_1, LINE_ENABLE_PS2_2, : LINE_ENABLE_PS255_1, LINE_ENABLE_PS255_2
Value Format	String
Description	Specifies whether a line is enabled or disabled. Note <ul style="list-style-type: none">Even when this parameter is enabled, if the "PROFILE_ENABLE_PSy" parameter is disabled, the line will be disabled.
Value Range	<ul style="list-style-type: none">DisabledEnabled

Default Value	Enabled
---------------	---------

PROFILE_ENABLE_PSy

Value Format	String
Description	Specifies whether all lines in the profile are enabled or disabled. Note <ul style="list-style-type: none"> Even when this parameter is enabled, if the "LINE_ENABLE_PSy_n" parameter is disabled, the line will be disabled.
Value Range	<ul style="list-style-type: none"> Disabled Enabled
Default Value	Enabled

PROFILE_NAME_CS PROFILE_NAME_PSy

Value Format	String
Description	Specifies the name of the SIP-CS or S-PS.
Value Range	Max. 20 characters
Default Value	Empty string

SIP_AUTHID_PSy_n

Parameter Name Example	SIP_AUTHID_PS1_1, SIP_AUTHID_PS1_2, SIP_AUTHID_PS2_1, SIP_AUTHID_PS2_2, : SIP_AUTHID_PS255_1, SIP_AUTHID_PS255_2
Value Format	String
Description	Specifies the authentication ID required to access the SIP server.
Value Range	Max. 127 characters (except ", &, ', :, <, >, and space)
Default Value	Empty string

SIP_PASS_PSy_n

Parameter Name Example	SIP_PASS_PS1_1, SIP_PASS_PS1_2, SIP_PASS_PS2_1, SIP_PASS_PS2_2, : SIP_PASS_PS255_1, SIP_PASS_PS255_2
------------------------	---

4.6.2 SIP Settings

Value Format	String
Description	Specifies the authentication password used to access the SIP server.
Value Range	Max. 127 characters (except ", &, ', :, <, >, and space)
Default Value	Empty string

SIP_SRC_PORT_PSy_n

Parameter Name Example	SIP_SRC_PORT_PS1_1, SIP_SRC_PORT_PS1_2, SIP_SRC_PORT_PS2_1, SIP_SRC_PORT_PS2_2, : SIP_SRC_PORT_PS255_1, SIP_SRC_PORT_PS255_2
Value Format	Integer
Description	Specifies the source port number used by the SIP-CS for SIP communication.
Value Range	1024–49151 Note <ul style="list-style-type: none">The SIP port number for each line must be unique.
Default Value	<ul style="list-style-type: none">PS1 Line1: 5061PS1 Line2: 5062PS2 Line1: 5063... Note <ul style="list-style-type: none">The default value increases by 1 for each line.

SIP_PRXY_ADDR

Value Format	String
Description	Specifies the IP address or FQDN of the SIP proxy server.
Value Range	Max. 127 characters (IP address in dotted-decimal notation or FQDN)
Default Value	Empty string

SIP_PRXY_PORT

Value Format	Integer
Description	Specifies the port number to use for communication with the SIP proxy server.
Value Range	1–65535
Default Value	5060

SIP_RGSTR_ADDR

Value Format	String
Description	Specifies the IP address or FQDN of the SIP registrar server.
Value Range	Max. 127 characters (IP address in dotted-decimal notation or FQDN)
Default Value	Empty string

SIP_RGSTR_PORT

Value Format	Integer
Description	Specifies the port number to use for communication with the SIP registrar server.
Value Range	1–65535
Default Value	5060

SIP_SVCDOMAIN

Value Format	String
Description	Specifies the domain name provided by your dealer. The domain name is the part of the SIP URI that comes after the "@" symbol.
Value Range	Max. 127 characters
Default Value	Empty string

REG_EXPIRE_TIME

Value Format	Integer
Description	Specifies the length of time, in seconds, that the registration remains valid. This value is set in the "Expires" header of the REGISTER request.
Value Range	1–4294967295
Default Value	3600

REG_INTERVAL_RATE

Value Format	Integer
Description	Specifies the percentage of the "expires" value after which to refresh registration by sending a new REGISTER message in the same dialog.
Value Range	1–100
Default Value	90

SIP_SESSION_TIME

Value Format	Integer
Description	Specifies the length of time, in seconds, that the SIP-CS waits before terminating SIP sessions when no reply to repeated requests is received. For details, refer to RFC 4028.
Value Range	0, 60–65535 (0: Disable)
Default Value	0

SIP_SESSION_METHOD

Value Format	Integer
Description	Selects the refreshing method of SIP sessions.
Value Range	0–2 – 0: reINVITE – 1: UPDATE – 2: AUTO
Default Value	0

DSCP_SIP

Value Format	Integer
Description	Selects the DSCP level of DiffServ applied to SIP packets.
Value Range	0–63
Default Value	0

SIP_2NDPROXY_ADDR

Value Format	String
Description	Specifies the IP address of the secondary SIP proxy server. Note • This setting is available only when "SIP_PROXY_ADDR" is specified in IP address notation.
Value Range	Max. 127 characters (IP address in dotted-decimal notation or FQDN)
Default Value	Empty string

SIP_2NDPROXY_PORT

Value Format	Integer
---------------------	---------

Description	Specifies the port number to use for communication with the secondary SIP proxy server.
Value Range	1–65535
Default Value	5060

SIP_2NDRGSTR_ADDR

Value Format	String
Description	Specifies the IP address of the secondary SIP registrar server. Note <ul style="list-style-type: none"> This setting is available only when "SIP_RGSTR_ADDR" is specified in IP address notation.
Value Range	Max. 127 characters (IP address in dotted-decimal notation or FQDN)
Default Value	Empty string

SIP_2NDRGSTR_PORT

Value Format	Integer
Description	Specifies the port number to use for communication with the secondary SIP registrar server.
Value Range	1–65535
Default Value	5060

SIP_TIMER_T1

Value Format	Integer
Description	Specifies the default interval, in milliseconds, between transmissions of SIP messages. For details, refer to RFC 3261.
Value Range	<ul style="list-style-type: none"> 250 500 1000 2000 4000
Default Value	500

SIP_TIMER_T2

Value Format	Integer
Description	Specifies the maximum interval, in seconds, between transmissions of SIP messages. For details, refer to RFC 3261.

4.6.2 SIP Settings

Value Range	<ul style="list-style-type: none">• 2• 4• 8• 16• 32
Default Value	4

SIP_TIMER_T4

Value Format	Integer
Description	Specifies the maximum period, in seconds, that a message can remain on the network.
Value Range	<ul style="list-style-type: none">• 0• 1• 2• 3• 4• 5
Default Value	0

SIP_FOVR_NORSP

Value Format	Boolean
Description	Specifies whether to perform the fail-over process when the SIP-CS detects that the SIP server is not replying to SIP message.
Value Range	<ul style="list-style-type: none">• Y (Enable fail-over)• N (Disable fail-over) <p>Note</p> <ul style="list-style-type: none">• If set to "Y", the SIP-CS will try to use the other SIP servers via the DNS SRV and A records.• If set to "N", the SIP-CS will not try to use the other SIP servers.
Default Value	Y

SIP_FOVR_MAX

Value Format	Integer
Description	Specifies the maximum number of servers (including the first [normal] server) used in the fail-over process.
Value Range	1–4
Default Value	2

SIP_REFRESHER

Value Format	Integer
Description	Specifies whether to add the refresher parameter for Session Expire in SIP INVITE.
Value Range	0–2 <ul style="list-style-type: none"> – 0: Do not add the refresher parameter – 1: Add the refresher parameter with the value "UAS" – 2: Add the refresher parameter with the value "UAC"
Default Value	0

SIP_DNSSRV_ENA

Value Format	Boolean
Description	Specifies whether to request the DNS server to translate domain names into IP addresses using the SRV record.
Value Range	<ul style="list-style-type: none"> • Y (Enable DNS SRV lookup) • N (Disable DNS SRV lookup) <p>Note</p> <ul style="list-style-type: none"> • If set to "Y", the SIP-CS will perform a DNS SRV lookup for a SIP registrar server, SIP proxy server, SIP outbound proxy server, or SIP presence server. • If set to "N", the SIP-CS will not perform a DNS SRV lookup for a SIP registrar server, SIP proxy server, SIP outbound proxy server, or SIP presence server.
Default Value	Y

SIP_UDP_SRV_PREFIX

Value Format	String
Description	Specifies a prefix to add to the domain name when performing a DNS SRV lookup using UDP. Note <ul style="list-style-type: none"> • This setting is available only when "SIP_DNSSRV_ENA" is set to "Y".
Value Range	Max. 32 characters
Default Value	_sip._udp.

SIP_TCP_SRV_PREFIX

Value Format	String
---------------------	--------

4.6.2 SIP Settings

Description	Specifies a prefix to add to the domain name when performing a DNS SRV lookup using TCP. Note <ul style="list-style-type: none">This setting is available only when "SIP_DNSSRV_ENA" is set to "Y".
Value Range	Max. 32 characters
Default Value	_sip._tcp.

SIP_100REL_ENABLE

Value Format	Boolean
Description	Specifies whether to add the option tag 100rel to the "Supported" header of the INVITE message. For details, refer to RFC 3262.
Value Range	<ul style="list-style-type: none">Y (Enable 100rel function)N (Disable 100rel function) Note <ul style="list-style-type: none">If set to "Y", the Reliability of Provisional Responses function will be enabled. The option tag 100rel will be added to the "Supported" header of the INVITE message and to the "Require" header of the "1xx" provisional message.If set to "N", the option tag 100rel will not be used.
Default Value	N

SIP_INVITE_EXPIRE

Value Format	Integer
Description	Specifies the period, in seconds, in which the INVITE message will expire.
Value Range	0, 60–65535 (0: Disable)
Default Value	0

SIP_18X_RTX_INTVL

Value Format	Integer
Description	Specifies the retransmission interval, in seconds, for "18x" responses.
Value Range	0, 1–600 (0: Disable)
Default Value	0

SIP_PRSNC_ADDR

Value Format	String
Description	Specifies the IP address or FQDN of the SIP presence server.
Value Range	Max. 127 characters (IP address in dotted-decimal notation or FQDN)
Default Value	Empty string

SIP_PRSNC_PORT

Value Format	Integer
Description	Specifies the port number to use for communication with the SIP presence server.
Value Range	1–65535
Default Value	5060

SIP_2NDPRSNC_ADDR

Value Format	String
Description	Specifies the IP address of the secondary presence server. Note <ul style="list-style-type: none"> This setting is available only when "SIP_PRSNC_ADDR" is specified in IP address notation.
Value Range	Max. 127 characters (IP address in dotted-decimal notation or FQDN)
Default Value	Empty string

SIP_2NDPRSNC_PORT

Value Format	Integer
Description	Specifies the port number to use for communication with the secondary SIP presence server.
Value Range	1–65535
Default Value	5060

USE_DEL_REG_OPEN

Value Format	Boolean
Description	Specifies whether to enable cancelation before registration when, for example, the SIP-CS is turned on.

4.6.2 SIP Settings

Value Range	<ul style="list-style-type: none">• Y (Enable cancelation before registration)• N (Disable cancelation before registration)
Default Value	N

PORT_PUNCH_INTVL

Value Format	Integer
Description	Specifies the interval, in seconds, between transmissions of the Keep Alive packet to the SIP-CS in order to maintain the NAT binding information. Note <ul style="list-style-type: none">• This setting is available only when "SIP_TRANSPORT" is set to "0" for UDP.
Value Range	0, 10–300 (0: Disable)
Default Value	0

SIP_ADD_RPORT

Value Format	Boolean
Description	Selects whether to add the 'rport' parameter to the top Via header field value of requests generated. For details, refer to RFC 3581.
Value Range	<ul style="list-style-type: none">• Y (Add Rport [RFC 3581])• N (Do not add Rport [RFC 3581])
Default Value	N

SIP_REQURI_PORT

Value Format	Boolean
Description	Specifies whether to add the port parameter to the Request-Line in the initial SIP request.
Value Range	<ul style="list-style-type: none">• Y (Add the port parameter)• N (Do not add the port parameter) Note <ul style="list-style-type: none">• Request URI in REGISTER example:<ul style="list-style-type: none">– If set to "Y", the port parameter is added to the Request-Line, as follows: Request-Line: REGISTER sip:192.168.0.10:5060 SIP/2.0– If set to "N", the port parameter is not added to the Request-Line, as follows: Request-Line: REGISTER sip:192.168.0.10 SIP/2.0
Default Value	Y

SIP_SUBS_EXPIRE

Value Format	Integer
Description	Specifies the length of time, in seconds, that the subscription remains valid. This value is set in the "Expires" header of the SUBSCRIBE request.
Value Range	1–4294967295
Default Value	3600

SUB_RTX_INTVL

Value Format	Integer
Description	Specifies the interval, in seconds, between transmissions of SUBSCRIBE requests when a subscription results in failure (server no reply or error reply). Note <ul style="list-style-type: none"> • Transmissions will not be sent when the "403 Forbidden" error occurred.
Value Range	10–86400
Default Value	10

REG_RTX_INTVL

Value Format	Integer
Description	Specifies the interval, in seconds, between transmissions of the REGISTER request when a registration results in failure (server no reply or error reply). Note <ul style="list-style-type: none"> • Transmissions will not be sent when the "403 Forbidden" error occurred.
Value Range	10–86400
Default Value	10

SIP_P_PREFERRED_ID

Value Format	Boolean
Description	Specifies whether to add the "P-Preferred-Identity" header to SIP messages.
Value Range	<ul style="list-style-type: none"> • y (Add the "P-Preferred-Identity" header) • n (Do not add the "P-Preferred-Identity" header)

4.6.2 SIP Settings

Default Value	N
---------------	---

SIP_PRIVACY

Value Format	Boolean
Description	Specifies whether to add the "Privacy" header to SIP messages.
Value Range	<ul style="list-style-type: none">Y (Add the "Privacy" header)N (Do not add the "Privacy" header)
Default Value	N

ADD_USER_PHONE

Value Format	Boolean
Description	Specifies whether to add "user=phone" to the SIP URI in SIP messages.
Value Range	<ul style="list-style-type: none">Y (Add "user=phone")N (Do not add "user=phone") <p>Note</p> <ul style="list-style-type: none">SIP URI example:<ul style="list-style-type: none">"sip:1111@tokyo.example.com;user=phone", when set to "Y""sip:1111@tokyo.example.com", when set to "N"
Default Value	N

SDP_USER_ID

Value Format	String
Description	Specifies the user ID used in the "o=" line field of SDP.
Value Range	Max. 32 characters (except ", &, ', :, <, >, and space)
Default Value	-

SUB_INTERVAL_RATE

Value Format	Integer
Description	Specifies the percentage of the "expires" value after which to refresh subscriptions by sending a new SUBSCRIBE message in the same dialog.
Value Range	1–100
Default Value	90

SIP_OUTPROXY_ADDR

Value Format	String
Description	Specifies the IP address or FQDN of the SIP outbound proxy server.
Value Range	Max. 127 characters (IP address in dotted-decimal notation or FQDN)
Default Value	Empty string

SIP_OUTPROXY_PORT

Value Format	Integer
Description	Specifies the port number to use for communication with the SIP outbound proxy server.
Value Range	1–65535
Default Value	5060

SIP_TRANSPORT

Value Format	Integer
Description	Specifies which transport layer protocol to use for sending SIP packets.
Value Range	<ul style="list-style-type: none"> • 0 (UDP) • 1 (TCP)
Default Value	0

SIP_ANM_DISPNAME

Value Format	Integer
Description	Specifies the text string to set as the display name in the "From" header when making anonymous calls.
Value Range	<ul style="list-style-type: none"> • 0 (Use normal display name) • 1 (Use "Anonymous" for display name) • 2 (Do not send a display name)
Default Value	1

SIP_ANM_USERNAME

Value Format	Integer
Description	Specifies the text string to set as the user name in the "From" header when making anonymous calls.

4.6.2 SIP Settings

Value Range	<ul style="list-style-type: none">• 0 (Use normal user name)• 1 (Use "anonymous" for user name)• 2 (Do not send a user name)
Default Value	0

SIP_ANM_HOSTNAME

Value Format	Boolean
Description	Specifies whether to set an anonymous host name in the "From" header when making anonymous calls.
Value Range	<ul style="list-style-type: none">• Y (Use "anonymous.invalid" for host name)• N (Use normal host name)
Default Value	N

SIP_DETECT_SSAF

Value Format	Boolean
Description	Specifies whether to enable SSAF for the SIP servers (registrar server, proxy server, and presence server).
Value Range	<ul style="list-style-type: none">• Y (Enable SSAF)• N (Disable SSAF) <p>Note</p> <ul style="list-style-type: none">• If set to "Y", the SIP-CS receives SIP messages only from the source addresses stored in the SIP servers (registrar server, proxy server, and presence server), and not from other addresses. However, if "SIP_OUTPROXY_ADDR" in 4.6.2 SIP Settings is specified, the SIP-CS also receives SIP messages from the source address stored in the SIP outbound proxy server.
Default Value	N

SIP_RCV_DET_HEADER

Value Format	Boolean
Description	Specifies whether to check the username part of the SIP URI in the "To" header when receiving the INVITE message with an incorrect target SIP URI.

Value Range	<ul style="list-style-type: none"> • Y (Enable username check) • N (Disable username check) <p>Note</p> <ul style="list-style-type: none"> • If set to "Y", the SIP-CS will return an error reply when it receives the INVITE message with an incorrect target SIP URI. • If set to "N", the SIP-CS will not check the username part of the SIP URI in the "To" header.
Default Value	N

SIP_CONTACT_ON_ACK

Value Format	Boolean
Description	Specifies whether to add the "Contact" header to SIP ACK message.
Value Range	<ul style="list-style-type: none"> • Y (Add the "Contact" header) • N (Do not add the "Contact" header)
Default Value	N

SIP_TIMER_B

Value Format	Integer
Description	Specifies the value of SIP timer B (INVITE transaction timeout timer), in milliseconds. For details, refer to RFC 3261.
Value Range	250–64000
Default Value	32000

SIP_TIMER_D

Value Format	Integer
Description	Specifies the value of SIP timer D (wait time for answer resending), in milliseconds. For details, refer to RFC 3261.
Value Range	0, 250–64000
Default Value	5000

SIP_TIMER_F

Value Format	Integer
Description	Specifies the value of SIP timer F (non-INVITE transaction timeout timer), in milliseconds. For details, refer to RFC 3261.
Value Range	250–64000

4.6.2 SIP Settings

Default Value	10000
---------------	-------

SIP_TIMER_H

Value Format	Integer
Description	Specifies the value of SIP timer H (wait time for ACK reception), in milliseconds. For details, refer to RFC 3261.
Value Range	250–64000
Default Value	32000

SIP_TIMER_J

Value Format	Integer
Description	Specifies the value of SIP timer J (wait time for non-INVITE request resending), in milliseconds. For details, refer to RFC 3261.
Value Range	0, 250–64000
Default Value	5000

ADD_TRANSPORT_UDP

Value Format	Boolean
Description	Specifies whether to add the attribute "transport=udp" to the SIP header URI.
Value Range	<ul style="list-style-type: none">Y (Add Transport UDP)N (Do not add Transport UDP)
Default Value	N

ADD_EXPIRES_HEADER

Value Format	Boolean
Description	Specifies whether to add an "Expires" header to REGISTER (adds an "expires" parameter to the "Contact" header).
Value Range	<ul style="list-style-type: none">Y (Add Expires Header)N (Do not add Expires Header)
Default Value	Y

SIP_HOLD_HOLDRECEIVE

Value Format	Boolean
--------------	---------

Description	Specifies whether to allow re-INVITE for calls on hold.
Value Range	<ul style="list-style-type: none"> • Y (Enable SIP Hold Receive) • N (Disable SIP Hold Receive)
Default Value	Y

SIP_ADD_DIVERSION

Value Format	Integer
Description	Specifies whether to add Diversion header information.
Value Range	0–2 <ul style="list-style-type: none"> – 0: Do not add Diversion header information – 1: Use own diversion information only for the Diversion header – 2: Add diversion information to existing Diversion header
Default Value	1

SIP_RESPONSE_CODE_DND

Value Format	Integer
Description	Selects the response code when a call is received in Do Not Disturb mode.
Value Range	400–699
Default Value	403

SIP_RESPONSE_CODE_CALL_REJECT

Value Format	Integer
Description	Selects the response code when a call is rejected.
Value Range	400–699
Default Value	603

SIP_FOVR_MODE

Value Format	Boolean
Description	Specifies whether INVITE/SUBSCRIBE will follow the REGISTER Failover result.
Value Range	<ul style="list-style-type: none"> • Y (INVITE/SUBSCRIBE will follow the REGISTER Failover result.) • N (INVITE/SUBSCRIBE will not follow the REGISTER Failover result.)
Default Value	N

SIP_FOVR_DURATION

Value Format	Integer
Description	Specifies the number of transmission times for the REGISTER method at the Failover destination.
Value Range	0–10
Default Value	0

SIP_403_REG_SUB_RTX

Value Format	Boolean
Description	Specifies whether or not to send a request when a "403 Forbidden" reply is received from the server in response to an INVITE or SUBSCRIBE.
Value Range	<ul style="list-style-type: none"> • \mathcal{Y} (Send) • \mathcal{N} (Do not send)
Default Value	\mathcal{N}

CSL_PC_LISTEN_PORT

Value Format	Integer
Description	Specifies the port number of the CS Maintenance Tool.
Value Range	1024–49151
Default Value	1102

Section 5

PS Registration

This section provides information about how to register S-PSs to SIP-CSs.

5.1 PS Registration from Web User Interface

This section explains how to register an S-PS via Web user interface programming.

Registering Extension Numbers and Extension Names for S-PSs

The screenshot shows the Panasonic SIP CS KX-UDS124 Web User Interface. The main navigation tabs are Status, Network, System, VoIP, Telephone, and Maintenance. The 'System' tab is selected, and the 'PS Registration' page is displayed. The page contains the following elements:

- System Menu:** Web Language, Administrator Password, Change User Password, Web Server Settings, Time Setting, Time Adjust Settings, CS Name, Air Settings, CS Management, Tree Survey, CS Monitor, PS Registration, - PS Settings.
- PS Registration Section:**
 - Instructions: "Please push the 'Stop PS Registration' button to stop on the way after starting PS Registration."
 - Buttons: Start PS Registration, Stop PS Registration.
 - Instructions: "Please push the 'Delete PS Registration' to delete registered PS."
 - Buttons: Delete PS Registration.
- PS Name / Number Table:**

No.	PS Name	Select Button	Phone Number	Wireless Status
1	<input type="text"/>	Line1 SIP Setting Line2 SIP Setting		Un Registered
2	<input type="text"/>	Line1 SIP Setting Line2 SIP Setting		Un Registered
3	<input type="text"/>	Line1 SIP Setting Line2 SIP Setting		Un Registered
	<input type="text"/>	Line1 SIP Setting		Un Registered

1. Log in to the Web user interface for the Super Master CS (→ see 2.1 Web User Interface Programming).
2. Click the [System] tab, and then select [PS Registration].
3. Enter an extension name in [PS Name].
4. Click [All Save].

5. Select **[Line1 SIP Setting]** or **[Line2 SIP Setting]**.

Note

- Some SIP servers allow only 1 extension number per telephone. For details, refer to your SIP server's documentation.

Panasonic
SIP CS KX-UDS124

Status | Network | **System** | VoIP | Telephone | Maintenance

Web Logout
Web Port Close

System

- Web Language
- Administrator Password
- Change User Password
- Web Server Settings
- Time Setting
- Time Adjust Settings
- CS Name
- Air Settings
- CS Management
- Tree Survey
- CS Monitor
- PS Registration
- PS Settings

SIP Settings - PS [Line 1]

Back

PS Name
PS Name

Phone Number
Phone Number
SIP URI

SIP Authentication
Authentication ID
Authentication Password

SIP Source Port
Source Port 5061 [1024-49151]

All Save Cancel

6. Enter the **[Phone Number]**, and enter **[Authentication ID]** and **[Authentication Password]** if necessary.
7. Click **[All Save]**.
8. Click **[Back]**.
9. Repeat steps 3 to 8 for each S-PS.

Note

- If the S-PS name is too long to display, the end of the name may not be displayed on the S-PS's standby screen.

Starting Registration Mode

After you have configured the S-PS name and SIP settings, follow the procedure below to register S-PSs.

Panasonic
SIP CS KX-UDS124

Status | Network | **System** | VoIP | Telephone | Maintenance

Web Logout
Web Port Close

System

- Web Language
- Administrator Password
- Change User Password
- Web Server Settings
- Time Setting
- Time Adjust Settings
- CS Name
- Air Settings
- CS Management
- Tree Survey
- CS Monitor
- PS Registration
- PS Settings

PS Registration - Start PS Registration





Back

PS Lists

Available PS		Selected PS
1 PanaTaro001	>> > < <<	

Next Cancel

5.1 PS Registration from Web User Interface

1. Click the **[System]** tab, click **[PS Registration]**, and then click **[Start PS Registration]**.
2. Select the S-PSs to be registered in **[Available PS]**, and then click .
To select all available S-PSs, click . To deselect S-PS(s), click  or .
3. Click **[Next]**.
4. Click **[OK]** to confirm registration.

Registering S-PSs

After entering PS Registration mode, follow the procedure below to register each S-PS.

For unregistered S-PSs

1. Display the standby screen below.



*1 The symbol for the center soft key (Menu) differs depending on the country/area.

2. Hold down  until "Please wait..." is displayed.

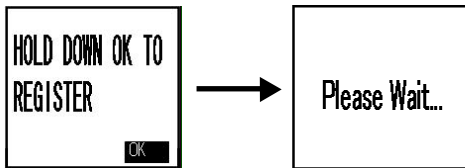

3. When registration has completed, "Registered" will be displayed.



For registered S-PSs

1. Enter the "Setting Handset" menu (→ see **Opening the Web Port in 2.1.1 Before Accessing the Web User Interface**).
2. Select "System Option" and then press .

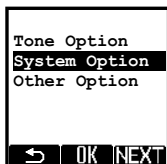

3. Select "Register H/S" and then press **OK**.

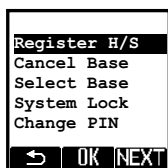

4. Select a base number and then press **OK**.

Note

- You can register four separate bases on your S-PS.

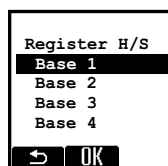

5. Hold down **OK** until "Please wait..." is displayed.

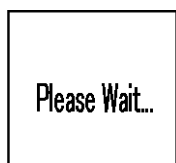

6. When registration has completed, "Registered" will be displayed.



Note

- You can register multiple S-PSs continuously. However, PS Registration mode will terminate if no registrations are detected within 2 minutes. All SIP-CSs controlled by the Super Master CS will enter PS Registration mode at the same time as the Super Master CS. You can register an S-PS to any of the SIP-CSs.
- When registering multiple S-PSs, perform the registration procedure on each S-PS individually. Performing the registration procedure on multiple S-PSs at the same time may result in an error. In this case, reperform the registration procedure.
- After registering S-PSs, the Web port will be closed (→ see **Opening the Web Port** in **2.1.1 Before Accessing the Web User Interface**).
- After registering S-PSs, S-PS firmware update may start automatically. During the firmware update, the S-PS may reboot up to 3 times. Therefore, you should not remove the battery/batteries of the S-PS.

Checking Progress

You can check registration progress on the [PS Registration] screen.

Panasonic
SIP CS KX-UDS124

Status | Network | **System** | VoIP | Telephone | Maintenance

Web Logout | Web Port Close

PS Registration
PS Registration Complete

System

- Web Language
- Administrator Password
- Change User Password
- Web Server Settings
- Time Setting
- Time Adjust Settings
- CS Name
- Air Settings
- CS Management
- Tree Survey
- CS Monitor
- PS Registration**
- PS Settings

PS Registration

Please push the "Stop PS Registration" button to stop on the way after starting PS Registration.

PS Registration

Please push the "Delete PS Registration" to delete registered PS.

PS Registration Delete

No.	PS Name	Select Button	Phone Number	Wireless Status
1	PanaTaro001	<input type="button" value="Line1 SIP Setting"/> <input type="button" value="Line2 SIP Setting"/>	1000	Registered
2		<input type="button" value="Line1 SIP Setting"/> <input type="button" value="Line2 SIP Setting"/>		Un Registered
3		<input type="button" value="Line1 SIP Setting"/> <input type="button" value="Line2 SIP Setting"/>		Un Registered
4		<input type="button" value="Line1 SIP Setting"/> <input type="button" value="Line2 SIP Setting"/>		Un Registered
5		<input type="button" value="Line1 SIP Setting"/>		Un Registered

If "Trying" is displayed on the left of the screen, you can check the registration status of each S-PS in the [Wireless Status] field. If "PS Registration Complete" is displayed on the left of the screen, all S-PSs that selected for registration were registered successfully.

Unregistering S-PSs

If you want to unregister a specified S-PS, follow the procedure below.

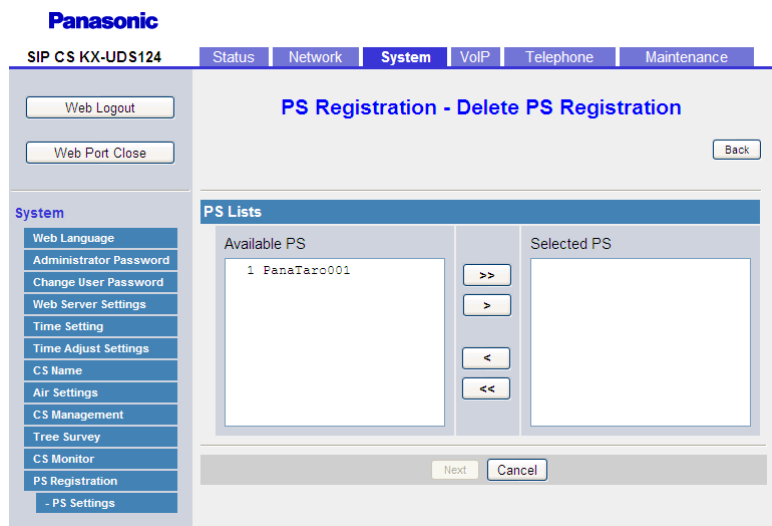

1. Click the **[System]** tab, click **[PS Registration]**, and then click **[Delete PS Registration]**.
2. Select the S-PSs to be unregistered in **[Available PS]**, and then click **>**.
To select all available S-PSs, click **>>**. To deselect S-PS(s), click **<** or **<<**.
3. Click **[Next]**.
4. Click **[OK]** to confirm unregistration.

Unregistering a Base System from the S-PS

If the S-PS was outside the coverage area or was turned off when the above-mentioned unregistration procedure was performed, you must unregister the base system manually.

1. Enter the "Setting Handset" menu.
2. Select "System Option" and then press **OK**.

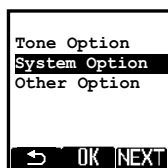

3. Select "Cancel Base" and then press **OK**.

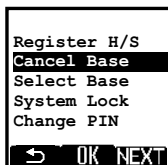

5.2 PS Registration using Provisioning

4. Select the base number for unregistration by pressing **▼**, and then press **OK**.

Note

- You can select multiple base numbers for unregistration if necessary.

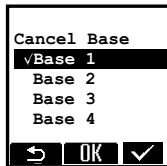

5. Select "yes" and then press **OK**.

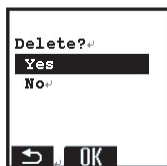

When unregistration has completed, "Deleted" will be displayed.

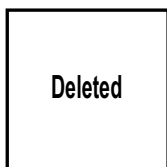

5.2 PS Registration using Provisioning

This section shows how to register the S-PS via configuration file programming.

You must prepare a configuration file (e.g., UserAccount.cfg) for each user account, as follows:

```
# Panasonic SIP Phone Standard Format File # DO NOT CHANGE THIS LINE!

# Setting for PS1
# 12 digits IPEI code for registering PS
IPEI_PS1="123456789012"
# Line1 Setting
PHONE_NUMBER_PS1_1="3331231"
SIP_AUTHID_PS1_1="userid1"
SIP_PASS_PS1_1="userpass1"
# Line2 Setting
PHONE_NUMBER_PS1_2="3331232"
SIP_AUTHID_PS1_2="userid2"
```

The IPEI code is a unique number throughout the world. Therefore, you can register S-PSs remotely by stating the IPEI in a configuration file.

After the above configuration file is provisioned, all SIP-CSs enter PS Registration mode until the specified S-PS registration is performed.

You can confirm the IPEI code of your S-PS either from the label of its package or via the S-PS's system option menu.

Confirming the S-PS's IPEI code

1. Enter the "Setting Handset" menu (→ see **Opening the Web Port in 2.1.1 Before Accessing the Web User Interface**).
2. Select "System Option" and then press **OK**.

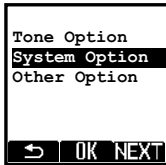

3. Select "H/S Information" and then press **OK**.

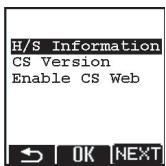

4. Confirm the IPEI code (lower item).

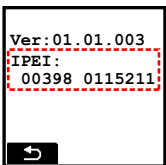

Section 6

Useful Telephone Functions

This section describes various phone number settings, such as copying the phone number settings dial plan, and the phonebook import/export function.

6.1 Phonebook Import and Export

This section explains how to import and export phonebook data. S-PS phonebook data includes names and phone numbers.

Phonebook data on the S-PS can be exported, edited with editor tools, and imported again. In addition, phonebook data created with other software can be imported into the S-PS.

You can use the phonebook import and export functions as follows.

Editing Phonebook Data on a PC

The phonebook data stored on the S-PS can be edited using a program such as Microsoft Excel® spreadsheet software. For details about the operation, see **6.1.2 Editing with Microsoft Excel**.

You can export the phonebook data to the PC, edit the exported file using appropriate software, and then import it into the S-PS.

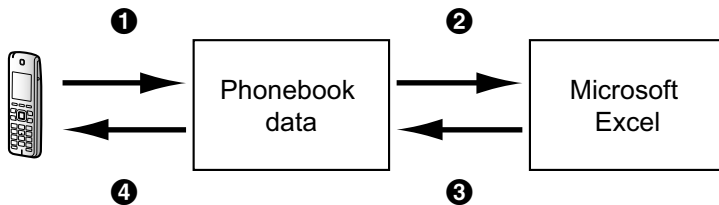

Importing Address Book Data from a PC

You can import address book data stored in programs, such as Microsoft Outlook® messaging and collaboration client, into the S-PS.

First, export address book data from the e-mail software to a program such as Microsoft Excel, edit it as necessary, and then import the exported data into the S-PS.

For details about the operation, see **6.1.3 Exporting Data from Microsoft Outlook**.

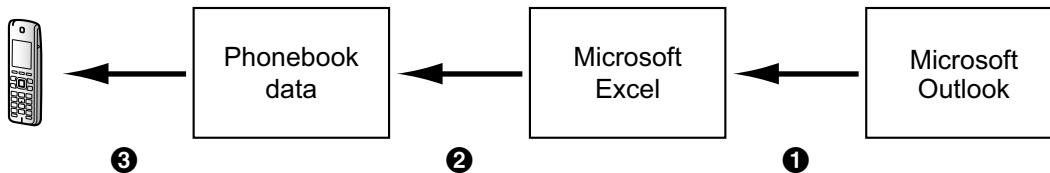

Backing up Phonebook Data

You can export the phonebook data from the S-PS to a PC and keep the file as a backup in case of data loss or for use when exchanging the S-PS.

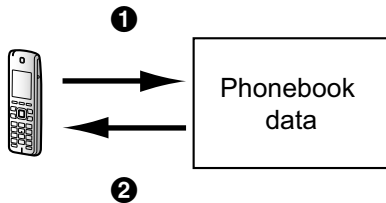

Importing the Same Phonebook Data to other S-PSs

You can export the phonebook data created on an S-PS to a PC, and then import it into other S-PSs.

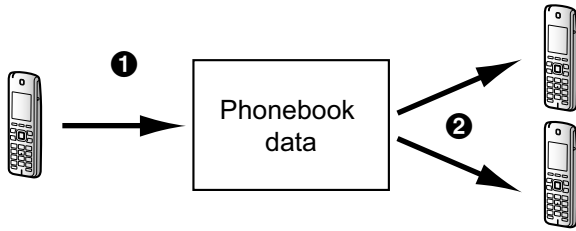

You can also import phonebook data created on a PC to other S-PSs.

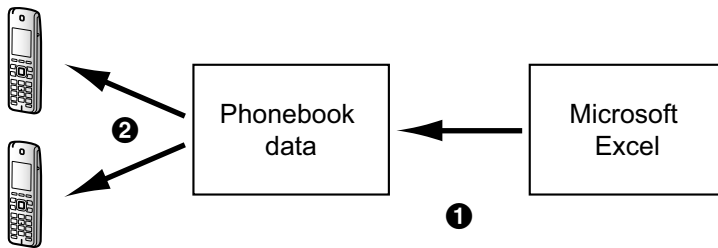

Import/Export File Format

The file format used for importing and exporting the phonebook data is "TSV". When importing or exporting using Microsoft Excel, "CSV (Comma-separated Value)" is generally used as the file format.

A phonebook entry in the S-PS has 9 fields. An entry in the phonebook data is represented in text as "reserved <TAB> name <TAB> reserved <TAB> phone number <TAB> phone number <TAB> phone number <TAB> phone number <TAB> phone number <TAB> reserved <line break>".

The text data can be edited using any text editing software that supports UTF-16 encoding with a BOM and little endian byte ordering. When you save the text file, it must be saved using the same format, or the text might become garbled.

Phonebook Data in Text Format

1	2	3	4	5	6	7	8	9	10	11	12	13	14	15	16	17
		Aaron MacDowel				501		1234001								
		Barbara Nicolls				502		1234002								
		Carl O'Brien				503		1234003								
		Dorothy Parker						1234004								
....	
....	

- 1 Reserved for KX-NS1000 System Phonebook Download
- 2 Tab
- 3 Name (up to 24 characters)
- 4 Tab
- 5 Reserved
- 6 Tab
- 7 Phone number (up to 32 digits)
- 8 Tab
- 9 Phone number (up to 32 digits)
- 10 Tab
- 11 Phone number (up to 32 digits)
- 12 Tab
- 13 Phone number (up to 32 digits)
- 14 Tab
- 15 Phone number (up to 32 digits)
- 16 Tab
- 17 Reserved

6.1.1 Import/Export Operation

The following procedures explain how to import phonebook data to S-PSs, and how to export phonebook data from S-PSs to a PC through the Web user interface.

For details about the settings, see **2.6.10 Import Phonebook - All**, **2.6.11 Import Phonebook - PS** or **2.6.13 Export Phonebook - PS**.

To import phonebook data to all S-PSs immediately

1. Click the **[Telephone]** tab, and then click **[Import Phonebook]**.
2. Click **[All]** to select all S-PSs.
3. Select **[Direct]** for **[Import Mode]**.
4. In **[File Name]**, enter the full path to the file that you want to import, or click **[Browse]** to select the phonebook data file that you want to import.
5. Click **[All Import]**.

To import phonebook data to all S-PSs at a set time

1. Click the **[Telephone]** tab, and then click **[Import Phonebook]**.
2. Click **[All]** to select all S-PSs.
3. Select **[Appoint Date/Time]** for **[Import Mode]**.
4. Input **[Date]** and **[Time]** for **[Import Time Setting]**.

5. In **[File Name]**, enter the full path to the file that you want to import, or click **[Browse]** to select the phonebook data file that you want to import.
6. Click **[All Import]**.

To import phonebook data to one S-PS

1. Click the **[Telephone]** tab, and then click **[Import Phonebook]**.
2. Click a numbered tab to find the appropriate S-PS, and then click **[Import Phonebook]** for that S-PS.
3. In **[File Name]**, enter the full path to the file that you want to import, or click **[Browse]** to select the phonebook data file that you want to import.
4. Click **[Import]**.

To export the phonebook data from an S-PS

1. Click the **[Telephone]** tab, and then click **[Export Phonebook]**.
2. Click a numbered tab to find the appropriate S-PS, and then click **[Export Phonebook]** for that S-PS.
3. Click **[Export]**.
4. On the "Now Processing File Data" screen, click the text "HERE" in the displayed message, or wait until **File Download** window appears.

Note

- Depending on the security settings of your Web browser, pop-up menus might be blocked. If the file cannot be exported successfully, try the export operation again or change the security settings of your Web browser.

5. Click **[Save]** on **File Download** window.
6. On the **Save As** window, select a folder to save the exported phonebook data to, enter the file name in **File name**, select **TSV File** for **Save as type**, and click **Save**.
If the file is downloaded successfully, the **Download complete** window appears.
7. Click **Close**.
8. To exit the operation, click the text "HERE" in the displayed message.
The **[Export Phonebook]** screen returns.

Note

- Make sure that the import source or destination S-PS is in standby mode.
- The phonebook for an S-PS has the following limitations:
 - A maximum of 500 phone numbers can be stored in the S-PS. If the S-PS already has phonebook data, it accepts up to the 500th number, including the existing numbers. The rest of the numbers will not be imported.
 - The name can contain up to 24 characters.
 - The phone number can contain up to 32 digits.
 - Phonebook entries exceeding the characters or digits limits cannot be imported properly.
- If the export is interrupted by an operation on the SIP-CS/S-PS, only the data that has been successfully exported before the interruption is exported to a file.
- When an incoming call arrives at an S-PS which is importing/exporting phonebook data, the S-PS does not ring and the call is not displayed. However, the call is stored in the incoming call log.

6.1.2 Editing with Microsoft Excel

You can edit exported phonebook data on a PC with software such as Microsoft Excel. You can then import the phonebook data into S-PSs.

To open the phonebook data on a PC

1. Open Microsoft Excel.

6.1.2 Editing with Microsoft Excel

2. Click **Office Button**, and then **Open**.

Note

- Make sure to open a TSV file in this procedure. If you change the extension of a TSV file to ".csv", the file will open by simply double-clicking it. However, the character encoding of the file might not be recognized properly, resulting in garbled characters, or the phone numbers might be recognized as numbers, resulting in data alteration.

3. Select **All Files** for the file type, select the exported phonebook data file, and click **Open**.

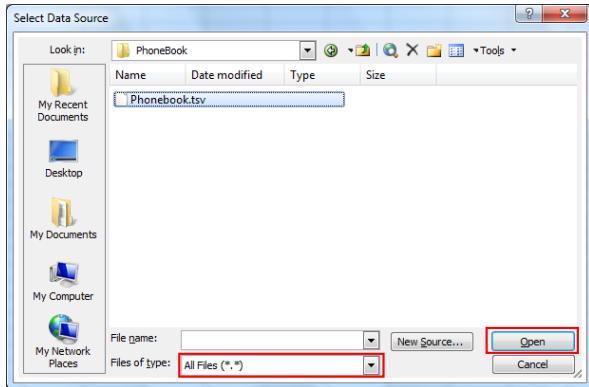

4. On the **Text Import Wizard - Step 1 of 3** window, click **Next**.

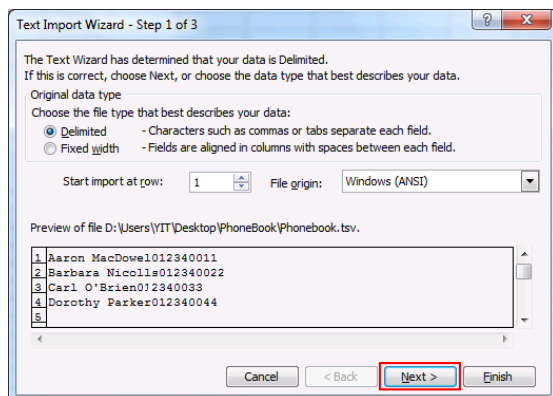

Note

- Regardless of what is selected for **File origin**, the file will be processed normally if the format is appropriate.

- On the **Text Import Wizard - Step 2 of 3** window, select **Tab** for **Delimiters**, and then click **Next**.

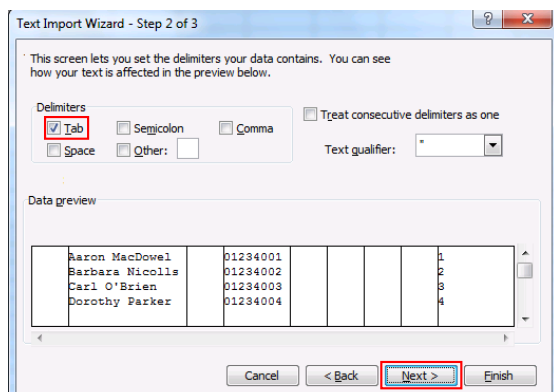

- On the **Text Import Wizard - Step 3 of 3** window, select all columns in **Data preview**, select **Text** in **Column data format**, and then click **Finish**.
The TSV file will be opened.

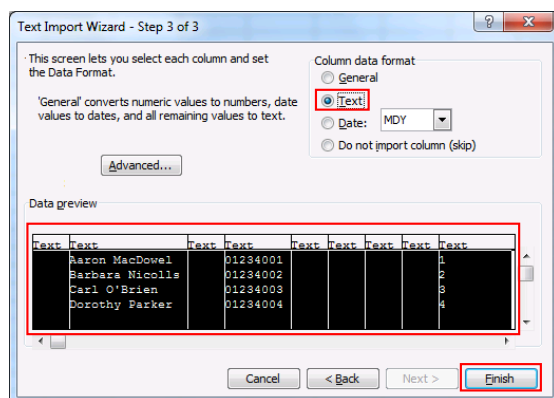

Note

- Phone numbers must be treated as text strings. Otherwise, a "0" at the beginning of a phone number might disappear when exported.

To save the phonebook data for importing to the S-PS

- After editing the phonebook entries, click **Office Button**, and then **Save As**.
- Enter a file name in **File name**, and select **Unicode Text** in **Save as type**.
The file will be saved in UTF-16 little endian with a BOM. Fields will be separated by tabs.
- Click **Save**.
A message warning you about file compatibility will be displayed.
- Click **Yes**.
The file will be saved as a Unicode text file, with the fields separated by tabs.

Note

- The procedure may vary depending on the software version of Microsoft Excel. Therefore, files exported and imported between the S-PS and Microsoft Excel are not always compatible with each other.
- For KX-NS1000 users, if you find numbers in the first column of the exported TSV record data, they are records downloaded from the KX-NS1000 System Phonebook. These files are updated through the KX-NS1000 automatically so do not modify this data.

- For KX-NS1000 users, after importing a phonebook TSV file containing KX-NS1000 System Phonebook records in the first column, the previous System Phonebook records are deleted from the S-PSs.

6.1.3 Exporting Data from Microsoft Outlook

You can export address book data stored in programs such as Microsoft Outlook, and then edit the exported data with a program such as Microsoft Excel in order to import it to the S-PS.

To export the Microsoft Outlook address book data

1. In Microsoft Outlook, click **File**, and then click **Import and Export**.
2. Select **Export to a file**, and click **Next**.
3. Select **Tab Separated Values (Windows)**, and click **Next**.
4. Select **Contacts**, and click **Next**.
5. Click **Browse**, select a folder, and then enter the file name to export the data to.
6. Click **OK**.
7. On the **Export to a File** window, click **Next**.
8. Click **Map Custom Fields**.
9. Clear all items in the **To** list by clicking **Clear Map**. Then, drag only **Last Name** and **Business Phone** from the **From** list to the **To** list, and click **OK**.
10. On the **Export to a File** window, click **Finish**.
The data will be exported.

Note

- You can export data from Microsoft Outlook Express by using a similar procedure. It is also possible to export data from other applications that are compatible with Microsoft Excel.
- You can open the exported file in Microsoft Excel, and then import it to the S-PS. For details, see **6.1.2 Editing with Microsoft Excel**.
- First and middle names are not exported using this procedure. You can export all necessary items and edit the entry before importing them to the S-PS.
- In the file exported from Microsoft Outlook, fields are separated by tabs and encoded using the default character encoding for your operating system.

6.2 Dial Plan

The dial plan settings control how numbers dialed by the user are transmitted over the network. Dial plan settings can be configured for each S-PS. These settings can be programmed either through the Web user interface (→ see **2.6.3.3 Dial Plan**) or by configuration file programming (→ see **4.6.1 Call Control Settings**).

[Dial Plan Flowchart]

When a user dials a single digit on an S-PS, the following sequence of events begins.

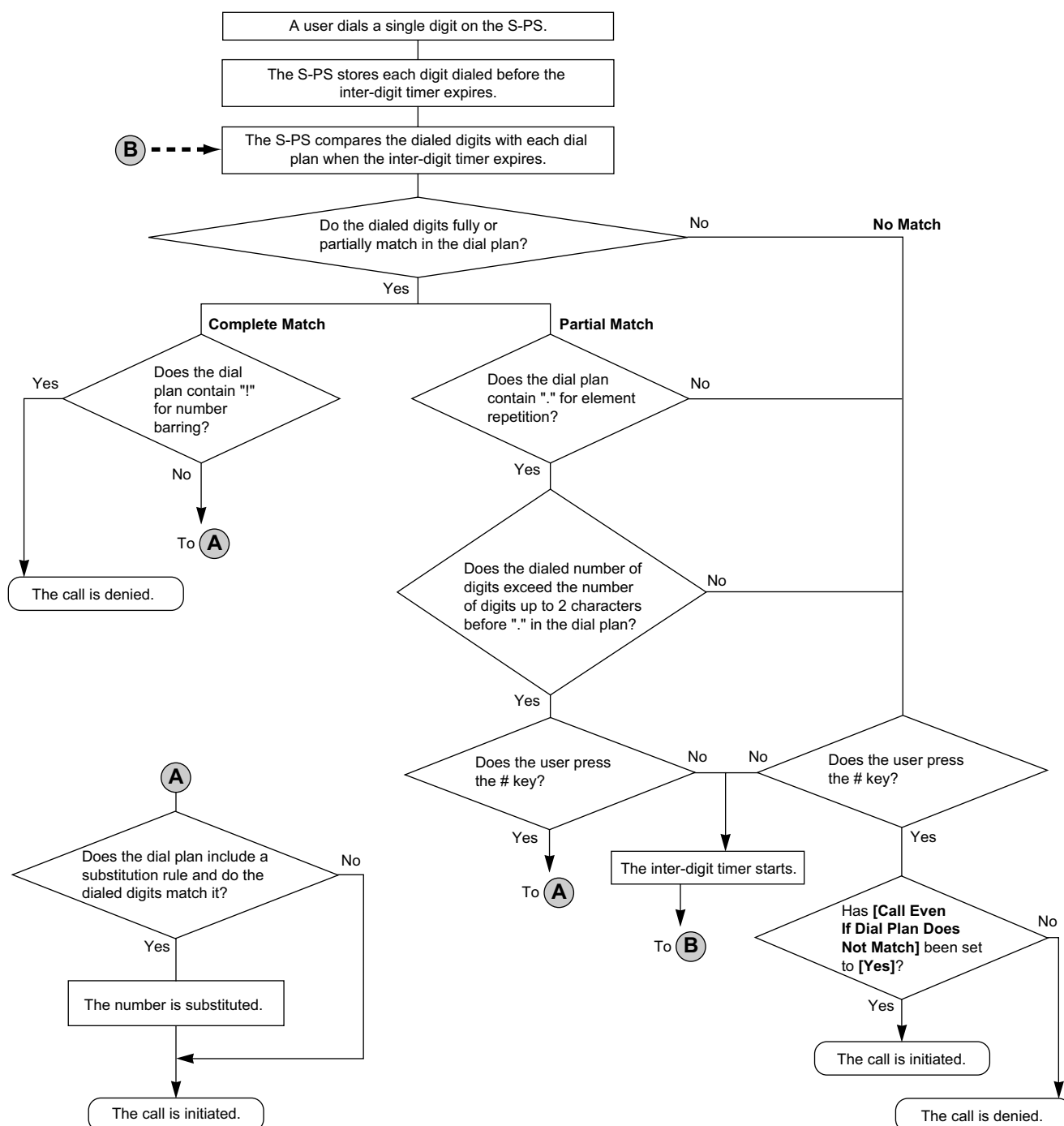

6.2.1 Dial Plan Settings

To set Dial Plan

1. In the Web user interface, click the **[Telephone]** tab, and then click **[Call Control]**.
2. Click a numbered tab to find the appropriate S-PS, and then click **[PS Call Control]** for that S-PS.
3. In **[Dial Plan]**, enter the desired dial format.

The dial plan settings can be configured for each S-PS.

6.2.1 Dial Plan Settings

For details about available characters for the dial format, see **Available Values for the Dial Plan Field** in this section.

4. Select **[Yes]** or **[No]** for **[Call Even If Dial Plan Does Not Match]**.

- If you select **[Yes]**, the call will be made even if the user dials a phone number that does not match the dial format in **[Dial Plan]**.
- If you select **[No]**, the call will be made only if the user dials a phone number that matches the dial format in **[Dial Plan]**.

Note

- For details about configuring these settings by configuration file programming, see "DIAL_PLAN" and "DIAL_PLAN_NOT_MATCH_ENABLE" in **4.6.1 Call Control Settings**.

Available Values for the Dial Plan Field

The following table explains which characters you can use in the dial format, and what the characters mean.

Element	Available Value	Description
String	0–9, [, -,], <, :, >, *, #, !, S, s, T, t, X, x, ., , +	You can enter dial plan descriptions using a combination of the characters listed as available values.
Digit	0–9, *, #, +	Example: "123" If the dialed phone number is "123", the call is made immediately.
Wildcard	X, x	Example: "12xxxxx" If the dialed phone number is "12" followed by any 5-digit number, the call is made immediately.
Range	[]	Example: "[123]" If the dialed phone number is either one of "1", "2", or "3", the call is made immediately.
Subrange	-	Example: "[1-5]" If the dialed phone number is "1", "2", "3", "4", or "5", the call is made immediately. <ul style="list-style-type: none">• A subrange is only valid for single-digit numbers. For example, "[4-9]" is valid, but "[12-21]" is invalid.
Repeat	.	Example: "1." If the dialed phone number is "1" followed by zero or more "1"s (e.g., "11", "111"), the call is made.
Substitution	<(before):(after)>	Example: "<101:9999>" If the dialed phone number is "101", "101" is replaced by "9999", and then the call is made immediately.
Timer	S, s (second)	Example: "1x.S2" If the dialed phone number begins with "1", the call is made after a lapse of 2 seconds. <ul style="list-style-type: none">• The number (0–9) followed by "S" or "s" shows the duration in seconds until the call is made.

Element	Available Value	Description
Macro Timer	T, t	Example: "1x.T" If the dialed phone number begins with "1", the call is made after a lapse of "T" seconds. <ul style="list-style-type: none"> The value of "T" or "t" can be configured through the Web user interface (→ see [Timer for Dial Plan] in 2.6.1.1 Call Control).
Reject	!	Example: "123xxx!" If the dialed phone number is "123" followed by 3 digits, the call is not made.
Alternation		Example: "1xxxx 2xxx" If the dialed phone number is "1" followed by 4 digits, or "2" followed by 3 digits, the call is made immediately. You can use this element to specify multiple numbers.

Note

- You can enter up to 500 characters in [Dial Plan].
- You can assign up to 40 dial plans separated by "|" in [Dial Plan].
- You can assign up to 32 digits per dial plan in [Dial Plan].
- After the user completes dialing, the S-PS immediately sends all the dialed digits if [Call Even If Dial Plan Does Not Match] is set to [Yes] in the Web user interface or if "DIAL_PLAN_NOT_MATCH_ENABLE" is set to "n" in a configuration file. The S-PS recognizes the end of dialing as follows:
 - The inter-digit timer expires (→ see [Inter-digit Timeout] in 2.6.1.1 Call Control in the Web user interface or "INTDIGIT_TIM" in 4.4.1 Call Control Settings in the configuration file).
 - The user presses the # key.
 - The call is initiated after going off-hook (pre-dial).

Dial Plan Example

The following example shows dial plans containing character sequences separated by "|".
Example: "[2346789]11|01[2-9]x.|[2-9]xxxxxxxx"

Complete Match:

Example: "[2346789]11|01[2-9]x.|[2-9]xxxxxxxx"

- If the dialed phone number is "211", "911" and so on, the call is made immediately.

Example: "[2346789]11|01[2-9]x.|[2-9]xxxxxxxx"

- If the dialed phone number is "2123456789", "5987654321" and so on, the call is made immediately.

Partial Match (when the dial plan contains "."):

Example: "[2346789]11|01[2-9]x.|[2-9]xxxxxxxx"

- If the dialed phone number is "01254", "012556" and so on, the call is made after the inter-digit timer expires.

Partial Match (when the dial plan does not contain "."):

Example: "[2346789]11|01[2-9]x.|[2-9]xxxxxxxx"

- If the dialed phone number is "21", "91" and so on when [Call Even If Dial Plan Does Not Match] is set to [Yes], the call is made after the inter-digit timer expires.
- If the dialed phone number is "21", "91" and so on when [Call Even If Dial Plan Does Not Match] is set to [No], the call is denied after the inter-digit timer expires.

6.3.1 Flexible Button Settings

Example: "[2346789]11|01[2-9]x.[2-9]xxxxxxxxx"

- If the dialed phone number is "21234567", "598765432" and so on when **[Call Even If Dial Plan Does Not Match]** is set to **[Yes]**, the call is made after the inter-digit timer expires.
- If the dialed phone number is "21234567", "598765432" and so on when **[Call Even If Dial Plan Does Not Match]** is set to **[No]**, the call is denied after the inter-digit timer expires.

No Match:

Example: "[2346789]11|01[2-9]x.[2-9]xxxxxxxxx"

- If the dialed phone number is "0011", "1011" and so on when **[Call Even If Dial Plan Does Not Match]** is set to **[Yes]**, the call is made after the inter-digit timer expires.
- If the dialed phone number is "0011", "1011" and so on when **[Call Even If Dial Plan Does Not Match]** is set to **[No]**, the call is denied.

6.3 Flexible Buttons

You can customize the flexible buttons on the S-PS. They can then be used to make or receive outside calls or as feature buttons. These settings can be programmed either through the Web user interface (→ see **2.6.6 Button Settings - PS**) or by configuration file programming (→ see **4.4.5 Flexible Button Settings**).

Note

- If the flexible button settings for an S-PS are changed through the Web user interface, the calls via the target S-PS will be disconnected.
- This feature may not be supported on your phone system.

The following types of flexible buttons are available:

Button	Description	Lamp Indication
DN	<p>Used to seize the line assigned to the DN (Directory Number) button. When a call arrives at the DN button, pressing the button answers the call.</p> <p>Notice</p> <ul style="list-style-type: none"> • At least 2 DN buttons must be assigned to each line. If DN buttons are not assigned, calls cannot be made or answered. <p>Note</p> <ul style="list-style-type: none"> • The shared line (shared call) feature is an optional feature and may not be supported on your phone system. 	<p>Off: Idle</p> <p>Green on: The extension is on a call using the DN button.</p> <p>Flashing green rapidly: The DN extension is receiving an incoming call.</p> <p>Flashing green slowly: A call is on hold at the DN extension.</p> <p>Red on: A shared line is in use or on hold (private).</p> <p>Flashing red slowly: A shared line is on hold (normal).</p>
One-Touch	Used to access a desired party or system feature using the One-Touch Dialing feature.	—

6.3.1 Flexible Button Settings

To set Flexible Buttons

1. In the Web user interface, click the **[Telephone]** tab, and then click **[Button Settings]**.
2. Click a numbered tab to find the appropriate S-PS, and then click **[Button Settings]** for that S-PS.

3. Enter settings as described in the following table.
When it is necessary to set both parameter 1 and parameter 2, enter a comma between the values.

Button	Parameter 1		Parameter 2	
	Description	Value	Description	Value
DN	Ringtone ^{*1}	(1–32)	Line No.	1–2
One-Touch	Phone Number	Up to 32 digits	–	–

*1 S-PSs do not support this feature. However, a value must be set before the comma when configuring a DN button.

Note

- For details about configuring these settings by configuration file programming, see **4.4.5 Flexible Button Settings**.

[Setting Example]

The following screen shows an example of setting flexible buttons.

Panasonic
SIP CS KX-UDS124

Web Logout | Web Port Close | Back

Telephone | Call Control | **Button Settings** | Tone Settings | Telephone Settings | Import Phonebook | Export Phonebook

Button Settings

PS Name: 001

No.	Type	Parameter	Label Name
1.	DN	1,1	DN1
2.	DN	1,1	DN1
3.	DN	1,1	DN1
4.	DN	1,1	DN1
5.	DN	2,2	DN2
6.	DN	2,2	DN2
7.	DN	2,2	DN2
8.	DN	2,2	DN2
9.	One-Touch	0123456789	Office
10.	One-Touch	1112223333	Office 2
11.	One-Touch	012343333	Home
12.	One-Touch	0123232323	Home 2

All Save | Cancel

Description:

- Buttons 1, 2, 3 and 4 are set to make/receive calls on line 1.
- Buttons 5, 6, 7 and 8 are set to make/receive calls on line 2.
- Buttons 9, 10, 11 and 12 are set to make calls to a certain destination using the One-Touch Dialing feature.

6.4 Copying Flexible Button Settings to Other S-PSs

You can copy the flexible button settings that you have customized for an S-PS and apply them to other S-PSs through the Web user interface programming. For details about the settings, see **2.6.7 Button Settings - Copy & Paste**.

To copy the source settings to the desired S-PS

1. In the Web user interface, click the **[Telephone]** tab, and then click **[Button Settings]**.
The **[Button Settings]** screen appears.
2. Click a numbered tab to find the S-PS whose settings you want to copy, and then click **[Copy & Paste]** for that S-PS.
The **[Button Settings - Copy & Paste]** screen appears.
3. Select the S-PSs to have settings copied to in **[Available PS]**, and then click .
To select all available S-PSs, click . To deselect S-PS(s), click or .
4. Click **[Copy & Paste]**.
The flexible button settings will be applied to the other S-PS(s).

Section 7

Firmware Update

This section explains how to update the firmware of the SIP-CSs/S-PSs.

7.1 Firmware Update Overview

You can update the firmware of both SIP-CSs and S-PSs.

The updating mechanism is different depending on whether you are using configuration file programming or Web user interface programming.

Updating SIP-CS Firmware

Web user interface programming

After you upgrade the firmware of the Super Master CS, the Super Master CS distributes the firmware to all other Master CSs, and then the Master CSs distribute the firmware to all Slave CSs.

The update timing can be programmable via Web user interface programming.

Configuration file programming

After a configuration file that includes firmware update information is acquired by the Super Master CS, configuration information is distributed to all other SIP-CSs.

After that, each SIP-CS will acquire the firmware file to update individually.

The SIP-CS will reboot if the firmware is updated successfully.

Updating S-PS Firmware

The downloaded firmware file consists of SIP-CS firmware and S-PS firmware. These two kinds of firmware are combined into one file.

Firmware Update File

SIP-CS Firmware
S-PS Firmware

After the SIP-CS's firmware is updated, the S-PS will update its firmware wirelessly if the firmware version is different from current version.

The S-PS will reboot if the firmware is updated successfully.

7.2 Firmware Server Setup

No special server is necessary for the firmware update. You can use an HTTP, HTTPS, FTP, or TFTP server as the firmware server by simply setting its URL.

7.3 Firmware Update Settings





Firmware updates are provided by the manufacturer when necessary.

The firmware update will be executed by setting the corresponding parameters using configuration file programming (→ see **4.2.4 Firmware Update Settings**) or Web user interface programming (→ see **2.7.3 Firmware Maintenance**).

Note

- After firmware updates are complete for the SIP-CSs, the newer firmware will be applied to the S-PSs.
- If the firmware version of an S-PS is older, the firmware updates for the S-PS will be executed to register to the SIP-CS.
- If you are using a language other than English, the display language may unexpectedly change to English during an S-PS firmware update. One of the following messages may be displayed:

Displayed Message	Description
<ERASING>	Data is being erased.
<WRITING>	Data is being written.
<WRITE OK>	Data writing was successful.
<ERROR 1>	A deletion error occurred.
<ERROR 2>	A writing error occurred.
<Charge Battery>	Charge the S-PS's battery.

- When executing firmware updates for the S-PSs, make sure of the following:
 - The target S-PSs are on the charger with the power ON.
 - The S-PSs' batteries have enough charge remaining ( or  is recommended).
 - The S-PSs are located where the radio signal is strong ( or  is recommended).
 - The S-PSs are in standby mode.
- If automatic update is enabled and the S-PS firmware update does not start automatically after the SIP-CS firmware update, turn the S-PS off and on.

The following shows the parameters and the setting procedures:

Firmware Update Enable/Disable

- In a configuration file, add the line, `FIRM_UPGRADE_ENABLE="Y"`.
- In the Web user interface, click the **[Maintenance]** tab, click **[Firmware Maintenance]**, and then select **[Yes]** for **[Enable Firmware Update]**.

Firmware Version Number

- In a configuration file, specify the new version number in "`FIRM_VERSION`".

Automatic Update

- In a configuration file, add the line, `PS_FIRM_UPGRADE_AUTO="Y"`.

7.4 Executing Firmware Update

- In the Web user interface, click the **[Maintenance]** tab, click **[Firmware Maintenance]**, and then select **[Automatic]** for **[PS Update Type]**.

Firmware Server URL

- In a configuration file, specify the URL in "FIRM_FILE_PATH".
- In the Web user interface, click the **[Maintenance]** tab, click **[Firmware Maintenance]**, and then enter the URL in **[Firmware File URL]**.

Configuration Parameter Example

By setting the parameters as shown in the following example, the SIP-CS will automatically download the firmware file from the specified URL, "http://firm.example.com/firm/01.050.fw", and perform the update operation if the currently used firmware version is older than 01.050.

Example

```
FIRM_UPGRADE_ENABLE="Y"  
FIRM_VERSION="01.050"  
PS_FIRM_UPGRADE_AUTO="Y"  
FIRM_FILE_PATH="http://firm.example.com/firm/01.050.fw"
```

7.4 Executing Firmware Update

After configuring the firmware update settings for the Super Master CS in the configuration file, the Super Master CS distributes configuration information to all other SIP-CSs. The firmware of each SIP-CS is updated when it receives the configuration information. The firmware update procedure of each SIP-CS is detailed below.

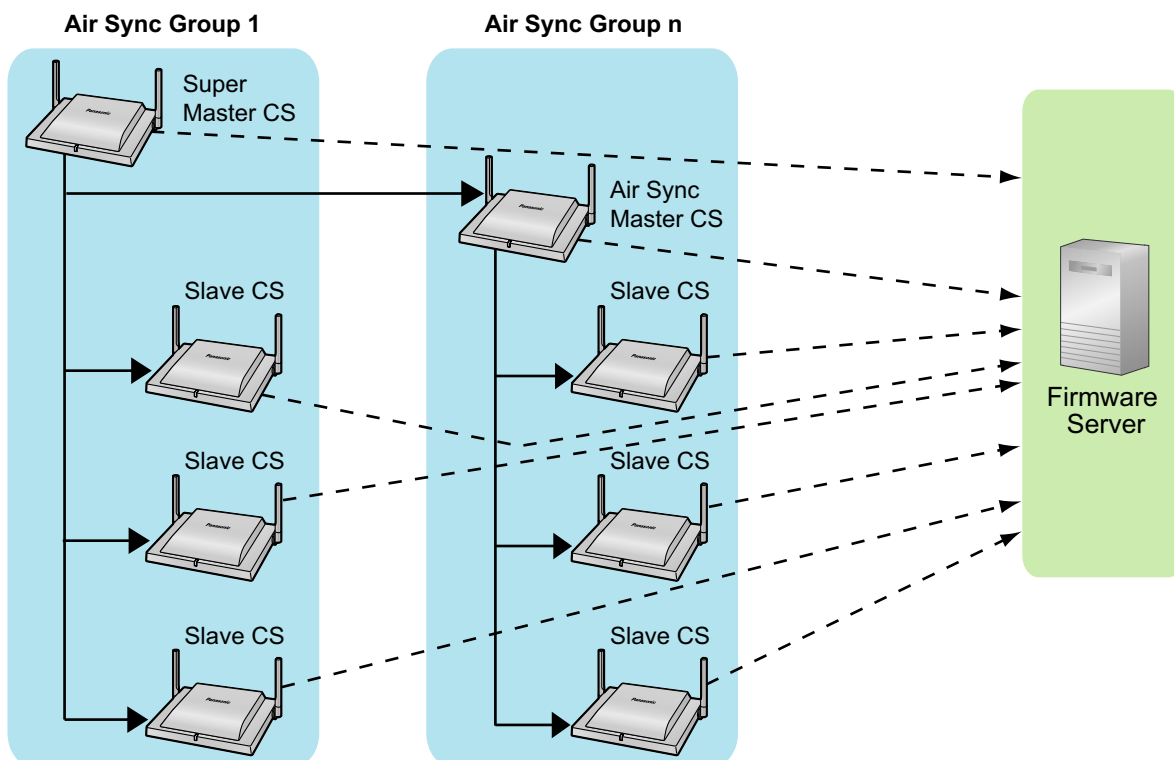

The firmware update process of each SIP-CS

Step 1

The SIP-CS downloads a configuration file from the provisioning server.

- For details about setting the timing of when configuration files are downloaded, see **3.2.4 Downloading Configuration Files.**

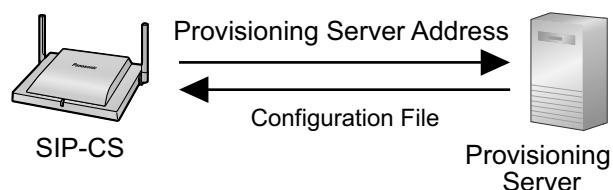

Step 2

The SIP-CS compares the version number of the firmware in the configuration file to the SIP-CS's current firmware version.

(In this example, the SIP-CS is using version 01.000 and the configuration file specifies version 01.050.)

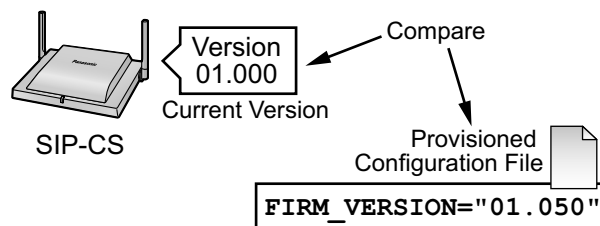

Step 3

When a newer firmware version is specified in the configuration file, the SIP-CS will download the firmware from the address specified under "**FIRM_FILE_PATH**" in the configuration file.

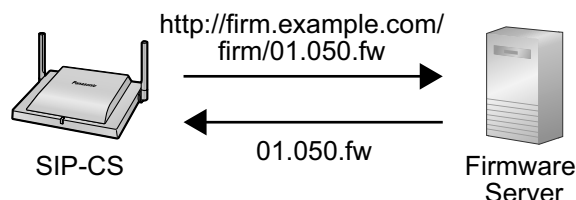

Step 4

Once the newer firmware is downloaded, it is applied to the SIP-CS and the SIP-CS automatically restarts.

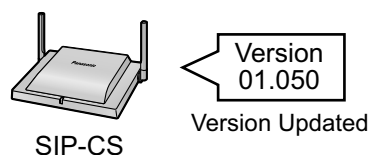

Step 5

The firmware updates for the S-PSs will be executed.

7.5 Local Firmware Update

When an updated version of the firmware is provided on a Web site or other means, you can perform the firmware update manually using Web user interface programming.

After the firmware is uploaded to the Super Master CS, the Super Master CS distributes the firmware to all other SIP-CSs.

7.5 Local Firmware Update

For details about the local firmware update, see 2.7.4 All Firmware Update.

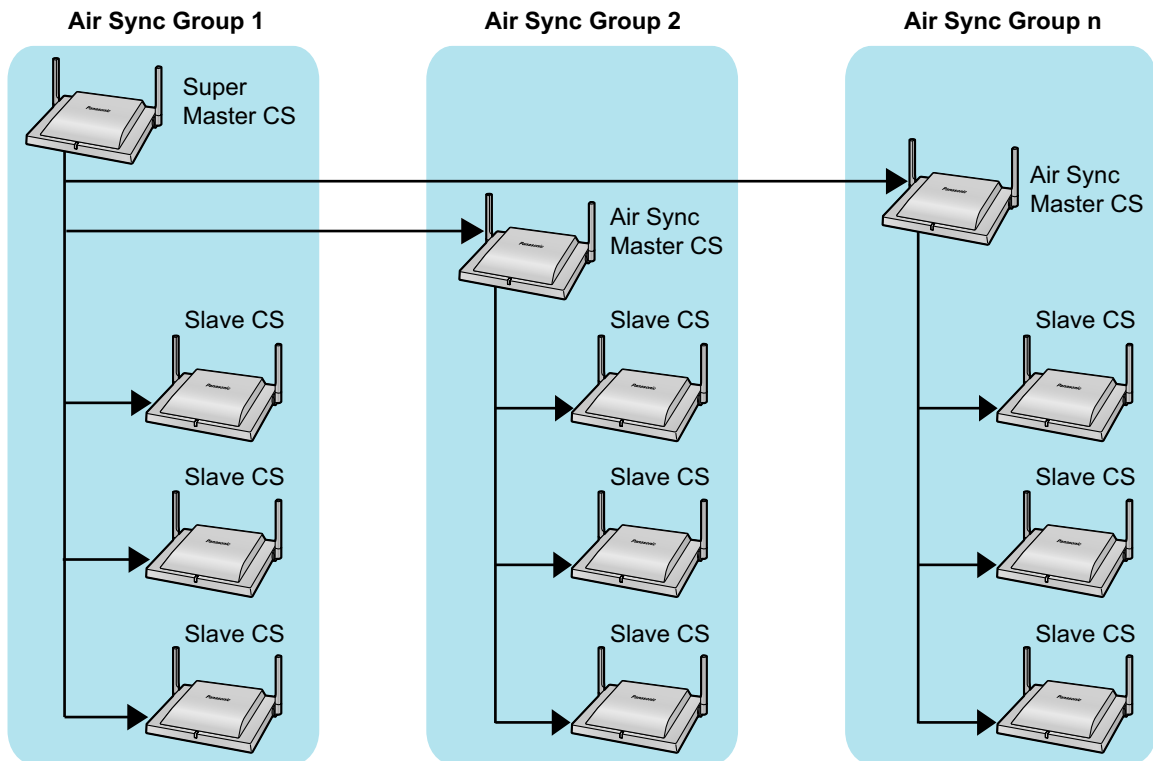

To manually update the firmware immediately

1. Click the **[Maintenance]** tab, and then click **[All Firmware Update]**.
2. Select **[Direct]** for **[Update Mode]**.
3. Click **[Browse]**, select the folder where the firmware file is stored, and specify the firmware file on your PC.
4. Click **[All Update Firmware]**.

To manually update the firmware at a set time

1. Click the **[Maintenance]** tab, and then click **[All Firmware Update]**.
2. Select **[Appoint Date/Time]** for **[Update Mode]**.
3. Input **[Date]** and **[Time]** for **[Import Time Setting]**.
4. Click **[Browse]**, select the folder where the firmware file is stored, and specify the firmware file on your PC.
5. Click **[All Update Firmware]**.

Section 8

How to Backup and Restore Configurations

This section provides information about how to backup and restore Super Master CS configurations.

8.1 How to back up and restore configuration data

It is recommended to keep a backup of Super Master CS configuration data.

The backup data is useful when restoring the same configuration data to the Super Master CS when it must be re-installed due to a hardware error, etc.

The following data can be backed up and restored:

- Standard configuration data
- Product configuration data
- Master configuration data
- System configuration data
- Web settings
- Internal management data (e.g., Air Sync settings, PS registration settings, telephone parameters, etc)

Notice

The following data cannot be backed up or restored:

- Logs
- Pre-provisioning data
- Certifications

Note

- If the firmware version of the Super Master CS differs from that of the backup data, you cannot restore the configuration data.

Follow the procedure below to back up and restore the configuration data of SIP-CSs via the Web user interface.

Backing up configuration data

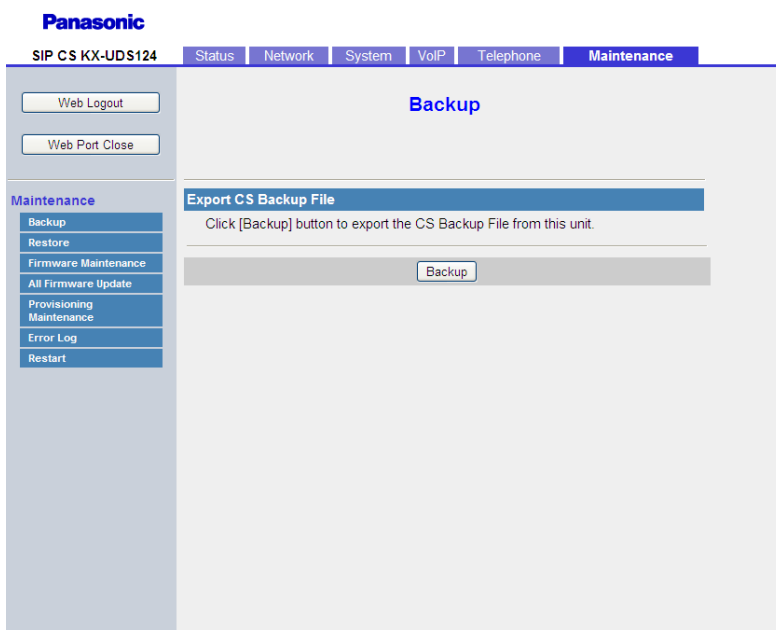

1. Log in to the Super Master CS as the administrator.
2. In the **[Maintenance]** tab, select **[Backup]**.
3. Click **[Backup]** for **[Export CS Backup File]**.
4. On the **[Save As]** window, select a folder to save the backup data to, enter the file name in **[File name]** and click **[Save]**.

Restoring the configuration data

The screenshot shows the Panasonic SIP CS KX-UDS124 web interface. At the top, there are navigation tabs: Status, Network, System, VoIP, Telephone, and Maintenance. The Maintenance tab is selected. On the left side, there is a sidebar menu with options: Web Logout, Web Port Close, and a Maintenance section containing Backup, Restore, Firmware Maintenance, All Firmware Update, Provisioning Maintenance, Error Log, and Restart. The main content area is titled 'Restore' and contains a section for 'Import CS Backup File'. This section has a 'File Name' input field with a 'Browse...' button next to it, and a 'Restore' button below the input field.

1. While the SIP-CS is on, press the RESET switch on the back of the SIP-CS for about 10 seconds. For details, see **9.1 Resetting to Factory Default**.
2. Log in to the Super Master CS as the administrator.
3. In the **[Maintenance]** tab, select **[Restore]**.
4. In **[File Name]**, enter the full path to the file that you want to import, or click **[Browse]** to select the configuration or settings file that you want to restore.
5. Click **[Restore]**.

Note

- If the unit's firmware version changes between backup and restore, the data may not be restored. For details, refer to "Failed (Firmware Version Mismatch)" in **Result Messages** in **2.1.3 Web User Interface Setting List**.
- If the Web settings were changed after the backup file was created, the S-PSs near the restored Super Master CS will function according to older Web settings. To use the most recent settings, log in to the Web user interface for the Super Master CS and reconfigure the settings.

8.1 How to back up and restore configuration data

Section 9

Resetting to Factory Default

This section provides information about the procedure to reset the settings in the SIP-CS to their factory defaults.

9.1 Resetting to Factory Default

This procedure resets all settings in the SIP-CS to their factory defaults.

This type of initialization also deletes all other data on the SIP-CS, such as the call logs and the phonebook.

To perform this initialization, follow the procedure below:

1. Press the RESET switch on the back of the SIP-CS for about 10 seconds.

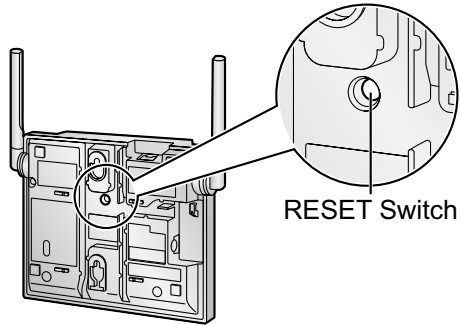

Notice

- After performing this procedure, the SIP-CS will restart automatically. To avoid problems, it is recommended that you save your settings beforehand.

Section 10

Troubleshooting

This section provides information about troubleshooting.

10.1 Troubleshooting

Status indicator

Status	Problem	Cause/Solution
Off	The unit is not receiving power.	The unit is not designed to function when there is a power failure. Make sure that the device supplying PoE is receiving power and that the Ethernet cable is properly connected. If an AC adaptor is connected, confirm that the AC adaptor is connected and receiving power.
Red on	Device error	Consult your dealer.
Red flashing rapidly	<ul style="list-style-type: none"> A network failure occurred during startup. The SIP-CS could not register with the SIP server on startup. 	<ul style="list-style-type: none"> Check network settings. Check that settings are correct for registration to the SIP server.
Red flashing	The SIP-CS is waiting for air synchronization.	<p>If this state continues for a while, check the CS monitor screen in the Web user interface.</p> <ol style="list-style-type: none"> Click the [System] tab, and then click [CS Monitor]. Select [Air Sync Group]. Check the CS monitor screen.
Amber on	An air synchronization error has occurred.	<p>Check the CS monitor screen in the Web user interface.</p> <ol style="list-style-type: none"> Click the [System] tab, and then click [CS Monitor]. Select [Air Sync Group]. Check the CS monitor screen.
Amber flashing	An air synchronization error has occurred (while an S-PS is in use).	<p>Check the CS monitor screen in the Web user interface.</p> <ol style="list-style-type: none"> Click the [System] tab, and then click [CS Monitor]. Select [Air Sync Group]. Check the CS monitor screen.
Amber flashing rapidly	An air synchronization error has occurred and the SIP-CS is in a busy state.	<p>Check the CS monitor screen in the Web user interface.</p> <ol style="list-style-type: none"> Click the [System] tab, and then click [CS Monitor]. Select [Air Sync Group]. Check the CS monitor screen.
Green on	Normal	—
Green flashing	Normal (while an S-PS is in use)	—
Green flashing rapidly	The SIP-CS is in a busy state.	If users frequently experience busy conditions, put an additional cell station near the frequently busy cell station. ^{*1}

*1 When a user makes a call and the cell station is busy, the user sees the message "CS Busy" on the S-PS's display.

Password for Web User Interface Programming

Problem	Cause/Solution
I have lost the login password of the Web user interface for the Administrator or User account.	<ul style="list-style-type: none"> Reset the password from the SIP-CS. The passwords for both Administrator and User will be reset (→ see Section 9 Resetting to Factory Default). For security reasons, it is recommended that the passwords are set again immediately (→ see 2.4.2 Administrator Password).

Time

Problem	Cause/Solution
The time is not correct.	<ul style="list-style-type: none"> In the Web user interface, you can set NTP synchronization and DST (Summer Time) control to adjust the time automatically (→ see 2.4.6 Time Adjust Settings). If the time is still incorrect even after setting NTP synchronization, check the firewall and port forwarding settings on the router.

Checking the Status of the SIP-CS

You can check the status of the SIP-CS by using Web user interface programming (→ see **2.2.2 Network Status** and **2.2.6 PS VoIP Status**) or by looking at system logs (→ see **4.2.3 Syslog Settings**) sent from the SIP-CS.

To check the setting status in the Web user interface

1. Click the **[Status]** tab, and then click **[Network Status]** to check the network settings.
2. Check the status displayed.
3. Click **[PS VoIP Status]** to check the VoIP settings.
4. Click a numbered tab to check the status of the desired S-PS.

To send the system logs of specified events to the syslog server

1. Set the following parameters to specify your PC (Windows operating system, etc.) as the syslog server:
 - **SYSLOG_ADDR**: Specifies the IP address or FQDN of the syslog server.
 - **SYSLOG_PORT**: Specifies the port number of the syslog server.
2. Set the following parameters to log specific events:
 - **SYSLOG_EVENT_SIP**: Logs SIP-related syslog events.
 - **SYSLOG_EVENT_CFG**: Logs syslog events regarding configuration.
 - **SYSLOG_EVENT_VOIP**: Logs syslog events regarding VoIP operation.

Section 11

Appendix

11.1 Open Source Software

Parts of this product use Open Source Software. Relevant conditions apply to this software. Panasonic cannot accept inquiries regarding the content of the following copyright and license information.

<<NetBSD kernel>>

This product uses a part of NetBSD kernel.

The use of a part of NetBSD kernel is based on the typical BSD style license below.

Copyright (c)

The Regents of the University of California. All rights reserved.

Redistribution and use in source and binary forms, with or without modification, are permitted provided that the following conditions are met:

1. Redistributions of source code must retain the above copyright notice, this list of conditions and the following disclaimer.
2. Redistributions in binary form must reproduce the above copyright notice, this list of conditions and the following disclaimer in the documentation and/or other materials provided with the distribution.
3. All advertising materials mentioning features or use of this software must display the following acknowledgement:
This product includes software developed by the University of California, Berkeley and its contributors.
4. Neither the name of the University nor the names of its contributors may be used to endorse or promote products derived from this software without specific prior written permission.

THIS SOFTWARE IS PROVIDED BY THE REGENTS AND CONTRIBUTORS "AS IS" AND ANY EXPRESS OR IMPLIED WARRANTIES, INCLUDING, BUT NOT LIMITED TO, THE IMPLIED WARRANTIES OF MERCHANTABILITY AND FITNESS FOR A PARTICULAR PURPOSE ARE DISCLAIMED. IN NO EVENT SHALL THE REGENTS OR CONTRIBUTORS BE LIABLE FOR ANY DIRECT, INDIRECT, INCIDENTAL, SPECIAL, EXEMPLARY, OR CONSEQUENTIAL DAMAGES (INCLUDING, BUT NOT LIMITED TO, PROCUREMENT OF SUBSTITUTE GOODS OR SERVICES; LOSS OF USE, DATA, OR PROFITS; OR BUSINESS INTERRUPTION) HOWEVER CAUSED AND ON ANY THEORY OF LIABILITY, WHETHER IN CONTRACT, STRICT LIABILITY, OR TORT (INCLUDING NEGLIGENCE OR OTHERWISE) ARISING IN ANY WAY OUT OF THE USE OF THIS SOFTWARE, EVEN IF ADVISED OF THE POSSIBILITY OF SUCH DAMAGE.

However, parts of the NetBSD Kernel are provided with the following copyright notices.

- Copyright (c) 1980, 1983, 1988, 1993 The Regents of the University of California. All rights reserved.
- Copyright (c) 1980, 1986, 1989, 1993 The Regents of the University of California. All rights reserved.
- Copyright (c) 1980, 1986, 1991, 1993 The Regents of the University of California. All rights reserved.
- Copyright (c) 1980, 1986, 1993 The Regents of the University of California. All rights reserved.
- Copyright (c) 1982, 1985, 1986, 1988, 1993, 1994 The Regents of the University of California. All rights reserved.
- Copyright (c) 1982, 1986, 1988, 1990, 1993 The Regents of the University of California. All rights reserved.
- Copyright (c) 1982, 1986, 1988, 1990, 1993, 1994, 1995 The Regents of the University of California. All rights reserved.
- Copyright (c) 1982, 1986, 1988, 1990, 1993, 1995 The Regents of the University of California. All rights reserved.
- Copyright (c) 1982, 1986, 1988, 1991, 1993 The Regents of the University of California. All rights reserved.
- Copyright (c) 1982, 1986, 1988, 1993 The Regents of the University of California. All rights reserved.
- Copyright (c) 1982, 1986, 1988, 1993, 1995 The Regents of the University of California. All rights reserved.
- Copyright (c) 1982, 1986, 1989, 1991, 1993 The Regents of the University of California. All rights reserved.
- Copyright (c) 1982, 1986, 1989, 1993 The Regents of the University of California. All rights reserved.
- Copyright (c) 1982, 1986, 1990, 1991, 1993 The Regents of the University of California. All rights reserved.
- Copyright (c) 1982, 1986, 1990, 1993 The Regents of the University of California. All rights reserved.
- Copyright (c) 1982, 1986, 1990, 1993, 1994 The Regents of the University of California. All rights reserved.
- Copyright (c) 1982, 1986, 1991, 1993 The Regents of the University of California. All rights reserved.
- Copyright (c) 1982, 1986, 1991, 1993, 1994 The Regents of the University of California. All rights reserved.
- Copyright (c) 1982, 1986, 1991, 1993, 1995 The Regents of the University of California. All rights reserved.
- Copyright (c) 1982, 1986, 1993 The Regents of the University of California. All rights reserved.
- Copyright (c) 1982, 1986, 1993, 1994 The Regents of the University of California. All rights reserved.
- Copyright (c) 1982, 1986, 1993, 1994, 1995 The Regents of the University of California. All rights reserved.

Copyright (c) 1982, 1986, 1993, 1995 The Regents of the University of California. All rights reserved.
Copyright (c) 1982, 1988, 1991, 1993 The Regents of the University of California. All rights reserved.
Copyright (c) 1983, 1990, 1993 The Regents of the University of California. All rights reserved.
Copyright (c) 1983, 1993 The Regents of the University of California. All rights reserved.
Copyright (c) 1985, 1986, 1993 The Regents of the University of California. All rights reserved.
Copyright (c) 1985, 1986, 1993 The Regents of the University of California. All rights reserved.
Copyright (c) 1986, 1989, 1991, 1993 The Regents of the University of California. All rights reserved.
Copyright (c) 1986, 1993 The Regents of the University of California. All rights reserved.
Copyright (c) 1987, 1991, 1993 The Regents of the University of California. All rights reserved.
Copyright (c) 1987, 1993 The Regents of the University of California. All rights reserved.
Copyright (c) 1987, 1993 The Regents of the University of California. All rights reserved.
Copyright (c) 1988 Regents of the University of California. All rights reserved
Copyright (c) 1988 Stephen Deering.
Copyright (c) 1988 University of Utah.
Copyright (c) 1988, 1989, 1993 The Regents of the University of California. All rights reserved.
Copyright (c) 1988, 1991, 1993 The Regents of the University of California. All rights reserved.
Copyright (c) 1988, 1992, 1993 The Regents of the University of California. All rights reserved.
Copyright (c) 1988, 1993 The Regents of the University of California. All rights reserved.
Copyright (c) 1989 The Regents of the University of California. All rights reserved.
Copyright (c) 1989, 1991, 1993 The Regents of the University of California. All rights reserved.
Copyright (c) 1989, 1993 The Regents of the University of California. All rights reserved.
Copyright (c) 1989, 1993, 1994 The Regents of the University of California. All rights reserved.
Copyright (c) 1990, 1991, 1993 The Regents of the University of California. All rights reserved.
Copyright (c) 1990, 1993 The Regents of the University of California. All rights reserved.
Copyright (c) 1991, 1993 The Regents of the University of California. All rights reserved.
Copyright (c) 1991, 1993, 1994 The Regents of the University of California. All rights reserved.
Copyright (c) 1992 Regents of the University of California. All rights reserved.
Copyright (c) 1992, 1993 The Regents of the University of California. All rights reserved.
Copyright (c) 1993 The Regents of the University of California. All rights reserved.
Copyright (c) 1993 Adam Glass
Copyright (C) 1993 by Sun Microsystems, Inc. All rights reserved.
Copyright (c) 1994 Gordon W. Ross
Copyright (c) 1994 Winning Strategies, Inc. All rights reserved.
Copyright (c) 1995 The Regents of the University of California. All rights reserved.
Copyright (C) 1995, 1996, 1997, and 1998 WIDE Project. All rights reserved.
Copyright (c) 1996 The Regents of the University of California. All rights reserved.
Copyright (c) 1996 John S. Dyson All rights reserved.
Copyright (c) 1996 Matt Thomas. All rights reserved.
Copyright (c) 1996 Matthew R. Green. All rights reserved.
Copyright (c) 1996 Paul Kranenburg
Copyright (c) 1996, 1997, 1999, 2001 The NetBSD Foundation, Inc. All rights reserved.
Copyright (c) 1996, 2000 Christopher G. Demetriou. All rights reserved.
Copyright (c) 1996,1999 by Internet Software Consortium.
Copyright (c) 1996-1999 by Internet Software Consortium.
Copyright (c) 1997 Jonathan Stone and Jason R. Thorpe. All rights reserved.
Copyright (c) 1997 Christos Zoulas. All rights reserved.
Copyright (c) 1997 Manuel Bouyer. All rights reserved.
Copyright (c) 1997, 1998 The NetBSD Foundation, Inc. All rights reserved.
Copyright (c) 1997, 1998, 1999, 2000 The NetBSD Foundation, Inc. All rights reserved.
Copyright (c) 1997, 1998, 1999, 2001 The NetBSD Foundation, Inc. All rights reserved.
Copyright (c) 1997, 1998, 1999, 2002 The NetBSD Foundation, Inc. All rights reserved.
Copyright (c) 1997, 1998, 2000, 2001 The NetBSD Foundation, Inc. All rights reserved.
Copyright (c) 1997, 1998, 2001 The NetBSD Foundation, Inc. All rights reserved.
Copyright (c) 1997,98 The NetBSD Foundation, Inc. All rights reserved.
Copyright (C) 1997-2000 Sony Computer Science Laboratories Inc. All rights reserved.
Copyright (c) 1997-2002 The NetBSD Foundation, Inc. All rights reserved.
Copyright (c) 1998 The NetBSD Foundation, Inc. All rights reserved.
Copyright (c) 1998 Todd C. Miller <Todd.Miller@courtesan.com> All rights reserved.
Copyright (c) 1998, 1999 The NetBSD Foundation, Inc. All rights reserved.
Copyright (c) 1998, 1999, 2000 The NetBSD Foundation, Inc. All rights reserved.
Copyright (c) 1998, 1999, 2000, 2001 The NetBSD Foundation, Inc. All rights reserved.
Copyright (c) 1998, 2000 The NetBSD Foundation, Inc. All rights reserved.
Copyright (c) 1998, 2000, 2001 The NetBSD Foundation, Inc. All rights reserved.
Copyright (c) 1999 The NetBSD Foundation, Inc. All rights reserved.
Copyright (C) 1999 WIDE Project. All rights reserved.

11.1 Open Source Software

Copyright (c) 1999, 2000 Jason L. Wright (jason@thought.net) All rights reserved.
Copyright (c) 1999, 2000 The NetBSD Foundation, Inc. All rights reserved.
Copyright (c) 1999, 2000, 2001 The NetBSD Foundation, Inc. All rights reserved.
Copyright (c) 1999, 2001 The NetBSD Foundation, Inc. All rights reserved.
Copyright (c) 2000 The NetBSD Foundation, Inc. All rights reserved.
Copyright (c) 2000, 2001 The NetBSD Foundation, Inc. All rights reserved.
Copyright (c) 2000, 2001, 2002 The NetBSD Foundation, Inc. All rights reserved.
Copyright (c) 2001 The NetBSD Foundation, Inc. All rights reserved.
Copyright (c) 2002 The NetBSD Foundation, Inc. All rights reserved.
Copyright 1998 Massachusetts Institute of Technology. All rights reserved.
Copyright 2001 Wasabi Systems, Inc. All rights reserved.
Portions Copyright (c) 1993 by Digital Equipment Corporation.
Portions Copyright (c) 1995 by International Business Machines, Inc.
Copyright (c) 1983, 1989 The Regents of the University of California. All rights reserved.
Copyright (c) 1996 by Internet Software Consortium. All rights reserved.
Copyright (c) 1980, 1986, 1989 Regents of the University of California. All rights reserved.
Copyright (c) 1988 The Regents of the University of California. All rights reserved.
Copyright (c) 1992, 1993 The Regents of the University of California. All rights reserved.
Copyright (c) 1994 Christopher G. Demetriou. All rights reserved.
Copyright (c) 1997 The NetBSD Foundation, Inc. All rights reserved.
Copyright (c) 1999 The NetBSD Foundation, Inc. All rights reserved.
Copyright (c) 2001 The NetBSD Foundation, Inc. All rights reserved.
Copyright (c) 1996 Gardner Buchanan <gbuchanan@shl.com> All rights reserved.

Parts of the NetBSD Kernel are provided with the licenses that are slightly different from the above Berkeley-formed license. Please refer the source code of the NetBSD Kernel about the details. The source code of the NetBSD Kernel is provided by the NetBSD CVS Repositories (<http://cvsweb.netbsd.org/bsdweb.cgi/>), and this product includes parts of the source code in the following directories.

<http://cvsweb.netbsd.org/bsdweb.cgi/src/sys/kern/>
<http://cvsweb.netbsd.org/bsdweb.cgi/src/sys/net/>
<http://cvsweb.netbsd.org/bsdweb.cgi/src/sys/netinet/>

<<MD5>>

This software uses the Source Code of RSA Data Security, Inc. described in the RFC1321 (MD5 Message-Digest Algorithm).

Copyright (C) 1991-2, RSA Data Security, Inc. Created 1991. All rights reserved.

License to copy and use this software is granted provided that it is identified as the "RSA Data Security, Inc. MD5 Message-Digest Algorithm" in all material mentioning or referencing this software or this function.

License is also granted to make and use derivative works provided that such works are identified as "derived from the RSA Data Security, Inc. MD5 Message-Digest Algorithm" in all material mentioning or referencing the derived work.

RSA Data Security, Inc. makes no representations concerning either the merchantability of this software or the suitability of this software for any particular purpose. It is provided "as is" without express or implied warranty of any kind.

These notices must be retained in any copies of any part of this documentation and/or software.

<<MT19937>>

The MT19937 software that Takuji Nishimura and Makoto Matsumoto developed is contained, and this product shall be used subject to the following license conditions.

Copyright (C) 1997 - 2002, Makoto Matsumoto and Takuji Nishimura, All rights reserved.

Redistribution and use in source and binary forms, with or without modification, are permitted provided that the following conditions are met:

1. Redistributions of source code must retain the above copyright notice, this list of conditions and the following disclaimer.
2. Redistributions in binary form must reproduce the above copyright notice, this list of conditions and the following disclaimer in the documentation and/or other materials provided with the distribution.
3. The names of its contributors may not be used to endorse or promote products derived from this software without specific prior written permission.

THIS SOFTWARE IS PROVIDED BY THE COPYRIGHT HOLDERS AND CONTRIBUTORS "AS IS" AND ANY EXPRESS OR IMPLIED WARRANTIES, INCLUDING, BUT NOT LIMITED TO, THE IMPLIED WARRANTIES OF MERCHANTABILITY AND FITNESS FOR A PARTICULAR PURPOSE ARE DISCLAIMED. IN NO EVENT SHALL THE COPYRIGHT OWNER OR CONTRIBUTORS BE LIABLE FOR ANY DIRECT, INDIRECT, INCIDENTAL, SPECIAL, EXEMPLARY, OR CONSEQUENTIAL DAMAGES (INCLUDING, BUT NOT LIMITED TO, PROCUREMENT OF SUBSTITUTE GOODS OR SERVICES; LOSS OF USE, DATA, OR PROFITS; OR BUSINESS INTERRUPTION) HOWEVER CAUSED AND ON ANY THEORY OF LIABILITY, WHETHER IN CONTRACT, STRICT LIABILITY, OR TORT (INCLUDING NEGLIGENCE OR OTHERWISE) ARISING IN ANY WAY OUT OF THE USE OF THIS SOFTWARE, EVEN IF ADVISED OF THE POSSIBILITY OF SUCH DAMAGE.

<<thttpd>>

The thttpd software that ACME Labs developed is contained, and this product shall be used subject to the following license conditions.

Copyright 1995,1998,1999,2000 by Jef Poskanzer <jef@acme.com>. All rights reserved.

Redistribution and use in source and binary forms, with or without modification, are permitted provided that the following conditions are met:

1. Redistributions of source code must retain the above copyright notice, this list of conditions and the following disclaimer.
2. Redistributions in binary form must reproduce the above copyright notice, this list of conditions and the following disclaimer in the documentation and/or other materials provided with the distribution.

THIS SOFTWARE IS PROVIDED BY THE AUTHOR AND CONTRIBUTORS "AS IS" AND ANY EXPRESS OR IMPLIED WARRANTIES, INCLUDING, BUT NOT LIMITED TO, THE IMPLIED WARRANTIES OF MERCHANTABILITY AND FITNESS FOR A PARTICULAR PURPOSE ARE DISCLAIMED. IN NO EVENT SHALL THE AUTHOR OR CONTRIBUTORS BE LIABLE FOR ANY DIRECT, INDIRECT, INCIDENTAL, SPECIAL, EXEMPLARY, OR CONSEQUENTIAL DAMAGES (INCLUDING, BUT NOT LIMITED TO, PROCUREMENT OF SUBSTITUTE GOODS OR SERVICES; LOSS OF USE, DATA, OR PROFITS; OR BUSINESS INTERRUPTION) HOWEVER CAUSED AND ON ANY THEORY OF LIABILITY, WHETHER IN CONTRACT, STRICT LIABILITY, OR TORT (INCLUDING NEGLIGENCE OR OTHERWISE) ARISING IN ANY WAY OUT OF THE USE OF THIS SOFTWARE, EVEN IF ADVISED OF THE POSSIBILITY OF SUCH DAMAGE.

Index

A

Access Levels (IDs and Passwords) 22
Administrator Password, setting 72, 167

B

Backup, setting 138

C

Characters Available for String Values 167
Configuration File Programming 165
CS Management 83
CS Monitor 88

D

Dial Plan 258

E

Enable LLDP 65
Encryption 158
Error Log 145
Export Phonebook 136, 252

F

Firmware Update 140, 265
Firmware Update, setting 139, 174
Flexible Button Settings 125, 209, 262
Flexible Button Settings, Copy & Paste 127, 263

H

How to backup and restore configurations 271

I

Import Phonebook 133, 252
Import Phonebook - PS 134
IP Phone (Priority) 66
IP Phone (VLAN ID) 66

L

LLDP Settings 65
LLDP-MED Interval timer 65

M

Maintenance Settings 137

N

Network Settings 61, 186

O

Open Source Software 282

P

Provisioning 147, 152
Provisioning, setting 142, 176

PS Registration 91, 241

R

Recommended Environment 22
Resetting to Factory Default 275
Restart 145
Restore, setting 138
Result Messages 46

S

SIP Settings 95, 221
Status Settings 50
System Settings 71, 167

T

Telephone Settings 111, 194
Terminology 3
Tone Settings 129, 197
Tree Survey, setting 86
Troubleshooting 277

V

VoIP Settings 94, 210

W

Web User Interface Programming 21
Web User Interface Setting List 25
Web User Interface Window 44

Notes

Panasonic System Networks Co., Ltd.

1-62, 4-chome, Minoshima, Hakata-ku, Fukuoka 812-8531, Japan

Copyright:

This material is copyrighted by Panasonic System Networks Co., Ltd., and may be reproduced for internal use only. All other reproduction, in whole or in part, is prohibited without the written consent of Panasonic System Networks Co., Ltd.

© Panasonic System Networks Co., Ltd. 2012