

# **Polycom® KIRK ServiceTool 4.20**

---

## **User Guide**

**14184605, version 2**

Copyright © Polycom, Inc.  
All Rights Reserved

Catalog No. 14184605  
Version 2

### **Proprietary and Confidential**

The information contained herein is the sole intellectual property of Polycom, Inc. No distribution, reproduction or unauthorized use of these materials is permitted without the expressed written consent of Polycom, Inc. Information contained herein is subject to change without notice and does not represent commitment of any type on the part of Polycom, Inc. Polycom and Accord are registered trademarks of Polycom, Inc.

### **Notice**

While reasonable effort was made to ensure that the information in this document was complete and accurate at the time of printing, Polycom, Inc., cannot assume responsibility for any errors. Changes and/or corrections to the information contained in this document may be incorporated into future issues.

---

# Table of Contents

<b>Introduction</b> .....	<b>vii</b>
---------------------------	------------

## **1 Hardware**

Repeater and Base Station Programming Hardware .....	1-1
Handset Adjustment Hardware .....	1-2
KIRK 3040 Adjustment Hardware .....	1-2
KIRK 40XX Handset Adjustment Hardware .....	1-3

## **2 KIRK Repeater and Base Station Programming**

ServiceTool Program .....	2-1
Repeater Programming of the KWS300 and the KWS500 .....	2-4
Repeater Programming of the KWS600v3 and the KWS6000 .....	2-7
Repeater Programming of the KWS600v3, Single Cell .....	2-8
Repeater Programming of the KWS600v3, Multi Cell and the KWS6000 .....	2-12
Repeater Programming of the KWS1500 and KWS8000 .....	2-15
Repeater Programming of the KWS1500 and KWS8000 .....	2-15
Alternative Synchronization Ways .....	2-19
Repeater Jump .....	2-21
Repeater Jump - KWS600v3 Multi Cell, KWS1500, KWS8000 and KWS6000 .....	2-21
Numbering of Repeaters in Jump (Chain) KWS1500 and KWS8000 .....	2-21
Numbering of Repeaters in Jump (Chain) KWS300, KWS500 and KWS600v3 Single Cell .....	2-22
KIRK Base Station Programming of the KWS1500 and KWS8000 .....	2-23
KIRK Base Station Programming of the KWS1500 and KWS8000, 1.8/1.9GHz (RFP5) .....	2-24

## **3 Handset Adjustments**

Startup Text PP .....	3-1
Gain Control: Internal Loudspeaker and Microphone .....	3-3
Gain Control: Handsfree Loudspeaker and Microphone .....	3-4

## **4 KIRK Software Load**

KIRK Load Flash .....	4-1
Load Flash KIRK 3040 Handset .....	4-2
KIRK 3040 Handset (Hardware Edition Lower Than PCS20) .....	4-2
KIRK 3040 Handset (Hardware Edition PCS 20 and Above) .....	4-3
Load Flash KIRK 40xx Handset .....	4-4
Load Flash KWS500 .....	4-4

Default Commands ..... 4-5  
KIRK Load Menu ..... 4-5

## 5 Serial Number of the KIRK Handset

Identify Handset IPEI No. on the Handset Display ..... 5-1

## 6 Warnings

Repeater Numbering Warnings ..... 6-1  
Load Menu Warnings ..... 6-1  
Hot Spot Warnings ..... 6-1  
Repeater Type Warnings ..... 6-2

## 7 Replacement of Logo and Icon

Adding Personal Logo and Icon to the ServiceTool Program ..... 7-1  
Installation ..... 7-1

## 8 Language

Translation into Another Language ..... 8-1

## 9 Latest Version of the ServiceTool Help File

ServiceTool Program Version 4.19 ..... 9-1  
Replacement of the ServiceTool Help File ..... 9-1  
Installation ..... 9-1  
Use of Help File Version 4.19 in Older Versions of the ServiceTool Program ..... 9-2  
Facilities Implemented and Bugs Corrected ..... 9-2  
    ServiceTool Program Version 4.19 ..... 9-2  
    ServiceTool Program Version 4.18 ..... 9-2  
    ServiceTool Program Version 4.17 ..... 9-3  
    ServiceTool Program Version 4.16 ..... 9-3  
    ServiceTool Program Version 4.15 ..... 9-3  
    ServiceTool Program Version 4.14 ..... 9-3  
    ServiceTool Program Version 4.13 ..... 9-3  
    ServiceTool Program Version 4.12 ..... 9-3  
    ServiceTool Program Version 4.11 ..... 9-3  
    ServiceTool Program Version 4.10 ..... 9-4  
    ServiceTool Program Version 4.9 ..... 9-4  
    ServiceTool Program Version 4.8 ..... 9-4  
    ServiceTool Program Version 4.7 ..... 9-4

---

ServiceTool Program Version 4.6 .....	9-4
---------------------------------------	-----



---

# Introduction

With the ServiceTool software it is possible to program the KIRK Repeater to connect to the KIRK DECT Radio Infrastructure solutions such as the KWS300, the KWS500, the KWS600v3, the KWS1500, the KWS8000 and the KWS6000. Furthermore, it is possible to adjust the volume of the KIRK Handsets with the ServiceTool as well as to load software to different units.

In the following, the content of this ServiceTool user guide will be introduced:

**1 “Hardware”** on page 1-1

This section gives information about the hardware to be used for the repeater programming and for the handset adjustment (KIRK 3040 and KIRK 40XX)

**2 “KIRK Repeater and Base Station Programming”** on page 2-1

In this section the following will be introduced:

*“ServiceTool Program”* on page 2-1: This section introduces the start page of the ServiceTool program as well as the Communication page, and it sets the guidelines for the Comport Settings.

*“Repeater Programming of the KWS300 and the KWS500”* on page 2-4: In this section you will find information on how to configure the repeater to the KWS300 and the KWS500 solution.

*“Repeater Programming of the KWS600v3 and the KWS6000”* on page 2-7: In this section you will find information on how to configure the repeater to the KWS600v3 in a single cell or a multi cell solution and to the KWS6000.

*“Repeater Programming of the KWS1500 and KWS8000”* on page 2-15: In this section you will find information on how to configure the repeater to the KWS1500 1.8GHz or KWS8000 1.8GHz solution.

*“Alternative Synchronization Ways”* on page 2-19: This section describes how to establish alternative synchronisation ways.

*“Repeater Jump”* on page 2-21: This section describes how to establish repeater jumps.

“KIRK Base Station Programming of the KWS1500 and KWS8000” on page 2-23: In this section you will find information on how to configure the Base Station the KWS1500 and KWS8000 solution.

**3 “Handset Adjustments” on page 3-1**

In this section the following will be introduced:

“Startup Text PP” on page 3-1: This section introduces the ServiceTool page for the adjustment of the KIRK handsets.

“Gain Control: Internal Loudspeaker and Microphone” on page 3-3: This section introduces the ServiceTool page for the adjustment of the internal loudspeaker and microphone of the KIRK handsets.

“Gain Control: Handsfree Loudspeaker and Microphone” on page 3-4: This section introduces the ServiceTool page for the adjustment of the handsfree loudspeaker and the handsfree microphone of the KIRK handsets.

**4 “KIRK Software Load” on page 4-1**

“KIRK Load Flash” on page 4-1: This section describes how to load Flash (in case of upgrading) or Menu (e.g. when changing language) to the KIRK Handsets or Flash to other units.

“Load Flash KIRK 3040 Handset” on page 4-2: In this section you will find information on how to load Flash for the KIRK 3040 Handset.

“Load Flash KIRK 40xx Handset” on page 4-4: In this section you will find information on how to load Flash for the KIRK 40XX Handsets.

“Load Flash KWS500” on page 4-4: In this section you will find information on how to load Flash for the KWS500 solution 1.8GHz in case of upgrading.

“Default Commands” on page 4-5: In this section you will find information on how to be able to select the type of unit which has to be set up to factory default settings.

“KIRK Load Menu” on page 4-5: This section describes how to load Menu to the KIRK Handsets.

**5 “Serial Number of the KIRK Handset” on page 5-1:** In this section you will learn how to identify the serial number of a KIRK Handset using the ServiceTool program.

**6 “Warnings” on page 6-1:** In this section, the warnings of this user guide are listed.

**7 “Replacement of Logo and Icon” on page 7-1:**  
In this section you can learn how to change the logo and icon of the ServiceTool program.

**8 “Language” on page 8-1:**  
This section describes how to change the language in the ServiceTool program.



- 9 [“Latest Version of the ServiceTool Help File”](#) on page 9-1:  
In this section, you will be introduced to the ServiceTool version of this help file as well as the changes made to the ServiceTool in the past.



---

# Hardware

In order to use the ServiceTool software, special hardware is required. This section gives information about the hardware to be used for the repeater programming (“[Repeater and Base Station Programming Hardware](#)” on page 1-1) and for the handset adjustment (KIRK 3040 and KIRK 40xx) (“[Handset Adjustment Hardware](#)” on page 1-2).

## Repeater and Base Station Programming Hardware

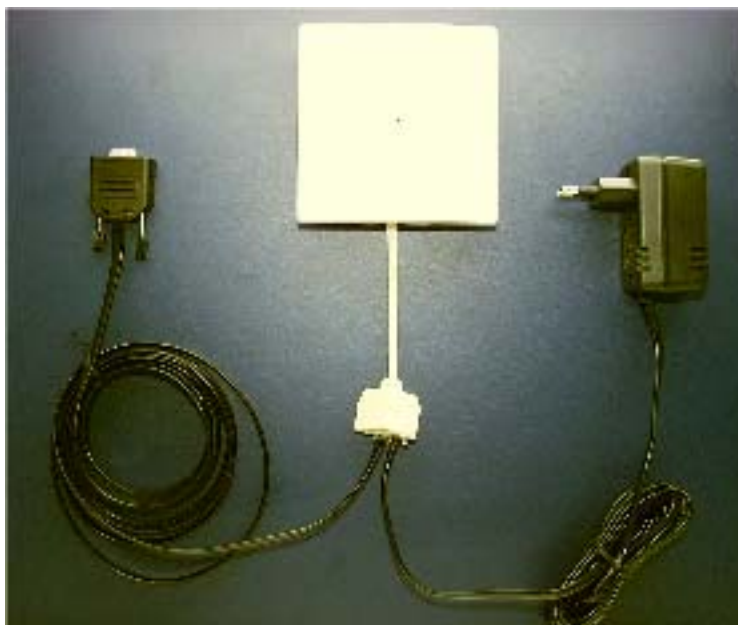
To be able to program a KIRK Repeater and a KIRK Base Station, a Repeater and Base Station Programming Kit is required. The table below shows the three items of this hardware package.

*Table 1-1 Repeater and Base Station Programming Kit*

<b>Repeater Programming Kit, Part No.: 0231 9508</b>
Serial cable
Modular connector adapter for the repeaters
Modular connector adapter for the base stations

Furthermore, a power supply is needed. For the repeater the power supply is similar to the one normally used for the repeater. The base station will be powered from the computer.

Connect the modular connector adapter to the repeater or the base station and the serial cable to the comport of your computer.

**Figure 1-1** Hardware Configuration: Repeater and Base Station Programming Kit

## Handset Adjustment Hardware

To be able to adjust a KIRK Handset, different cable kits for the KIRK 3040 Handset (“KIRK 3040 Adjustment Hardware” on page 1-2) and for the KIRK 40XX Handset (“KIRK 40XX Handset Adjustment Hardware” on page 1-3) are required.

### KIRK 3040 Adjustment Hardware

A Serio Interface is required for the adjustment or load of software to the KIRK 3040 Handset. The table below gives an overview of the three items of this hardware package.

**Table 1-2** Serio Interface KIRK 3040 Handset

<b>Serio Interface, Part No.: 0231 9509</b>
Serial cable
Special charger giving access to the handset
Power Supply

Connect the serial cable to the charger and to the comport of your computer.

## KIRK 40XX Handset Adjustment Hardware

A Cable Kit is required for the adjustment or load of software to the KIRK 40xx Handsets. The table below gives an overview of the two items of this hardware package.

*Table 1-3 Cable Kit KIRK 40xx Handset*

<b>Cable Kit KIRK40xx Handset, Part No.: 0231 9542</b>
Serial cable
Adapter

Connect the serial cable via the adapter to the standard charger and to the comport of your computer.

---

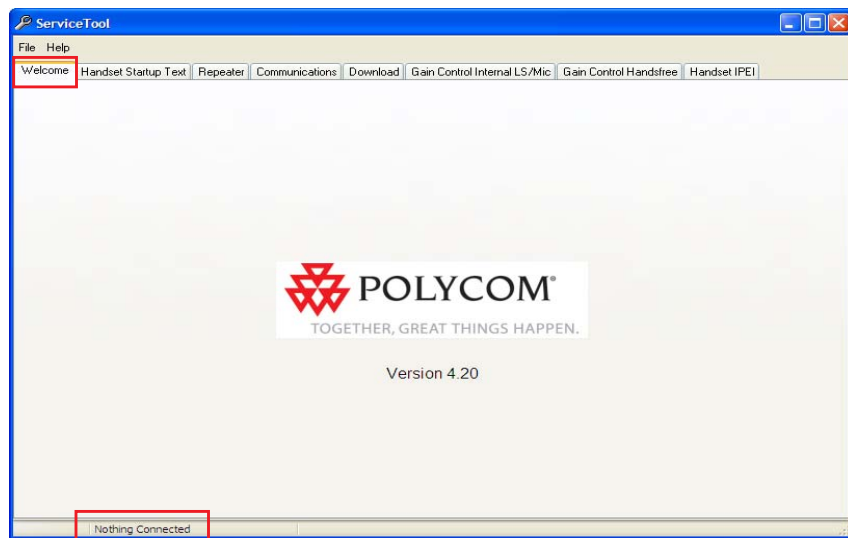
# KIRK Repeater and Base Station Programming

This section provides you with an introduction of the ServiceTool program ("[ServiceTool Program](#)" on page 2-1), and it gives information on how to configure the KIRK Repeaters and Base Stations to the KIRK DECT Radio Infrastructure Solutions ("[Repeater Programming of the KWS300 and the KWS500](#)" on page 2-4, "[Repeater Programming of the KWS600v3 and the KWS6000](#)" on page 2-7, "[Repeater Programming of the KWS1500 and KWS8000](#)" on page 2-15, "[KIRK Base Station Programming of the KWS1500 and KWS8000](#)" on page 2-23). Furthermore, you will find a description of how to establish alternative synchronisation ways ("[Repeater Jump](#)" on page 2-21) as well as repeater jumps ("[KIRK Base Station Programming of the KWS1500 and KWS8000](#)" on page 2-23)

## ServiceTool Program

In the following, you will be introduced to the ServiceTool program, and you will learn how to set the comport and connect to the KIRK Repeater or Handset. This is necessary in order to be able to program these units.

When activating the ServiceTool program, the following window appears:

**Figure 2-1** Main Window of the ServiceTool Program

The main window of the ServiceTool program consists of a **Welcome** page, and no actions can be performed in this window.

When clicking at **Help** in the menu bar, the ServiceTool helpfile will appear

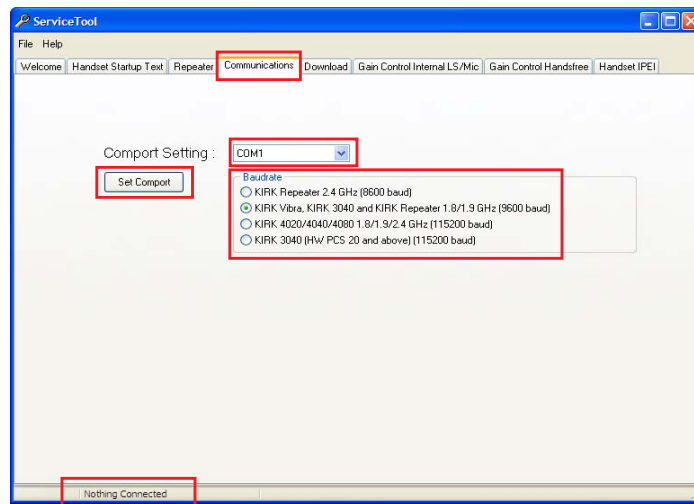
At the bottom of the window in the Status Bar, it is possible to see the type of the connected unit and to see the used comport. If nothing is connected this will also appear from the Status Bar.

When starting up the ServiceTool program nothing is connected.

- 1 Click the **Communications** page in order to carry out the communication with the repeater or the handset.

The following window appears:

**Figure 2-2** Communications page of the ServiceTool Program



With the Communications page you set up and initialise the Comport.

- 2 Select the comport to be activated.
- 3 Enable the box related to the unit to connect to.
- 4 Activate the button Set Comport

New information will appear at the bottom of the window.

In the above figure, Com is selected and Repeater or PP Connected

The below table displays the baudrate settings of the different KIRK hardware.

**Table 2-1** Baudrate Settings

Baudrate Settings	KIRK Hardware
8600 Baud	Repeater 2.4GHz programming
9600 Baud	Vibra II (PP2) - PP-3040 handset 1.8GHz (PP3) (hardware lower than PCS 20). PP-3040 2.4GHz (PP4) and 1.8GHz and 1.9GHz Repeater Programming
115200 Baud	4020/4040/4080 1.8GHz, 1.8GHz and 2.4GHz
115200 Baud	3040 (hardware PCS 20 and above)

When the comport has been selected and activated, and the repeater or the handset has been connected, it is possible to start the repeater programming.

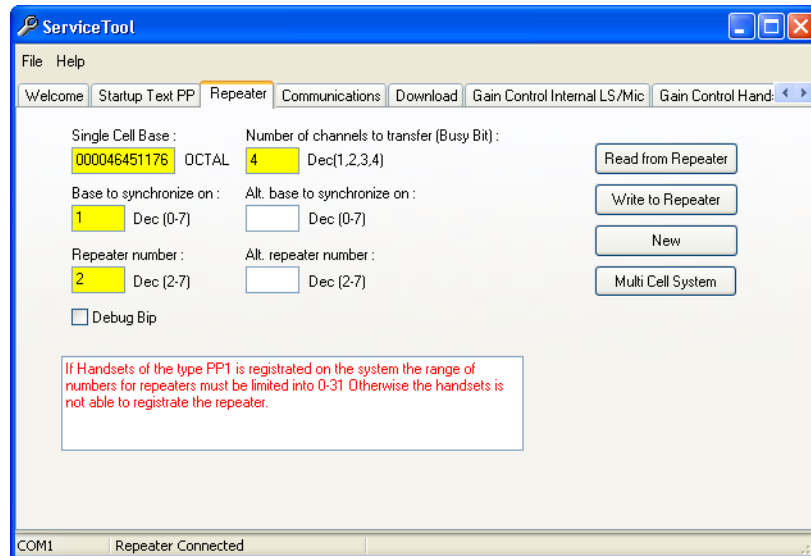


## Repeater Programming of the KWS300 and the KWS500

In this section you will find information on how to configure the repeater to the KWS300 solution and the KWS500 solution.

- Click the Repeater tab, and the following page appears:

**Figure 2-3** Repeater Page of the ServiceTool Program



In the following table you will find information about each field of the Repeater page as well as information about the actions to carry out.

**Table 2-2** Data Fields of the Repeater page of the KWS500

Data Fields	Description	Action
Single Cell Base	The ARI number of the base station must be registered in this field in order to connect to a base station.	Enter the ARI number of the Base Station (see the label on the rear of the Base Station or use the CCFP Adm. Program (only for KWS300 and KWS500)).
Base station to synchronize on	The number of base stations the repeater must synchronize on. The number is default set to 1.	Enter the number of base stations.
Repeater number	The number assigned to the repeater. The assigned number of the repeater must be between 2 and 7. <b>Warning:</b> It is not allowed to assign a number to the repeater similar to another repeater in a situation where a common overlap is present between the actual units. If this happens, handover between the different units is not possible.	Enter a number between 2 and 7
Debug Bip	The debug bip can be set for the handset to bip when it logs on to the repeater. When connected to the repeater and when the handset is off-hook, it is possible to hear a bip every 3 seconds. This function can be used during error tracking on the system. If operation is normal, it is recommended to disable the debug bip	Consider if the Debug Bip is to be activated or not.

**Table 2-2** Data Fields of the Repeater page of the KWS500

Data Fields	Description	Action
Number of channels to transfer (Busy Bit)	<p>When setting the busy bit, it is possible to control, when the repeater will transmit a busy signal to the handsets:</p> <ol style="list-style-type: none"> <li>1. Busy bit transmitted when one handset is off-hook</li> <li>2. Busy bit transmitted when two handsets are off-hook.</li> <li>3. Busy bit transmitted when three handsets are off-hook.</li> <li>4. Busy bit transmitted when four handsets are off-hook.</li> </ol> <p><b>Old Repeater Version:</b>  Busy bit is from the manufacturer set to default 2, i.e. there is one channel left for making handover. It is recommended to use the default setting (2). The default setting of 2 indicates that the repeater can support 2 handsets simultaneously - off hook - and there is still one channel available for communication between the repeater and the base station and one channel available for handover events.</p> <p><b>Full Slot Repeater - 4ch connected to KWS300 or to KWS500</b>  Even if the Busy Bit is set to 4, handover between repeater and base station is possible in a situation where 4 handsets are off hook. This is possible, as the KWS500 provides 6 RF channels and the KWS300 provides 12 RF channels. Therefore channels are available for handover events.</p> <p><b>Busy indication</b>  A busy (occupied) repeater can be determined by a handset locked to the repeater in on hook. As soon as a repeater is busy, the antenna symbol in the handset display flashes meaning that an off hook cannot be established.</p>	Set the busy bit in order to receive a busy signal to the handsets.
Alt. base to synchronize on	Please go to <a href="#">"Repeater Jump"</a> on page 2-21 for more information	
Alt repeater number	Please go to <a href="#">"Repeater Jump"</a> on page 2-21 for more information	

**Table 2-2** Data Fields of the Repeater page of the KWS500

Data Fields	Description	Action
Read from Repeater	With this function, it is possible to see the actual programming of the repeater. The information will appear in the data fields.	Click this button if you want to verify the actual programming of the repeater.
Write to Repeater	The entered values are programmed into the repeater. The software verifies the validity of the entered values, and a warning will appear, if any illegal value is entered. <b>Note:</b> If a field is yellow, the value has not been loaded into the repeater. When clicking the button Write to Repeater the colour of the fields will change into white indicating the transfer of the values to the repeater.	When the values have been entered in the data fields, click this button.
New	When clicking this button, the information entered in the data fields will be deleted.	Click this button if you want to delete the entered values.
Multi Cell System	When clicking this button, the page will change into a configuration page for a multi cell solution.	Click this button if you want to configure a multi cell solution.

**Warning:** If two repeaters are connected to two different base stations or to the same base station, a distance of 25 metres must be established between the repeaters. In that way, Hot Spot situations will not occur. Hot Spot situations can result in lost calls or they can make off hook impossible.

## Repeater Programming of the KWS600v3 and the KWS6000

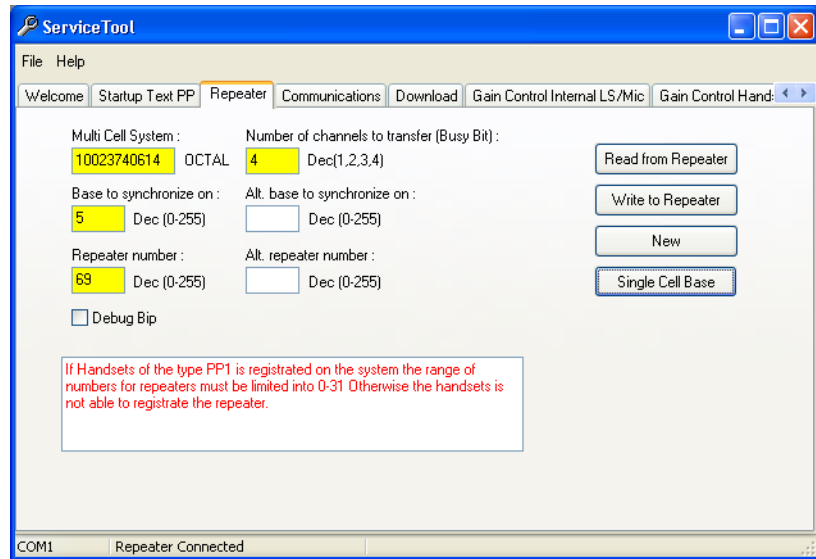
In this section you will find information on how to configure the repeater to the KWS600v3 or a KWS6000 solution ([“Repeater Programming of the KWS600v3, Multi Cell and the KWS6000”](#) on page 2-12) . The KWS600v3 can be set up as a Single Cell ([“Repeater Programming of the KWS600v3, Single Cell”](#) on page 2-8) or a Multi Cell solution ([“Repeater Programming of the KWS600v3, Multi Cell and the KWS6000”](#) on page 2-12).

**Note:** The type of repeater used for the KWS600v3 must be the 4ch (full slot) repeater. The 2ch (single slot) repeater must not be used for the KWS600v3.

## Repeater Programming of the KWS600v3, Single Cell

- Click the Repeater tab, and the following page appears:

Figure 2-4 Repeater Page of the Service Tool Program



When configuring the KWS600v3 as a single cell solution, the page Single Cell Base must be used.

**Table 2-3** Data Fields of the Repeater Page of the KWS600v3, Single Cell

Data Fields	Description	Action
Single Cell Base	The ARI number of the base station must be registered in this field in order to connect to a base station.	Enter the ARI number of the Base Station (see the label on the rear of the KWS600v3)
Base to synchronize on	The number of base stations the repeater must synchronize on. In a KWS600v3, the number is default set to 1.	Enter the number of base stations.
Repeater number	<p>The number assigned to the repeater. In a KWS600v3 solution the assigned number of the repeater must be between 2 and 7.</p> <p><b>Warning:</b> It is not allowed to assign a number to the repeater similar to another repeater in a situation where a common overlap is present between the actual units. If this happens, handover between the different units is not possible.</p>	Enter a number between 2 and 7
Debug Bip	The debug bip can be set for the handset to bip when it logs on to the repeater. When connected to the repeater and when the handset is off-hook, it is possible to hear a bip every 3 seconds. This function can be used during error tracking on the system. If operation is normal, it is recommended to disable the debug bip	Consider if the Debug Bip is to be activated or not.

**Table 2-3** Data Fields of the Repeater Page of the KWS600v3, Single Cell

Data Fields	Description	Action
Number of channels to transfer (Busy Bit)	<p>When setting the busy bit, it is possible to control, when the repeater will transmit a busy signal to the handsets:</p> <ol style="list-style-type: none"> <li>1. Busy bit transmitted when one handset is off-hook</li> <li>2. Busy bit transmitted when two handsets are off-hook.</li> <li>3. Busy bit transmitted when three handsets are off-hook.</li> <li>4. Busy bit transmitted when four handsets are off-hook.</li> </ol> <p>Even if the Busy Bit is set to 4, handover between repeater and the KWS600v3 is possible in a situation where four handsets are off hook. This is possible as the KWS600v3 provides 12 channels, and therefore channels are available for handover events.</p> <p><b>Busy indication</b> A busy (occupied) repeater can be determined by a handset locked to the repeater in on hook. As soon as a repeater is busy, the antenna symbol in the handset display flashes meaning that an off hook cannot be established.</p>	Set the busy bit in order to receive a busy signal to the handsets.
Alt. base to synchronize on	Please go to <a href="#">"Repeater Jump"</a> on page 2-21 for more information	
Alt repeater number	Please go to <a href="#">"Repeater Jump"</a> on page 2-21 for more information	
Read from Repeater	With this function, it is possible to see the actual programming of the repeater. The information will appear in the data fields.	Click this button if you want to verify the actual programming of the repeater.

**Table 2-3** Data Fields of the Repeater Page of the KWS600v3, Single Cell

Data Fields	Description	Action
Write to Repeater	<p>The entered values are programmed into the repeater. The software verifies the validity of the entered values, and a warning will appear, if any illegal value is entered.</p> <p><b>Note:</b> If a field is yellow, the value has not been loaded into the repeater. When clicking the button Write to Repeater the colour of the fields will change into white indicating the transfer of the values to the repeater.</p>	When the values have been entered in the data fields, click this button.
New	When clicking this button, the information entered in the data fields will be deleted.	Click this button if you want to delete the entered values.
Multi Cell System	When clicking this button, the page will change into a configuration page for a multi cell solution.	Click this button if you want to configure a multi cell solution.

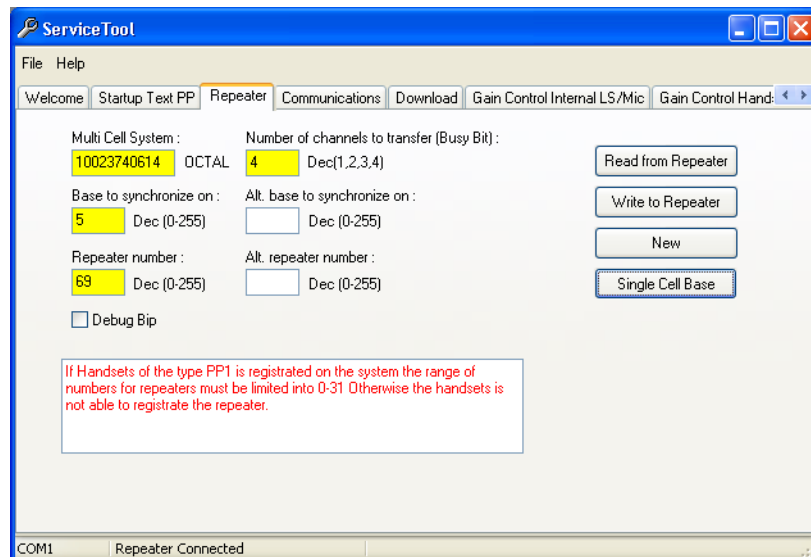


**Warning: If two repeaters are connected to two different base stations or to the same base station, a distance of 25 metres must be established between the repeaters. In that way, Hot Spot situations will not occur. Hot Spot situations can result in lost calls or they can make off hook impossible.**

## Repeater Programming of the KWS600v3, Multi Cell and the KWS6000

- Click the Repeater tab, and the following page appears:

*Figure 2-5 Repeater Page of the Service Tool Program*



When configuring the KWS600v3 as a multi cell solution or the KWS6000, the page Multi Cell System must be used.

**Table 2-4** Data Fields of the Repeater Page of the KWS600v3, Multi Cell

Data Fields	Description	Action
Multi Cell System	The ARI number must be registered in this field in order to connect to this unit.	Enter the ARI number of the KWS (see the label on the rear of the KWS)
Base to synchronize on	The number of base stations the repeater must synchronize on.	Enter the number of base stations.
Repeater number	<p>The number assigned to the repeater. The number of the repeater is the number of the KWS600v3 or the KWS6000+ 64. Example: repeater connected to server no. 07. <math>07+64 = 71</math>. In the KWS600v3 multi cell solution or the KWS6000, the assigned number must be between 0 and 255</p> <p><b>Warning:</b> It is not allowed to assign a number to the repeater similar to another repeater in a situation where a common overlap is present between the actual units. If this happens, handover between the different units is not possible.</p>	Enter a number between 0 and 255 (no. of KWS600v3 or KWS6000+ 64)
Debug Bip	The debug bip can be set for the handset to bip when it logs on to the repeater. When connected to the repeater and when the handset is off-hook, it is possible to hear a bip every 3 seconds. This function can be used during error tracking on the system. If operation is normal, it is recommended to disable the debug bip	Consider if the Debug Bip is to be activated or not.

**Table 2-4** Data Fields of the Repeater Page of the KWS600v3, Multi Cell

Data Fields	Description	Action
Number of channels to transfer (Busy Bit)	<p>When setting the busy bit, it is possible to control, when the repeater will transmit a busy signal to the handsets:</p> <ol style="list-style-type: none"> <li>1. Busy bit transmitted when one handset is off-hook</li> <li>2. Busy bit transmitted when two handsets are off-hook.</li> <li>3. Busy bit transmitted when three handsets are off-hook.</li> <li>4. Busy bit transmitted when four handsets are off-hook.</li> </ol> <p>Even if the Busy Bit is set to 4, handover between repeater and the KWS600v3 is possible in a situation where four handsets are off hook. This is possible as the KWS600v3 provides 11 channels, and therefore channels are available for handover events.</p> <p><b>Busy indication</b> A busy (occupied) repeater can be determined by a handset locked to the repeater in on hook. As soon as a repeater is busy, the antenna symbol in the handset display flashes meaning that an off hook cannot be established.</p>	Set the busy bit in order to receive a busy signal to the handsets.
Alt. base to synchronize on	Please go to <a href="#">"Repeater Jump"</a> on page 2-21 for more information	
Alt. repeater number	Please go to <a href="#">"Repeater Jump"</a> on page 2-21 for more information	
Read from Repeater	With this function, it is possible to see the actual programming of the repeater. The information will appear in the data fields.	Click this button if you want to verify the actual programming of the repeater.

**Table 2-4** Data Fields of the Repeater Page of the KWS600v3, Multi Cell

Data Fields	Description	Action
Write to Repeater	The entered values are programmed into the repeater. The software verifies the validity of the entered values, and a warning will appear, if any illegal value is entered.  <b>Note:</b> If a field is yellow, the value has not been loaded into the repeater. When clicking the button Write to Repeater the colour of the fields will change into white indicating the transfer of the values to the repeater.	When the values have been entered in the data fields, click this button.
New	When clicking this button, the information entered in the data fields will be deleted.	Click this button if you want to delete the entered values.
Single Cell Base	When clicking this button, the page will change into a configuration page for a single cell solution.	Click this button if you want to configure a multi cell solution.

**Warning: If two repeaters are connected to two different base stations or to the same base station, a distance of 25 metres must be established between the repeaters. In that way, Hot Spot situations will not occur. Hot Spot situations can result in lost calls or they can make off hook impossible.**

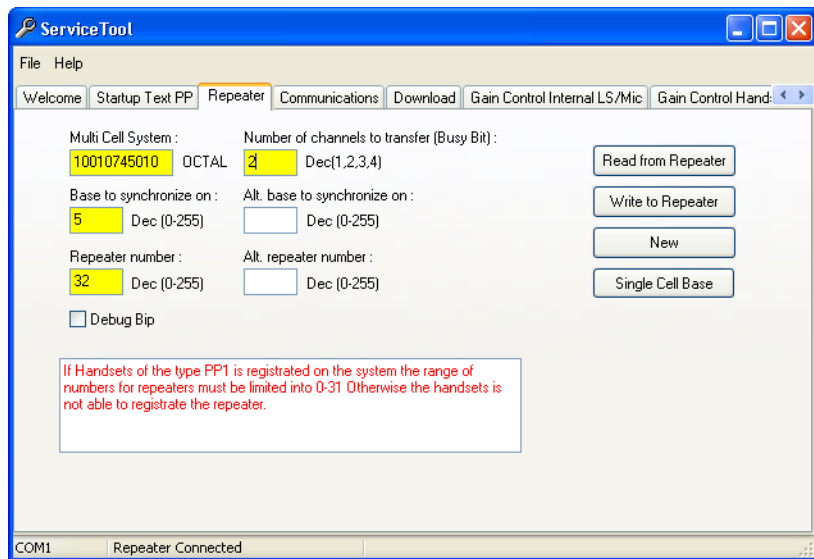
## Repeater Programming of the KWS1500 and KWS8000

In this section you will find information on how to configure the repeater to the KWS1500 and KWS8000 solution ( “Repeater Programming of the KWS1500 and KWS8000” on page 2-15).

### Repeater Programming of the KWS1500 and KWS8000

Click the Repeater tab, and the following page appears:

Figure 2-6 Repeater Page of the ServiceTool Program



When configuring the KWS1500 or the KWS8000, the page Multi Cell System must be used.

**Table 2-5** Data Fields of the KWS1500 and KWS8000

Data Fields	Description	Action
Multi Cell System	The ARI number of the KWS1500 or KWS8000 must be registered in this field in order to connect to this unit.	Enter the ARI number of the Base Station (see the label on the rear of the KWS1500 or KWS8000 or use the CCFP Adm. Program). <b>Note:</b> If the mother board has been replaced, the number written on the label is not equal to the actual number loaded to the server.
Base to synchronize on	The number of base stations the repeater must synchronize on.	Enter the number of base stations.
Repeater number	The number assigned to the repeater. The number of the repeater must be between 0 and 255. If PP1's are subscribed to the system, the number must be between 0-31. If the number is higher, the PP1 cannot connect to the repeater. <b>Warning:</b> It is not allowed to assign a number to the repeater similar to another repeater in a situation where a common overlap is present between the actual units. If this happens, handover between the different units is not possible.	Enter a number between 0 and 255 (0-31 if PP1 is subscribed to the system).
Debug Bip	The debug bip can be set for the handset to bip when it logs on to the repeater. When connected to the repeater and when the handset is off-hook, it is possible to hear a bip every 3 seconds. This function can be used during error tracking on the system. If operation is normal, it is recommended to disable the debug bip	Consider if the Debug Bip is to be activated or not.

**Table 2-5** Data Fields of the KWS1500 and KWS8000

Data Fields	Description	Action
Number of channels to transfer (Busy Bit)	<p>When setting the busy bit, it is possible to control, when the repeater will transmit a busy signal to the handsets:</p> <ol style="list-style-type: none"> <li>1. Busy bit transmitted when one handset is off-hook</li> <li>2. Busy bit transmitted when two handsets are off-hook.</li> <li>3. Busy bit transmitted when three handsets are off-hook.</li> <li>4. Busy bit transmitted when four handsets are off-hook (only for full slot repeaters)</li> </ol> <p><b>Old Repeater Version:</b>  Busy bit is from the manufacturer set to default 2, i.e. there is one channel left for making handover. It is recommended to use the default setting (2). The default setting of 2 indicates that the repeater can support 2 handsets simultaneously - off hook - and there is still one channel available for communication between the repeater and the base station and one channel available for handover events.</p> <p><b>Full Slot Repeater - 4ch connected to KWS1500 or KWS8000</b>  Busy bit is from the manufacturer set to default 4, and it is recommended to use the setting 3. This setting indicates that the repeater can support three handsets simultaneously - off hook - and still there is one channel available for the handover events. If handover is not required the busy bit can be set to 4.</p> <p><b>Busy indication</b>  A busy (occupied) repeater can be determined by a handset locked to the repeater in on hook. As soon as a repeater is busy, the antenna symbol in the handset display flashes meaning that an off hook cannot be established.</p>	Set the busy bit in order to receive a busy signal to the handsets.
Alt. base to synchronize on	Please go to <a href="#">"Repeater Jump"</a> on page 2-21 for more information	
Alt. repeater number	Please go to <a href="#">"Repeater Jump"</a> on page 2-21 for more information	

**Table 2-5** Data Fields of the KWS1500 and KWS8000

Data Fields	Description	Action
Read from Repeater	With this function, it is possible to see the actual programming of the repeater. The information will appear in the data fields.	Click this button if you want to verify the actual programming of the repeater.
Write to Repeater	The entered values are programmed into the repeater. The software verifies the validity of the entered values, and a warning will appear, if any illegal value is entered. <b>Note:</b> If a field is yellow, the value has not been loaded into the repeater. When clicking the button Write to Repeater the colour of the fields will change into white indicating the transfer of the values to the repeater.	When the values have been entered in the data fields, click this button.
New	When clicking this button, the information entered in the data fields will be deleted.	Click this button if you want to delete the entered values.
Single Cell Base	When clicking this button, the page will change into a configuration page for a single cell solution.	Click this button if you want to configure a multi cell solution.

**Warning: If two repeaters are connected to two different base stations or to the same base station, a distance of 25 metres must be established between the repeaters. In that way, Hot Spot situations will not occur. Hot Spot situations can result in lost calls or they can make off hook impossible.**

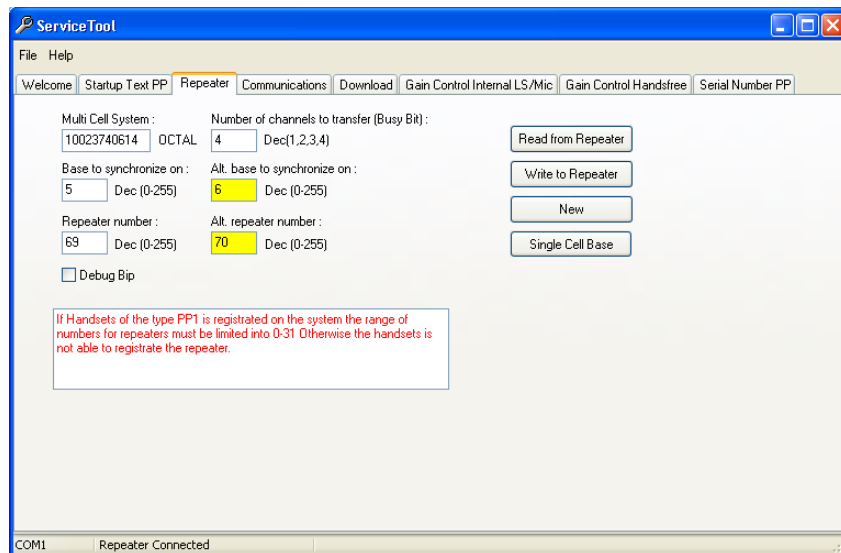
## Alternative Synchronization Ways

The ServiceTool program is able to determine whether or not an actual repeater manages the Alternative Synchronization ways. In this section you will find information on how to establish Alternative Synchronization Ways.

Click the Repeater tab, and the following page appears:



Figure 2-7 Repeater Page of the ServiceTool Program



If Alternative Synchronization Ways are possible, the data fields for entering data related to Alternative Synchronization ways will appear.

The repeater is able to change the base station to which it is synchronizing as the primary base station (appears in the data field Base to synchronize on ). The criteria for changing the base station to synchronize on (in the data field Alt base to synchronize on ) is that the signal from the primary base station to synchronize on must disappear totally, e.g. in case of a break down, no signal transmitted.

As soon as the signal from the primary base station in the field Base to synchronize on returns, the repeater will change its synchronization back to the primary base station.

If the communication is active on the repeater, the repeater will not change back to the primary base station, before the active call is ended. In that way, a conversation will not be interrupted as a result of changing synchronization ways.

Table 2-6 Data Fields of the Alternative Synchronization Ways

Data Fields	Description	Action
Alt. base to synchronize on	The number of the base station the repeater must synchronize on in case of a break down of the primary base station.	Enter the number of the synchronization base station.
Alt. repeater number	The number to assign to the repeater	Enter the number assigned to the repeater.

## Repeater Jump

This section describes how to make repeater jump.

### Repeater Jump - KWS600v3 Multi Cell, KWS1500, KWS8000 and KWS6000

Several conditions have to be present, and therefore the indications mentioned below must be followed.

**Note:** Only the units mentioned in the below table can be used to make repeater jump:

*Table 2-7 Units Available for Repeater Jump*

Units Available for Repeater Jump	
Base stations	Part no. 0233 31xx (new design)
Repeaters	Part no. 0233 33xx (new design). Other part nos. might be used, however generally speaking the repeater must be of the new design.
Handsets	KIRK 3040, hardware 9 or higher, software PCS 3F or higher

Other KIRK handsets such as the PP1, the Vibra II, KIRK 3020 and KIRK 3040 (small flash) cannot be used in a repeater jump situation, as handover is not possible.

The PP1 cannot handle base station numbers higher than 31, and it cannot handle handover inside the chain of repeaters in a repeater jump configuration.

The Vibra II cannot handle handover inside the repeater chain in a repeater jump configuration.

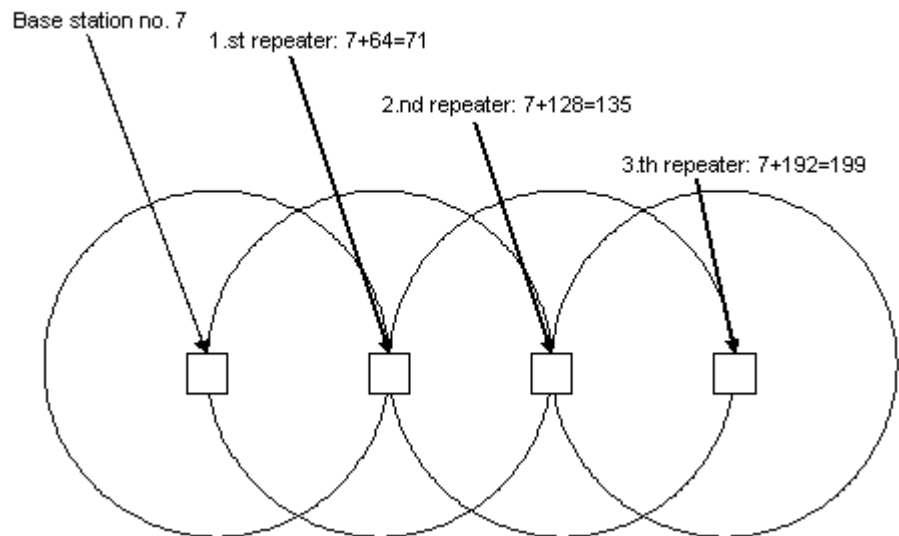
The KIRK 3040 handset small flash (hardware version PCS 8 or lower and software version PCS2(x)) cannot handle handover inside a repeater chain in a repeater jump configuration.

### Numbering of Repeaters in Jump (Chain) KWS1500 and KWS8000

In the table below, it will be explained how to number the repeaters in a jump.

**Table 2-8** Repeater Numbers in a Jump

Repeater Number	Base Station Number
1st. repeater in a chain	Base station no. + 64 The base station to synchronize on: Number of base station
2nd. repeater in a chain	Base station no. + 128 The base station to synchronize on: number of previous repeater
3rd. repeater in a chain	Base station no + 192 The base station to synchronize on: Number of previous repeater.

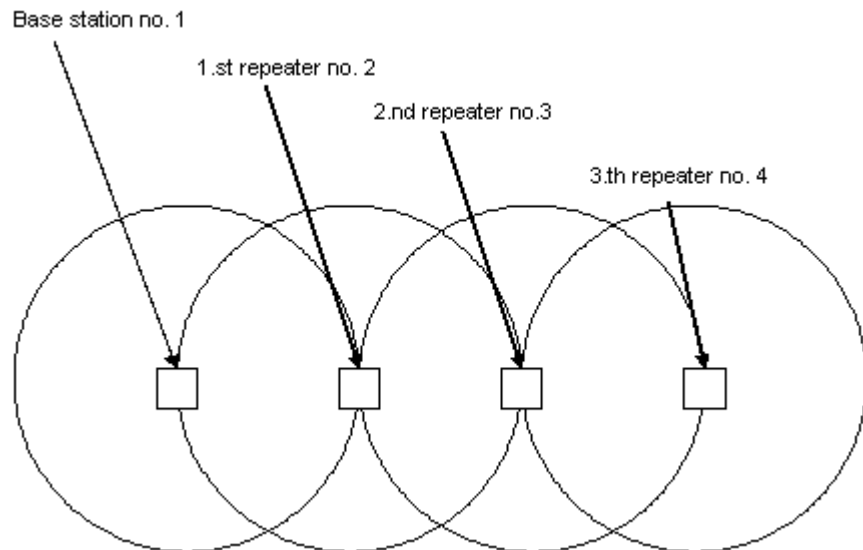
**Figure 2-8** Repeater Numbers in a Jump

## Numbering of Repeaters in Jump (Chain) KWS300, KWS500 and KWS600v3 Single Cell

In the table below, it will be explained how to number the repeaters in a jump.

**Table 2-9** Repeater Numbers in a Jump

Repeater Number	Base Station Number
1st. repeater in a chain	No. 2 The base station to synchronize on: Number of base station (1)
2nd. repeater in a chain	No. 3 The base station to synchronize on: number of previous repeater
3rd. repeater in a chain	No. 4 The base station to synchronize on: Number of previous repeater.

**Figure 2-9** Repeater Numbers in a Jump

## KIRK Base Station Programming of the KWS1500 and KWS8000

In this section you will find information on how to configure the base station to the KWS1500 and KWS8000, 1.8/1.9GHz (RFP5) solution ( “KIRK Base Station Programming of the KWS1500 and KWS8000, 1.8/1.9GHz (RFP5)” on page 2-24).

## KIRK Base Station Programming of the KWS1500 and KWS8000, 1.8/1.9GHz (RFP5)

**Warning: Connecting the Base Station with the computer using the serial cable when the computer is powered from the grid and/or connected with cables to LAN can damage your computer's serial port due to different potentials.**

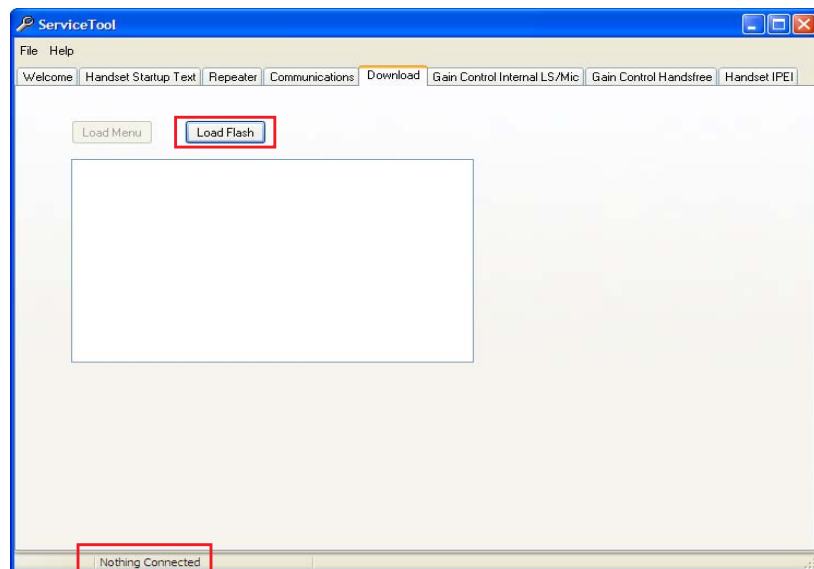
**It is highly recommended that before connecting the Base Station to your computer using the serial cable, your computer is not connected with cables to LAN or connected to an external power source. The computer can be connected to the wireless LAN and can be powered from the battery.**

**The Base Station's LED must be turned off through the entire programming process. Otherwise, restart the programming procedure.**

First, you must plug the splitter into the Base Station and connect the serial cable to your computer and to the splitter. The Base Station's LED is OFF. Start the Service Tool Program.

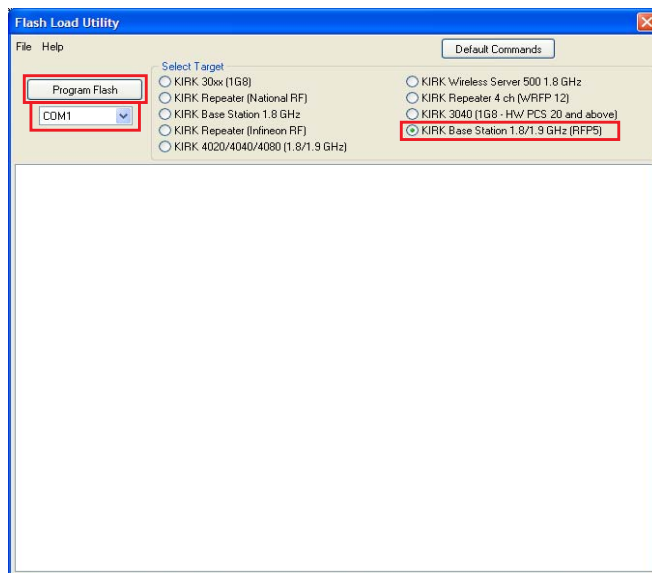
Click the Download tab, and the following page appears:

*Figure 2-10 Download Page of the ServiceTool Program*



Click the Load Flash button, and the following page appears:

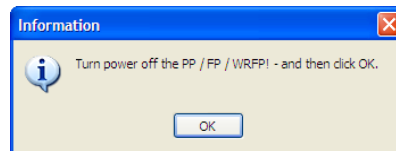
**Figure 2-11** Download - Load Flash Page of the ServiceTool Program



Make sure you select the proper COM port for programming the Base Station and the KIRK Base Station **1.8/1.9 GHz (RFP5)** option.

Click the Program Flash button, and the following warning appears:

**Figure 2-12** Turn Power Off warning of the ServiceTool Program

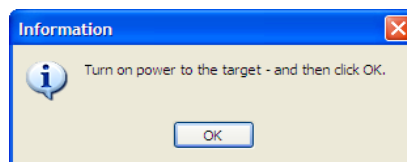


Make sure that the power/communication cable from the KWS1500 or KWS8000 is unplugged from the splitter.

Click the OK button, and the open file dialog appears.

Select the proper file, press the Open button and the following warning appears:

**Figure 2-13** Turn on power warning of the ServiceTool Program



Plug the power/communication cable from the KWS 1500 or KWS8000 into the Base Station splitter.

**Warning:** The LED of the Base Station must be OFF. If the LED starts flashing when connecting the line from the KWS1500 or KWS8000, the pins did not connect correctly. Please unplug and try again.

When the line has been successfully connected without the LED turning on, the Base station is in boot mode. Press OK on the PC tool and the software will start to download.

In the Load Flash window you can see the progress of the operation.

The Base Station is now updated with the new software. Remove the serial cable and the splitter from the Base Station and connect the cable from the KWS1500 or KWS8000 to the Base Station.

---

# Handset Adjustments

In this section the ServiceTool program page for the adjustment of the KIRK Handsets will be introduced (“[Startup Text PP](#)” on page 3-1).

Furthermore, this section provides information about the ServiceTool program page for the adjustment of the internal loudspeaker and microphone of the KIRK Handsets (“[Gain Control: Internal Loudspeaker and Microphone](#)” on page 3-3).

Finally, you will also find information about the ServiceTool page for the adjustment of the handsfree loudspeaker and the handsfree microphone of the KIRK Handsets (“[Gain Control: Handsfree Loudspeaker and Microphone](#)” on page 3-4)

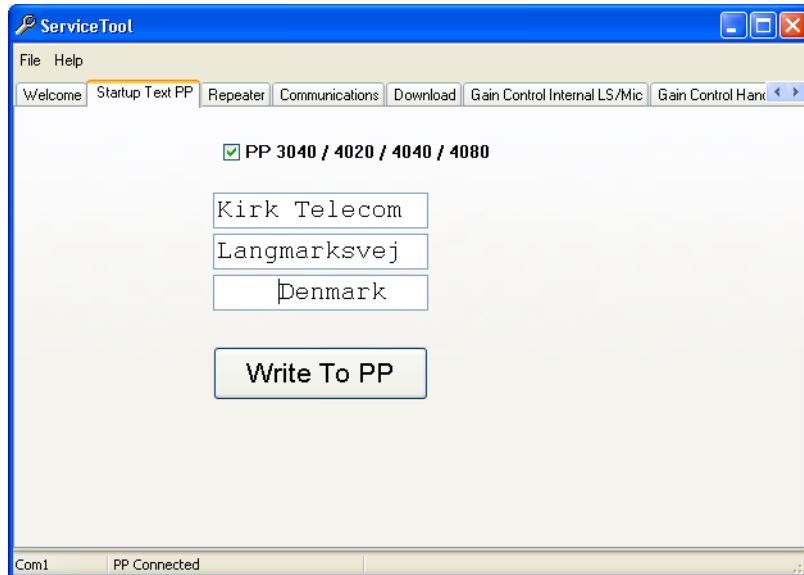
## Startup Text PP

This section introduces the ServiceTool page for the adjustment of the KIRK Handsets.



- Click the Startup Text PP tab, and the following window appears:

**Figure 3-1** ServiceTool Startup Text PP Page



**Table 3-1** Data Fields of the Startup Text PP Page

Data Fields	Description	Action
PP 3040/4020/ 4040/4080	Use the check box to set the type of the KIRK Handset.	Enable the check box
Display Text	The text entered in this field will replace the original standby text as delivered.  The length of the text field has to be set to match the display of the KIRK Handset:  KIRK 3040/KIRK 40XX: 12 characters per line and 3 lines in total.  KIRK PP1/PP: 10 characters per line, and only 1 line.	Enter a text in the field and press the button Write to PP

Turn OFF/ON the KIRK handset and the new start up text will appear in the display.

Regarding the KIRK 3040 and the KIRK 40XX Handsets it is possible to change the start up text through the keyboard as well. This is described in the following steps:

**1** \*\*\*\*

- 2 MUTE (<)
- 3 Enter the new text (12 characters per line and 2 lines)
- 4 MUTE ( )

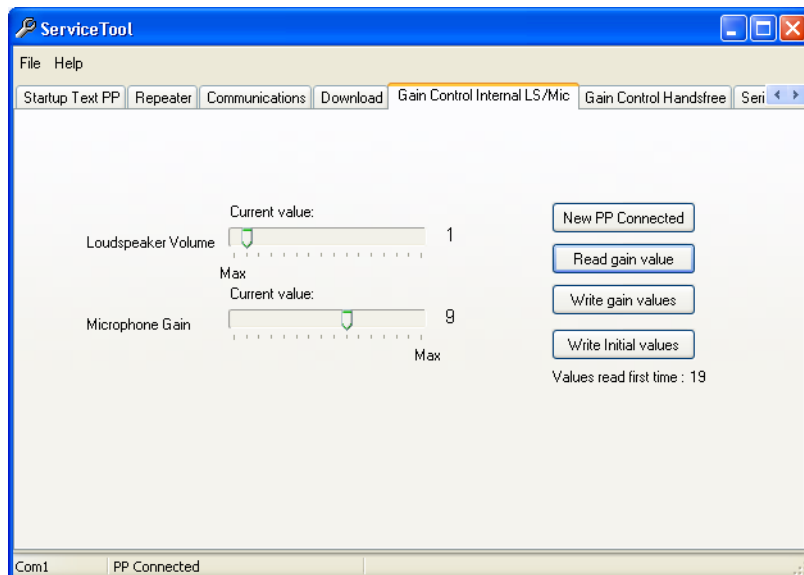
(The above information can be found in the KIRK Handset user guides).

## Gain Control: Internal Loudspeaker and Microphone

This section introduces the ServiceTool page for the adjustment of the internal loudspeaker and microphone of the KIRK Handsets.

- 1 Click the Gain Control Internal LS Mic tab, and the following window appears

*Figure 3-2 ServiceTool Gain Control Internal LS/Mic Page*



- 2 Press the **Read gain value** button. The actual settings will appear via the position of the slide bars in the left of the window. This value is also stored as initial value (values read the first time). In the window above, the setting is 5 for Loudspeaker Volume and 7 for Microphone Gain. The settings will differ from handset to handset due to tolerances of components.

**Note:** Max. loudspeaker volume = Slide bar placed to the left.  
Max. Microphone gain = Slide bar placed to the right.

- 3 Move the slide bars to change the settings.

One step up or down equals +/- 2 dB for microphone and +/- 1 dB for loudspeaker.

- 4 Press the **Write gain values** button, and the new settings are transferred to the handset. If you want to return to the initial values, press the **Write Initial Values** button.

**Note:** The initial value will disappear when clicking the **New PP Connected** button.

- 5 Press the **New PP Connected** button to reset initial value when a new PP is connected.

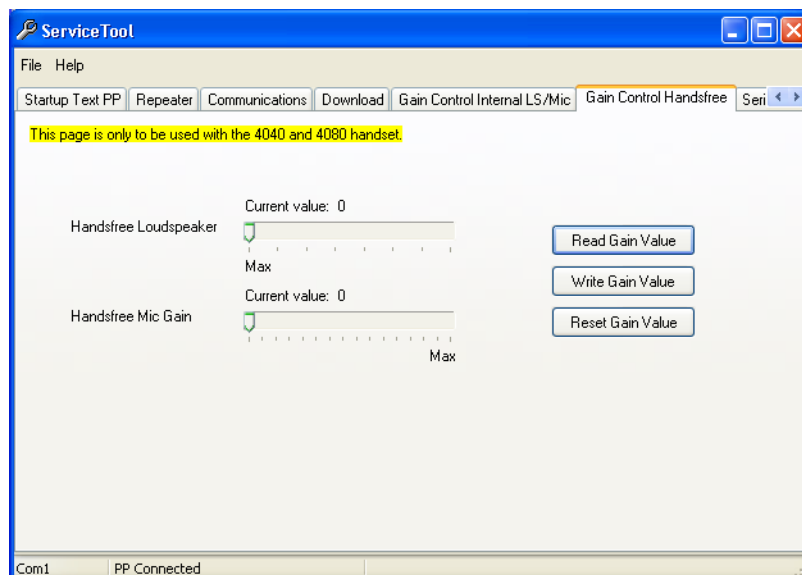
## Gain Control: Handsfree Loudspeaker and Microphone

In this section, you will find information on how to adjust the handsfree loudspeaker and the handsfree microphone of the KIRK Handsets using the ServiceTool program.

**Note:** This function is only available for the KIRK 4040/4080 Handset.

Click the **Gain Control Handsfree** button, and the following window appears:

**Figure 3-3** ServiceTool Gain Control Handsfree Page



- 1 Press the **Read Gain Value** button. The actual settings will appear via the position of the slide bars in the left of the window. In the window above the setting is 6 for Handsfree Loudspeaker volume and C for Handsfree Mic Gain.

**Note:** Max loudspeaker volume = slide bar placed to the left.  
Max. microphone gain = slide bar placed to the right.

- 2 Move the slide bars to change the settings.

- 3 Press the **Write Gain Value** button, and the new settings are transferred to the handset. If you want to return to the initial values, press the **Write Initial Values** button

---

# KIRK Software Load

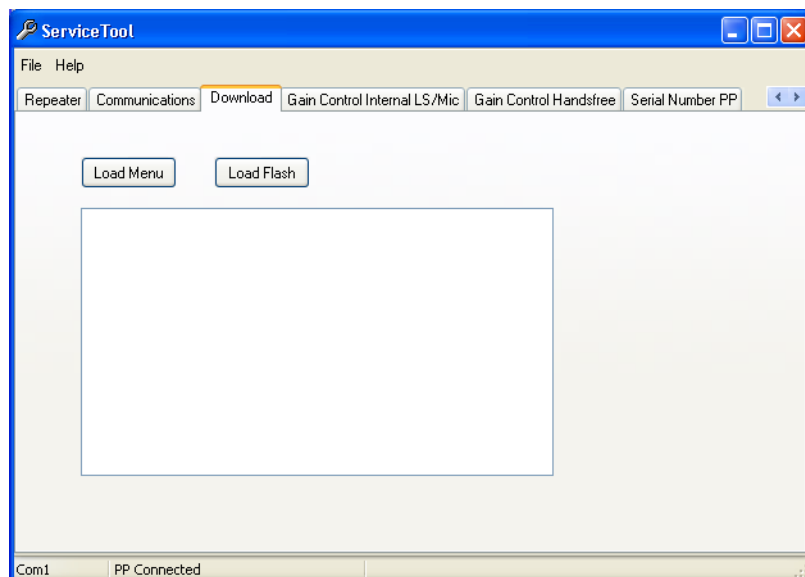
This section describes how to load Flash (in case of upgrading) (“KIRK Load Flash” on page 4-1) or Menu (in case of a new menu, e.g. when adding a new language to the menu) to the KIRK Handsets (“KIRK Load Menu” on page 4-5). “Default Commands” on page 4-5.

## KIRK Load Flash

In this section, you will find information about how to load Flash if a new software version has to be uploaded to the KIRK Handset.

- 1 Click the Download tab, and the following window appears:

*Figure 4-1 ServiceTool Download page*



- 2 Click the Load Flash button to upload a new software version to the KIRK Handset or a KIRK unit. The following window appears:

**Figure 4-2** ServiceTool Flash Load Utility Page



- 3 Select the comport in the data field to the left.
- 4 Select the target in the Select Target list. In this list you choose between the KIRK products to be loaded. In the following, the load flash of the KIRK 3040 Handset will be described (“Load Flash KIRK 3040 Handset” on page 4-2) as well as load flash of the KIRK 40xx Handset (“Load Flash KIRK 40xx Handset” on page 4-4) and the KWS500 (“Load Flash KWS500” on page 4-4).

## Load Flash KIRK 3040 Handset

This section describes how to load flash to the KIRK 3040 Handset (hardware edition lower than PCS 20 = KIRK Handsets 30xx (1.8GHz) / Repeater National on page 4-2) and the KIRK 3040 Handset (hardware edition PCS20 and above = 3040 (1.8GHz), HW PCS 20 and above on page 4-3).

### KIRK 3040 Handset (Hardware Edition Lower Than PCS20)

Please follow the steps below in order to load flash to the KIRK 3040 Handset (hardware edition lower than PCS 20 = KIRK Handsets 30xx (1.8GHz) / Repeater National):

- 1 Press the Program Flash button, and follow the instructions you receive from the program.
- 2 Turn off the KIRK Handset when you receive the message Turn off PP.
- 3 Press the button for powering up the handset and keep it pressed when you receive the message Turn on power to target and press any key. The handset is not supposed to power up. If this happens, clean the contacts at the bottom of the handset.
- 4 Press any key on the PC keyboard. Wait until the message Boot code downloaded appears. Now, you can release the button on the handset for powering up.
- 5 Wait until the text Successful upgrade appears. The software has now been transferred to the handset. The version of the software can be identified by pressing \*99982\* Mute ( ).

**Error Message**

If an error occurs during upload of the software, and the message `Upload of software failed` it might not be possible to power up the handset afterwards. If it is not possible to turn on the handset, please go through the following steps:

- 1 Remove the battery of the handset.
- 2 Insert the battery again.
- 3 Repeat the above steps (1 - 5) for Program Flash.

**KIRK 3040 Handset (Hardware Edition PCS 20 and Above)**

Please follow the steps below in order to load flash to the KIRK 3040 Handset (hardware edition PCS20 and above = 3040 (1.8GHz, HW PCS 20 and above)

- 1 Press the Program Flash button, and follow the instructions you receive from the program.
- 2 Turn off the KIRK Handset when you receive the message `Turn off PP`.
- 3 Press the button for powering up the handset and keep it pressed when you receive the message `Turn on power to target`. The handset is not supposed to power up. If this happens, clean the contacts at the bottom of the handset. If the contacts are clean and the handset is still powering up, please go to Plan B
- 4 Press any key on the PC keyboard. Wait until the message `Boot code downloaded` appears. Now, you can release the button on the handset for powering up.
- 5 Wait until the text `Successful upgrade` appears. The software has now been transferred to the handset. The version of the software can be identified by pressing `*99982* Mute ( )`.

**Program Flash - Plan B**

Go through the steps below if the handset turns on, and the contacts are clean.

- 1 Click `OK`. Load of Flash has now started.
- 2 Wait until the text `Program progress ind` appears before releasing the button.
- 3 Wait until the text `Stop Program Ind` appears and the text turns into green.

**Error Message**

If an error occurs during upload of the software, and the message `Upload of software failed` it might not be possible to power up the handset afterwards. If it is not possible to turn on the handset, please go through the following steps:

- 1 Remove the battery of the handset.
- 2 Insert the battery again.

- 3 Repeat the above steps (1 - 5) for Program Flash.

## Load Flash KIRK 40xx Handset

This section describes how to load flash to the KIRK 40XX Handset. Please go through the following steps:

- 1 Press the Program Flash button, and follow the instructions you receive from the program.
- 2 Turn off the KIRK Handset when you receive the message Turn off PP.
- 3 Press the button for powering up the handset and keep it pressed when you receive the message Turn on power to target and press any key. The handset is not supposed to power up. If this happens, clean the contacts at the bottom of the handset.
- 4 Click OK. Load of Flash has now started.
- 5 Wait until the text Program progress ind appears before releasing the button.
- 6 Wait until the text Stop Program Ind appears and the text turns into green. The software has now been transferred to the handset. The version of the software can be identified by pressing \*99982\* Mute ( ).

### Error Message

If an error occurs during upload of the software, and the message Upload of software failed it might not be possible to power up the handset afterwards. If it is not possible to turn on the handset, please go through the following steps:

- 1 Remove the battery of the handset.
- 2 Insert the battery again.
- 3 Repeat the above steps (1 - 5) for Program Flash.

## Load Flash KWS500

This section describes how to load flash to the KWS500, 1.8GHz. Please go through the following steps:

- 1 Power down the system
- 2 Remove the front cover.
- 3 Place jumper BOOT-STRAP.
- 4 Connect the KWS500 to PC using the serial cable.
- 5 Press the button Program Flash and follow the instructions you receive from the program.
- 6 Select the file to load to the KWS500, and open the file.



- 7 Turn on the power and press any key on the PC. The load of software process has started and is indicated via the counter.
- 8 When Successful upgrade appears, the flash load is completed.
- 9 Power down the system.
- 10 Remove the BOOT STRAP jumper.
- 11 Power up the system and check that the software has been upgraded via the CCFP Adm. Program.

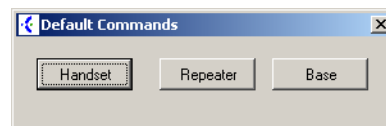
If it is necessary to clear the data in the system, please check Service News no. 55 re. this issue at [www.polycom.com](http://www.polycom.com).

## Default Commands

You are now able to select the type of unit which has to be set up to factory default settings.

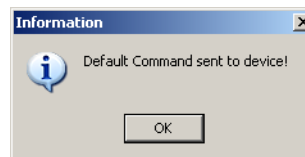
Example: Select Handset and wait until a dialog box appears giving the information that the Default Command has been sent to device.

**Figure 4-3** ServiceTool Program: Default Commands Window



As soon as the below window appears, the unit has been set up to factory default settings

**Figure 4-4** ServiceTool Program: Default Command Completed Window

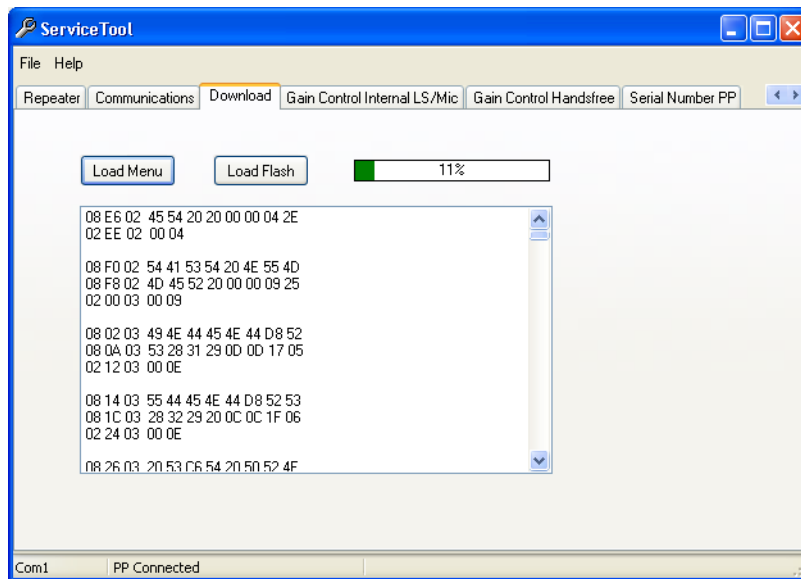


## KIRK Load Menu

In this section, you will find information on how to load Menu (in case of a new menu, e.g. when adding a new language to the menu) to the KIRK Handsets.

- 1 Click the Download tab, and the following window appears:

Figure 4-5 ServiceTool Download Page

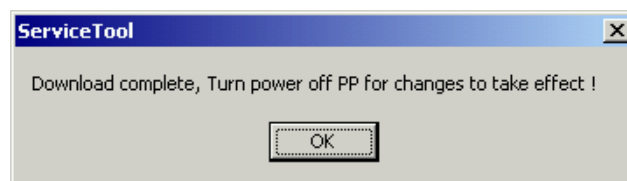


- 2 Press the Load Menu button.
- 3 Select the file to be uploaded to the handset. Data is now being transferred to the handset.

**Warning: When uploading the menu files, only use files with the extension Mnu. Other files might not be in the correct format, and can seriously damage the handset.**

- 4 When the upload of the menu file is complete the following dialog box appears:

Figure 4-6 ServiceTool Download Complete Dialog Box



Click ok.

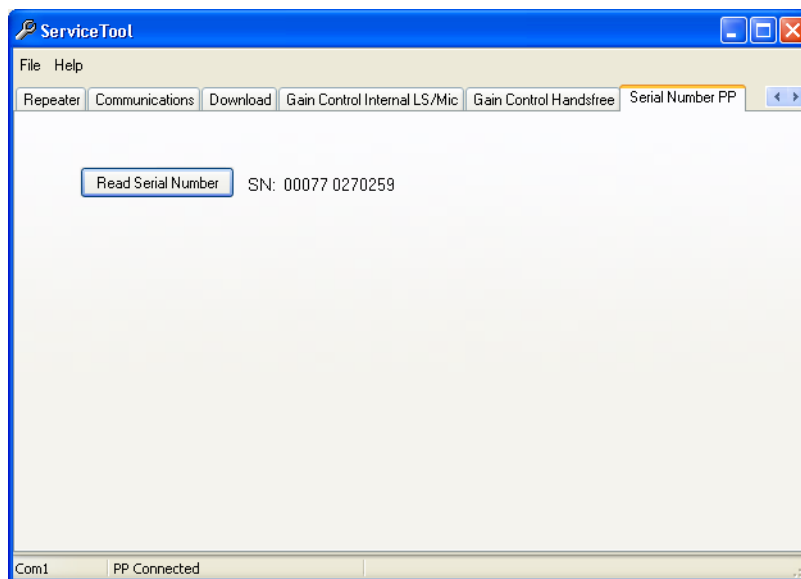
---

## Serial Number of the KIRK Handset

This section describes how to identify the serial number (IPEI) of a KIRK Handset using the ServiceTool program. If it is not possible to identify the serial number of a KIRK handset (e.g. the label has disappeared), this function is very useful.

- 1 Make sure, that the connection to the handset has been established (Described in “KIRK Repeater and Base Station Programming” on page 2-1) .
- 2 Click the Serial Number PP tab, and then click the Read Serial Number button. The following window appears:

*Figure 5-1 ServiceTool Serial Number PP Page*



### Identify Handset IPEI No. on the Handset Display

This section describes an alternative method of identifying the serial no. of the handset

KIRK 3040 Handset: On the handset, press **\*99984\*/Mute/ ( )**.

KIRK 40XX Handset: On the handset, press **\*\*\*\*/Redial (<)**.

Depending on the software version, identifying handset IPEI no. on the handset display is possible/not possible.

---

# Warnings

In this section, you will be guided to different sections where warnings are given. The warnings are highlighted in red.

## Repeater Numbering Warnings

Repeater Numbering - KWS 300, KWS500 and KCS in [Table 2-2](#) on page 2-5

Repeater Numbering - KWS600v3, Single Cell, in [Table 2-3](#) on page 2-9

Repeater Numbering - KWS600v3, Multi Cell, and KWS6000 in [Table 2-4](#) on page 2-13

Repeater Numbering - KWS1500 and KWS8000/1.8GHz in [Table 2-5](#) on page 2-17

## Load Menu Warnings

Load Menu on [page 6](#), chapter 4

## Hot Spot Warnings

Hot Spot - KWS300, KWS500 and KCS on page 2-7

Hot Spot - KWS600v3, Single Cell Solution on page 2-12

Hot Spot - KWS600v3, Multi Cell Solution, and KWS6000 on page 2-15

Hot Spot - KWS1500 and KWS8000/1.8GHz on page 2-19

## Repeater Type Warnings

Repeater type used for KWS600v3 ([Figure 2-4](#) on page 2-8)

---

# Replacement of Logo and Icon

## Adding Personal Logo and Icon to the ServiceTool Program

It is possible to change the Polycom icon into a personal icon and to change the logo at the Welcome page of the ServiceTool Program. The files logo.bmp and user.ico can be distributed together with the installation disk. After installation of the program, the program has been personalized.

### Installation

- Replace the logo.bmp file and the user.ico  
Icon file must be named user.ico  
Picture file must be named: logo.bmp

If no Icon or Logo is found, the default Icon and Logo will be used.

---

# Language

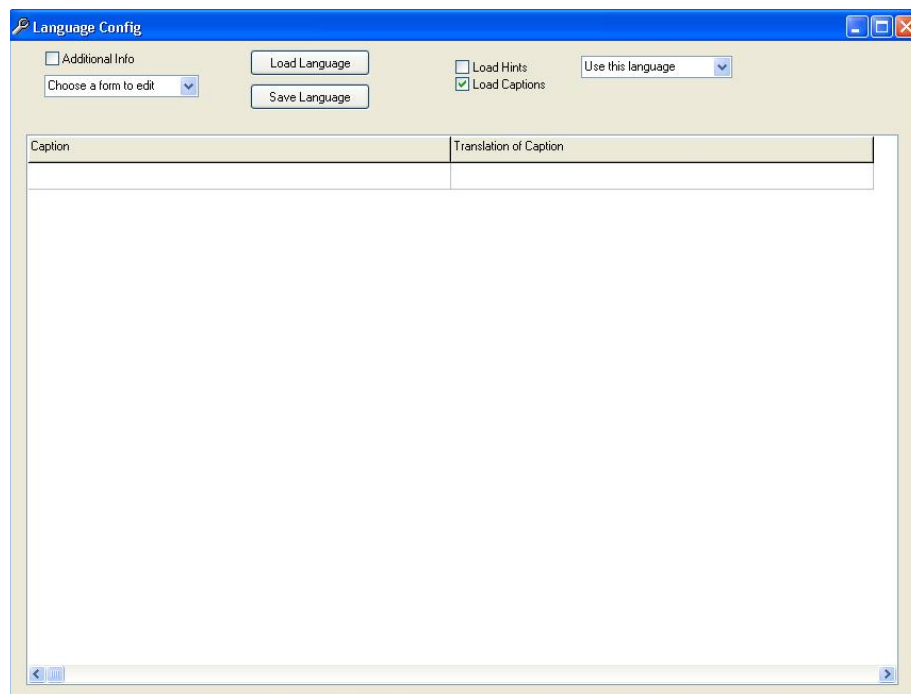
## Translation into Another Language

It is possible to translate all the text of the ServiceTool program into another language.

**Note:** It is recommended to use a language file to get a default language. If the ServiceTool program has been distributed with a language file (“Default.LNG”), this file will be used until another language is selected.

- 1 Click **Help** in the main window of the ServiceTool Program.
- 2 Click **Language** and the following window appears:

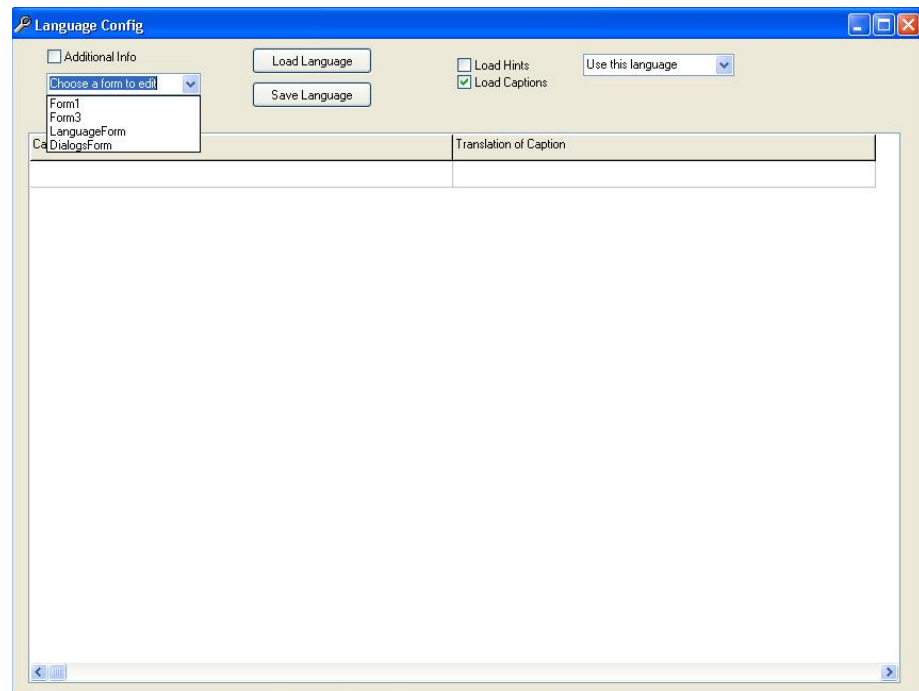
*Figure 8-1 “Choose a Form” to Edit Window of the ServiceTool Program*



- 3 Click the drop down list and the following window appears:

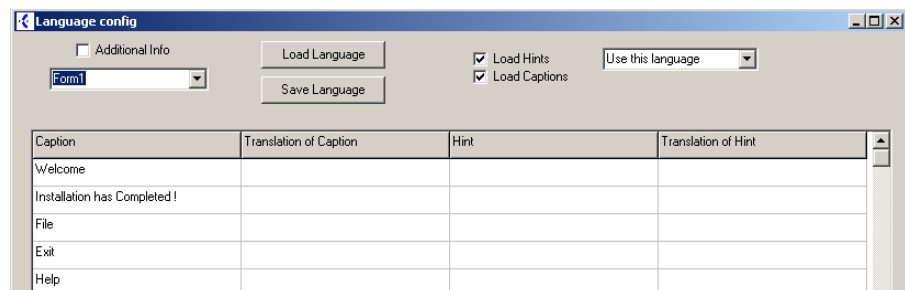


**Figure 8-2** Drop Down List Window of the ServiceTool Program



- 4 Click one of the selections, and the following window appears:

**Figure 8-3** Language Configuration of the ServiceTool Program



- 5 It is now possible to enter the translation.  
6 Click Save Language in order to save the translations.

---

# Latest Version of the ServiceTool Help File

In this section you will be introduced to the ServiceTool version of this help file as well as the changes made to the ServiceTool in the past.

## ServiceTool Program Version 4.19

The changes and facilities added or removed as well as corrected bugs can be found in the section Facilities Implemented and Bugs Corrected on page 9-2

## Replacement of the ServiceTool Help File

The actual help file is replaced with a new version of the ServiceTool help file when Polycom releases a new version of the ServiceTool program. As soon as a new version is available, it can be downloaded at [www.polycom.com](http://www.polycom.com).

The new ServiceTool help file has to be copied into the directory where the ServiceTool program is installed. Delete the old ServiceTool help file and rename the new file into ServiceTool.hlp.

Start up the new ServiceTool program, and the new ServiceTool help file will be implemented.

## Installation

The new ServiceTool help file can be distributed together with the installation disks. Replace the ServiceTool.hlp file on the disk. After the installation of the ServiceTool program the new ServiceTool help file will be implemented.

## Use of Help File Version 4.19 in Older Versions of the ServiceTool Program

An older version of the ServiceTool program is compatible with the ServiceTool help file version 4.19. Rename the file ServiceTool.hlp into KIRKTOOL.HLP and copy it into the directory where the KIRK Tool program has been installed.

**Note:** the edition of the help file is not necessarily similar to the edition of the ServiceTool program, as the help file can be changed without changing the basic ServiceTool program.

## Facilities Implemented and Bugs Corrected

In the following the actual and previous versions of the ServiceTool are presented including features removed, added, changed, etc.

### ServiceTool Program Version 4.19

In the Repeater tab of the ServiceTool program, the button Alternative Synchronization routes is added.

SpectraLink logo, etc., is replaced by the Polycom logo, name, etc.

### ServiceTool Program Version 4.18

Removed: Old KIRK icon from the packet.

Removed: Button to raise microphone gain by 6dB on the Gain Control page.

Removed: "Use boot loader with handset switched on" choice on the flash load page.

Changed: Misc. captions on buttons and labels from 1500/500/Residential to "Multi Cell System" and "Single Cell Base".

Changed: Name of pages "Gain Control" and "Gain Control 4040/4080" to "Gain Control Internal LS/Mic" and "Gain Control Handsfree".

Misc. smaller fixes and changes.

Text in help section in general corrected/changed/added.

#### **Important Text Added:**

The type of repeater used for the KWS600v3 is supposed to be the 4 ch (full slot) repeater. The older type of repeater equal to the 2 ch (single slot) repeater is not supposed to be used for the KWS600v3.

## ServiceTool Program Version 4.17

Changed: Text "40XX" changed into "4020/4040/4080", "4040/4080", "4020/4040" on the tabs "Startup Text PP" and "Gain Control 40..", and on the "Load Flash Utility" window.

Added: "1G9" on the "Communications" tab.

Changed: Logo changed from "KIRK" to "KIRK - a SpectraLink Company".

## ServiceTool Program Version 4.16

Support for KIRK 40xx 2.4GHz Handset is added.

## ServiceTool Program Version 4.15

Load of flash to the KIRK 3040 Handset - Hardware PCS 20 or above added in the tab Flash Load Utility.

Folder Communications extended.

3040 (HW PCS 20 and above) (115200 baud) added.

Description of load of flash to KWS500 is added in the .hlp file.

## ServiceTool Program Version 4.14

Read/Write to Eeprom Implemented (only for internal Polycom use).

## ServiceTool Program Version 4.13

The program can identify if a repeater is a 2 channel repeater or a 4 channel repeater.

Busy Bit and Debug Bip are implemented under Residential Base.

The text in the help section in general changed or added.

## ServiceTool Program Version 4.12

In the Load Flash tab a possibility of setting up units to default has been added.

## ServiceTool Program Version 4.11

The Load Flash tab has been extended.

Chapter handset 40XX = PP 40XX is changed, and divided into 2 sections (Method 1 and 2).

## ServiceTool Program Version 4.10

The **Load Flash** tab has been extended.

Load Flash to KWS500 1.8GHz has been added.

Load Flash to KWS500 2.4GHz has been added.

## ServiceTool Program Version 4.9

The **Gain Control 40XX** tab has been added.

In the **Flash Load Utility** tab, the number of comports has been extended to 10.

The **Load Flash** tab has been extended.

Load Flash to PP40XX has been added.

Load Flash to repeater 2.4GHz has been added.

The **Repeater programming system 1500 - 2.4GHz** tab has been added.

The **Hot Spot** tab has been added.

## ServiceTool Program Version 4.8

The possibility of choosing comport 1 - 10 has been added.

Baud Rate settings 8.600, 9.200 and 115.200 have been added.

Config.ini file for selecting which folder / tab pages to be visible / invisible has been added.

The config.ini file can be edited by e.g. NOTEPAD.

Guideline/instruction is given in Config.ini.

## ServiceTool Program Version 4.7

The **Serial Number PP** tab has been added.

The **Volume adjust PP** tab has been removed (can be activated from e.g. Dos Promt by using command ServiceTool.exe /va).

## ServiceTool Program Version 4.6

New help file added.

Debug bip added for programming of residential repeater.

New possibilities:

- Use under Windows XP added.
- Replacement of logo implemented.
- Change of icon implemented.
- Change of logo implemented.
- Translation to other languages implemented.

---

Figure 1-1	Hardware Configuration: Repeater and Base Station Programming Kit 1-2
Figure 2-1	Main Window of the ServiceTool Program ..... 2-2
Figure 2-2	Communications page of the ServiceTool Program ..... 2-3
Figure 2-3	Repeater Page of the ServiceTool Program ..... 2-4
Figure 2-4	Repeater Page of the Service Tool Program ..... 2-8
Figure 2-5	Repeater Page of the Service Tool Program ..... 2-12
Figure 2-6	Repeater Page of the ServiceTool Program ..... 2-16
Figure 2-7	Repeater Page of the ServiceTool Program ..... 2-20
Figure 2-8	Repeater Numbers in a Jump ..... 2-22
Figure 2-9	Repeater Numbers in a Jump ..... 2-23
Figure 2-10	Download Page of the ServiceTool Program ..... 2-24
Figure 2-11	Download - Load Flash Page of the ServiceTool Program ..... 2-25
Figure 2-12	Turn Power Off warning of the ServiceTool Program ..... 2-25
Figure 2-13	Turn on power warning of the ServiceTool Program ..... 2-25
Figure 3-1	ServiceTool Startup Text PP Page ..... 3-2
Figure 3-2	ServiceTool Gain Control Internal LS/Mic Page ..... 3-3
Figure 3-3	ServiceTool Gain Control Handsfree Page ..... 3-4
Figure 4-1	ServiceTool Download page ..... 4-1
Figure 4-2	ServiceTool Flash Load Utility Page ..... 4-2
Figure 4-3	ServiceTool Program: Default Commands Window ..... 4-5
Figure 4-4	ServiceTool Program: Default Command Completed Window .... 4-5
Figure 4-5	ServiceTool Download Page ..... 4-6
Figure 4-6	ServiceTool Download Complete Dialog Box ..... 4-6
Figure 5-1	ServiceTool Serial Number PP Page ..... 5-1
Figure 8-1	“Choose a Form” to Edit Window of the ServiceTool Program .... 8-1
Figure 8-2	Drop Down List Window of the ServiceTool Program ..... 8-2
Figure 8-3	Language Configuration of the ServiceTool Program ..... 8-2

---

Table 1-1	Repeater and Base Station Programming Kit . . . . .	1-1
Table 1-2	Serio Interface KIRK 3040 Handset . . . . .	1-2
Table 1-3	Cable Kit KIRK 40xx Handset . . . . .	1-3
Table 2-1	Baudrate Settings . . . . .	2-3
Table 2-2	Data Fields of the Repeater page of the KWS500 . . . . .	2-5
Table 2-3	Data Fields of the Repeater Page of the KWS600v3, Single Cell . . . .	2-9
Table 2-4	Data Fields of the Repeater Page of the KWS600v3, Multi Cell . . . .	2-13
Table 2-5	Data Fields of the KWS1500 and KWS8000 . . . . .	2-17
Table 2-6	Data Fields of the Alternative Synchronization Ways . . . . .	2-20
Table 2-7	Units Available for Repeater Jump . . . . .	2-21
Table 2-8	Repeater Numbers in a Jump . . . . .	2-22
Table 2-9	Repeater Numbers in a Jump . . . . .	2-23
Table 3-1	Data Fields of the Startup Text PP Page . . . . .	3-2