



Grandstream Networks, Inc.

GXV3674_HD_VF/GXV3674_FHD_VF

Outdoor Day/Night Vari-focal HD IP Camera



TABLE OF CONTENTS
GXV3674_HD/FHD_VF User Manual

WELCOME.....	4
SAFETY COMPLIANCES.....	5
WARRANTY.....	6
CONNECT YOUR GXV3674_HD/FHD_VF	7
EQUIPMENT PACKAGE CONTENTS.....	7
CONNECTING THE GXV3674_HD/FHD_VF	8
PRODUCT OVERVIEW	9
GXV3674_HD/FHD_VF CAMERA	9
GXV3674_HD/FHD_VF SPECIFICATIONS	10
INSTALLATION GUIDE	11
MINIMUM RECOMMENDED COMPUTER SYSTEM REQUIREMENT.....	11
CONFIGURE THE GXV3674_HD/FHD_VF VIA WEB BROWSER.....	11
GXV3674_HD/FHD_VF HOME WEB PAGE	14
GXV3674_HD/FHD_VF CONFIGURATION & LANGUAGE PAGE	15
BASIC SETTINGS EXPLANATION	16
SYSTEM SETTINGS PAGE	16
VIDEO & AUDIO SETTING PAGE	17
CMOS SETTINGS PAGE.....	20
NETWORKING SETTING PAGE.....	21
DDNS SETTINGS PAGE	22
SIP SETTING PAGE.....	23
STATUS PAGE.....	25
ADVANCED SETTINGS EXPLANATION.....	26
USER MANAGEMENT PAGE.....	26
MAINTENANCE PAGE.....	27
SMTP SETTING PAGE (EMAIL ALARM).....	28
FTP SETTINGS PAGE (UPLOAD ALARM).....	30
ALARM SERVER SETTINGS PAGE (UPLOAD ALARM TO SUPPORTED VMS OR HTTP SERVER)	31
MOTION DETECTION CONFIGURATION PAGE (SET ALARM)	32
SYSLOG SETTINGS PAGE (TROUBLESHOOTING)	34
SOFTWARE UPGRADE	35
SOFTWARE UPGRADE VIA TFTP, HTTP OR HTTPS.....	35
INSTRUCTIONS FOR LOCAL FIRMWARE UPGRADE USING TFTP SERVER:	36
CONFIGURATION FILE DOWNLOAD	36
RESTORE FACTORY DEFAULT SETTING.....	37
RESET FROM WEB INTERFACE.....	37
IP SURVEILLANCE FAQ	38

TABLE OF FIGURES
GXV3674_HD/FHD_VF USER MANUAL

FIGURE 1: HOME PAGE OF GXV3674_HD/FHD_VF	14
FIGURE 2: WEB LANGUAGE SWITCH	15
FIGURE 3: SYSTEM SETTINGS PAGE.....	16
FIGURE 4-1: VIDEO & AUDIO SETTINGS PAGE.....	17
FIGURE 4-2: VIDEO & AUDIO SETTINGS PAGE.....	18
FIGURE 5: CMOS SETTINGS PAGE.....	20
FIGURE 6: NETWORKING SETTING PAGE.....	21
FIGURE 7: DDNS SETTING PAGE.....	22
FIGURE 8-1: SIP SETTING PAGE.....	23
FIGURE 8-2: SIP SETTING PAGE.....	24
FIGURE 9: STATUS PAGE.....	25
FIGURE 10: USER MANAGEMENT PAGE	26
FIGURE 11: MAINTENANCE PAGE	27
FIGURE 12: SMTP SETTING PAGE	28
FIGURE 13: FTP SETTING PAGE.....	30
FIGURE 14: ALARM HTTP SERVER SETTING PAGE	31
FIGURE 15-1: MOTION DETECTION CONFIGURATION PAGE.....	32
FIGURE 15-2: MOTION DETECTION SCHEDULE CONFIGURATION PAGE.....	33
FIGURE 16: ALARM SERVER SETTING PAGE	34
FIGURE 17: FIRMWARE UPGRADE AND PROVISIONING	35
FIGURE 18: FACTORY RESET FROM WEB INTERFACE	37

TABLE OF TABLES
GXV3674_HD/FHD_VF USER MANUAL

TABLE 1: GXV3674_HD/FHD_VF TECHNICAL SPECIFICATIONS.....	10
----------------------------------------------------------	----

WELCOME

Thank you for purchasing Grandstream's GXV3674 series Outdoor Day/Night Vari-focal High Definition IP Camera, an innovative powerful weatherproof infrared next generation high definition network camera. Its advanced ISP (Image Sensor Processor) powered with state-of-the-art auto-exposure/auto-white-balance algorithm and a high quality lens, ensures high fidelity video quality that matches digital still camera color grade in a wide range of light environments. It features cutting edge H.264 real-time video compression with excellent image clarity (720p for GXV3674_HD_VF; 1080p for GXV3674_FHD_VF) and color fidelity, industry leading SIP/VoIP for 2-way audio and video streaming to smartphones and video phones, integrated PoE, IR-CUT (mechanical) for day or night mode, and advanced security protection using strong encryption. The GXV3674_HD/FHD_VF can be managed with GSurf_Pro, Grandstream's intuitive FREE VMS (video management systems) software that controls up to 36 cameras (*) simultaneously. It is fully compliant with ONVIF standard and offers flexible HTTP API and an SDK for advanced integration.

Designed for weatherproof applications, the GXV3674_HD/FHD_VF Outdoor Day/Night Vari-focal HD IP camera is a new addition to the popular GXV3XXX series IP surveillance product family. It ensures ease of use, integration and deployment, with multilingual graphical user interface, provides powerful solution to professional surveillance applications.

This manual will help you to learn how to operate and manage your GXV3674_HD/FHD_VF Outdoor Day/Night Vari-focal HD IP camera and make the best use of it.

Safety Compliances

These instructions are intended to assist users with the operation of the GXV3674_HD/FHD_VF and to instruct on how to avoid dangerous situations or damage to the device.

Warnings: Serious injury or death may be caused if any of the warnings below are neglected.
Cautions: Injury or damage to the equipment may occur if any of the following caution messages are neglected.



Warnings Follow these safeguards to prevent serious injury or death.



Cautions Follow these precautions to prevent potential injury or material damage.



Warnings:

Input voltage should meet both the SELV (Safety Extra Low Voltage) and the Limited Power Source with DC 12V according to the IEC60950-1 standard. Please refer to the technical specifications for more details.

Do not use a third-party power adapter or power cord

When the device is installed on the wall or ceiling, make sure that it is firmly attached.



Notice,

Make sure that the power supply voltage is correct before using the camera.

Do not drop the device or expose it to physical shock.

Do not expose the device to temperatures outside the range of -10°C to +60°C when the device is in operation.

Do not expose the device to damp/wet conditions or high electromagnetism radiation.

To avoid heat accumulation, make sure that your operating environment has proper ventilation.

Do not attempt to open, disassemble, or modify the device

A few parts (e.g. electrolytic capacitor) of the equipment shall be replaced regularly according to their average life time. The average life time varies from the differences between operating environments and usage history. Regular maintenance checks are recommended for all users. Please contact your dealer for more details.

Warranty

If you purchased your GXV3674_HD/FHD_VF from a reseller, please contact the company where you purchased the device for replacement, repair or refund.

If you purchased the product directly from Grandstream, please contact your Grandstream Sales and Service Representative for a RMA (Return Materials Authorization) number before you return the product. Grandstream reserves the right to remedy warranty policy without prior notification.

Caution:

Changes or modifications to this product not expressly approved by Grandstream, or operation of this product in any way other than as detailed by this User Manual, could void your manufacturer warranty. Please do not use a different power adaptor with the GXV3674_HD/FHD_VF as it may cause damage to the products and void the manufacturer warranty.

- This document is subject to change without notice. The latest electronic version of this user manual is available for download at:
http://www.grandstream.com/products/surveillance/GXV3610hd/documents/GXV3674_HD/FHD_VF_usermanual_english.pdf

Reproduction or transmittal of the entire or any part, in any form or by any means, electronic or print, for any purpose is not permitted without the express written permission of Grandstream Networks, Inc.

CONNECT YOUR GXV3674_HD/FHD_VF

Equipment Package Contents

The GXV3674_HD/FHD_VF package contains:

- GXV3674_HD/FHD_VF IP Camera
- 12V DC Universal Power Adaptor
- Ethernet Cable
- 1 Hex Key and 4 Screws and Wall Anchors
- Quick Installation Guide



1 x GXV3674_HD/FHD_VF



1 x 12V Power Supply



1 x Ethernet Cable



4 x Wall Anchors



4 x Screws



1 x Hex Key



1 x Quick Start Guide

Connecting the GXV3674_HD/FHD_VF

Using the Power Adapter as power supply

- Connect the RJ-45 Ethernet cable to the NETWORK port of the GXV3674_HD/FHD_VF
- Connect the other end of the RJ-45 cable to your network (switch or router or PC)
- Connect the power supply to the DC 12V power jack on the back of the GXV3674_HD/FHD_VF

Using PoE as power supply

- Connect the RJ-45 Ethernet cable to the NETWORK port of GXV3674_HD/FHD_VF
- Connect the other end of the RJ-45 cable to your PoE switch.

Please refer to following connection diagram to hook up the camera.

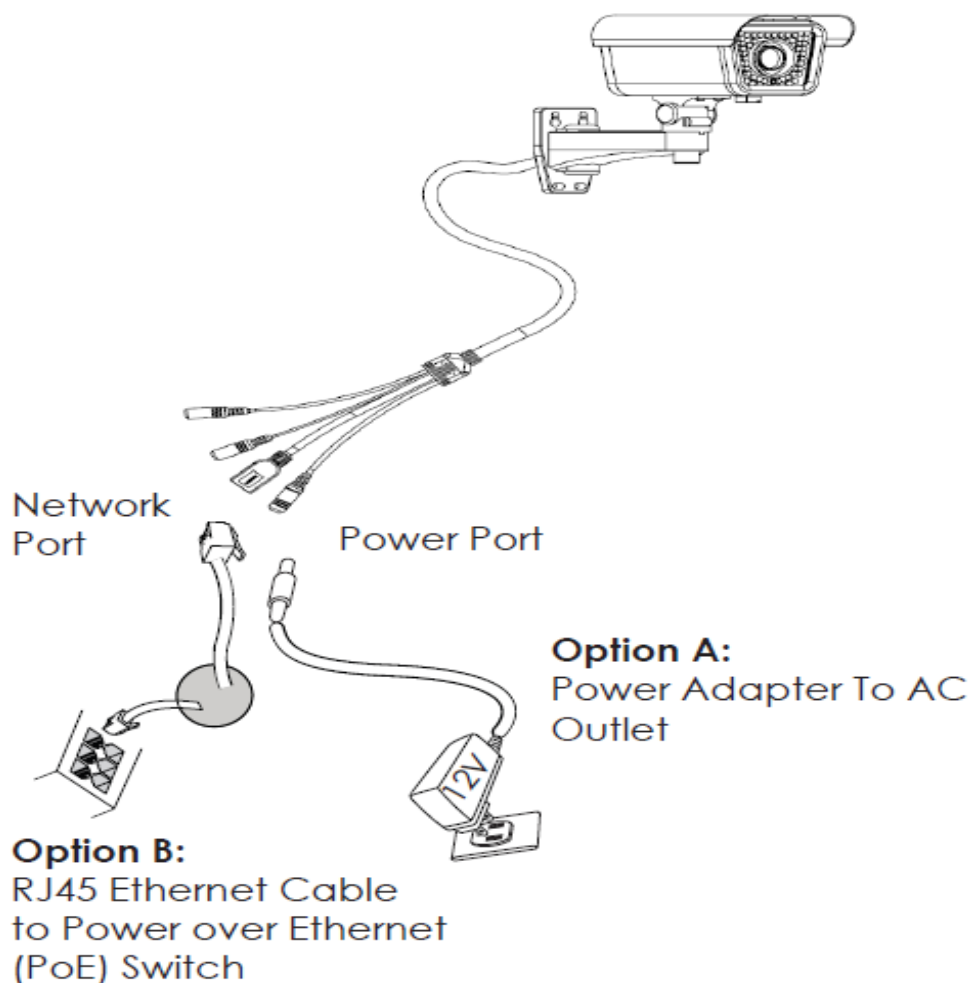

NOTE: Choose Option A if using the power supply; or choose Option B if using a Power over Ethernet (PoE) switch.

Product Overview

GXV3674_HD/FHD_VF Camera

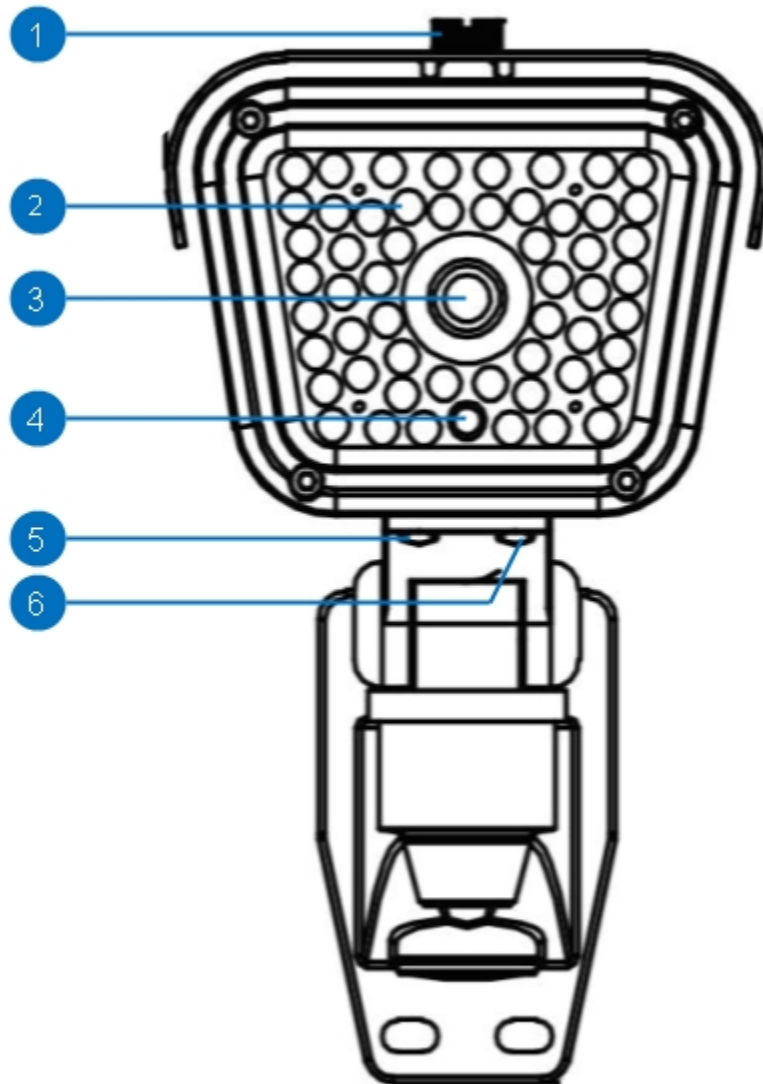

- 1. ***Screw and Top Cover***
- 2. ***IR LED Light***
- 3. ***LENs***
- 4. ***IR CUT Sensor***
- 5. ***Far/Near Adjustment***
- 6. ***Focus Adjustment***

GXV3674_HD/FHD_VF screw and top cover
IR LED light for night mode
Adjustable Vari-focal Lens
IR-Cut Photonic Sensor
Light Sensor for mechanical IR-Cut switching

GXV3674_HD/FHD_VF Specifications

Table 1: GXV3674_HD/FHD_VF Technical Specifications

Model	GXV3674_HD_VF	GXV3674_FHD_VF
Video Compression	H.264, MJPEG	
Image Sensor Resolution	1/3", 1.2 Megapixel Progressive Scan CMOS, 1280H x 960V	1/3", 3.1 Megapixel Progressive Scan CMOS, 2048H x 1536V
Image Sensor Sensitivity	Day & night mode, exceptionally low noise levels and low-light sensitivity. Shutter: 1/10000 – 1/30 second	
Focal Length	2.8 ~ 12 mm	
Aperture	F1.4, DC-IRIS	
Field Angle (FOV)	90° ~ 28° (Horizontal Field)	
IR Cut Filter	Yes, Mechanical	
Day & Night Mode	IR LED covering up to 25m	
Minimum Illumination	0.05 Lux, 0 lux with IR	
Responsivity	5.48V/lux-sec (550nm)	1.9V/lux-sec (550nm)
Pixel Dynamic Range	Wide Dynamic Range of 120dB with SNR _{MAX} 44dB	Wide Dynamic Range of 100dB with SNR _{MAX} 39dB
Supported Maximum Video Resolution and Frame Rate	1280x960 (25fps) 1280x720 (30fps)	2048x1536 (15fps) 1920x1080 (30fps)
Video Bit Rate	32 Kbps ~ 8 Mbps, multi-rate for preview & recording	
Audio Input	Line-In, 1500 ohms, 0.1Vrms ~ 0.707Vrms	
Audio Output	Line-Out, 600 ohms, 0.707Vrms	
Audio Compression	G.711u/a, AAC	
Embedded Analytics	Motion Detection (up to 16 target areas)	
Pre-/post-alarm Buffer	8MB	3MB
Snapshots	Triggered upon events, send via email/FTP	
Network Protocol	TCP/UDP/IP, RTP/RTCP, RTSP, DHCP, DDNS, HTTP, HTTPS, SMTP, FTP, NTP	
SIP/VoIP Support	Yes	
Power over Ethernet (PoE)	IEEE 802.3af, Class 0	
External Cable Connection	Network: RJ45, 10M/100M auto-sensing 3.5mm Line-In 3.5mm Line-Out Power Input	
Dimensions (L x W x H)	255mm (L) x 104mm (W) x 187mm (H)	
Weight	1.10kg	
Temperature / Humidity	Operating: -20°C ~ +50°C (-4°F ~ 122°F), 10–90% RH (non-condensing) Storage: -30°C ~ +60°C (-22°F ~ 140°F)	
Power Adapter	Output: 12VDC/1A; Input: 100–240VAC, 50–60Hz	
Casing	IP66 compliant weather-proof metal case	
Compliance	FCC Part 15, Subpart B Class B; EN 55022 Class B, EN 61000-3-2, EN 61000-3-3, EN 55024, EN 60950-1; C-tick AS/NZS CISPR 22	

INSTALLATION GUIDE

Minimum Recommended Computer System Requirement

To install GXV3674_HD/FHD_VF, you have to have a computer, PC recommend. The minimum recommended PC system requirement listed below:

- Windows XP, Windows Vista, Windows 7 and Windows 8
- CPU: Intel Pentium 4 or higher, 2 GHz
- RAM: 1 GB (4 GB recommended for larger systems)
- Support for DirectX 8.0 and above.

Configure the GXV3674_HD/FHD_VF via Web Browser

The GXV3674_HD/FHD_VF has embedded Web server to respond to HTTP GET/POST requests. Embedded HTML pages allow user to configure the IP camera through Microsoft Internet Explorer (7.0 or above), Firefox and Chrome (plug-in from Grandstream required).

- Download Plug-in from Grandstream website:
http://www.grandstream.com/products/tools/surveillance/webcontrl_plugin.zip

NOTE:

- *Apple Safari is NOT yet supported and status pending.*
- *Please temporarily disable Antivirus or Internet Security Software when download and install the Grandstream Plug-in Software.*

Connect the Camera to network with DHCP server (Recommended)

The GXV3674_HD/FHD_VF by default enabled as DHCP client, it will automatically get IP address from the network with DHCP server running. User can know the IP address assigned to the camera from DHCP server log or using “SearchTool” from Grandstream GSurf_Pro free VMS software.

1. Download and install the GSurf_Pro software from Grandstream website:
http://www.grandstream.com/products/tools/surveillance/gsurf_pro.zip
2. Run the “Search Tool” in the pull down Menu of “Manage Tool” tag
3. Click on  button to begin device detection
4. The detected devices will appear in the Output field like below

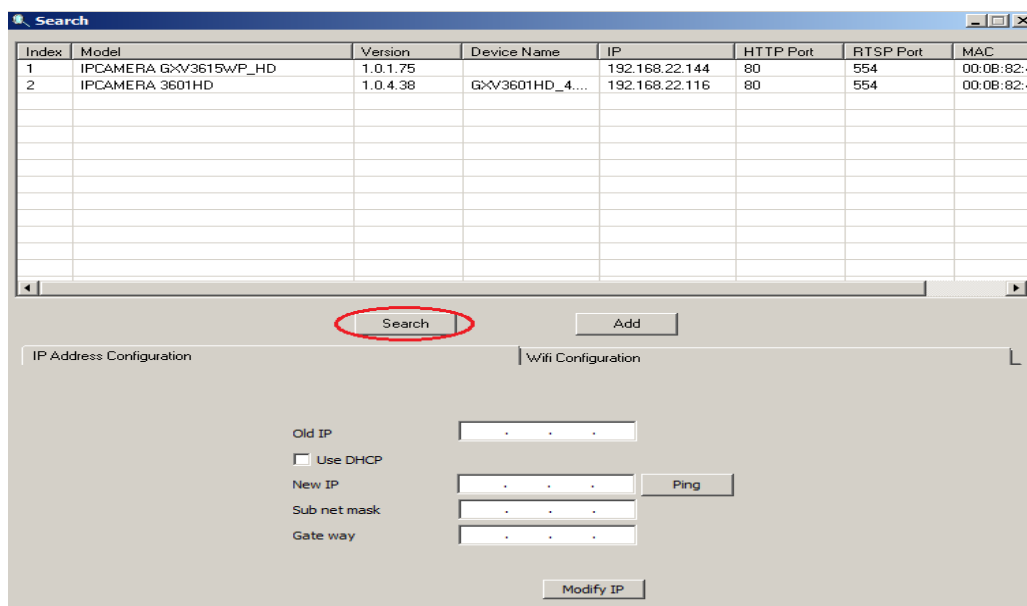

5. Double click the column of the detected camera, the browser will automatically open and link to the device IP and the web configuration page.
6. The browser will ask for plug-in or ActiveX if not installed, otherwise it will get to Home page and start to show the video captured by the camera (by default the camera enabled anonymous access)
7. Click “Configuration”, the browser will ask credentials to authorize configuration.
8. Enter the administrator user name and password to access the Web Configuration Interface, the default user name and password are both set to **admin**.
9. In step 6, browser will indicate that “This website wants to install the following add-on: GSViewerX.cab from Grandstream Networks Inc.”, allow the installation.
10. The plug-in can be download here:
http://www.grandstream.com/products/tools/surveillance/webcontrl_plugin.zip

NOTE:

- Please temporarily disable Antivirus or Internet Security Software and close all browsers when download and install the Grandstream Plug-in Software.

Connect to the Camera using Static IP

If no DHCP server in the network, or the camera does not get IP from DHCP server, user can connect the camera to a computer directly, using static IP to configure the camera.

The default IP, if no DHCP server; or DHCP offer time out (3 minutes), is **192.168.1.168**

1. Connect the computer RJ-45 via an Ethernet cable directly to the IP camera GXV3674_HD/FHD_VF.
2. Configure the computer using Static IP: 192.168.1.XXX (1<XXX<255, but NOT 168) and configure the “Subnet mask” to “255.255.255.0”. Leave the “Default Gateway” to “Blank” like below:

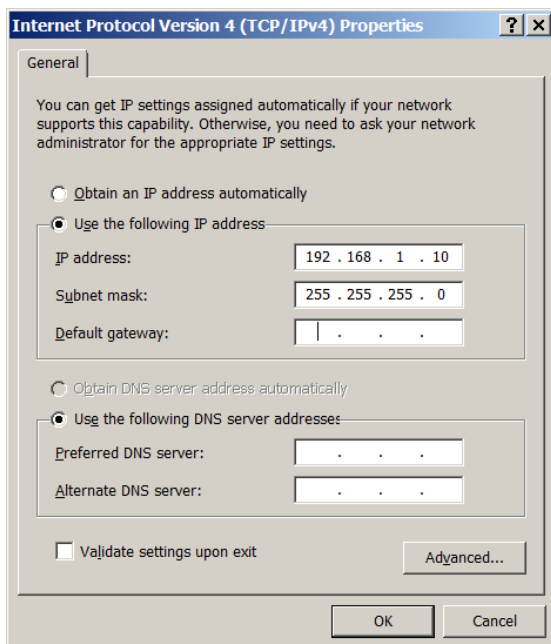

3. Power on the GXV3674_HD/FHD_VF.
4. Start the browser when the network connection is up.
5. Enter 192.168.1.168 in the address bar of the browser.
6. The browser will ask for plug-in or ActiveX if not installed, otherwise it will get to Home page and start to show the video captured by the camera (by default the camera enabled anonymous access)
7. Click “Configuration”, the browser will ask credentials to authorize configuration.
8. Enter the administrator user name and password to access the Web Configuration Interface, the default user name and password are both set to **admin**.
9. The plug-in can be downloaded from here:

http://www.grandstream.com/products/tools/surveillance/webcontrl_plugin.zip

NOTE:

- *Please temporarily disable Antivirus or Internet Security Software and close all browsers when download and install the Grandstream Plug-in Software.*

GXV3674_HD/FHD_VF Home Web Page

The Home Page of GXV3674_HD/FHD_VF shown as Figure 1:

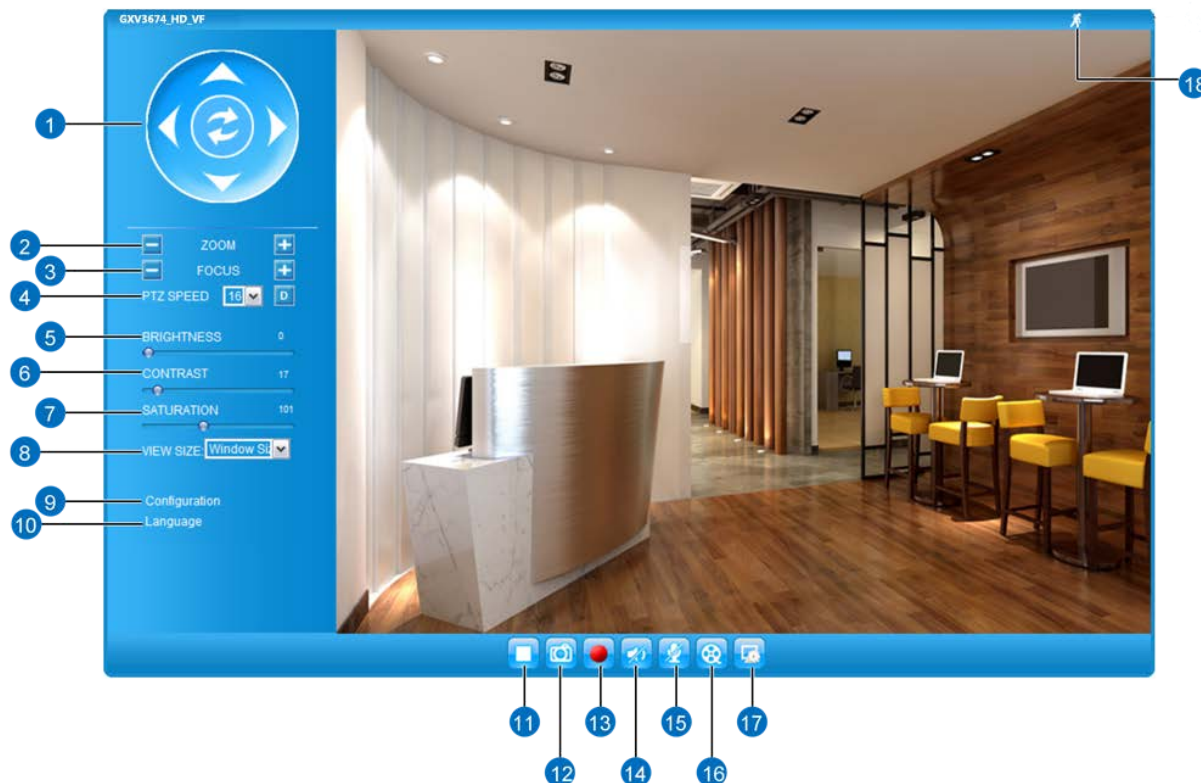

Figure 1: Home Page of GXV3674_HD/FHD_VF

- | | |
|-------------------------------------------------------------------------------------------------------------------------------------------------------------------------------------------------------------------------------------------------------------------------------------------------------------------------------------------------------------------------------------------------------------------------------------------------------------------------------------------------------------------------------------------------------------------------------------------------------------------------------------------------------------------------|-----------------------------------------------------------------------------------------------------------------------------------------------------------------------------------------------------------------------------------------------------------------------------------------------------------------------------------------------------------------------------------------------------------------------------------------------------------------------------------------------------------------------------------------------------------------------------------------------------------------------------------------------------------------------------------------------------------------------------------------------------------------------------------------------------------------------------------------------------------------------------------------------------------------------------------------------------------------------------------------------------------------------------------------------------------------------------------------------------------------------------------------------------------------------------------------------------------------------------------------------------------------------------------------------------------------------------------------------------------------------------------------------------------------------------------------------------------------------------------------------------------------------------------------------------------------------------------------------------------------------------------|
| <ol style="list-style-type: none"> 1. Control Console: 2. ZOOM: 3. FOCUS: 4. PTZ SPEED/Default Button:
“D” 5. BRIGHTNESS: 6. CONTRAST: 7. SATURATION: 8. View Size: 9. Configuration: 10. Language: 11. Play/Stop: 12. Snapshot Capture: 13. Record: 14. Sound On/Off: 15. Talk: 16. Playback: 17. Local Configuration: 18. Motion Detection Alarm Indicator: | <p>PTZ Console controller for ePTZ function.</p> <p>Zoom in or Zoom out during ePTZ operation.</p> <p>Adjust the focus of image (Not Applicable to GXV3674_HD/FHD_VF).</p> <p>Adjust the rotate speed of the control console (Not Applicable); “Default Button” to reset the video brightness, contrast and saturation value from (auto or manual) adjusted value to factory default value.</p> <p>Adjust the image or video brightness.</p> <p>Adjust the image or video contrast.</p> <p>Adjust the image or video saturation.</p> <p>Adjust the size of viewed image or video</p> <p>Click to enter “Configuration Page” to configure the parameters of GXV3674_HD/FHD_VF (Administration privilege required).</p> <p>Click to switch webpage language.
(Current support: Chinese, English and Russian)</p> <p>Start/Stop playing the video stream at embedded webpage.</p> <p>Click to capture and save a snapshot of current video frame displayed.
Default directory: C:\Capture</p> <p>Click to Start/Stop record of current video stream into a file.
Default directory: C:\Record</p> <p>Toggle to listen/stop the sound from camera microphone</p> <p>Toggle to talk to camera speaker if provided. (PC microphone and related speaker hardware required)</p> <p>Click to playback the recorded video file.</p> <p>Click to configure the file path of snapshot and recorded video files.
Also adjust the video delay or smoothness.</p> <p>If motion detection alarm triggered, the indicator will flash in red (if configured). Click the indicator icon to turn off the alarm indication.</p> |
|-------------------------------------------------------------------------------------------------------------------------------------------------------------------------------------------------------------------------------------------------------------------------------------------------------------------------------------------------------------------------------------------------------------------------------------------------------------------------------------------------------------------------------------------------------------------------------------------------------------------------------------------------------------------------|-----------------------------------------------------------------------------------------------------------------------------------------------------------------------------------------------------------------------------------------------------------------------------------------------------------------------------------------------------------------------------------------------------------------------------------------------------------------------------------------------------------------------------------------------------------------------------------------------------------------------------------------------------------------------------------------------------------------------------------------------------------------------------------------------------------------------------------------------------------------------------------------------------------------------------------------------------------------------------------------------------------------------------------------------------------------------------------------------------------------------------------------------------------------------------------------------------------------------------------------------------------------------------------------------------------------------------------------------------------------------------------------------------------------------------------------------------------------------------------------------------------------------------------------------------------------------------------------------------------------------------------|

GXV3674_HD/FHD_VF Configuration & Language Page

- When click the “Configuration” tab, web page will link to page to configure the related parameters of the GXV3674_HD/FHD_VF.
- There are two big categories of settings: Basic Settings and Advanced Settings. Details will be illustrated in the later Chapter.
- When click the “Language” tab, supported languages will be displayed in Figure 2. Click to select the related webpage display language.

Figure 2: Web Language Switch



- Currently firmware only support: English (default), Simplified Chinese and Russian.

BASIC SETTINGS EXPLANATION

System Settings Page

This page allow user to configure the system settings of GXV3674_HD/FHD_VF.

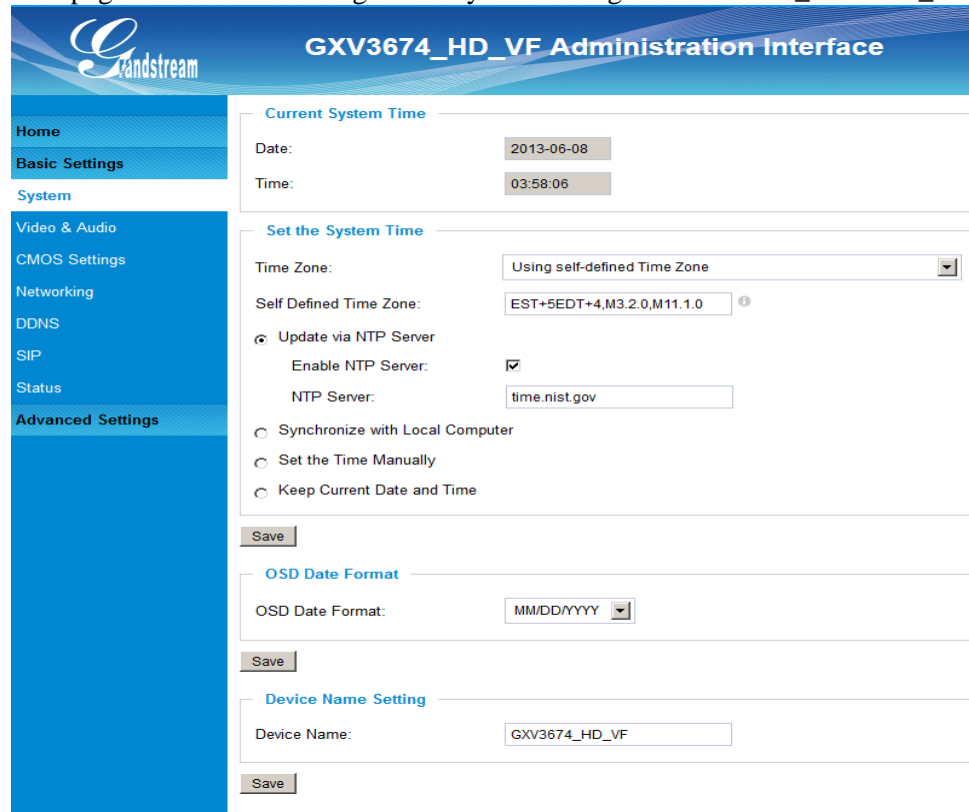

Figure 3: System Settings Page

- **Current System Time:** Display time current system is running at
- **Set the System Time:** Configure the time system is running.
 - Time Zone: Select from pull down menu the time zone unit located
 - Self-Defined Time Zone: Use the self-defined time zone for automatic daylight saving time adjustment. Format please refer to the “help over mouse”
 - Update via NTP Server: Synchronize time using NTP protocol with a Time Server over the Internet cloud (*)
 - Synchronize with Local Computer: Synchronize time with local computer
 - Set the Time Manually: Manually input the time
 - Keep Current D/T: Select to use camera current displayed time
- **OSD Date Format:** Pull down to select date format displayed on video screen
- **Device Name:** The name of device which will be shown in the result of “Search Tool” of GSurf_Pro VMS program.

NOTE:

(*) If select this option, a valid DNS server must be preconfigured under **Basic Settings** → **Networking**

➤ **Save** button has to be clicked to save all the changes made to the device.

Video & Audio Setting Page

This page allows user to configure the video and audio related settings.

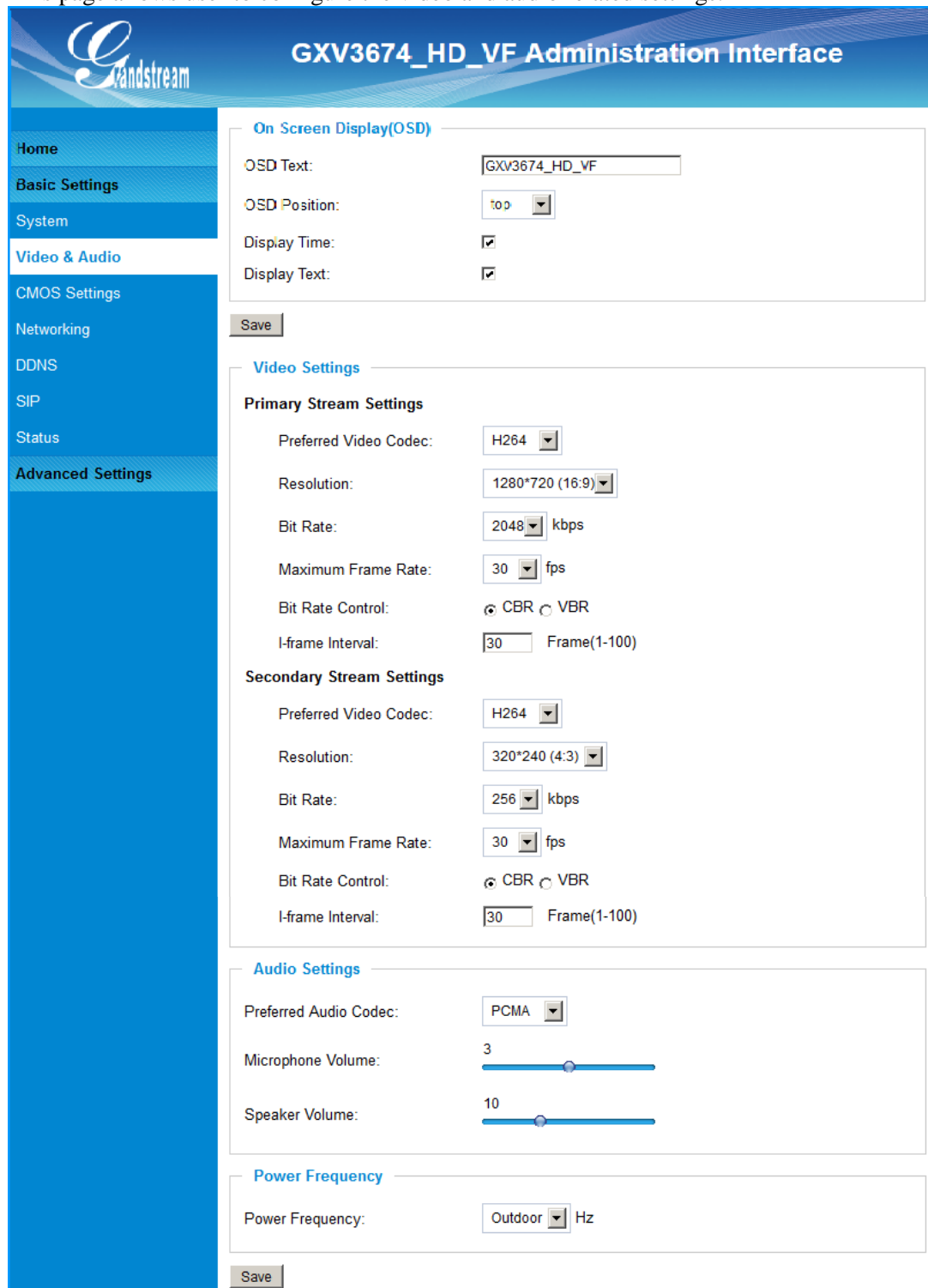

The screenshot displays the 'GXV3674_HD_VF Administration Interface' with a sidebar menu on the left. The 'Video & Audio' section is active, showing three main configuration panels: 'On Screen Display(OSD)', 'Video Settings', and 'Audio Settings'. Each panel includes a 'Save' button.

On Screen Display(OSD)

- OSD Text: GXV3674_HD_VF
- OSD Position: top
- Display Time:
- Display Text:

Video Settings

Primary Stream Settings

- Preferred Video Codec: H264
- Resolution: 1280*720 (16:9)
- Bit Rate: 2048 kbps
- Maximum Frame Rate: 30 fps
- Bit Rate Control: CBR VBR
- I-frame Interval: 30 Frame(1-100)

Secondary Stream Settings

- Preferred Video Codec: H264
- Resolution: 320*240 (4:3)
- Bit Rate: 256 kbps
- Maximum Frame Rate: 30 fps
- Bit Rate Control: CBR VBR
- I-frame Interval: 30 Frame(1-100)

Audio Settings

- Preferred Audio Codec: PCMA
- Microphone Volume: 3
- Speaker Volume: 10

Power Frequency

- Power Frequency: Outdoor Hz

Figure 4-1: Video & Audio Settings Page

- **On Screen Display (OSD):** Display time stamp and text on the video screen.
 - OSD Text: Input text (to identify the camera) shown on the screen.
 - OSD Position: Show the OSD in either top or bottom left position on screen.
 - Display Time: When checked, time stamp will display on video screen
 - Display Text: When checked, input text will display on video screen.

- **Video Settings**

Video Settings

Primary Stream Settings

Preferred Video Codec: H264

Resolution: 1280*720 (16:9)

Bit Rate: 2048 kbps

Maximum Frame Rate: 30 fps

Bit Rate Control: CBR VBR

Image Quality: Very High

I-frame Interval: 30 Frame(1-100)

Secondary Stream Settings

Preferred Video Codec: H264

Resolution: 320*240 (4:3)

Bit Rate: 256 kbps

Maximum Frame Rate: 30 fps

Bit Rate Control: CBR VBR

I-frame Interval: 30 Frame(1-100)

Figure 4-2: Video & Audio Settings Page

- **Primary Stream Settings:**
 - Preferred Video Codec: MJPEG and H.264 supported, H.264 recommended.
 - Resolution: The video resolution in pixels used in video of camera
 - Bit Rate: Video bit rate used
 - Maximum Frame Rate: Maximum frame rate used. More data if big frame used
 - Bit Rate Control: Constantly bit rate, or variable bit rate
 - Image Quality: Image quality selection when Variable Bit Rate used
 - I-frame Interval: I-frame interval
- **Secondary Stream Settings:** Pull down to select, same as Primary steam.

- **Audio Settings:** Pull down to select Audio Codec: PCMU, PCMA, AAC supported.
Audio can also be disabled via choice.
 - Microphone Volume: Slide to adjust microphone gain.
 - Speaker Volume: Slide to adjust the speaker volume connected.

- **Power Frequency:** Select correct local power frequency to avoid video flicking effect under fluorescence light condition. Default is Outdoor.

NOTE:

- *H.264 suggested if camera needs to be viewed via Internet.*
- *If MJPEG selected, reduce max. frame rate to min. value to save bandwidth and get better image*
- Grandstream IP Camera provides two video streams, user can use them with flexibility. For example, the high-resolution stream for local recording; another low or high resolution for remote monitoring; or vice versa depending application scenarios.
- *Use below link to calculate bandwidth and storage before installation*
<http://www.grandstream.com/support/tools/bandwidth-storage-calc>

CMOS Settings Page

This page allows user to adjust the CMOS parameters:

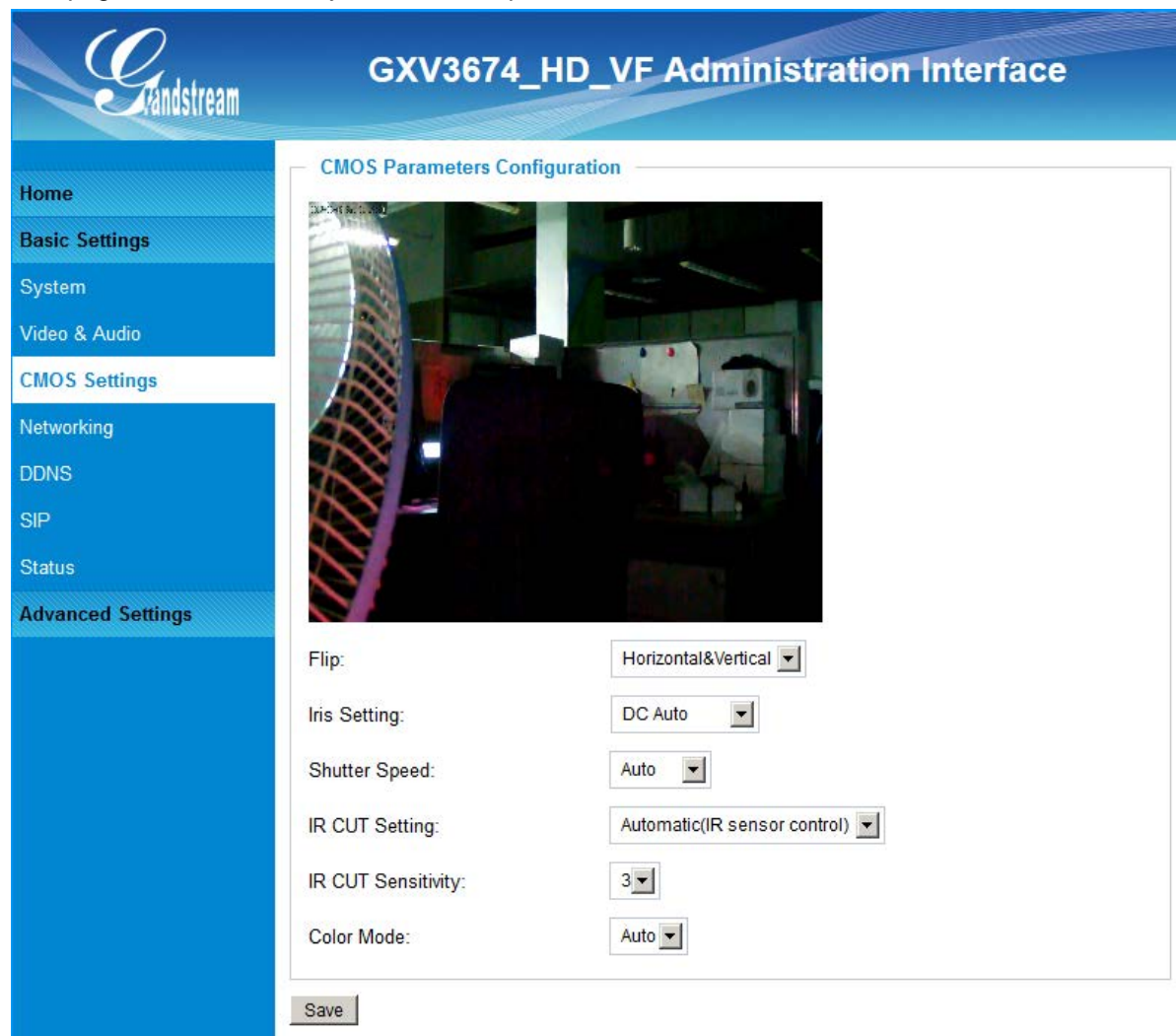

Figure 5: CMOS Settings Page

- **Flip:** Pull down to choose video flip, either vertical or horizontal or both.
- **Iris Setting:** Pull down to choose: Mechanical Manual, DC Auto, and DC Manual. Default Auto.
- **Shutter Speed:** Camera Shutter Speed. There are 10 options, with Auto, 1/30, 1/60, 1/125, 1/250, 1/500, 1/1000, 1/2000, 1/5000 and 1/10000. Default Auto.
- **IR CUT Setting:** Manual or Automatic (IR sensor controlled mechanically switching)
- **IR CUT Sensitivity:** Sensitivity for IR CUT triggered, total five levers, from lever 1 to 5.
- **Color Mode:** Camera Color Mode. There are three options: Color, Black/White, Auto (Default).

NOTE:

- *Auto option recommended for Iris Setting, Shutter Speed, IR CUT Setting and Color Mode.*

Networking Setting Page

This page allows user to configure network related parameters:

IP Address Configuration

Dynamically Assigned via DHCP

Statically Configured as:

IP Address:

Subnet Mask:

Default Gateway:

DNS Configuration

Obtain DNS Server Address Automatically

Use the Following DNS Server Address:

Primary DNS Server:

Secondary DNS Server:

HTTP

HTTP Port:

Figure 6: Networking Setting Page

- **IP Address Configuration:** Camera IP address configuration
 - Dynamically Associated via DHCP: Default setting, DHCP server assign IP to camera.
 - Statically Configured as: Static IP address configuration
- **DNS Configuration:** DNS server IP, must be configured correctly if using static IP.
- **HTTP:** Web access TCP port, default 80.

NOTE:

- *If camera behind SOHO router with port forwarding configuration for remote access, static IP or static DHCP has to be used to avoid IP address change after router reboot.*
- *TCP port above 5000 suggested if port forwarding HTTP remote access, due to some ISP would block port 80 inbound traffic. For example, change the default HTTP port from 80 to 8088, to make sure the port forwarding not likely be blocked.*
- *In addition to HTTP port, RTSP port also required to be configured for port forwarding, in order for remote party viewing the H.264 video.*
- *If change the default port from TCP 80 to port “A”, then RTSP port should be “2000+A”. Both TCP port “A” and “2000+A” should be configured for port forwarding in the router. For example, the HTTP port changed to 8088, the RTSP port should be 10088, both 8088 and 10088 should be configured for port forwarding in order for remote camera video access.*

DDNS Settings Page

This page allows user to configure dynamic DNS related parameters:

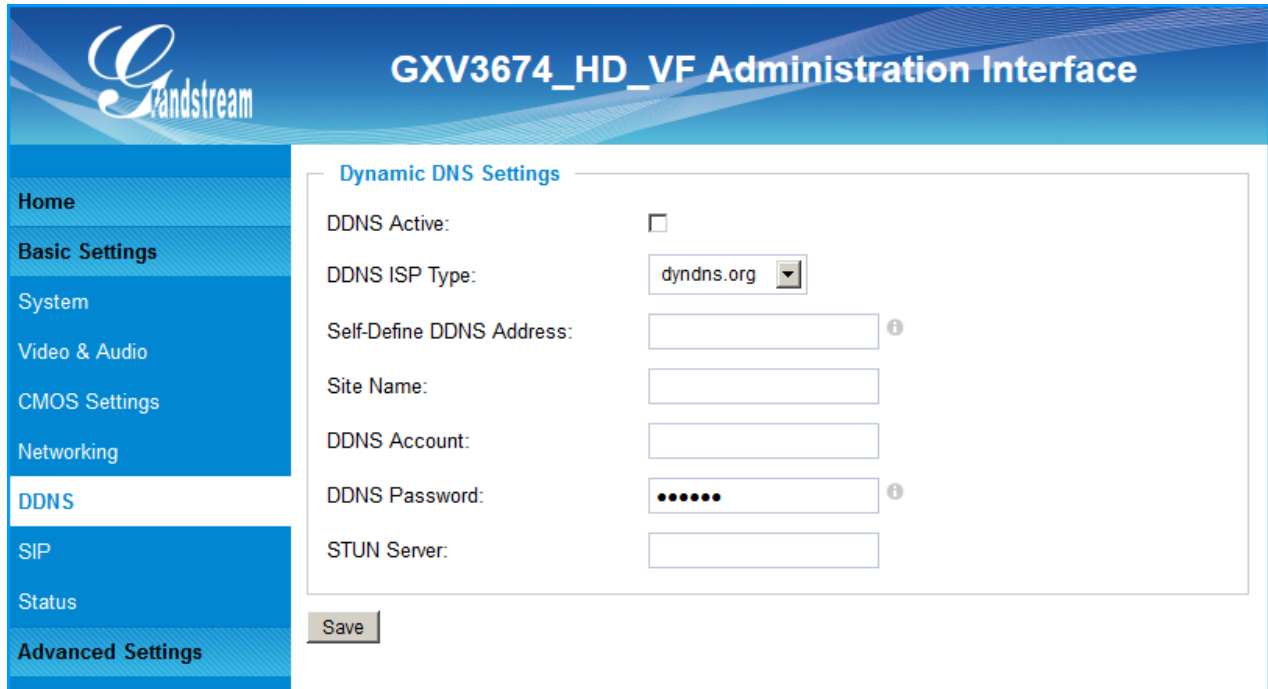

Figure 7: DDNS Setting Page

- **DDNS Active:** Enable DDNS by check this field.
- **DDNS ISP Type:** Select the DDNS service provider from the pull-down menu list
- **Self-Define DDNS Address:** Input the self-defined DDNS address
- **Site Name:** DDNS site name
- **DDNS Account:** DDNS account name
- **DDNS Password:** DDNS password
- **STUN Server:** Stun server FQDN or IP. If device behind a non-symmetric router, STUN server can help to penetrate & resolve NAT issue.

SIP Setting Page

This page allows user to configure SIP related parameters.

GXV3674_HD/FHD_VF can be configured as SIP endpoint to call out when alarm triggered, or allow permitted number to call in to check the audio/video if Grandstream IP videophone used.

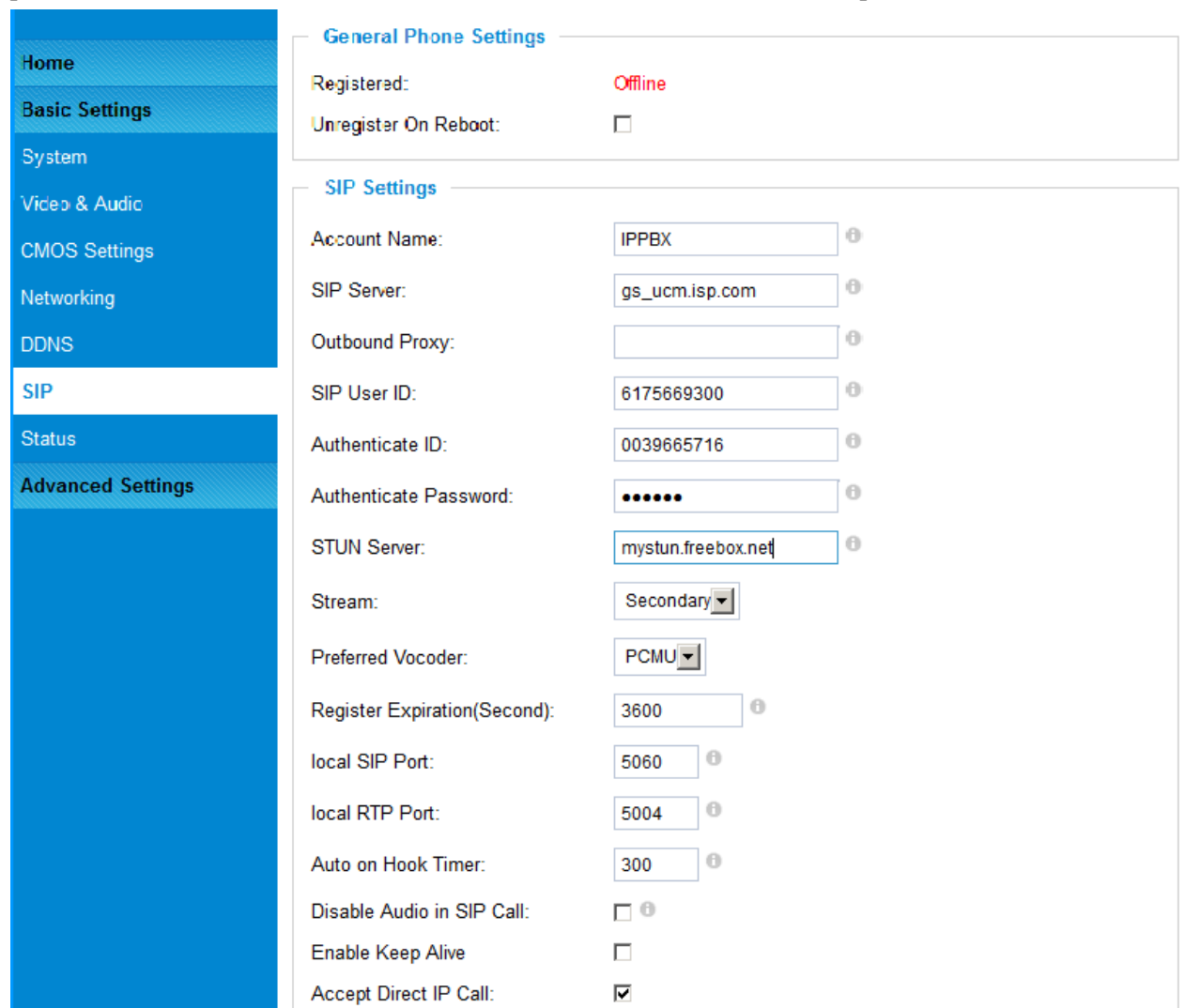
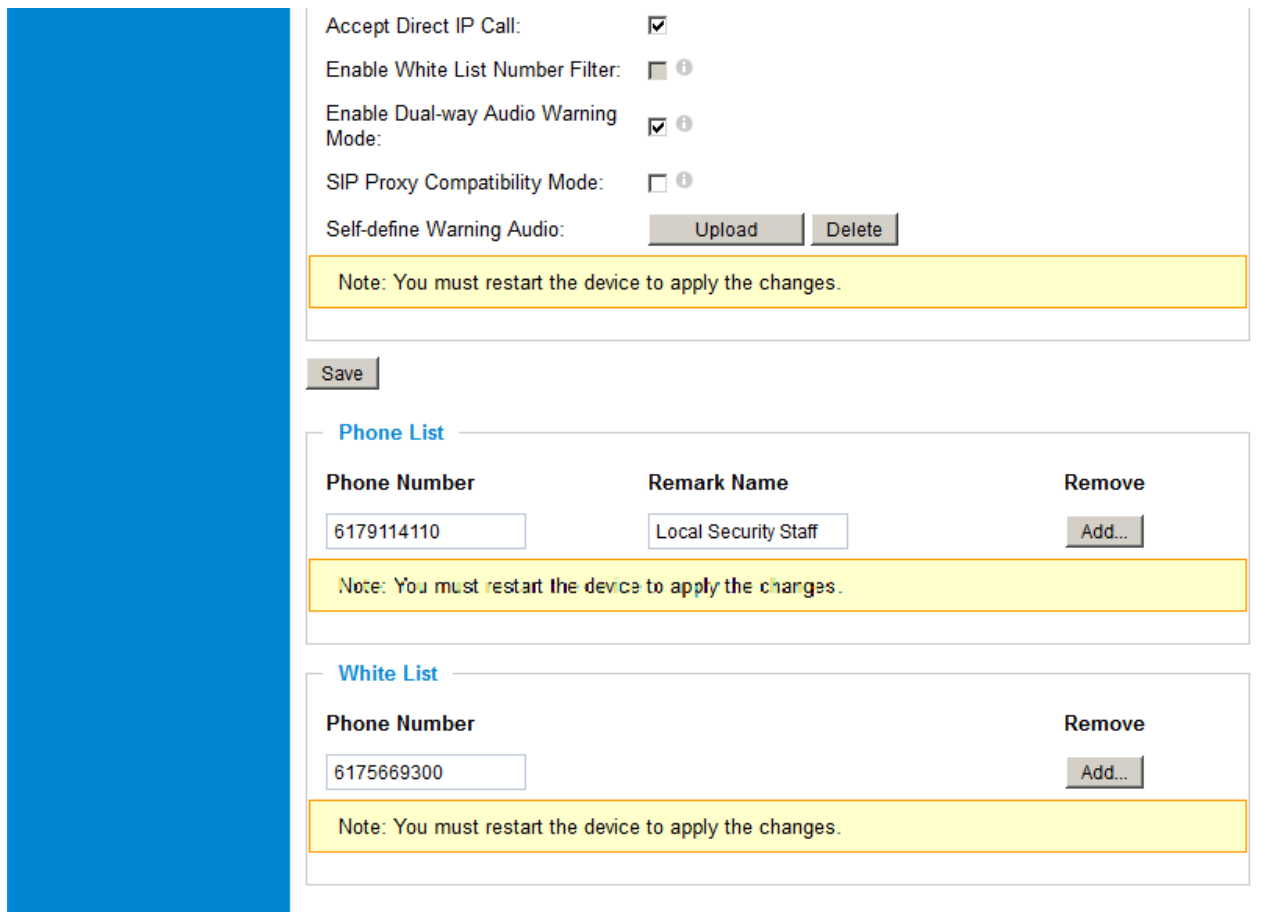

Figure 8-1: SIP Setting Page

- **Registered:** SIP registration status. Display “Online” in Green, “Offline” in Red.
- **Unregistered on Reboot:** If checked and server support, reboot camera will unbind all registration in same SIP account.
- **Account Name:** SIP account name
- **SIP Server:** FQDN or IP of SIP server from VoIP service provider
- **Outbound Proxy:** IP or FQDN of Outbound proxy server, helps penetrate NAT/Firewall
- **SIP User ID:** SIP username, or telephone number from ITSP
- **Authenticate ID:** Authenticate ID used by SIP proxy
- **Authenticate Password:** Authenticate password used by SIP proxy
- **STUN Server:** STUN server used to resolve NAT if have

- **Stream:** Which stream used for SIP call.
- **Preferred Vocoder:** Audio codec used for SIP call **(NOTE)**
- **Registration Expiration:** Registration expiration time, default 3600 seconds
- **Local SIP Port:** Local SIP port, default 5060
- **Local RTP Port:** Local RTP port for media, default 5004
- **Auto on hook Timer:** Auto On Hook timer, default 300 seconds
- **Disable Audio in SIP Call:** Checked to disable audio for SIP call
- **Enable Keep Alive:** Checked to enable, help NAT resolution
- **Accept Direct IP Call:** Check to accept peer-to-peer IP call.



The screenshot shows the SIP Setting Page with the following configuration options:

- Accept Direct IP Call:
- Enable White List Number Filter:
- Enable Dual-way Audio Warning Mode:
- SIP Proxy Compatibility Mode:
- Self-define Warning Audio: Upload Delete

Note: You must restart the device to apply the changes.

Save

Phone List

Phone Number	Remark Name	Remove
6179114110	Local Security Staff	Add...

Note: You must restart the device to apply the changes.

White List

Phone Number	Remove
6175669300	Add...

Note: You must restart the device to apply the changes.

Figure 8-2: SIP Setting Page

- **Enable White List Number Filter:** Check to allow only white list number to call in, for security
- **Enable Dual-way Audio Warning:** Check to enable two-way audio when call established (Default)
- **SIP Proxy Compatibility Mode:** Check to enable more proxy compatibility with cost of bandwidth
- **Self-define Warning Audio:** Upload self-defined warning message audio (follow the format)
- **Phone List (Phone Number):** Callee or call receiver's number when alarm call triggered.
- **White List (Phone Number):** Phone numbers allowed calling into the camera.

Status Page

This page shows the GXV3674_HD/FHD_VF operation status:

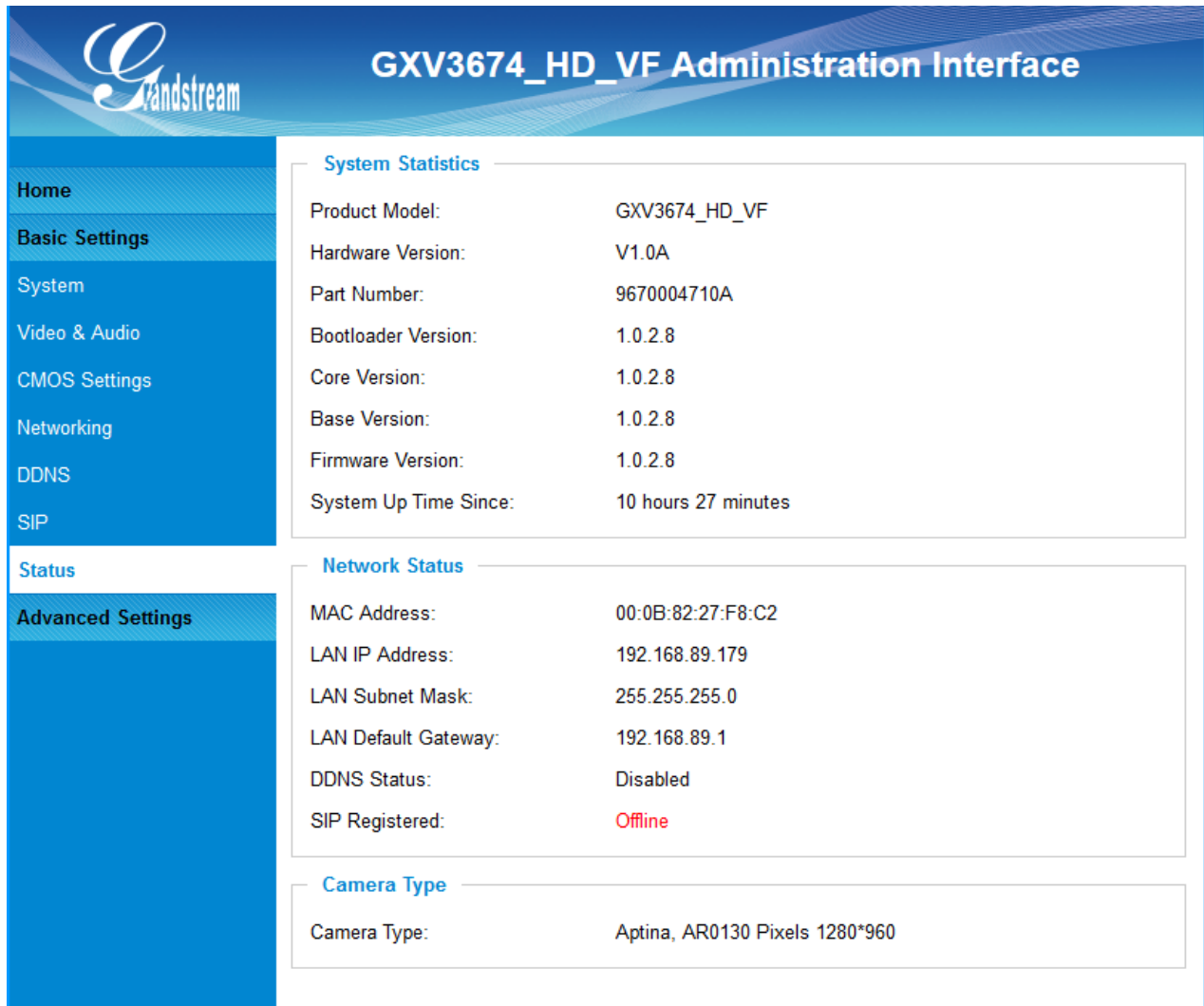

The screenshot shows the 'GXV3674_HD_VF Administration Interface' with a left-hand navigation menu and three main status sections: System Statistics, Network Status, and Camera Type.

System Statistics	
Product Model:	GXV3674_HD_VF
Hardware Version:	V1.0A
Part Number:	9670004710A
Bootloader Version:	1.0.2.8
Core Version:	1.0.2.8
Base Version:	1.0.2.8
Firmware Version:	1.0.2.8
System Up Time Since:	10 hours 27 minutes

Network Status	
MAC Address:	00:0B:82:27:F8:C2
LAN IP Address:	192.168.89.179
LAN Subnet Mask:	255.255.255.0
LAN Default Gateway:	192.168.89.1
DDNS Status:	Disabled
SIP Registered:	Offline

Camera Type	
Camera Type:	Aptina, AR0130 Pixels 1280*960

Figure 9: Status Page

NOTE:

- When SIP account registered, the status will display “Online” in Green.
- When SIP account unregistered, the status will display “Offline” in Red, as below.

SIP Registered: Offline

ADVANCED SETTINGS EXPLANATION

The supports all the traditional and advanced telephony features.

User Management Page

This page allows user to do user management:

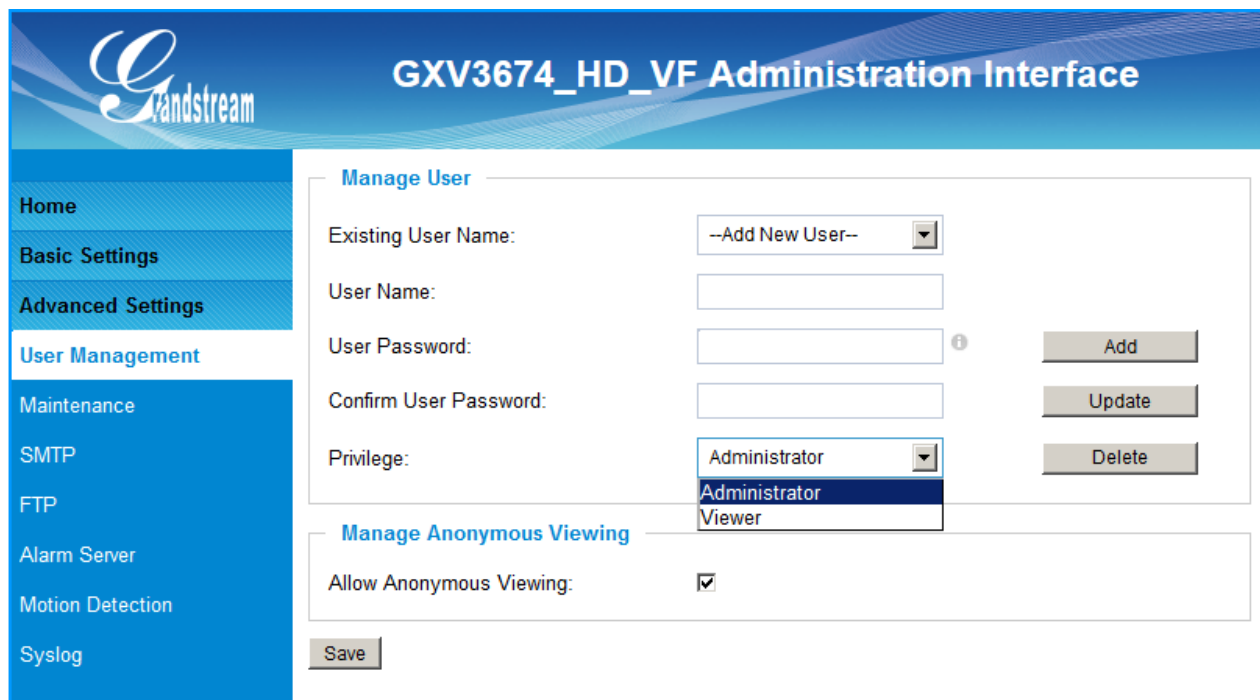

The screenshot shows the 'GXV3674_HD_VF Administration Interface' with a sidebar menu on the left containing: Home, Basic Settings, Advanced Settings, User Management (highlighted), Maintenance, SMTP, FTP, Alarm Server, Motion Detection, and Syslog. The main content area is titled 'Manage User' and includes the following fields and controls:

- Existing User Name: A dropdown menu with the option '--Add New User--'.
- User Name: A text input field.
- User Password: A text input field with an information icon (i).
- Confirm User Password: A text input field.
- Privilege: A dropdown menu with options 'Administrator', 'Administrator', and 'Viewer'.
- Buttons: 'Add', 'Update', and 'Delete' buttons are positioned to the right of the input fields.

Below the 'Manage User' section is the 'Manage Anonymous Viewing' section, which includes a checkbox for 'Allow Anonymous Viewing' that is currently checked, and a 'Save' button at the bottom.

Figure 10: User Management Page

- **Existing User Name:** Allow revise existing user or add new user
- **User Name:** The name of user need to be revised
- **User Password:** New password if revise password
- **Confirm User Password:** Re-enter the new password for verification
- **Privilege:** Choose user privilege
- **Allow Anonymous Viewing:** When checked, no security enhanced. Any person can view the camera if knowing the IP or FQDN of the camera, but can NOT change anything, just view ONLY.

Maintenance Page

This page allows user to maintain the camera:



The screenshot shows the 'Maintenance' page of the GXV3674_HD_VF Administration Interface. The page has a blue header with the Grandstream logo and the title 'GXV3674_HD_VF Administration Interface'. On the left is a navigation menu with options: Home, Basic Settings, Advanced Settings, User Management, Maintenance (highlighted), SMTP, FTP, Alarm Server, Motion Detection, and Syslog. The main content area is divided into three sections:

- Restart the device:** A text box containing 'Restart the device.' and a 'Restart' button.
- Restore the device:** A text box containing 'Reset settings, except IP address, to factory default.' and a 'Restore' button.
- Firmware Upgrade and Provisioning:** A section with several input fields:
 - 'Upgrade via:' with a dropdown menu set to 'HTTP'.
 - 'Firmware Server Path:' with a text box containing 'firmware.grandstream.com'.
 - 'Config Server Path:' with a text box containing 'config.grandstream.com'.
 - 'XML Config File Password:' with a masked password field (six dots) and an information icon.
 - 'Automatic Upgrade Interval(Minutes):' with a text box containing '10080'.
 - 'Automatic Upgrade:' with a checked checkbox.

A 'Save' button is located at the bottom of the 'Firmware Upgrade and Provisioning' section.

Figure 11: Maintenance Page

- **Restart:** When clicked, the camera will reboot or restart
- **Restore:** When clicked, the camera will be reset to factory default, wiping out all the configurations (except IP address)

Firmware Upgrade and Provisioning:

- **Upgrade via:** Upgrade firmware via TFTP, HTTP or HTTPS
- **Firmware Server Path:** Server path holding the firmware
- **Config Server Path:** Server path holding the configuration file (auto provisioning)
- **XML ConfigFile Password:** Password for encrypt the XML based configuration file
- **Automatic Upgrade Interval (Minutes):** Time interval for automatic upgrade, default 10080
- **Automatic Upgrade:** Checked to enable automatic firmware upgrade and provisioning.

NOTE:

- Only XML based automatic provisioning is supported by GXV3674_HD/FHD_VF.

SMTP Setting Page (Email Alarm)

This page allows user to configure email client to send out email when alarm triggered:

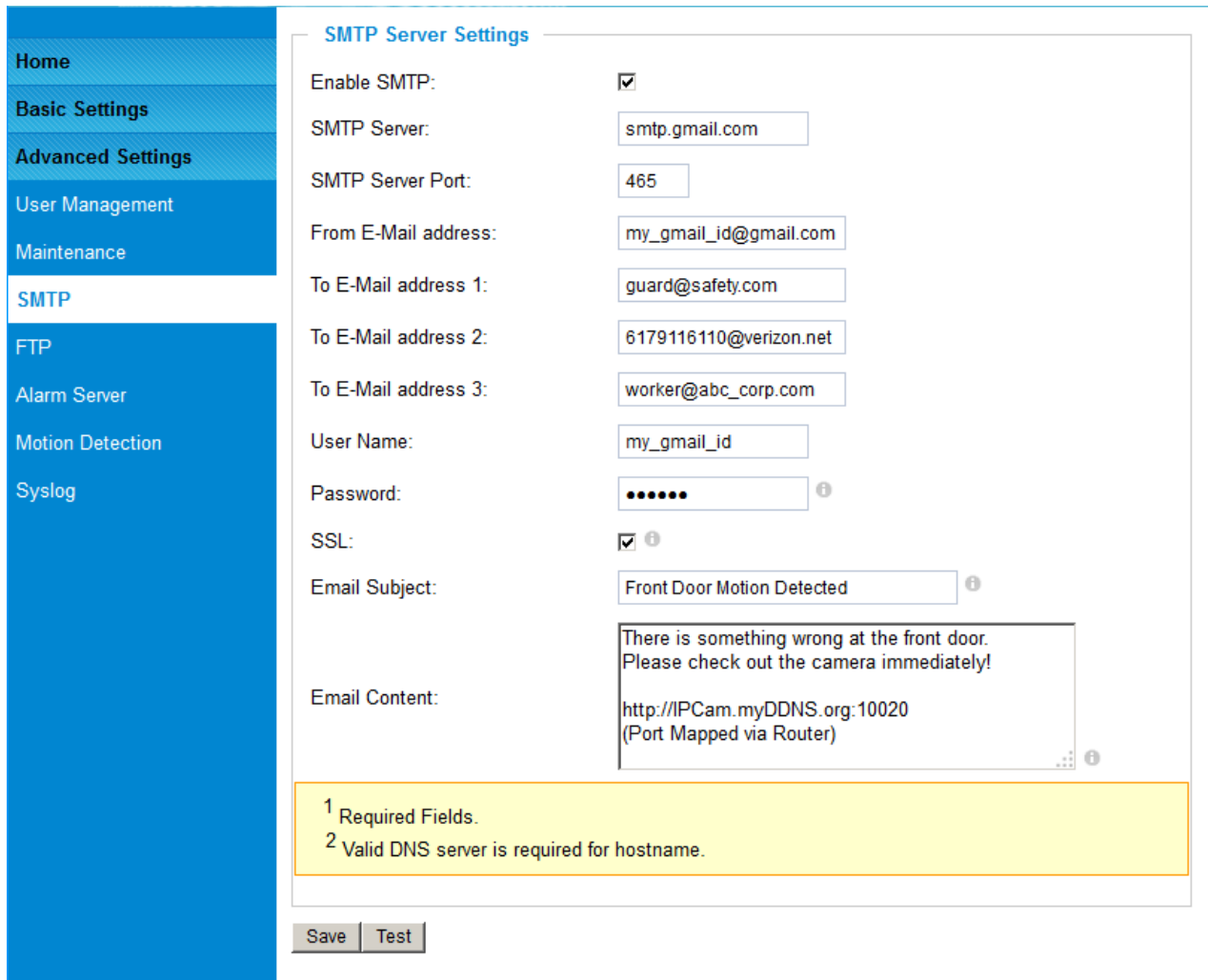
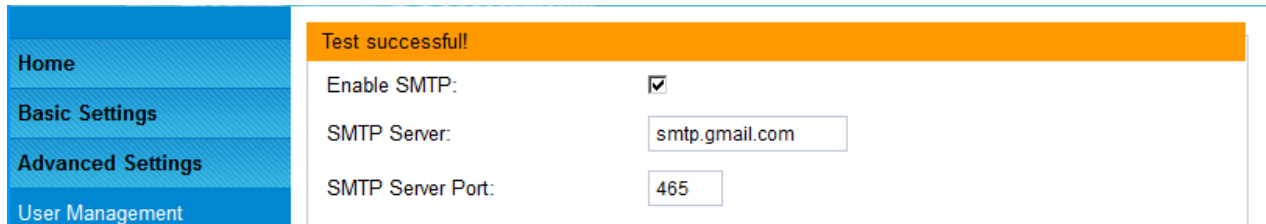

Figure 12: SMTP Setting Page

- **Enable SMTP:** When checked, email client is enabled.
- **SMTP Server:** SMTP Email Server IP or Domain Name
- **SMTP Server Port:** Port number used by server to send email
- **From Email address:** The email address of alarm email sending from, usually client email ID
- **To E-Mail address:** The email address to receive the alarmed email, total 3 included.
- **User Name:** Email client User ID
- **Password:** Email client password
- **SSL:** Check if the SMTP email server requires SSL
- **Email Subject:** Customizable email subject for user convenience
- **Email Content:** Customizable email body for user convenience

NOTE:

- Click “Save” to save the email configuration information.
- Click “Test” after configuration, if setting is correct, a test email will send out and “Test successful!” orange bar will display like below



Home	Test successful!	
Basic Settings	Enable SMTP:	<input checked="" type="checkbox"/>
Advanced Settings	SMTP Server:	<input type="text" value="smtp.gmail.com"/>
User Management	SMTP Server Port:	<input type="text" value="465"/>

FTP Settings Page (Upload Alarm)

This page allows user to configure FTP parameters to upload the alarm or video recording::

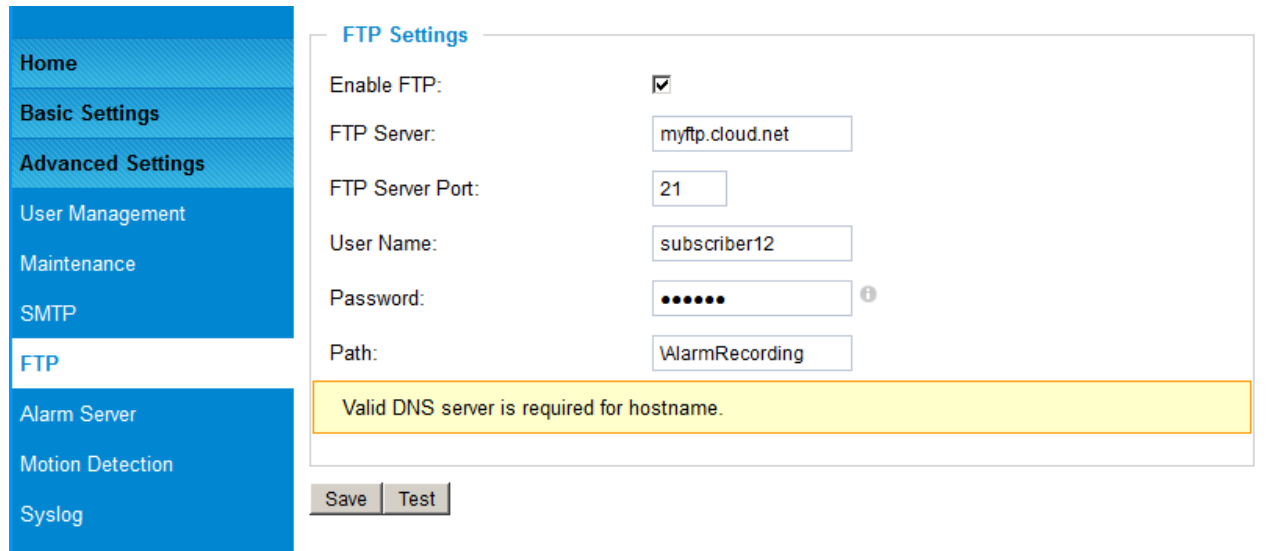

Figure 13: FTP Setting Page

- **Enable FTP:** When checked, built-in FTP client is enabled.
- **FTP Server:** IP or Domain name of FTP site or server
- **FTP Server Port:** TCP port for FTP server, default port number 21
- **User Name:** FTP server User ID
- **Password:** FTP server user password
- **Path:** Path in the server where upload files are stored.

NOTE:

- Click “Save” to save the FTP configuration information.
- Click “Test” after configuration, if setting is correct, a test FTP operation will be performed and “Test successful!” orange bar will display if the operation is successful.

Alarm Server Settings Page (Upload Alarm to supported VMS or HTTP Server)

This page allows user to configure alarm HTTP server to upload alarms:

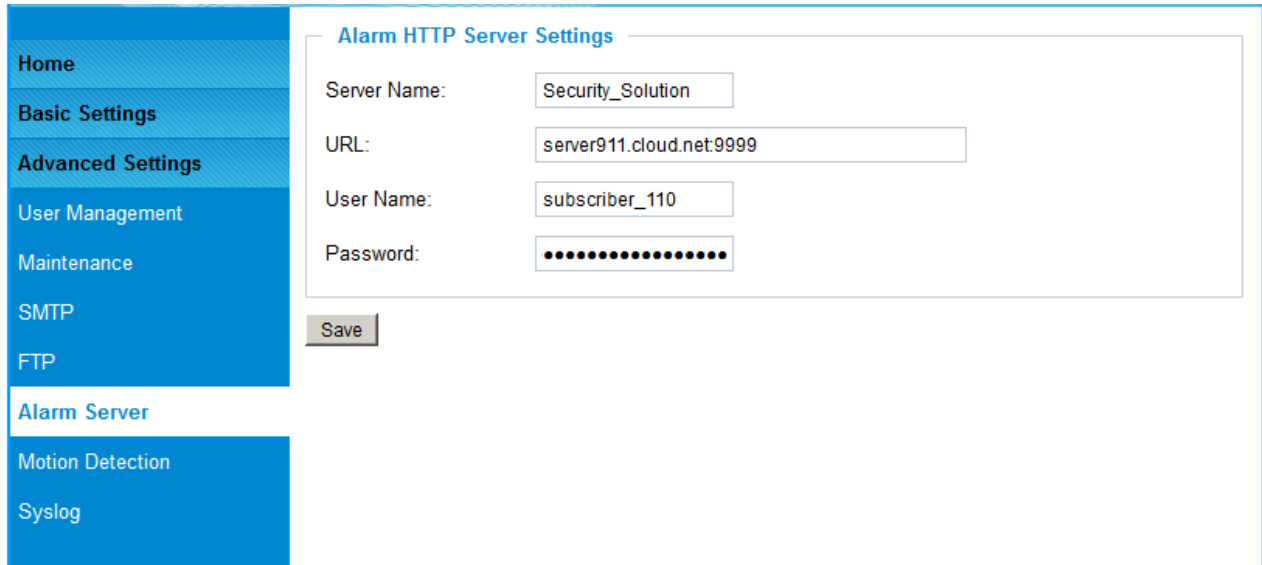

Figure 14: Alarm HTTP Server Setting Page

- **Server Name:** The name of HTTP server or VMS system
- **URL:** URL of the Server
- **User Name:** User ID from that Server
- **Password:** Password for that User ID

NOTE:

- Grandstream provide HTTP API to help third party companies by using HTTP server or VMS to develop further solutions for their customers.
http://www.grandstream.com/products/surveillance/general/documents/grandstream_http_api.pdf
- Grandstream IP Camera and Encoder (include GXV3674_HD/FHD_VF) are ONVIF certified.

Motion Detection Configuration Page (Set Alarm)

This page allows user to configure motion detection to trigger alarms:

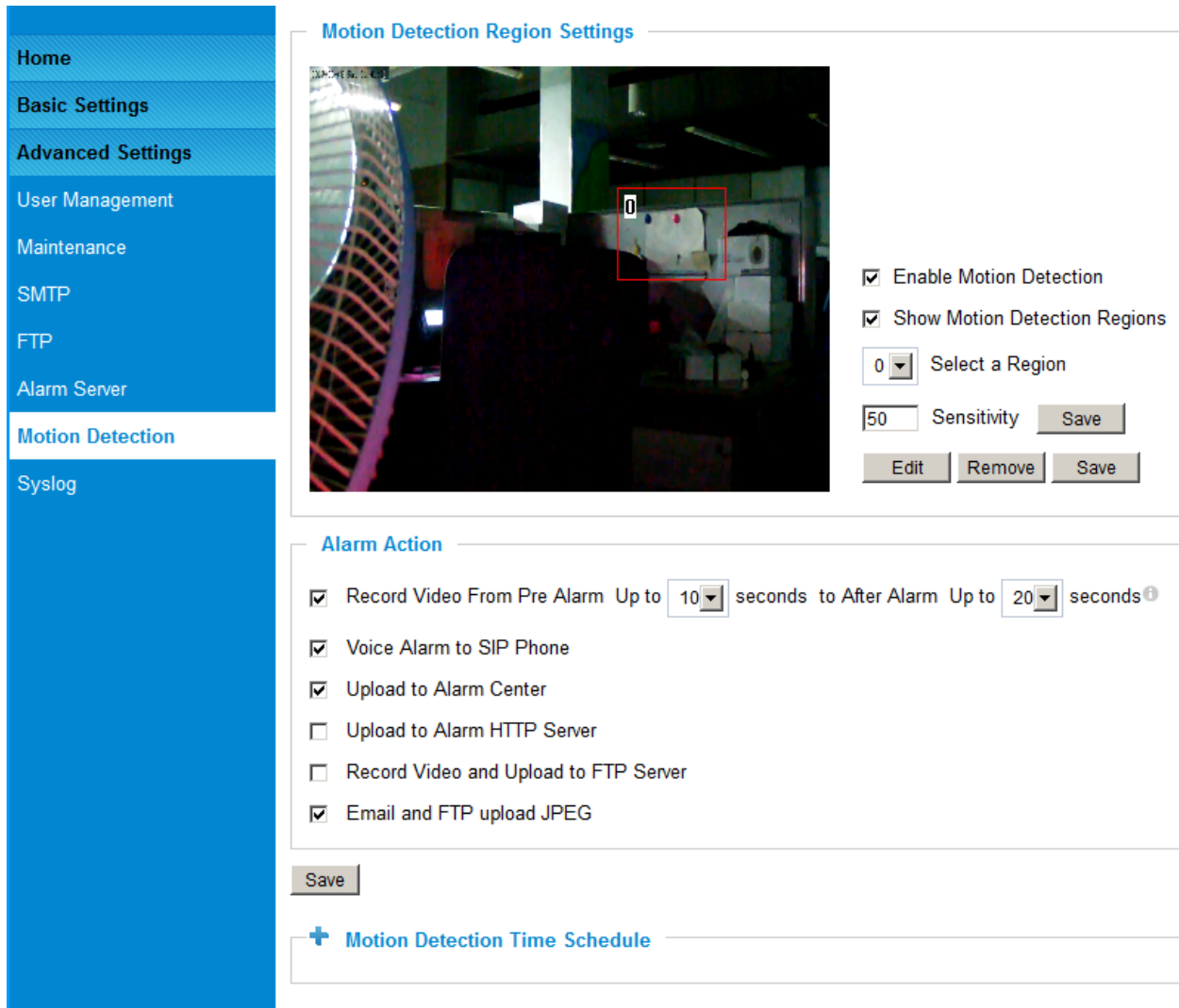

The screenshot displays the 'Motion Detection Configuration Page (Set Alarm)'. On the left is a blue navigation sidebar with the following menu items: Home, Basic Settings, Advanced Settings, User Management, Maintenance, SMTP, FTP, Alarm Server, Motion Detection (highlighted), and Syslog. The main content area is titled 'Motion Detection Region Settings' and features a video feed of a room with a white rectangular region of interest (ROI) labeled '0'. To the right of the video are the following controls:

- Enable Motion Detection
- Show Motion Detection Regions
- 0 Select a Region (dropdown menu)
- 50 Sensitivity (input field) [Save]
- [Edit] [Remove] [Save] (buttons)

Below this section is the 'Alarm Action' section with the following settings:

- Record Video From Pre Alarm Up to 10 seconds to After Alarm Up to 20 seconds ⓘ
- Voice Alarm to SIP Phone
- Upload to Alarm Center
- Upload to Alarm HTTP Server
- Record Video and Upload to FTP Server
- Email and FTP upload JPEG

A [Save] button is located below the Alarm Action section. At the bottom, there is a '+ Motion Detection Time Schedule' section with an empty configuration area.

Figure 15-1: Motion Detection Configuration Page

- **Enable Motion Detection:** When checked, Motion Detection enabled.
- **Show Motion Detection Regions:** When checked, Motion Detection region with number will be displayed in White Rectangle in the screen; when “Edit” clicked, the Rectangle will become Red, as shown in Figure 16-1.
- **Select a Region:** Pull down to select and configure alarm region, altogether 16 alarm region available, from 0 to 15.
- **Sensitivity:** Select configured alarm region number, input number for sensitivity to trigger alarm, 100 is the maximum sensible value.

Alarm Action:

- **Record Video From.....:** Allow user to configure how long pre/post alarm trigger moment, the video to be captured by the camera.
- **Voice Alarm to SIP Phone:** When checked and SIP proxy configured and IPCam registered, SIP alarm call will be made to pre-configured number.
- **Upload to Alarm Center:** When checked, the alarm video will be transferred to Alarm Center, like Grandstream free GSurf_Pro VMS software.
- **Upload to Alarm HTTP Server:** When checked, the alarm will be sent to Alarm HTTP Server. Third Party Server also can be used via GS HTTP API
- **Record Video and Upload...:** When checked and FTP server configured, the recorded video will be FTPed to the configured FTP server.
- **Email and FTP upload JPEG:** When checked, snapshots of trigger moment will be generated and be emailed to pre-configured email account, also upload to FTP server if configured.

NOTE:

- Grandstream free GSurf_Pro VMS software can be downloaded here:
http://www.grandstream.com/products/tools/surveillance/gsurf_pro.zip

Motion Detection Time Schedule:

This page allows user to configure Motion Detection Operation Schedule:

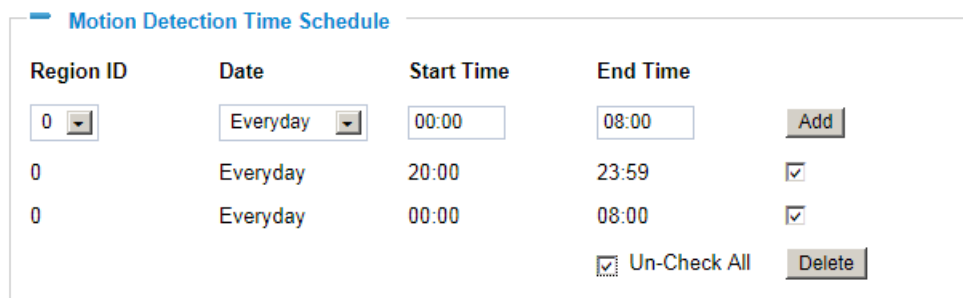

The screenshot shows a web interface titled "Motion Detection Time Schedule". It features a table with columns for Region ID, Date, Start Time, and End Time. There are two rows of data, each with a checkbox in the fifth column. Below the table are "Un-Check All" and "Delete" buttons.

Region ID	Date	Start Time	End Time	
0	Everyday	00:00	08:00	<input type="checkbox"/>
0	Everyday	20:00	23:59	<input checked="" type="checkbox"/>
0	Everyday	00:00	08:00	<input checked="" type="checkbox"/>

Un-Check All Delete

Figure 15-2: Motion Detection Schedule Configuration Page

- As shown in Figure 15-2, user can configure the Motion Detection Region with related Start and Stop time to control the motion detection operation.

Syslog Settings Page (Troubleshooting)

This page allows user to enable the Syslog to help troubleshooting problems:

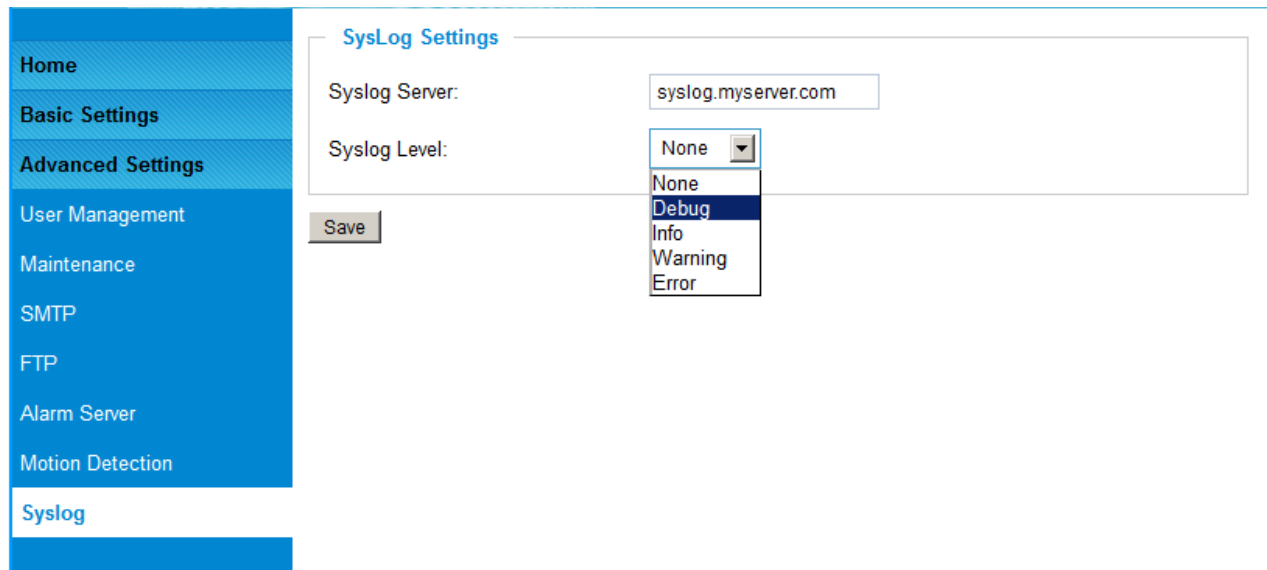

Figure 16: Alarm Server Setting Page

- **Syslog Server:** Syslog server IP or Domain Name
- **Syslog Lever:** Lever of syslog message sent to the syslog server:
None, Debug, Info, Warning, Error.

Software Upgrade

Software upgrade can be done via either TFTP, HTTP or HTTPS. The corresponding configuration settings are in the ADVANCED SETTINGS configuration page.

Software Upgrade via TFTP, HTTP or HTTPS

This page allows user to configure firmware upgrade:

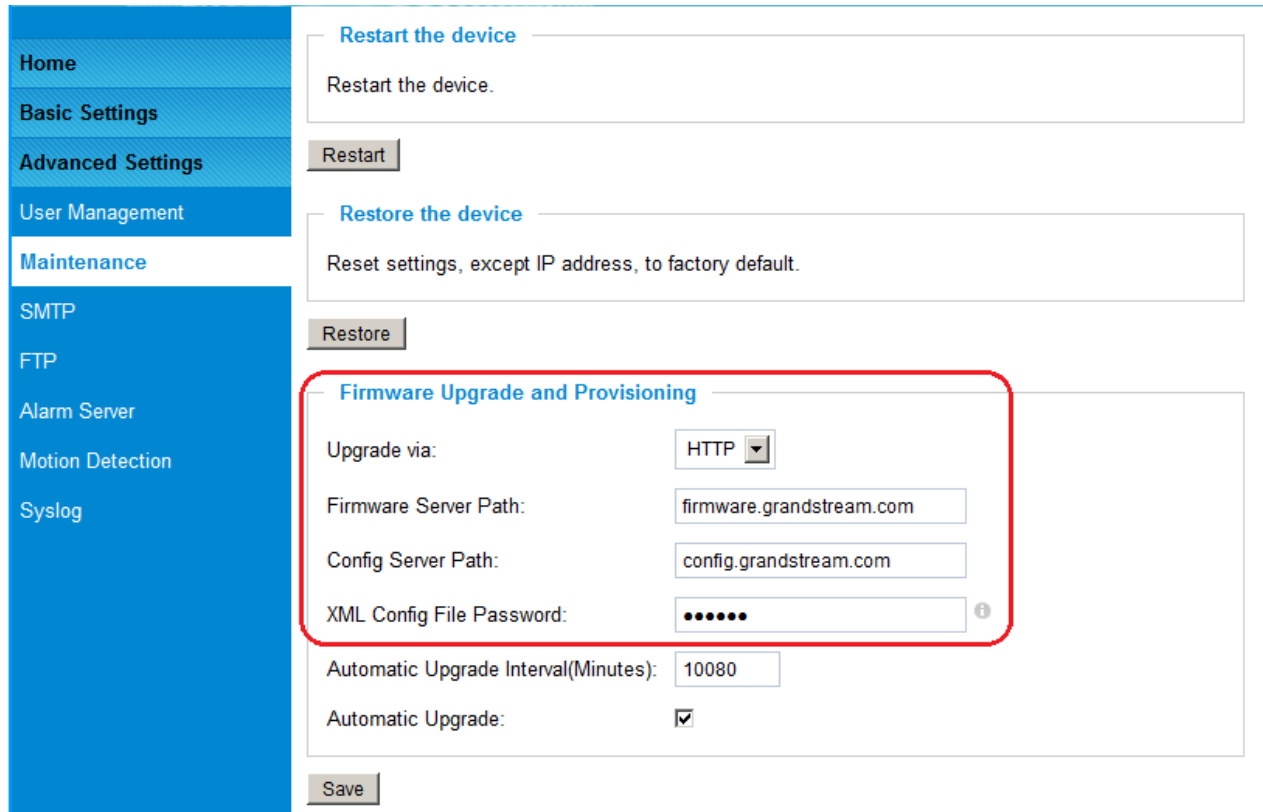

The screenshot shows the 'Firmware Upgrade and Provisioning' configuration page. The sidebar menu on the left includes: Home, Basic Settings, Advanced Settings, User Management, Maintenance, SMTP, FTP, Alarm Server, Motion Detection, and Syslog. The main content area has three sections: 'Restart the device' with a 'Restart' button, 'Restore the device' with a 'Restore' button, and 'Firmware Upgrade and Provisioning' which is highlighted with a red box. The 'Firmware Upgrade and Provisioning' section contains the following fields: 'Upgrade via:' (HTTP), 'Firmware Server Path:' (firmware.grandstream.com), 'Config Server Path:' (config.grandstream.com), 'XML Config File Password:' (masked with dots), 'Automatic Upgrade Interval (Minutes):' (10080), and 'Automatic Upgrade:' (checked). A 'Save' button is located at the bottom of the form.

Figure 17: Firmware Upgrade and Provisioning

NOTE:

- Grandstream recommends end-user use the Grandstream HTTP server.
- Currently the HTTP firmware server is firmware.grandstream.com. For large companies or user without Internet connection, we recommend maintaining their own TFTP/ HTTP/HTTPS server for upgrade and provisioning procedures.

Instructions for local firmware upgrade using TFTP server:

1. Unzip the file and put all of them under the root directory of the TFTP server.
2. Put the PC running the TFTP server and the device in the same LAN segment.
3. Please go to File -> Configure -> Security to change the TFTP server's default setting from "Receive Only" to "Transmit Only" for the firmware upgrade.
4. Start the TFTP server, in the phone's web configuration page
5. Configure the Firmware Server Path with the IP address of the PC
6. Update the change and reboot the unit

End users can also choose to download the free HTTP server from <http://httpd.apache.org/> or use Microsoft IIS web server.

Configuration File Download

Grandstream SIP Device can be configured via Web Interface as well as via Configuration File through TFTP or HTTP/HTTPS. "Config Server Path" is the TFTP or HTTP/HTTPS server path for configuration file. It needs to be set to a valid URL, either in FQDN or IP address format. The "Config Server Path" can be same or different from the "Firmware Server Path".

A configuration parameter is associated with each particular field in the web configuration page. A parameter consists of a Capital letter P and 1 to 3 (Could be extended to 4 in the future) digit numeric numbers. i.e., P2 is associated with "Admin Password" in the ADVANCED SETTINGS page. For a detailed parameter list, please refer to the corresponding firmware release configuration template.

When Grandstream Device boots up or reboots, it will issue request for configuration file named "cfgxxxxxxxxxxxx.xml", where "xxxxxxxxxxxx" is the MAC address of the device, i.e., "cfg000b820102ab.xml". The configuration file name should be in lower cases.

Currently GXV3674_HD/FHD_VF only support XML configuration.

RESTORE FACTORY DEFAULT SETTING

WARNING!

Restoring the Factory Default Setting will DELETE all configuration information of the camera. Please BACKUP or PRINT out all the settings before approach to following steps. Grandstream will not take any responsibility if you lose all the parameters of setting or cannot connect to your VoIP service provider.

FACTORY RESET

Reset from Web Interface

This page allows user to configure dynamic network related parameters:

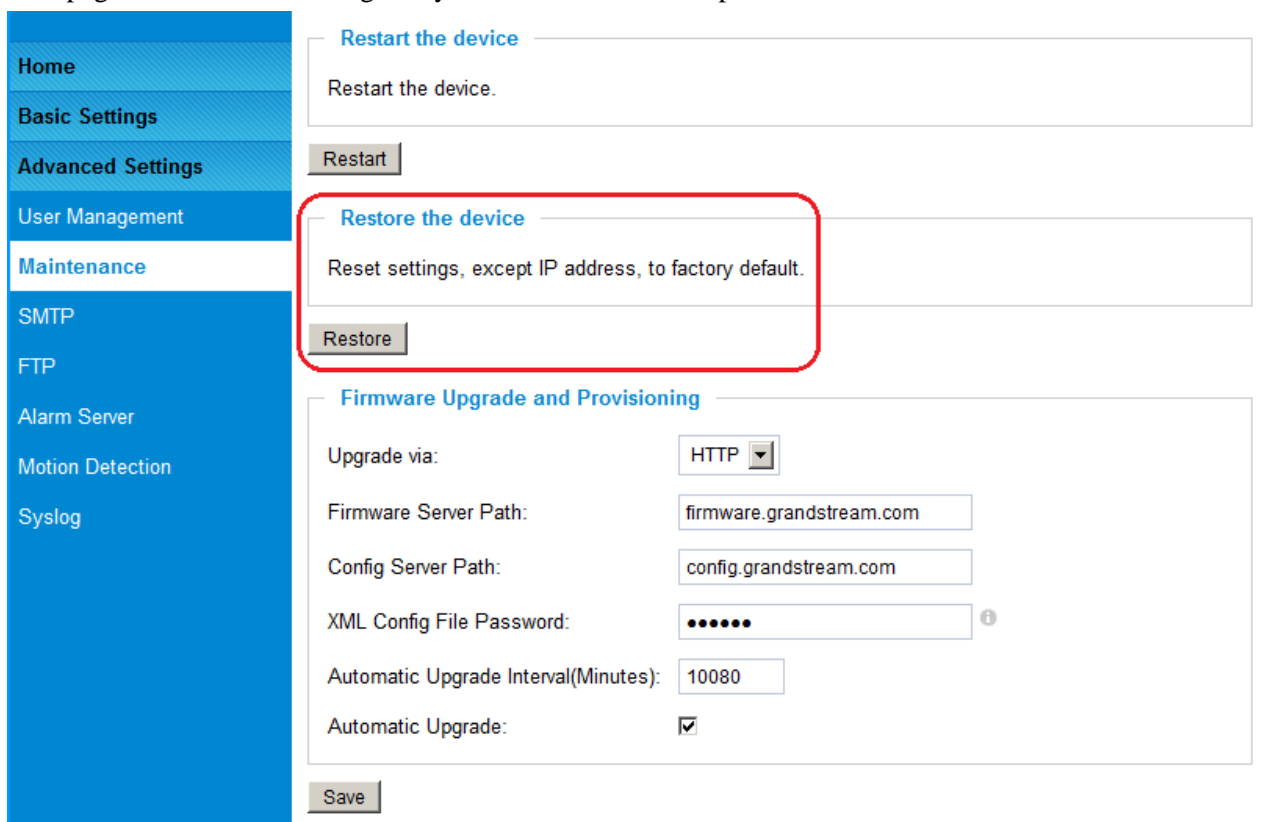

The screenshot shows the web interface with a left-hand navigation menu. The 'Maintenance' menu item is selected. The main content area is divided into three sections:

- Restart the device**: Contains the text 'Restart the device.' and a 'Restart' button.
- Restore the device**: This section is highlighted with a red box. It contains the text 'Reset settings, except IP address, to factory default.' and a 'Restore' button.
- Firmware Upgrade and Provisioning**: Contains several input fields:
 - Upgrade via: HTTP (dropdown menu)
 - Firmware Server Path: firmware.grandstream.com
 - Config Server Path: config.grandstream.com
 - XML Config File Password: [masked]
 - Automatic Upgrade Interval(Minutes): 10080
 - Automatic Upgrade:

A 'Save' button is located at the bottom of the 'Firmware Upgrade and Provisioning' section.

Figure 18: Factory Reset from Web Interface

IP SURVEILLANCE FAQ

1. What is the default IP address of the GXV3674_HD/FHD_VF?

A: The default IP configuration is DHCP.

2. Why can I not view the live video stream in Microsoft Internet Explorer?

A: Please double check whether the Grandstream Plug-in/Active-X is installed correctly. Once you log into the GXV3674_HD/FHD_VF web interface, Internet Explorer will indicate that this website wants to install the following add-on: 'GSViewer.cab' from Grandstream Networks, Inc. Please install this add-on when prompted by IE.

3. How do you manually uninstall the Grandstream video viewer add-on for IE?

Please follow these steps to uninstall the add-on:

1. Delete the *GSViewerX Control* from *C:\WINDOWS\Downloaded Program Files* directory
2. Delete *GSNetClient.dll*, *GS_Replay.exe*, *GSViewerX.ocx*, *hi_h264dec_w.dll*, *lik_VoiceEngine_dll.dll* and *GSViewerX.inf* from *C:\WINDOWS\system32*

4. Why can't I access the GXV3674_HD/FHD_VF web configuration interface?

Q 1: Is your internet service down?

A 1: Connect a PC to the internet to test the connection.

Q 2: Are the PC and the device in different subnets?

A 2: Check the subnet mask and default gateway of the device and PC.

Q 3: Is there a conflict with another IP address?

A 3: Try to change the IP address of the device.

Q 4: Has the HTTP port been changed?

A 4: Contact the administrator of the device for more information.

5. The GXV3674_HD/FHD_VF web configuration page is not displayed correctly in IE8 ?

In IE8, Compatibility View might need to be enabled for the GXV3674_HD/FHD_VF web configuration page to load properly. To enable compatibility view, open IE8, click *Tools, Compatibility View Setting*, and add the GXV3674_HD/FHD_VF web configuration pages to the Compatibility View.

6. Why does IE indicate to install Grandstream Video Viewer add-on after a firmware upgrade? The add-on was properly installed before the firmware upgrade process.

New firmware will often upgrade the add-on as well. To watch the live video stream, you must install the newest version of the add-on.

7. How do you watch secondary video stream?

Login to the home page of the GXV3674_HD/FHD_VF web GUI, click Play to watch the video stream. To watch a secondary video stream, right click on the video, and select *Secondary Stream* on the pop-up menu. Try reinstalling the Grandstream Viewer add-on for IE if you cannot see the video stream.

8. What is DDNS? Is it important for IP surveillance product to have DDNS support?

DDNS is an acronym for Dynamic Domain Name Service. It is important to choose an IP network camera that has DDNS support for dynamic IP addresses. Chances are that the network has a dynamic IP address (which changes with every log on). A DDNS service makes sure that the camera's IP address always matches up to the current server address. DDNS also allows a website to be linked to the IP camera that is constantly updated with the correct information and has a reliable feed.

9. Why is Windows Media Player unable to play the recorded video files?

The GXV3674_HD/FHD_VF uses the H.264 video codec. Windows Media Player may lack the proper H.264 decoder to play the recorded video. Please download the Microsoft FFDSHOW H.264 decoder from <http://sourceforge.net/projects/ffdshow-tryout/> and install it.

10. Alarm Triggered Events do not work with GSurf_Pro?

Please double check the Alarm Action on your GXV3674_HD/FHD_VF. Login to the web GUI of the GXV3674_HD/FHD_VF, go to the Motion Detection or Alarm Events page, and make sure option Upload to Alarm Center is checked.

11. Recommended to save the video files in different directories when using GSurf_Pro?

It is better to save video files in different directory to prevent accidental deletion of the recorded files you need.

12. How to use a cell phone to watch the GXV3674_HD/FHD_VF video stream?

You must set the video resolution to QCIF to watch the GXV3674_HD/FHD_VF video stream from a cell phone. Make sure to set the bit rate to 64kbps to ensure the best video quality.

13. What Smartphone application should I use to view the video?

There are free application and paid version application for this, like: IP Cam Viewer

<http://hit-mob.com/>

14. Why the IP address of the device NOT reset when clicking the “Restore” button?

The GXV3674_HD/FHD_VF could be installed in areas that are not easy to access. For example, it could be installed on the roof of a building or the ceiling of an office. This makes it difficult to reinstall the device, therefore the “Restore” function will not clear the IP address.

15. Why can't the live video stream be viewed using a mobile phone or GSurf_Pro after changing the HTTP Port of the device?

Make sure that the RTSP port of the device is set to 2000 plus the HTTP Port number. For example, if the HTTP port is 88, then the RTSP port of the device that you configured on GSurf_Pro or mobile phone should be 2088.

16. Port forwarding

Two ports must be forwarded on your router to watch video from a GXV3674_HD/FHD_VF that is located on a private network from a PC in a public network. The web port (HTTP) and the RTSP port. Please make note that the RTSP port number changes according to the web port. If the web port is 80, then the RTSP port is 554. If the web port is not 80, then the RTSP port equals the web port +2000. For example, if the web port is 88, then the RTSP port will be 2088.

17. Tested PC display adapters.

Display Adapter	Test Result
SiS 650/651/740/661 FX/741/760 Series	Works normally
Intel® 82945R Express Chipset Family	Works normally

VIA/S3G UniChrome Pro IGP	Works normally
NVIDIA Geforce 7300GS	Works normally
SiS 661FX	Works normally
SiS Mirage Graphics	Works normally
SiS 661 Series	Works normally
Intel® G33/G31 Express	Works normally
SiS Mirage3 Graphics	Works normally
SiS 661FX/GX Mirage Graphics	Works normally
S3 Graphics ProSavageDDR(Microsoft Corporation)	Works normally
XGI Velari Z7/Z9/Z9S V1.08.12	There is some delay when playing videos.
Intel® 965 Express Chipset Family	Works normally
ATI Mobility Radeon X1300	Works normally
Intel® G45/G43 Express Chipset	Works normally
Mobile Intel 965 Express Chipset Family	Works normally
Mobile Intel® 4 Series Express Chipset Family	Works normally
Mobile Intel® 945GM Express Chipset Family	Works normally
Mobile intel® 915GM/GMS, 910GML Express Chipset Family	Works normally
Intel® G45/G43 Express Chipset	Works normally
ATI Technologies, RAGE XL PCI	This display adapter cannot display videos.