



Push-to-Talk V2 Speaker Operations Guide

Part #011180, RAL 9002, Gray White, Standard
Part #011181, RAL 9003, Signal White, Optional

Document Part #930468C
for Firmware Version 6.4.0

CyberData Corporation
3 Justin Court
Monterey, CA 93940
(831) 373-2601

Push-to-Talk V2 Speaker Operations Guide 930468C
Part # 011180
Part # 011181

COPYRIGHT NOTICE:

© 2014, CyberData Corporation, ALL RIGHTS RESERVED.

This manual and related materials are the copyrighted property of CyberData Corporation. No part of this manual or related materials may be reproduced or transmitted, in any form or by any means (except for internal use by licensed customers), without prior express written permission of CyberData Corporation. This manual, and the products, software, firmware, and/or hardware described in this manual are the property of CyberData Corporation, provided under the terms of an agreement between CyberData Corporation and recipient of this manual, and their use is subject to that agreement and its terms.

DISCLAIMER: Except as expressly and specifically stated in a written agreement executed by CyberData Corporation, CyberData Corporation makes no representation or warranty, express or implied, including any warranty or merchantability or fitness for any purpose, with respect to this manual or the products, software, firmware, and/or hardware described herein, and CyberData Corporation assumes no liability for damages or claims resulting from any use of this manual or such products, software, firmware, and/or hardware. CyberData Corporation reserves the right to make changes, without notice, to this manual and to any such product, software, firmware, and/or hardware.

OPEN SOURCE STATEMENT: Certain software components included in CyberData products are subject to the GNU General Public License (GPL) and Lesser GNU General Public License (LGPL) "open source" or "free software" licenses. Some of this Open Source Software may be owned by third parties. Open Source Software is not subject to the terms and conditions of the CyberData COPYRIGHT NOTICE or software licenses. Your right to copy, modify, and distribute any Open Source Software is determined by the terms of the GPL, LGPL, or third party, according to who licenses that software.

Software or firmware developed by CyberData that is unrelated to Open Source Software is copyrighted by CyberData, subject to the terms of CyberData licenses, and may not be copied, modified, reverse-engineered, or otherwise altered without explicit written permission from CyberData Corporation.

TRADEMARK NOTICE: CyberData Corporation and the CyberData Corporation logos are trademarks of CyberData Corporation. Other product names, trademarks, and service marks may be the trademarks or registered trademarks of their respective owners.



Technical Support

The fastest way to get technical support for your VoIP product is to submit a VoIP Technical Support form at the following website:
<http://www.cyberdata.net/support/contactsupportvoip.html>

Phone: (831) 373-2601, Ext. 333

Email: support@cyberdata.net

Fax: (831) 373-4193

Company and product information is at www.cyberdata.net.



Revision Information

Revision 930468C, which corresponds to firmware version 6.4.0, was released on April 4, 2014.

- Adds the following warning to the following sections:
 - [Important Safety Instructions](#)
 - [Section 1.2, "Installation"](#)
 - [Section Appendix A; "Mounting the Speaker"](#)

Warning Text: "The PoE connector is intended for intra-building connections only and does not route to the outside plant."

Pictorial Alert Icons

 <p>GENERAL ALERT</p>	<p>General Alert</p> <p><i>This pictorial alert indicates a potentially hazardous situation. This alert will be followed by a hazard level heading and more specific information about the hazard.</i></p>
	<p>Ground</p> <p><i>This pictorial alert indicates the Earth grounding connection point.</i></p>

Hazard Levels

Danger: Indicates an imminently hazardous situation which, if not avoided, will result in death or serious injury. This is limited to the most extreme situations.

Warning: Indicates a potentially hazardous situation which, if not avoided, could result in death or serious injury.

Caution: Indicates a potentially hazardous situation which, if not avoided, could result in minor or moderate injury. It may also alert users against unsafe practices.



Notice: Indicates a statement of company policy (that is, a safety policy or protection of property).

The safety guidelines for the equipment in this manual do not purport to address all the safety issues of the equipment. It is the responsibility of the user to establish appropriate safety, ergonomic, and health practices and determine the applicability of regulatory limitations prior to use. Potential safety hazards are identified in this manual through the use of words *Danger*, *Warning*, and *Caution*, the specific hazard type, and pictorial alert icons.

Important Safety Instructions

1. Read these instructions.
2. Keep these instructions.
3. Heed all warnings.
4. Follow all instructions.
5. Do not use this apparatus near water.
6. Clean only with dry cloth.
7. Do not block any ventilation openings. Install in accordance with the manufacturer's instructions.
8. Do not install near any heat sources such as radiators, heat registers, stoves, or other apparatus (including amplifiers) that produce heat.
9. Do not defeat the safety purpose of the polarized or grounding-type plug. A polarized plug has two blades with one wider than the other. A grounding type plug has two blades and a third grounding prong. The wide blade or the third prong are provided for your safety. If the provided plug does not fit into your outlet, consult an electrician for replacement of the obsolete outlet.
10. Protect the power cord from being walked on or pinched particularly at plugs, convenience receptacles, and the point where they exit from the apparatus.
11. Only use attachments/accessories specified by the manufacturer.
12. Refer all servicing to qualified service personnel. Servicing is required when the apparatus has been damaged in any way, such as power-supply cord or plug is damaged, liquid has been spilled or objects have fallen into the apparatus, the apparatus has been exposed to rain or moisture, does not operate normally, or has been dropped.
13. Prior to installation, consult local building and electrical code requirements.

14. WARNING: The speaker enclosure is not rated for any AC voltages!

 <p>GENERAL ALERT</p>	<p>Warning</p> <p><i>Electrical Hazard:</i> This product should be installed by a licensed electrician according to all local electrical and building codes.</p>
 <p>GENERAL ALERT</p>	<p>Warning</p> <p><i>Electrical Hazard:</i> To prevent injury, this apparatus must be securely attached to the floor/wall in accordance with the installation instructions.</p>
 <p>GENERAL ALERT</p>	<p>Warning</p> <p>The PoE connector is intended for intra-building connections only and does not route to the outside plant.</p>

Abbreviations and Terms

Abbreviation or Term	Definition
A-law	A standard companding algorithm, used in European digital communications systems to optimize, i.e., modify, the dynamic range of an analog signal for digitizing.
AVP	Audio Video Profile
Cat 5	TIA/EIA-568-B Category 5
DHCP	Dynamic Host Configuration Protocol
LAN	Local Area Network
LED	Light Emitting Diode
Mbps	Megabits per Second.
NTP	Network Time Protocol
PBX	Private Branch Exchange
PoE	Power over Ethernet (as per IEEE 802.3af standard)
RTFM	Reset Test Function Management
SIP	Session Initiated Protocol
u-law	A companding algorithm, primarily used in the digital telecommunication
UC	Unified Communications
VoIP	Voice over Internet Protocol

Contents

Chapter 1 Product Overview	1
1.1 How to Identify This Product	1
1.2 Installation	2
1.3 Product Features	3
1.4 Supported Protocols	3
1.5 Supported SIP Servers	4
1.6 Product Specifications	5
1.7 Optional Connections (J9 and J10)	6
1.8 Dimensions	6
1.9 Push-To-Talk Speaker Modes	7
1.9.1 Normal Mode	7
1.9.2 Monitor Mode	9
Chapter 2 Installing the VoIP V2 Speaker	11
2.1 Parts List	11
2.2 Device Configuration	12
2.2.1 Connect Power to the Speaker	13
2.2.2 Installation Options	16
2.2.3 Confirm that the Speaker is Operational and Linked to the Network	21
2.2.4 Confirm the IP Address and Test the Audio	22
2.2.5 Adjust the Volume	23
2.2.6 How to Set the Factory Default Settings	24
2.3 Configure the Speaker Parameters	25
2.3.1 Talkback Speaker Web Page Navigation	26
2.3.2 Log in to the Configuration Home Page	27
2.3.3 Configure the Device Parameters	30
2.3.4 Configure the Network Parameters	33
2.3.5 Configure the SIP Parameters	35
2.3.6 Configure the Night Ringer Parameters	40
2.3.7 Configure the Multicast Parameters	42
2.3.8 Configure the Audio Parameters	45
2.3.9 Configure the NTP Server and Clock Parameters	51
2.3.10 Configure the Event Parameters	56
2.3.11 Configure the Autoprovisioning Parameters	61
2.3.12 Upgrade the Firmware and Reboot the Talkback Speaker	66
2.4.1 Command Interface Post Commands	71
Appendix A Mounting the Speaker	75
A.1 Important Safety Instructions	75
A.2 Mount the Speaker	76
Appendix B Setting up a TFTP Server	79
B.1 Set up a TFTP Server	79
B.1.1 In a LINUX Environment	79
B.1.2 In a Windows Environment	79
Appendix C Troubleshooting/Technical Support	80
C.1 Frequently Asked Questions (FAQ)	80
C.2 Documentation	80
C.3 Contact Information	81
C.4 Warranty	82
C.4.1 Warranty & RMA Returns within the United States	82
C.4.2 Warranty & RMA Returns Outside of the United States	82
C.4.3 Spare in the Air Policy	82
C.4.4 Return and Restocking Policy	83
C.4.5 Warranty and RMA Returns Page	83

1 Product Overview

The CyberData SIP-enabled V2 Speaker is a Power-over-Ethernet (PoE 802.3af) and Voice-over-IP (VoIP) public address loudspeaker that easily connects into existing local area networks with a single CAT5 cable connection. The speaker is compatible with most SIP-based IP PBX. In a non-SIP environment, the speaker is capable of receiving broadcast audio via multicast. Its small footprint and low height allows the speaker to be discretely mounted almost anywhere.

Note Prior to installation, create a plan for the locations of your speakers.

	<p>General Alert Consult local building and electrical code requirements prior to installation.</p>
---	---

1.1 How to Identify This Product

To identify the VoIP V2 Speaker, look for a model number label similar to the one shown in [Figure 1-1](#). The model number on the label should be one of the following:

- **011180**, RAL 9002, Gray White, Standard Color
- **011181**, RAL 9003, Signal White, Optional Color

Figure 1-1. Model Number Label

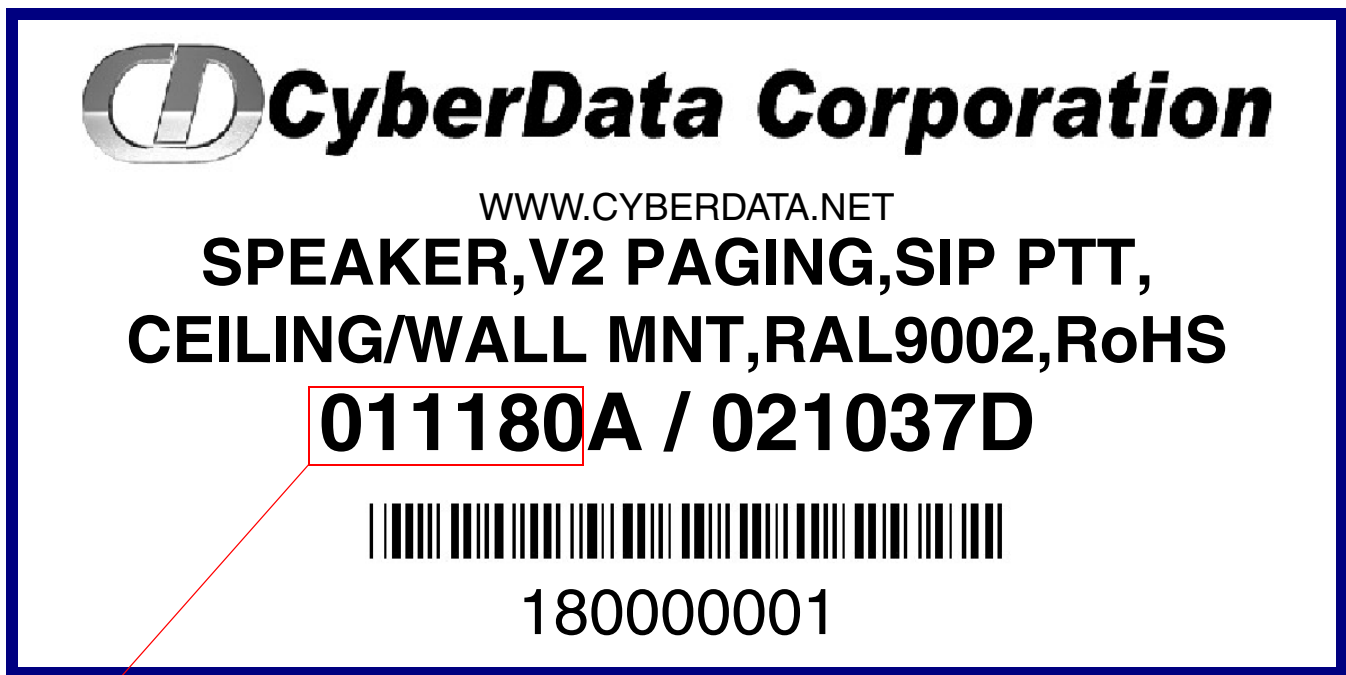

Model number

1.2 Installation





	<p>Warning <i>Electrical Hazard:</i> The speaker enclosure is not rated for any AC voltages.</p>
	<p>Warning <i>Electrical Hazard:</i> This product should be installed by a licensed electrician according to all local electrical and building codes.</p>
	<p>Warning <i>Electrical Hazard:</i> To prevent injury, this apparatus must be securely attached to the floor/wall in accordance with the installation instructions.</p>
	<p>Warning The PoE connector is intended for intra-building connections only and does not route to the outside plant.</p>

Figure 1-2 illustrates a typical configurations for the VoIP V2 Speaker.

Figure 1-2. Typical Installation

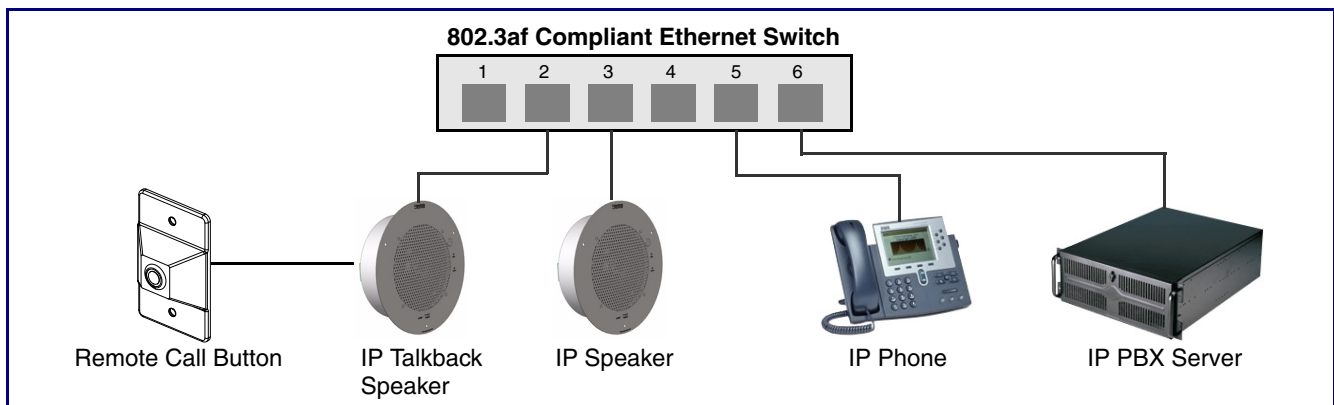

See the following sections for other installation options:

- [Section 2.2.1.3, "Running the Talkback Speaker with Auxiliary Power"](#)
- [Section 2.2.2.2, "Talkback Speaker with an External Device"](#)
- [Section 2.2.2.3, "Talkback Speaker with Auxiliary Speaker Connection"](#)
- [Section 2.2.2.4, "Talkback Speaker with Line Out"](#)

1.3 Product Features

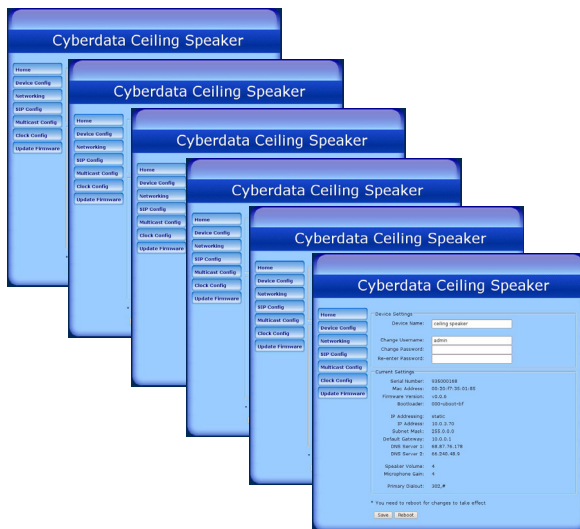

- SIP (RFC 3261) compatible
- Web-based configuration
- Web-based firmware upgradeable
- Autoprovisioning support
- Small footprint
- High efficiency speaker driver
- PoE 802.3af Enabled (Powered-over-Ethernet)
- Network and external speaker volume control
- Peer-to-peer capability
- User-uploadable ring and alert tones
- Auto detect for CyberData Clock kit
- Nightringer
- Buffered page

1.4 Supported Protocols

The V2 Speaker supports:

- SIP
 - Provides an intuitive user interface for easy system configuration and verification of speaker operations.
- Multicast
- HTTP Web-based configuration
 - Dynamically assigns IP addresses in addition to the option to use static addressing.
- DHCP Client
 - Facilitates hosting for the configuration file for Autoprovisioning.
- HTTP TCP Post auto-updating event notification in XML format
- TFTP Client
 - Facilitates hosting for the configuration file for Autoprovisioning.
- Audio Encodings
 - PCMU (G.711 mu-law)
 - PCMA (G.711 A-law)
 - Packet Time 20 ms

1.5 Supported SIP Servers

The following link contains information on how to configure the speaker for the supported SIP servers:

<http://www.cyberdata.net/support/server/index.html>

1.6 Product Specifications

Table 1-1. Product Specifications

Category	Specification
Audio sensitivity	96dB/1W/1M S.P. Level
Audio output	10 Watts Peak Power
Operating temperature	-30 to 55 C (-22 to 131 F)
Ethernet port baud rate	10/100 Mbps
Protocol	SIP RFC 3261 Compatible
Power Input (J1)	PoE 802.3af (as per IEEE 802.3af standard from a UL-listed, LPS-rated limited power source) 44-57 VDC (48 VDC nominal) at 350mA
or Auxiliary Power Input ^a (Terminal Block J10)	12 VDC at 1A (from a UL-listed, LPS-rated power supply)
Payload types	G711, A-law and μ -law
Regulatory compliance	FCC Class B, CE
Warranty	2 years limited
Dimensions	9" x 2.4"
Weight	2.8 lbs./shipping weight of 3.8 lbs. (1.3 kg/shipping weight of 1.7 kg)
Part number	011180 , RAL 9002, Gray White, Standard Color 011181 , RAL 9003, Signal White, Optional Color

a. Auxiliary power input for use when PoE power is not available. 12 VDC @ 1A. Do not use auxiliary power input when speaker J1 is connected to a PoE power source.

1.7 Optional Connections (J9 and J10)

Figure 1-3. Optional Connections (J9 and J10)

Function	J10 Connections	J9 Connections	Function
*Auxiliary power input for use when PoE power is not available. 12 VDC @ 1A.	AUX POWER (+) (+12VDC @ 1A)	AUX SPEAKER (-)	Auxiliary 8-Ohm speaker connection (not to be used when the Clock is connected).
	AUX POWER (-)	AUX SPEAKER (+)	
Relay contacts rated at 30 VDC @ 1A.	RELAY COM	BTN SENSE GND	
	RELAY NO	LINE OUT (-)	Audio line - level output to external audio amplifier. 2v P-P into 10k Ohms.
	BUTTON LED (+)	LINE OUT (+)	
	BTN SENSE	BUTTON LED (-)	

J10 J9

*Do not use auxiliary power input when speaker J1 is connected to a PoE power source.

1.8 Dimensions

Figure 1-4 shows the dimensions for the V2 Speaker.

Figure 1-4. Dimensions

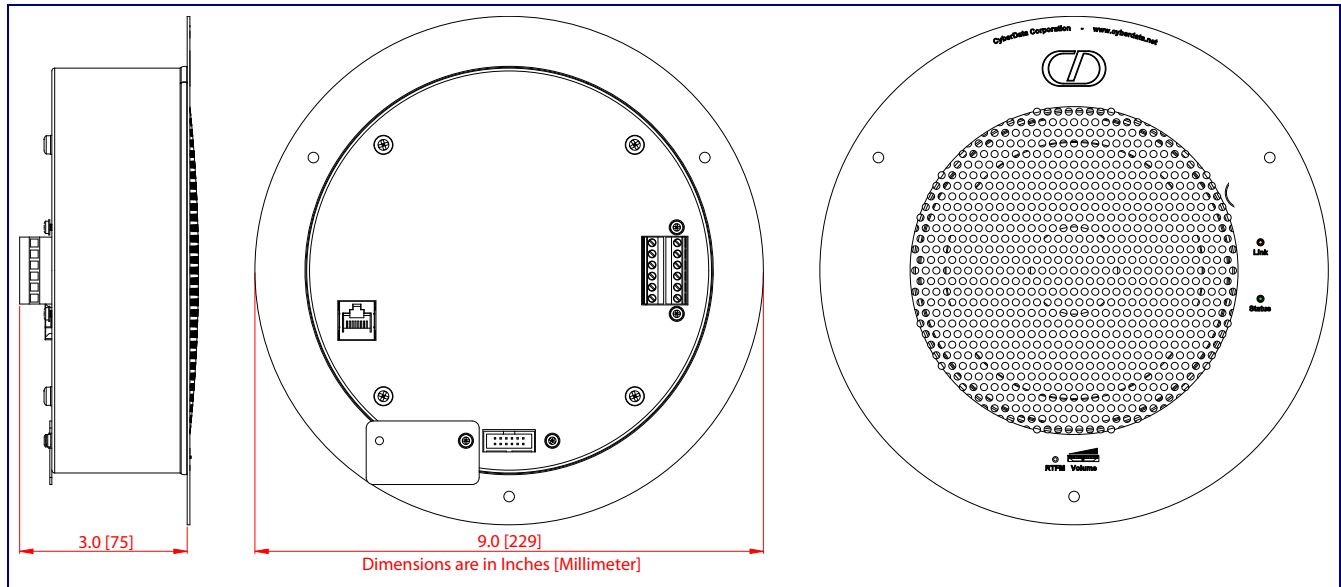

1.9 Push-To-Talk Speaker Modes

1.9.1 Normal Mode

- In **Normal Mode**, a person can use the Remote Call Button and the Talkback Speaker to call an IP phone or a phone user can call the talkback speaker. See [Figure 1-5](#).

Figure 1-5. Normal Mode

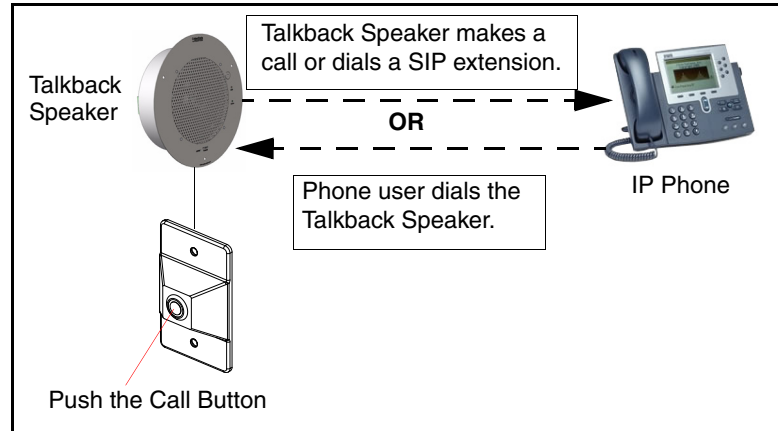

- Push the Call Button to make a call or dial the SIP extension. See [Figure 1-6](#).

Figure 1-6. Push the Call Button to Make a Call

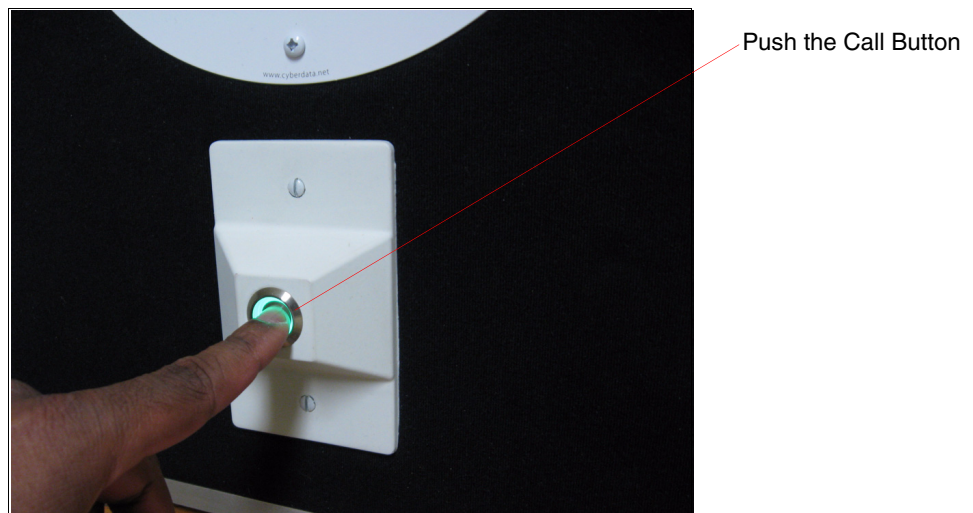

- To talk to someone on the other end, the person at the V2 Speaker, must hold down the Call Button while they are talking to the person on the other end. See [Figure 1-7](#).

Figure 1-7. Hold Down the Call Button While Talking

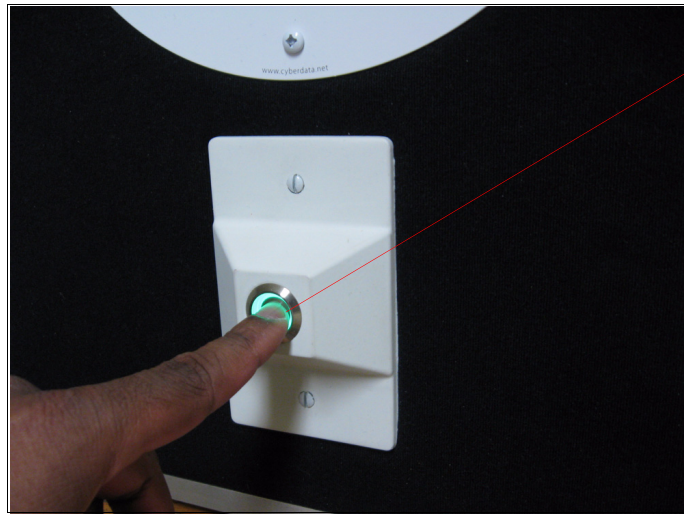

Hold down the Call Button while talking

- To listen to someone talking on the other end, the person at the V2 Speaker must release the Call Button. See [Figure 1-8](#).

Figure 1-8. Release the Call Button While Listening

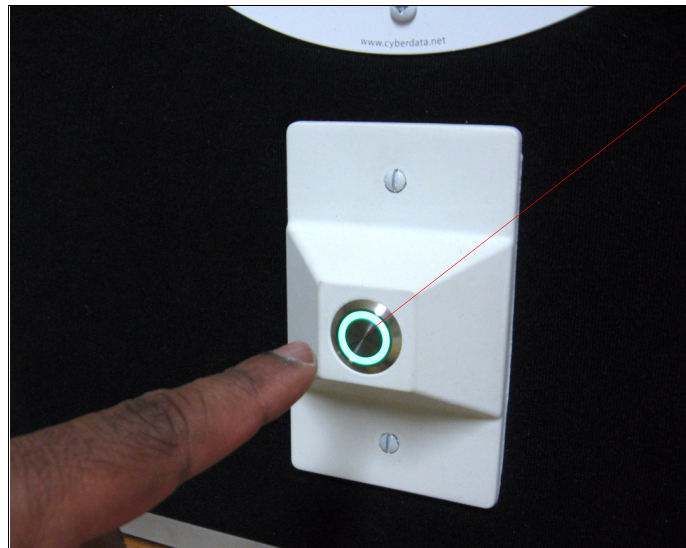

Release the Call Button while listening

1.9.2 Monitor Mode

- In **Monitor Mode**, the person on the phone can listen to any activity that is occurring near the Push-to-Talk Speaker. See [Figure 1-9](#).

Figure 1-9. Monitor Mode

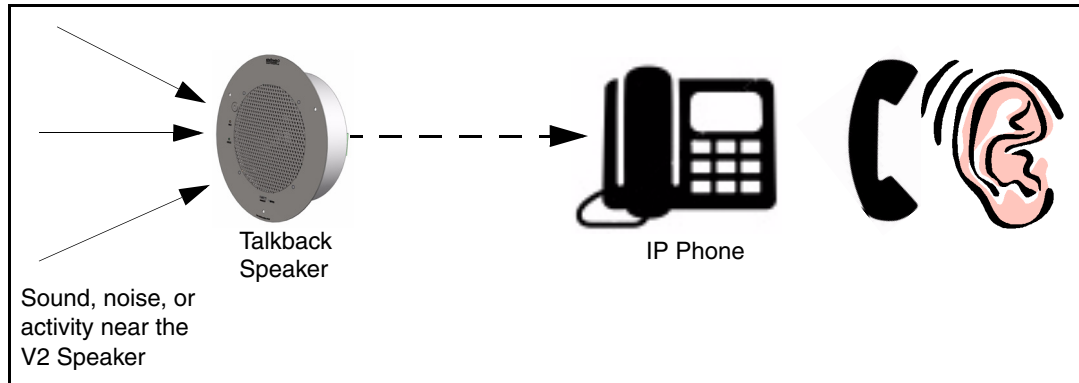

- The Call Button is not used during **Monitor Mode**.
- **Monitor Mode** is controlled by the phone instead of the Push-to-Talk Speaker.
- To initiate the **Monitor Mode**, someone on a phone must dial the pre-programmed **Monitor Extension**. See [Figure 1-10](#).

Figure 1-10. Dial the Monitor Extension



Dial the pre-programmed Monitor Extension

- In **Monitor Mode**, the "talking mode" and the "listening mode" are controlled by one of the pre-programmed buttons on the phone keypad. Therefore, if someone is in the "listening mode," they must press a pre-programmed keypad button to enter the "talking mode." Conversely, if someone is in the "talking mode," they must press a pre-programmed keypad button to enter the "listening mode."

Figure 1-11. Talking and Listening Modes are Controlled by the Phone Keypad



Talking and listening modes are controlled by the phone keypad



2 Installing the VoIP V2 Speaker

2.1 Parts List

Table 2-1 illustrates the parts for each speaker and includes kits for the drop ceiling and drywall mounting.

Note The installation template for the Talkback Speaker is located on the *Installation Quick Reference Guide* that is included in the packaging with each speaker.

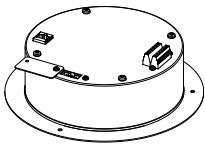
Table 2-1. Parts

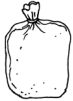
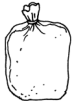
Quantity	Part Name	Illustration
1	Talkback Speaker Assembly	
1	Installation Quick Reference Guide	
1	Speaker Mounting Accessory Kit (Part #070054A)	
1	Remote Call Button Accessory Kit (Part #071011A)	

2.2 Device Configuration

Set up and configure each speaker *before* you mount it.

CyberData delivers each speaker with the following factory default values:

Table 2-2. Factory Network Default Settings—Default of Network

Parameter	Factory Default Setting
IP Addressing	DHCP
IP Address ^a	10.10.10.10
Web Access Username	admin
Web Access Password	admin
Subnet Mask ^a	255.0.0.0
Default Gateway ^a	10.0.0.1

a. Default if there is not a DHCP server present.

2.2.1 Connect Power to the Speaker

Figure 2-1 through Figure 2-3 illustrates how to connect power to the VoIP V2 Speaker.

2.2.1.1 Push-to-Talk V2 Speaker to a 802.3af Compliant PoE Switch

Figure 2-1 illustrates how to connect the VoIP V2 Speaker to a 802.3af compliant PoE switch via a Cat 5 Ethernet cable.

Figure 2-1. Push-to-Talk V2 Speaker to a 802.3af Compliant PoE Switch

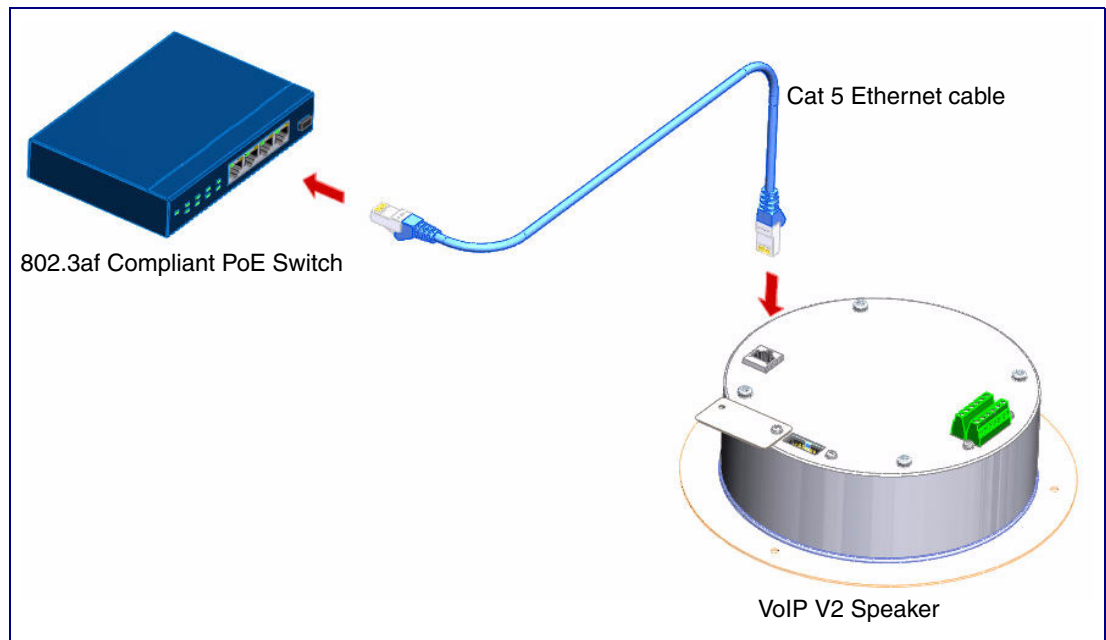

2.2.1.2 Push-to-Talk V2 Speaker (with PoE Injector) to a 802.3af Compliant PoE Switch

In [Figure 2-2](#), if a PoE switch is not available, you will need a PoE Injector, part #010867A (ordered separately). A PoE Injector is a power supply solution for those who have a standard Non PoE Switch.

Figure 2-2. Push-to-Talk V2 Speaker (with PoE Injector) to a Non PoE Switch

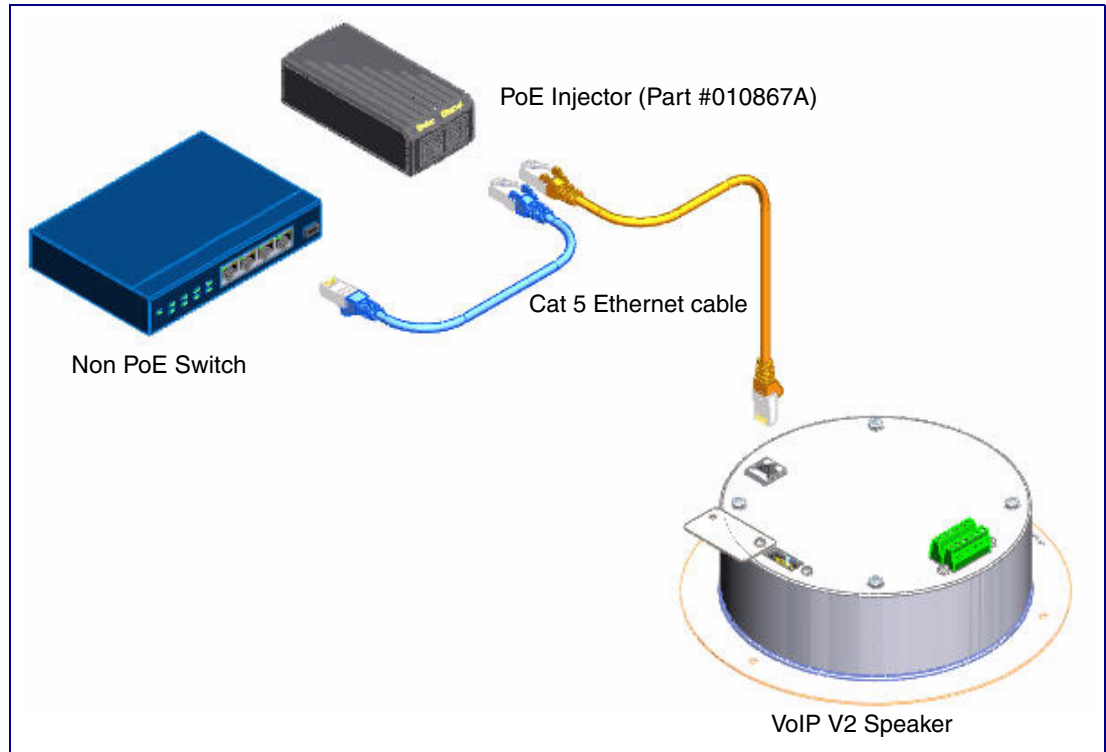

2.2.1.3 Running the Talkback Speaker with Auxiliary Power

In [Figure 2-3](#), the power for the Talkback Speaker can either come from an 802.3af Network connection or from an external source.

 <p>GENERAL ALERT</p>	<p>Caution</p> <p><i>Operational Note:</i> Do not connect an auxiliary power supply when the Talkback Speaker is connected to a PoE power source through J1. Improper operation or equipment damage may occur.</p>
--	---

Figure 2-3. Running the V2 Speaker with Auxiliary Power



2.2.2 Installation Options

This section shows various installation options for the Talkback Speaker.

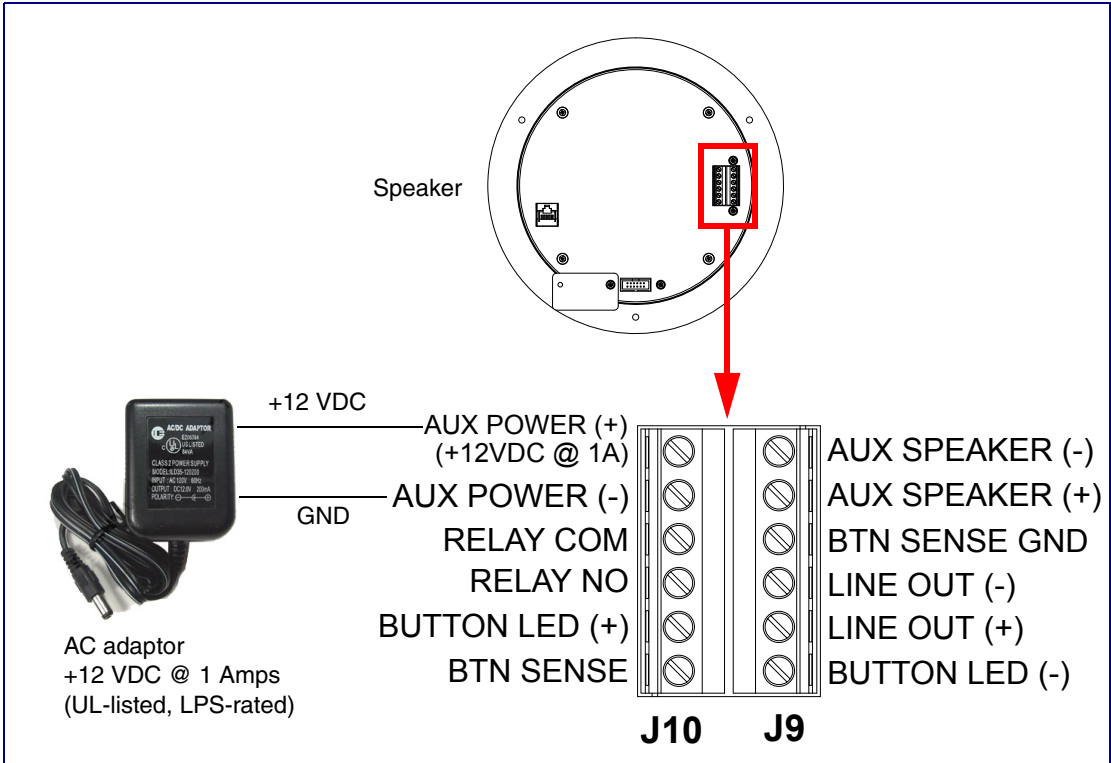
2.2.2.1 Running the Talkback Speaker with a Remote Call Button

In [Figure 2-3](#), the VoIP Remote Call Button enables calls to the SIP Talkback Speaker that can be initiated or answered from a remotely-mounted switch. When enabled through the web interface, if the Remote Call Button is pressed, the speaker would initiate a SIP call to a predetermined extension.

When the SIP Talkback Speaker is called from a remote phone and Auto-Answer is not enabled within the unit's Web interface, the LED on the Remote Button will blink. The call will be answered when the button is pressed.

Figure 2-4. Running the V2 Speaker with a Remote Call Button

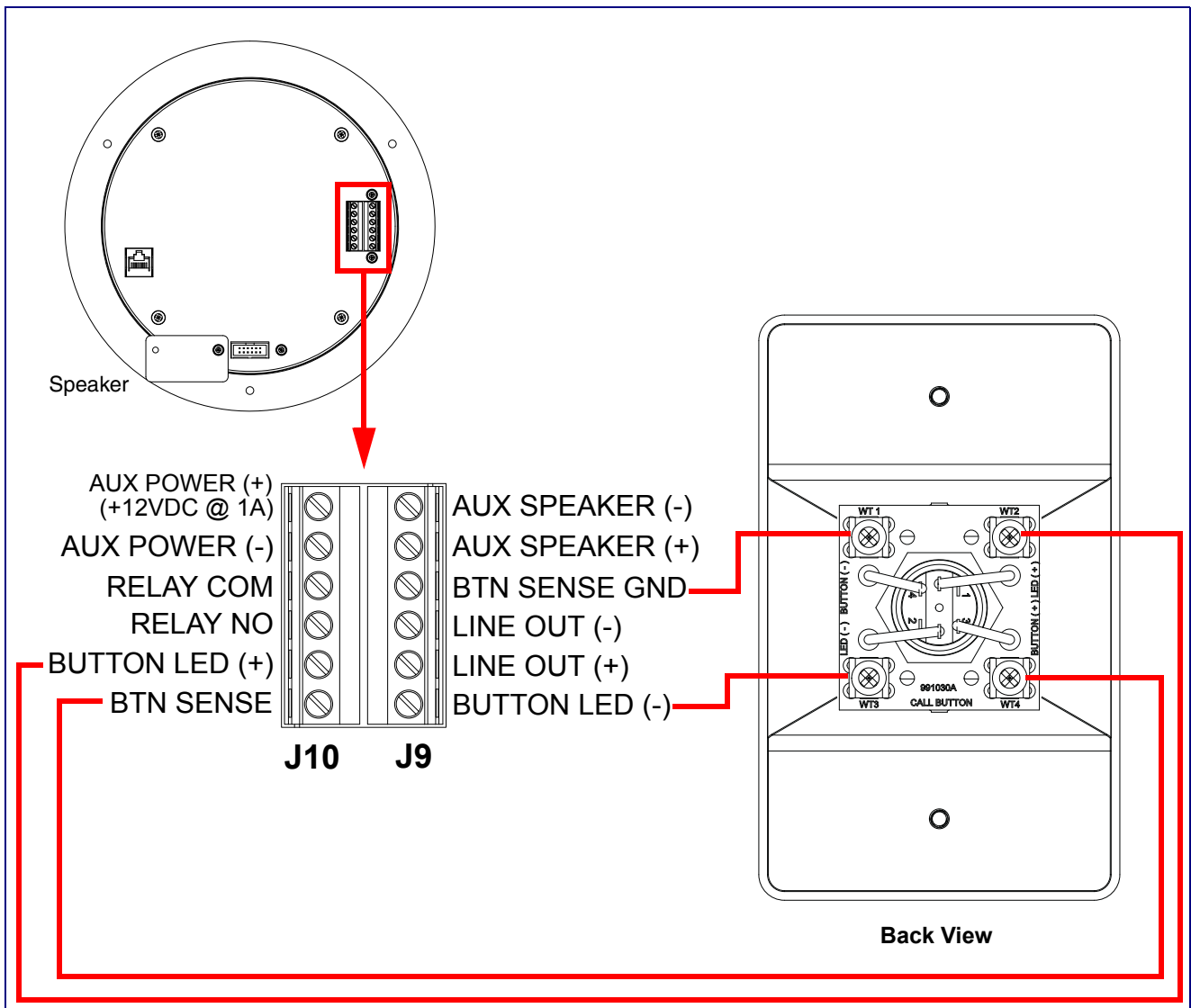

2.2.2.2 Talkback Speaker with an External Device

In [Figure 2-5](#), when the Talkback Speaker is called from a remote phone, the relay on the speaker can be programmed to drive an external device such as an alert strobe. This external device may also be addressed from a separate Unified Communication (UC) server.

Figure 2-5. Talkback Speaker with an External Device

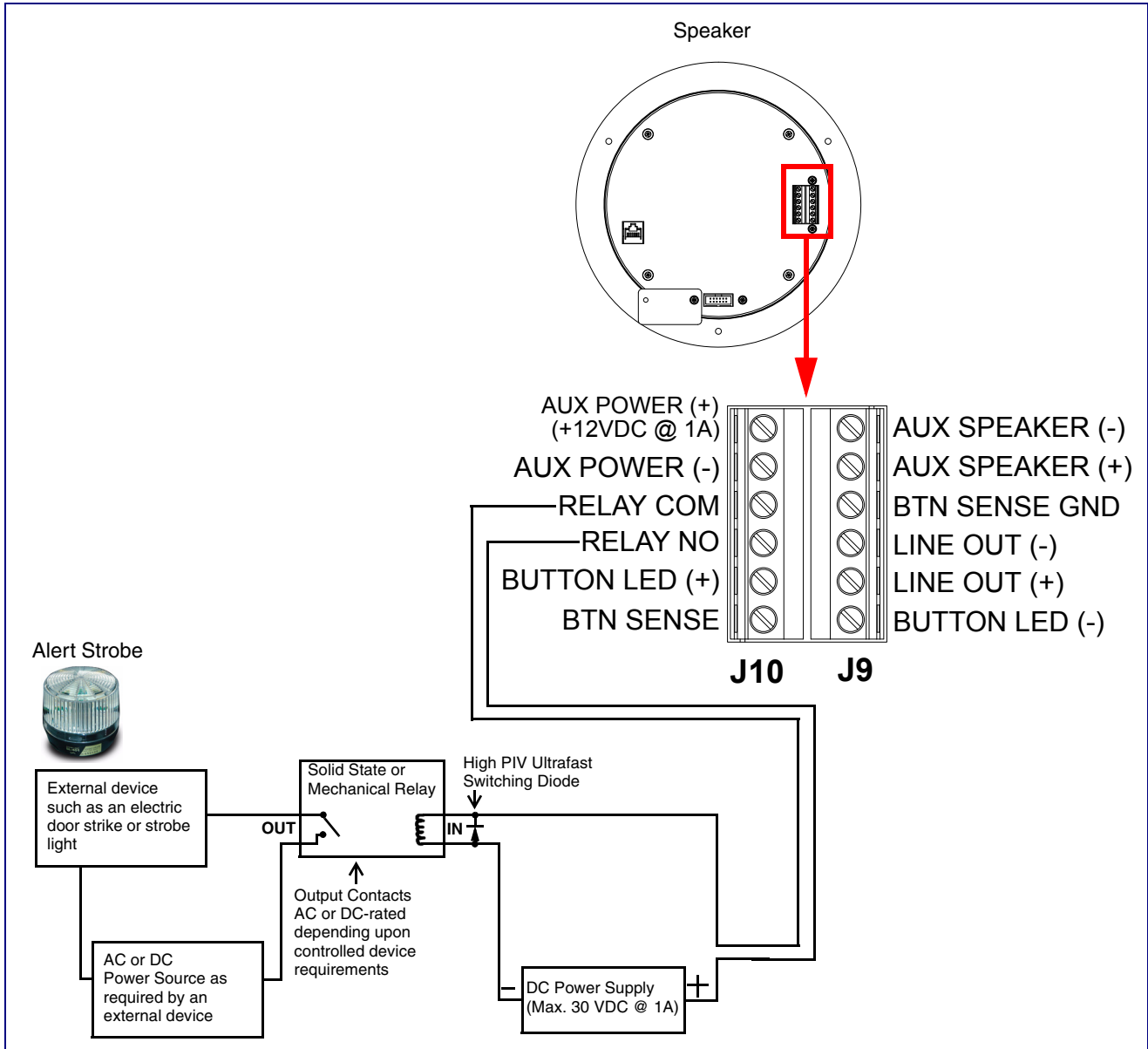

2.2.2.3 Talkback Speaker with Auxiliary Speaker Connection

In [Figure 2-6](#), the Talkback Speaker supports an amplified audio output for a second analog speaker. While the total speaker wattage is the same, by connecting a low cost analog speaker, additional coverage can be realized.

 <small>GENERAL ALERT</small>	<p>Caution</p> <p><i>Operational Note:</i> Because of the limitations of PoE power, when running the Talkback Speaker with a second auxiliary speaker, the analog or digital volume level setting must not exceed a setting of 6.</p>
---	--

Figure 2-6. Talkback Speaker with Auxiliary Speaker Connection



 <small>GENERAL ALERT</small>	<p>Caution</p> <p><i>Operational Note:</i> You must not use the Talkback Speaker in combination with both a Clock Kit and an auxiliary speaker. The V2 Speaker may only be used separately with an auxiliary speaker or used separately with a Clock Kit. See Figure 2-7, "Clock Kit with Extra Speaker Connection is NOT ALLOWED."</p>
---	--

Figure 2-7. Clock Kit with Extra Speaker Connection is **NOT ALLOWED**.

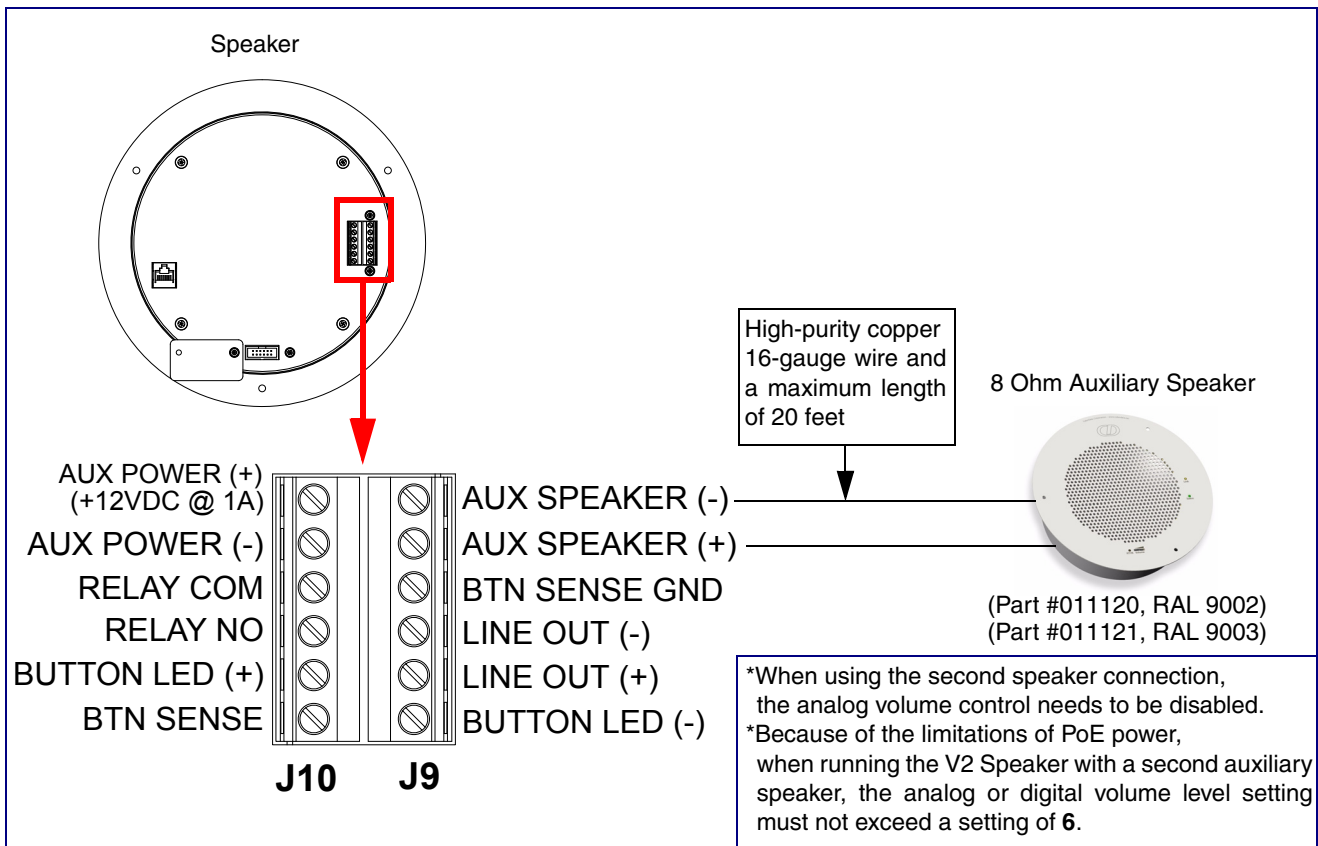

2.2.2.4 Talkback Speaker with Line Out

In [Figure 2-8](#), for areas that require more speaker volume, the Talkback Speaker can be connected directly to an auxiliary amplifier to drive additional horns or speakers. This is done through the line-out connection.

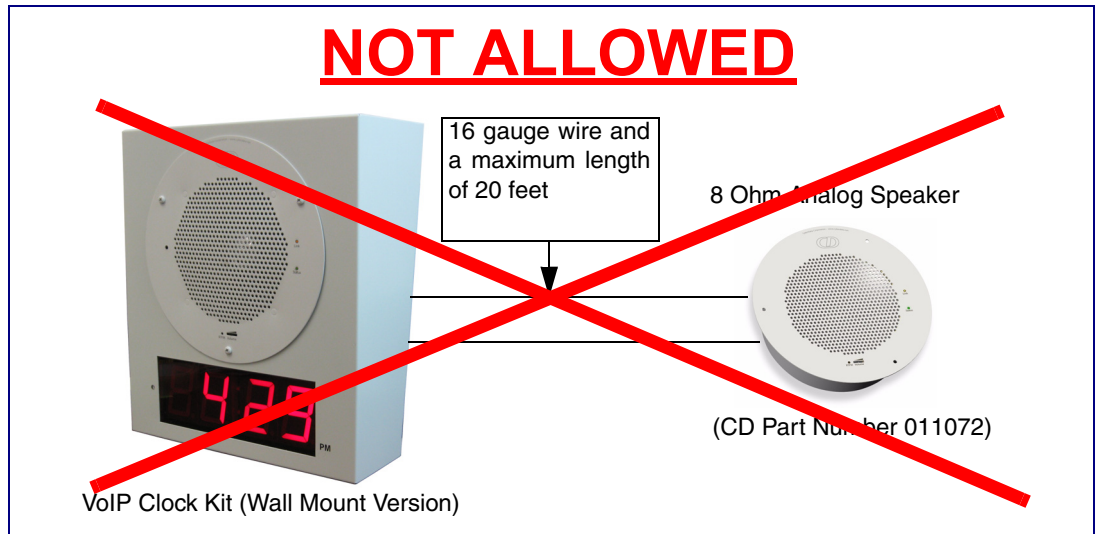
Figure 2-8. Talkback Speaker with Line Out

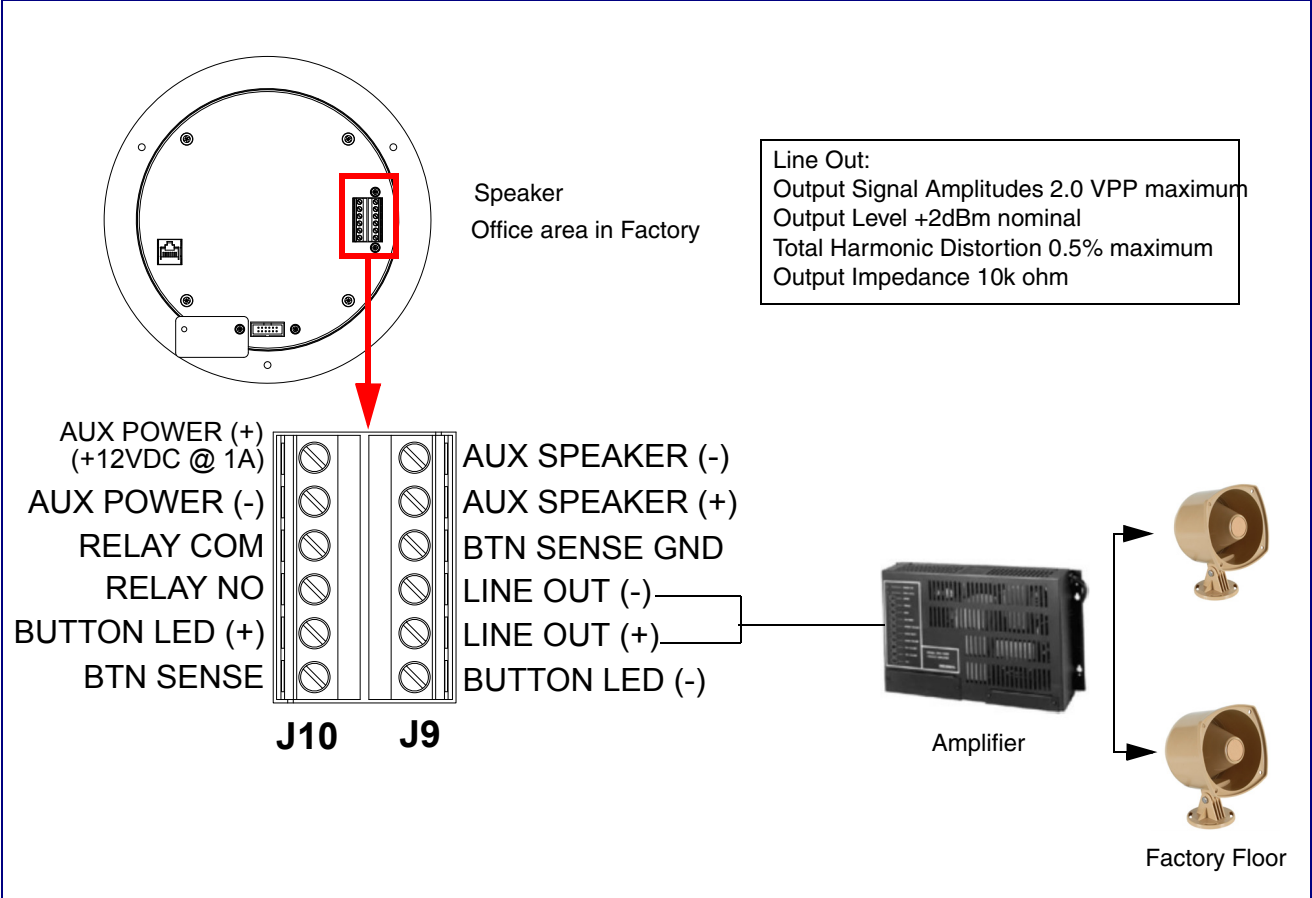

2.2.3 Confirm that the Speaker is Operational and Linked to the Network

After connecting the speaker to the 802.3af compliant Ethernet hub, the LEDs on the speaker face confirm that the speaker is operational and linked to the network.

Figure 2-9. Status and Activity LEDs

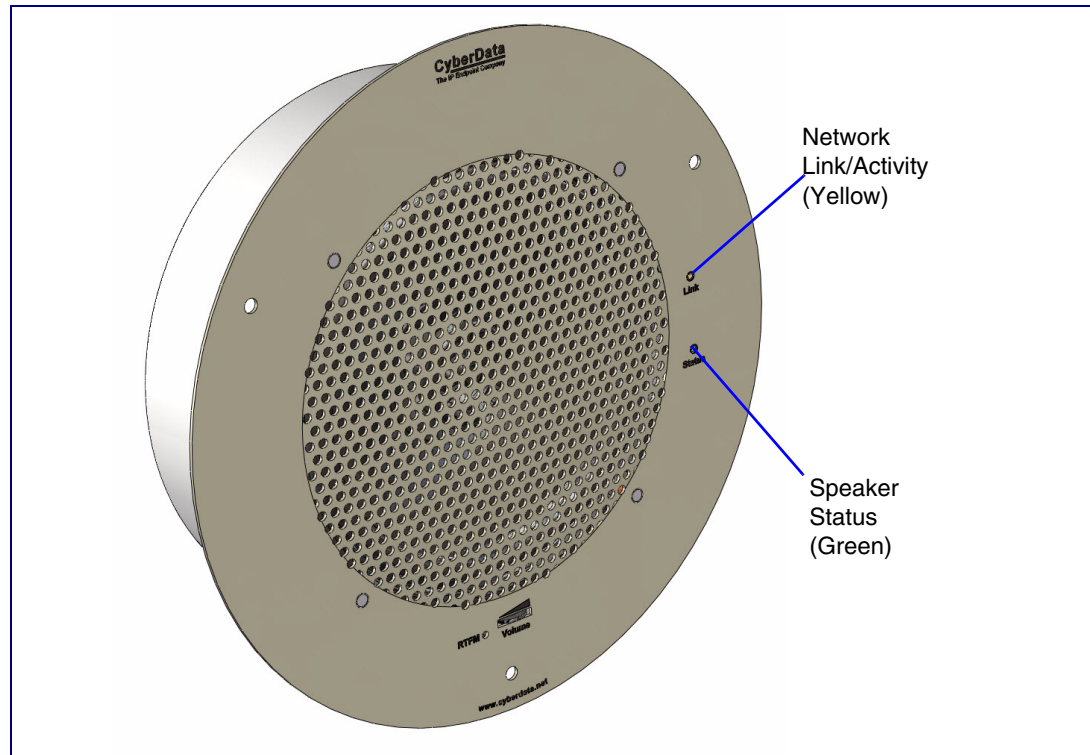

2.2.3.1 Status LED

After supplying power to the speaker:

1. The green power/status LED and the yellow network LED comes on immediately.
2. After about 23 seconds with a static IP address (or 27 seconds if the board is set to use DHCP), the green LED will blink twice to indicate that the board is fully booted. The speaker will beep at this time if the **Beep on Initialization** option is enabled on the **Device Configuration Page** (see [Section 2.3.3, "Configure the Device Parameters"](#)).

Note If the board is set to use DHCP and there is not a DHCP server available on the network, it will try 12 times with a three second delay between tries and eventually fall back to the programmed static IP address (by default 10.10.10.10). This process will take approximately 80 seconds.

Note The front power/status LED will remain solid on during operation.

2.2.3.2 Link LED

- The **Link** LED is illuminated when the network link to the speaker is established.
- The **Link** LED blinks to indicate network traffic.

2.2.4 Confirm the IP Address and Test the Audio

2.2.4.1 Reset Test Function Management (RTFM) Button

When the speaker is operational and linked to the network, use the Reset Test Function Management (RTFM) button (Figure 2-10) on the speaker face to announce and confirm the speaker's IP Address and test that the audio is working.

Note Using the RTFM button will lock the digital volume level to 4 and disable the analog volume control dial.

Figure 2-10. RTFM Button

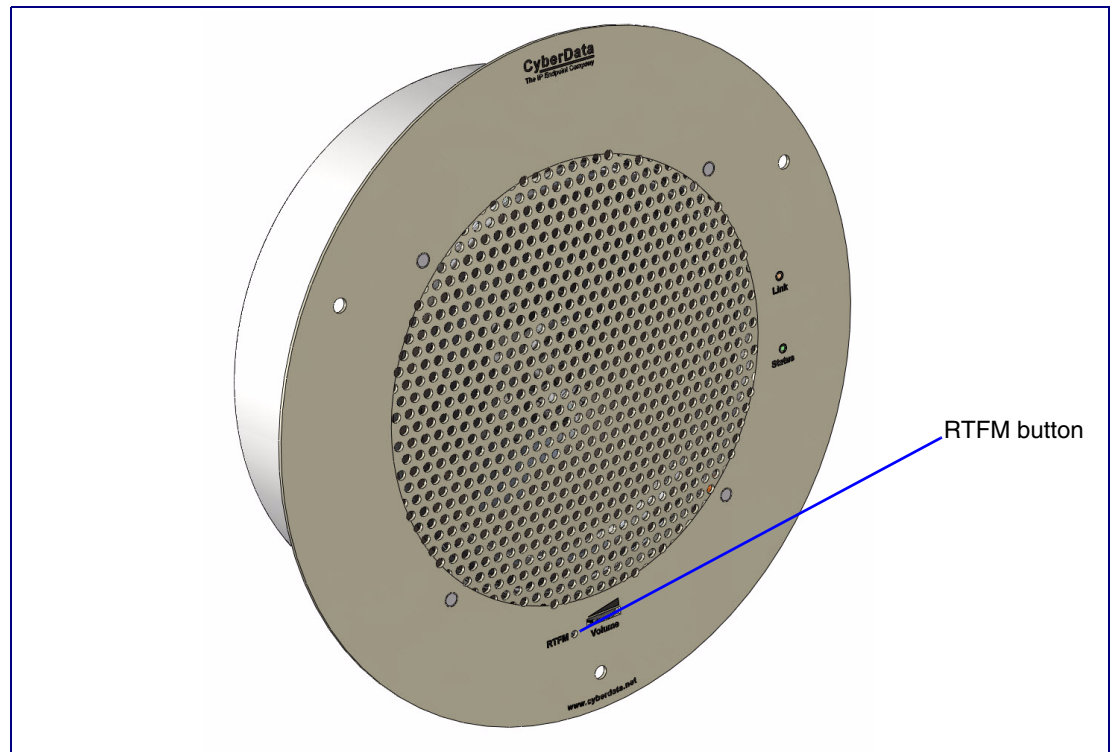

To announce a speaker's current IP address, press and release the RTFM button within a five second window.

Note The speaker will use DHCP to obtain the new IP address (DHCP-assigned address or default to 10.10.10.10 if a DHCP server is not present).

Note Pressing and holding the RTFM button for longer than five seconds will restore the speaker to the factory default settings.

2.2.5 Adjust the Volume

To adjust the speaker volume, turn the **Volume** control dial (Figure 2-11) on the speaker face.

Note The Talkback Speaker has two volume controls: **Internal** (web-based) and **External** (volume knob). The external volume control can be disabled from the web interface by selecting **Use Digital Volume Control** on the **Device Configuration Page** (see Section 2.3.3, "Configure the Device Parameters").

Figure 2-11. Volume Control

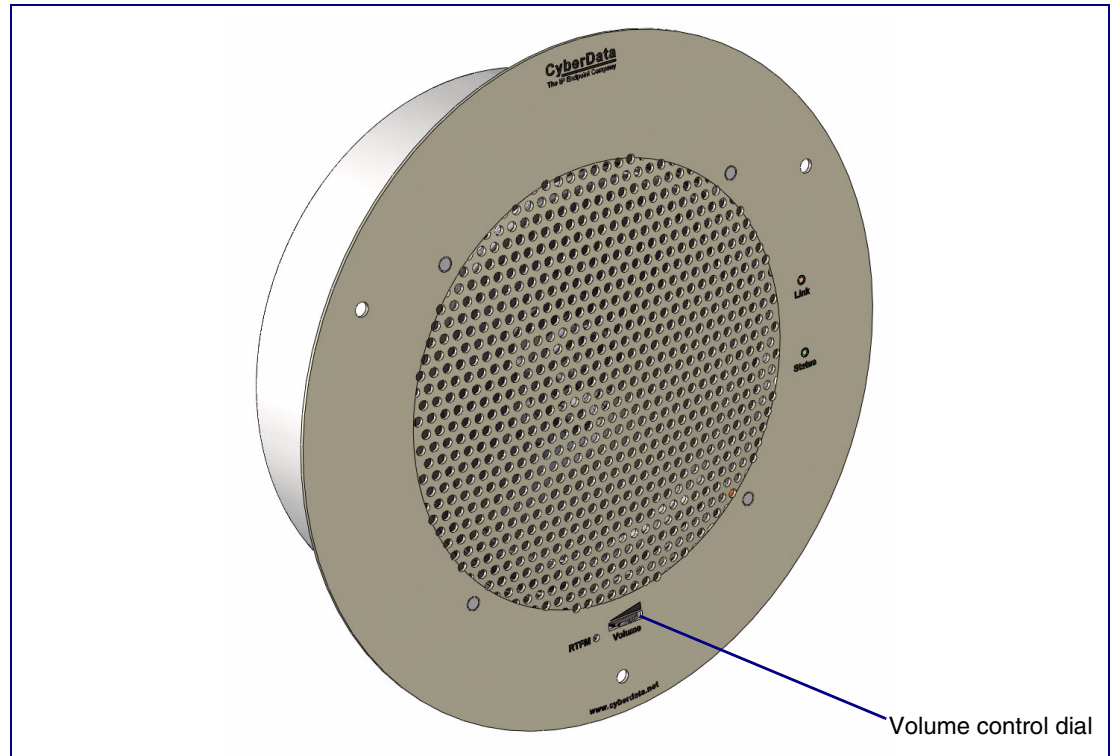

2.2.6 How to Set the Factory Default Settings

2.2.6.1 RTFM Button

When the speaker is operational and linked to the network, use the Reset Test Function Management (RTFM) button (Figure 2-12) on the speaker face to set the factory default settings.

Figure 2-12. RTFM Button

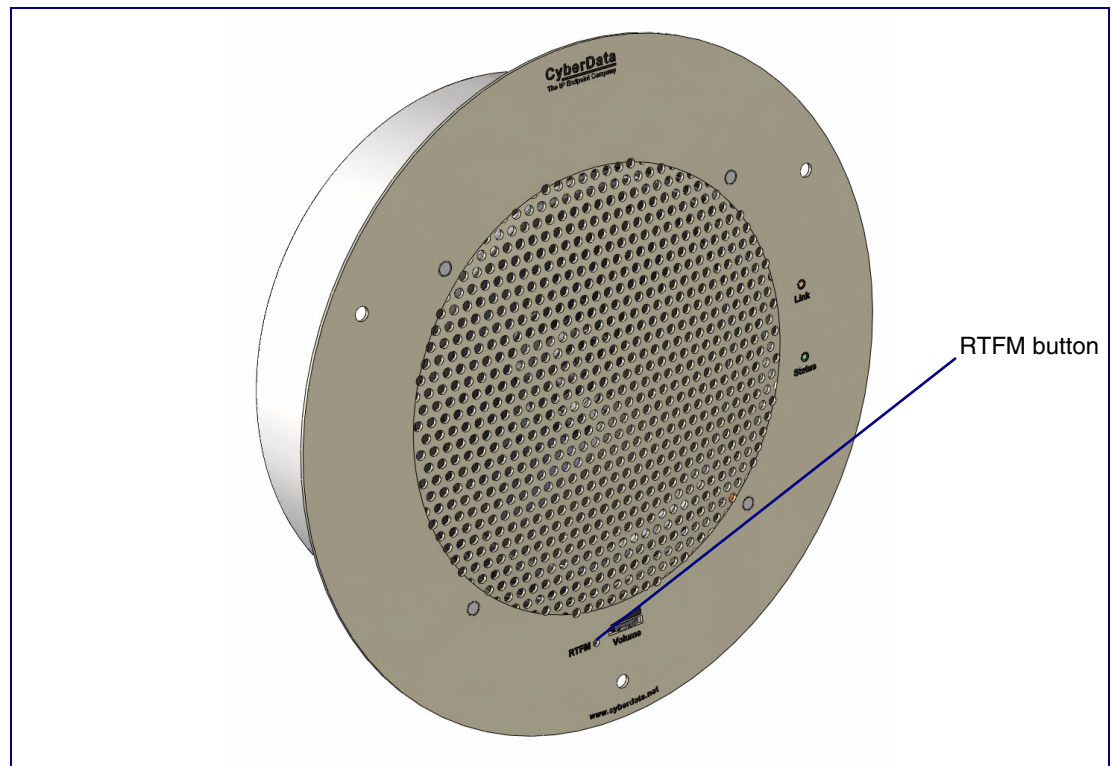

To set the factory default settings:

1. Press and hold the **RTFM** button for more than five seconds.
2. The speaker announces that it is restoring the factory default settings.

Note The speaker will use DHCP to obtain the new IP address (DHCP-assigned address or default to 10.10.10.10 if a DHCP server is not present).

2.3 Configure the Speaker Parameters

To configure the speaker online, use a standard web browser.

Configure each speaker and verify its operation *before* you mount it. When you are ready to mount a speaker, refer to [Appendix A, "Mounting the Speaker"](#) for instructions.

All speakers are initially configured with the default IP settings indicated in [Table 2-3](#):

Note When configuring more than one speaker, attach the speakers to the network and configure one at a time to avoid IP address conflicts

Table 2-3. Factory Network Default Settings—Default of Network











Parameter	Factory Default Setting
IP Addressing	DHCP
IP Address ^a	10.10.10.10
Web Access Username	admin
Web Access Password	admin
Subnet Mask ^a	255.0.0.0
Default Gateway ^a	10.0.0.1

a. Default if there is not a DHCP server present.

2.3.1 Talkback Speaker Web Page Navigation

Table 2-4 shows the navigation buttons that you will see on every Talkback Speaker web page.

Table 2-4. V2 Paging Amplifier Web Page Navigation

Web Page Item	Description
	Link to the Home page.
	Link to the Device Configuration page.
	Link to the Networking page.
	Link to go to the SIP Configuration page.
	Link to go to the Nightringer page.
	Link to the Multicast Configuration page.
	Link to the Audio Configuration page.
	Link to the Clock Configuration page. ^a
	Link to the Event Configuration page.
	Link to the Autoprovisioning Configuration page.
	Link to the Update Firmware page.

a. This page is used only if the CyberData Clock Kit (part number 011023 [wall-mounted version] or 011024 [flush-mounted version]) is installed.

2.3.2 Log in to the Configuration Home Page

1. Open your browser to the Talkback Speaker IP address.

Note If the network does not have access to a DHCP server, the device will default to an IP address of 10.10.10.10.

Note Make sure that the PC is on the same IP network as the Talkback Speaker.

Note You may also download CyberData's VoIP Discovery Utility program which allows you to easily find and configure the default web address of the CyberData VoIP products.

CyberData's VoIP Discovery Utility program is available at the following website address:

http://www.cyberdata.net/support/voip/discovery_utility.html

Note The Speaker ships in DHCP mode. To get to the **Home** page, use the discovery utility to scan for the device on the network and open your browser from there.

- When prompted, use the following default **Web Access Username** and **Web Access Password** to access the **Home Page** (Figure 2-13):

Web Access Username: **admin**



Web Access Password: **admin**

Figure 2-13. Home Page



3. On the **Home Page**, review the setup details and navigation buttons described in [Table 2-5](#).

Table 2-5. Home Page Overview

Web Page Item	Description
Device Settings	
Device Name	Shows the device name (25 character limit).
Change Username	Type in this field to change the username (25 character limit).
Change Password	Type in this field to change the password (19 character limit).
Re-enter Password	Type the password again in this field to confirm the new password (19 character limit).
Current Settings	
Serial Number	Shows the device serial number.
Mac Address	Shows the device Mac address.
Firmware Version	Shows the current firmware version.
IP Addressing	Shows the current IP addressing setting (DHCP or Static).
IP Address	Shows the current IP address.
Subnet Mask	Shows the current subnet mask address.
Default Gateway	Shows the current default gateway address.
DNS Server 1	Shows the current DNS Server 1 address.
DNS Server 2	Shows the current DNS Server 2 address.
Speaker Volume	Shows the current speaker volume mode: Digital (web page) or Analog (volume knob).
SIP Mode is	Shows the current status of the SIP Mode.
Multicast Mode is	Shows the current status of the Multicast Mode.
Clock is	Shows the current status of the Clock.
Event Reporting is	Shows the current status of the Event Reporting.
Nightringer is	Shows the current status of the Nightringer.
Primary SIP Server	Shows the current status of the Primary SIP Server.
Backup Server 1	Shows the current status of Backup Server 1.
Backup Server 2	Shows the current status of Backup Server 2.
Monitor SIP Server	Shows the current status of the Monitor SIP Server.
Monitor Server 1	Shows the current status of Monitor Server 1.
Monitor Server 2	Shows the current status of Monitor Server 2.
	Click the Save button to save your configuration settings. Note: You need to reboot for changes to take effect.
	Click on the Reboot button to reboot the system.

2.3.3 Configure the Device Parameters

1. Click the **Device Configuration** button to open the **Device Configuration** page.
See [Figure 2-14](#).

Figure 2-14. Device Configuration Page

CyberData Ceiling Speaker

Device Configuration

Volume Settings

- Use Digital Volume Control:
- Speaker Volume:
- Volume Boost:
- Microphone Gain:

Relay Settings

- Activate Relay with DTMF code:
- DTMF Activation Code:
- DTMF Activation Duration (in seconds):
- Activate Relay During Ring:
- Activate Relay During Night Ring:
- Activate Relay While Call Active:
- Activate Relay on Button Press:
- Relay on Button Press Timeout (in seconds):

Miscellaneous Settings

- Beep on Initialization:
- Auto-Answer Incoming Calls:
- Button Lit when Idle:
- Play Ringback Tone:
- Blink button LED on monitor call:

* You need to reboot for changes to take effect

2. On the **Device Configuration** page, you may enter values for the parameters indicated in [Table 2-6](#).

Table 2-6. Device Configuration Parameters



Web Page Item	Description
Volume Settings	
Use Digital Volume Control	When selected, you can bypass the analog volume knob on the front of the speaker. The volume level will only be determined by the digital Speaker Volume setting on the Device Configuration page.
Speaker Volume	Type the desired speaker volume level into this field (1 character limit).
Volume Boost	When Volume Boost is enabled, the device will play at a higher volume at the risk of having the audio clip at very high levels.
Microphone Gain	Type the desired microphone gain level into this field.
Relay Settings	
Activate Relay with DTMF Code	When selected, the relay can be activated with a DTMF code.
DTMF Activation Code	Type the desired DTMF activation code (25 character limit).
DTMF Activation Duration (in seconds)	Type the desired DTMF activation duration (in seconds) (2 character limit [activation times now go up to 99 seconds]). NOTE: A DTMF activation duration of 0 will toggle the relay indefinitely or until the activation code is sent again
Activate Relay During Ring	When selected, the relay will be activated for as long as the call is active. NOTE: When the phone is set to Auto Answer , it will not ring and this option does nothing.
Activate Relay During Night Ring	Check this box to activate the relay for as long as a Night Ring tone is ringing.
Activate Relay While Call Active	When selected, the relay will be activated for as long as the call is active.
Activate Relay on Button Press	When selected, the relay will be activated when the Call Button is pressed.
Relay on Button Press Timeout (in seconds)	Type the desired time (in seconds) that you want the relay to activate after the Call Button is pressed (1 character limit).
Miscellaneous Settings	
Beep on Initialization	When selected, you will hear a beep when the speaker initializes.
Auto-Answer Incoming Calls	When selected, the device will automatically answer incoming calls. When Auto Answer is Off, the device will play a ringtone through the speaker.
Button Lit When Idle	When selected, the Call Button remains lit when idle.
Play Ringback Tone	When selected, you will hear a ringback tone while making a call.
Blink button LED on monitor call	When selected, the button LED will flash on and off during a monitor call.
	Click the Save button to save your configuration settings. Note: You need to reboot for changes to take effect.

Table 2-6. Device Configuration Parameters (continued)

Web Page Item	Description
	Click on the Test Audio button to do an audio test. When the Test Audio button is pressed, you will hear a voice message for testing the device audio quality and volume.
	Click on the Test Microphone button to do a microphone test. When the Test Microphone button is pressed, the following occurs: <ol style="list-style-type: none">1. The device will immediately start recording 3 seconds of audio.2. The device will beep (indicating the end of recording).3. The device will play back the recorded audio.
	Click on the Test Relay button to do a relay test.
	Click on the Reboot button to reboot the system.

3. After changing the parameters, click the **Save** button.

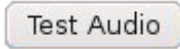
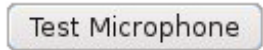
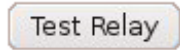
2.3.4 Configure the Network Parameters

1. Click the **Networking** button to open the **Network Configuration** page (Figure 2-15).

Figure 2-15. Network Configuration Page

CyberData Ceiling Speaker

Home **Device Config** **Networking** **SIP Config** **Nightringer** **Multicast Config** **Audio Config** **Clock Config** **Event Config** **Autoprovisioning** **Update Firmware**

Network Configuration

Stored Network Settings

IP Addressing: Static DHCP

IP Address: 10.10.10.10

Subnet Mask: 255.0.0.0

Default Gateway: 10.0.0.1

DNS Server 1: 10.0.0.1

DNS Server 2: 10.0.0.1

DHCP Timeout

DHCP Timeout in seconds*: 60

* A value of -1 will retry forever

Current Network Settings

IP Address: 192.168.1.111

Subnet Mask: 255.255.255.0

Default Gateway: 192.168.1.1

DNS Server 1: 192.168.1.20

DNS Server 2: 192.168.1.10

* You need to reboot for changes to take effect

Save Reboot

2. On the **Network Configuration** page, enter values for the parameters indicated in [Table 2-7](#).

Table 2-7. Network Configuration Parameters

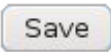
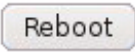
Web Page Item	Description
Stored Network Settings	
IP Addressing	Select either DHCP IP Addressing or Static IP Addressing by marking the appropriate radio button. If you select Static , configure the remaining parameters indicated in Table 2-7 . If you select DHCP , go to Step 3 .
IP Address	Enter the Static IP address.
Subnet Mask	Enter the Subnet Mask address.
Default Gateway	Enter the Default Gateway address.
DNS Server 1	Enter the DNS Server 1 address.
DNS Server 2	Enter the DNS Server 2 address.
DHCP Timeout	
DHCP Timeout in seconds	Enter the desired timeout duration (in seconds) that the device will wait for a response from the DHCP server before defaulting back to the stored static IP address. Note: A value of -1 will cause the device to retry indefinitely and a value of 0 will cause the device to reset to a default of 60 seconds.
Current Network Settings	
IP Address	Shows the current Static IP address.
Subnet Mask	Shows the current Subnet Mask address.
Default Gateway	Shows the current Default Gateway address.
DNS Server 1	Shows the current DNS Server 1 address.
DNS Server 2	Shows the current DNS Server 2 address.
	Click the Save button to save your configuration settings. Note: You need to reboot for changes to take effect.
	Click on the Reboot button to reboot the system.

3. After changing the parameters, click **Save Settings**. This updates the changed parameters and reboots the Talkback Speaker if appropriate.
4. Connect the Talkback Speaker to the target network.
5. From a system on the same network as the Talkback Speaker, open a browser with the new IP address of the Talkback Speaker.

2.3.5 Configure the SIP Parameters

1. Click **SIP Config** to open the **SIP Configuration** page (Figure 2-17).

Note For specific server configurations, go to the following website address:

<http://www.cyberdata.net/support/server/index.html>

Figure 2-16. SIP Configuration Page (continued)

CyberData Ceiling Speaker

SIP Configuration

Home
Device Config
Networking
SIP Config
Nightringer
Multicast Config
Audio Config
Clock Config
Event Config
Autoprovisioning
Update Firmware

Primary SIP Server: (NOT Registered with SIP Server)
Backup Server 1: (NOT Registered with SIP Server)
Backup Server 2: (NOT Registered with SIP Server)
Monitor SIP Server: (NOT Registered with SIP Server)
Monitor Server 1: (NOT Registered with SIP Server)
Monitor Server 2: (NOT Registered with SIP Server)

Enable SIP operation:

SIP Settings

Primary SIP Server:	10.0.0.253
Primary SIP User ID:	199
Primary SIP Auth ID:	199
Primary SIP Auth Password:	●●●●●●
Primary Monitor User ID:	299
Primary Monitor Auth ID:	299
Primary Monitor Auth Password:	●●●●●●
Backup SIP Server 1:	
Backup SIP User ID 1:	
Backup SIP Auth ID 1:	
Backup SIP Auth Password 1:	
Backup Monitor User ID 1:	
Backup Monitor Auth ID 1:	
Backup Monitor Auth Password 1:	

Figure 2-17. SIP Configuration Page (continued)

Backup SIP Server 2:	<input type="text"/>
Backup SIP User ID 2:	<input type="text"/>
Backup SIP Auth ID 2:	<input type="text"/>
Backup SIP Auth Password 2:	<input type="text"/>
Backup Monitor User ID 2:	<input type="text"/>
Backup Monitor Auth ID 2:	<input type="text"/>
Backup Monitor Auth Password 2:	<input type="text"/>
Remote SIP Port:	<input type="text" value="5060"/>
Local SIP Port:	<input type="text" value="5060"/>
Outbound Proxy:	<input type="text"/>
Outbound Proxy Port:	<input type="text" value="0"/>
Register with a SIP Server:	<input checked="" type="checkbox"/>
Re-registration Interval (in seconds):	<input type="text" value="360"/>
Unregister on Reboot:	<input type="checkbox"/>
Beep before Page:	<input type="checkbox"/>
Call disconnection	
Terminate call after delay (in seconds):	<input type="text" value="0"/>
Note: A value of 0 will disable this function	
RTP Settings	
RTP Port (even):	<input type="text" value="10500"/>
Dial Out Settings	
Dial out Extension:	<input type="text" value="204"/>
Extension ID:	<input type="text" value="id204"/>
Monitor	
DTMF toggle key:	<input type="text" value="#"/>

* You need to reboot for changes to take effect

2. On the **SIP Configuration** page, you may enter values for the parameters indicated in [Table 2-8](#).

Table 2-8. SIP Configuration Parameters

Web Page Item	Description
Primary SIP Server	Shows the current status of the Primary SIP Server.
Backup Server 1	Shows the current status of Backup Server 1.
Backup Server 2	Shows the current status of Backup Server 2.
Monitor SIP Server	Shows the current status of the Monitor SIP Server.
Monitor Server 1	Shows the current status of Monitor Server 1.
Monitor Server 2	Shows the current status of Monitor Server 2.
Enable SIP Operation	Enables or disables SIP operation.
SIP Settings	
Primary SIP Server	Use this field to set the address (in dotted decimal notation or as a canonical name) for the Primary SIP Server. This field can accept canonical names of up to 255 characters in length.
Primary SIP User ID	Type the SIP User ID for the Primary SIP Server (up to 64 alphanumeric characters).
Primary Auth ID	Type the Authenticate ID for the Primary SIP Server (up to 64 alphanumeric characters).
Primary Auth Password	Type the Authenticate Password for the Primary SIP Server (up to 64 alphanumeric characters).
Primary Monitor User ID	Type the Monitor User ID for the Primary SIP Server (up to 64 alphanumeric characters).
Primary Monitor Auth ID	Type the Monitor Authenticate ID for the Primary SIP Server (up to 64 alphanumeric characters).
Primary Monitor Auth Password	Type the Monitor Authenticate Password for the Primary SIP Server (up to 64 alphanumeric characters).
Backup SIP Server 1 Backup SIP Server 2	<ul style="list-style-type: none"> • If all of the Primary SIP Server and Backup SIP Server fields are populated, the device will attempt to stay registered with all three servers all of the time. You can leave the Backup SIP Server 1 and Backup SIP Server 2 fields blank if they are not needed. • In the event of a registration failure on the Primary SIP Server, the device will use the next highest priority server for outbound calls (Backup SIP Server 1). If Backup SIP Server 1 fails, the device will use Backup SIP Server 2. • If a higher priority SIP Server comes back online, the device will switch back to this server.
Backup SIP User ID 1 Backup SIP User ID 2	Type the SIP User ID for the Backup SIP Server (up to 64 alphanumeric characters).
Backup SIP Auth ID 1 Backup SIP Auth ID 2	Type the SIP Authenticate ID for the Backup SIP Server (up to 64 alphanumeric characters).
Backup SIP Auth Password 1 Backup SIP Auth Password 2	Type the SIP Authenticate Password for the Backup SIP Server (up to 64 alphanumeric characters).

Table 2-8. SIP Configuration Parameters (continued)

Web Page Item	Description
Backup Monitor User ID 1 Backup Monitor User ID 2	Type the Monitor User ID for the Backup SIP Server (up to 64 alphanumeric characters).
Backup Monitor Auth ID 1 Backup Monitor Auth ID 2	Type the Monitor Authenticate ID for the Backup SIP Server (up to 64 alphanumeric characters).
Backup Monitor Auth Password 1 Backup Monitor Auth Password 2	Type the Monitor Authenticate Password for the Backup SIP Server (up to 64 alphanumeric characters).
Remote SIP Port	Type the Remote SIP Port number (default 5060) (8 character limit).
Local SIP Port	Type the Local SIP Port number (default 5060) (8 character limit).
Outbound Proxy	Type the Outbound Proxy as either a numeric IP address in dotted decimal notation or the fully qualified host name (255 character limit [FQDN]).
Outbound Proxy Port	Type the Outbound Proxy Port number (8 character limit).
Register with a SIP Server	Enable or disable SIP Registration.
Re-registration Interval (in seconds)	Type the SIP Registration lease time in minutes (default is 60 minutes) (8 character limit). Re-registration Interval (in seconds)*
Unregister on Reboot	When selected, on boot, the speaker will first register with a SIP server with a expiration delay of 0 seconds. This has the effect of unregistering any current devices on this extension.
Beep before Page	When selected, the device will play a beep before a page is sent on SIP calls (works for both buffered and live pages).
Call Disconnection	
Terminate call after delay (in seconds)	Type the desired number of seconds that you want to transpire before a call is terminated. Note: A value of 0 will disable this function.
RTP Settings	
RTP Port (even)	Specify the port number used for the RTP stream after establishing a SIP call. This port number has to be an even number and defaults to 10500.
Dial Out Settings	
Dial Out Extension	Type the dial out extension number (64 character limit). Note: For information about dial-out extension strings and DTMF tones, see Section 2.3.5.1, "Dial Out Extension Strings and DTMF Tones (using rfc2833)" .
Extension ID	Type the desired Extension ID (64 character limit).
Monitor	
DTMF toggle key	Specify the phone keypad button that you want to use to toggle back and forth between the talking and listening mode when the device is in Monitor Mode.

Table 2-8. SIP Configuration Parameters (continued)

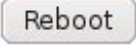
Web Page Item	Description
	Click the Save button to save your configuration settings. Note: You need to reboot for changes to take effect.
	Click on the Reboot button to reboot the system.

3. After changing the parameters, click on the **Save** button.

2.3.5.1 Dial Out Extension Strings and DTMF Tones (using rfc2833)

On the [SIP Configuration Page \(continued\)](#), dial out extensions support the addition of comma delimited pauses and sending additional DTMF tones (using rfc2833). The first comma will pause three seconds after a call is first established with a remote device. Subsequent commas will pause for 2 seconds. A pause of one second will be sent after each numerical digit.

Table 2-9. Examples of Dial-Out Extension Strings

Extension String	Resulting Action
302	Dial out extension 302 and establish a call
302,2	Dial out extension 302 and establish a call, wait 3 seconds then send the DTMF tone '2'
302,25,,,4,,1	Dial out extension 302 and establish a call, wait 3 seconds then send the DTMF tone '2', send out DTMF tone 5, wait 6 seconds, send out DTMF tone 4, wait 4 seconds, send out DTMF tone 1

Note The maximum number of total characters in the dial-out field is 64.

2.3.6 Configure the Night Ringer Parameters

1. Click on the **Nightringer** button to open the **Nightringer Configuration** page. See [Figure 2-18](#).

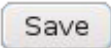

Figure 2-18. Nightringer Configuration Setup

The screenshot shows the 'Nightringer Configuration' page for a 'CyberData Ceiling Speaker'. On the left is a vertical navigation menu with buttons for: Home, Device Config, Networking, SIP Config, Nightringer (highlighted), Multicast Config, Audio Config, Clock Config, Event Config, Autoprovisioning, and Update Firmware. The main content area is titled 'Nightringer Configuration' and contains the following elements:

- 'Enable Nightringer: (NOT Registered with SIP Server)'
- A 'Nightringer Settings' box containing:
 - SIP Server: 10.0.0.253
 - User ID: 207
 - Authenticate ID: 207
 - Authenticate Password: [masked]
 - Re-registration Interval (in seconds): 360
- A note: '* You need to reboot for changes to take effect'
- 'Save' and 'Reboot' buttons.

2. On the **Nightringer Configuration** page, enter values for the parameters indicated in [Table 2-10](#).

Table 2-10. Nightringer Configuration Parameters

Web Page Item	Description
Enable Nightringer	When the nightringer is enabled, the ceiling speaker will attempt to register a second extension with the SIP server. Any calls made to this extension will play a ringtone.
Nightringer Settings	
SIP Server	Type the SIP server represented as either a numeric IP address in dotted decimal notation.
User ID	Type the User ID (up to 64 alphanumeric characters).
Authenticate ID	Type the Authenticate ID (up to 64 alphanumeric characters).
Authenticate Password	Type the Authenticate Password (up to 64 alphanumeric characters).
Re-registration Interval (in seconds)*	Type the SIP Registration lease time in minutes (default is 60 minutes) (8 character limit). Re-registration Interval (in seconds)*
	Click the Save button to save your configuration settings. Note: You need to reboot for changes to take effect.
	Click on the Reboot button to reboot the system.

3. After changing the parameters, click on the **Save** button.

2.3.7 Configure the Multicast Parameters

1. Click on the **Multicast Configuration** button to open the **Multicast Configuration** page. See [Figure 2-19](#).

Figure 2-19. Multicast Configuration Setup

CyberData Ceiling Speaker

Home Device Config **Multicast Configuration** Networking SIP Config Nightringer Multicast Config Audio Config Clock Config Event Config Autoprovisioning Update Firmware

Enable Multicast operation:

Device Settings

priority	Address	port	Multicast Group Name	Buffered
9	239.168.3.10	11000	Emergency	
8	239.168.3.9	10000	MG8	<input type="checkbox"/>
7	239.168.3.8	9000	MG7	<input type="checkbox"/>
6	239.168.3.7	8000	MG6	<input type="checkbox"/>
5	239.168.3.6	7000	MG5	<input type="checkbox"/>
SIP calls are considered priority 4.5				
4	239.168.3.5	6000	MG4	<input type="checkbox"/>
3	239.168.3.4	5000	MG3	<input type="checkbox"/>
2	239.168.3.3	4000	MG2	<input type="checkbox"/>
1	239.168.3.2	3000	MG1	<input type="checkbox"/>
0	239.168.3.1	2000	Background Music	<input type="checkbox"/>

Port range can be from 2000-65535
 Ports must be odd numbers
 Priority 9 is the highest and 0 is the lowest
 A higher priority audio stream will always supercede a lower one
 Priority 9 streams will play at maximum volume

* You need to reboot for changes to take effect

Save Reboot

2. On the **Multicast Configuration** page, enter values for the parameters indicated in [Table 2-11](#).

Table 2-11. Multicast Configuration Parameters

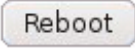
Web Page Item	Description
Enable Multicast Operation	Enables or disables multicast operation.
Device Settings	
Priority	Indicates the priority for the multicast group. Priority 9 is the highest (emergency streams). 0 is the lowest (background music). See Section 2.3.7.1, "Assigning Priority" for more details.
Address	Enter the multicast IP Address for this multicast group (15 character limit).
Port (range can be from 2000 to 65535)	Enter the port number for this multicast group (5 character limit). Note: The multicast ports have to be even values. The webpage will enforce this restriction.
Multicast Group Name	Assign a descriptive name for this multicast group (25 character limit).
Buffered	When buffering is enabled for a multicast stream, it will store any audio received on this socket to memory and play it back when the stream is stopped or the buffer is full.
	Click the Save button to save your configuration settings. Note: You need to reboot for changes to take effect.
	Click on the Reboot button to reboot the system.

3. After changing the parameters, click on the **Save** button.

2.3.7.1 Assigning Priority

When playing multicast streams, audio on different streams will preempt each other according to their priority in the list. An audio stream with a higher priority will interrupt a stream with a lower priority.

If both SIP and Multicast is enabled, SIP audio streams are considered priority **4.5**. SIP audio will interrupt multicast streams with priority **0** through **4** and will be interrupted by multicast streams with priority **5** through **9**.

During priority **9** multicast streams, the analog volume control is bypassed and the volume level is set to maximum.

Note SIP calls, buffered SIP calls, multicast streams, buffered multicast streams, ring tones, ringback tones, and nightring tones are all prioritized.

Ringtones and Nightringtones

Ringtones all play at the same priority level. This means that it is possible to have a nightring tone and a normal ringtone playing at the same time.

The maximum ringtone duration is 2 MB or about four minutes of ulaw audio.

- Lengthy Pages Concerning how lengthy pages are handled (where someone puts the phone down for 15 minutes), after the 2MB limit is reached, further data will be thrown away while the audio file is played back. When the file is done playing, it will stop throwing away input and begin buffering data for another four minutes.
- Therefore, with the buffered mode enabled on a stream playing background music, you will hear the following sequence of events:
1. Four minutes of silence.
 2. Music from 0:00 through 4:00.
 3. Four minutes of silence.
 4. Music from 8:00 through 12:00 and so on.
- Buffered Audio When the speaker is playing back buffered audio and this buffered audio is interrupted by a higher priority stream, once the higher priority streams is finished, the speaker will restart the lower priority stream from the beginning.

2.3.8 Configure the Audio Parameters

Click the **Audio Config** button to open the **Audio Configuration** page. See [Figure 2-20](#) and [Figure 2-21](#). The **Audio Configuration** page is used to add custom audio to the board. User uploaded audio will take precedence over the audio files shipped with the Intercom.

Figure 2-20. Audio Configuration Page

CyberData Ceiling Speaker

Audio Configuration

Available Space = 14.54MB

Audio Files

0: Currently set to default
New File:

1: Currently set to default
New File:

2: Currently set to default
New File:

3: Currently set to default
New File:

4: Currently set to default
New File:

5: Currently set to default
New File:

6: Currently set to default
New File:

7: Currently set to default
New File:

8: Currently set to default
New File:

9: Currently set to default
New File:

Figure 2-21. Audio Configuration Page (continued)

The screenshot displays a configuration page with a light blue background. It contains ten distinct sections, each for a different audio file. Each section is titled with a parameter name in bold, followed by the text "Currently set to default". Below each title is a "New File:" label, a text input field, and a "Browse..." button. At the bottom right of each section are three buttons: "Play", "Delete", and "Save".

- Dot:** Currently set to default. New File: [input] Browse... [Play] [Delete] [Save]
- Audio test:** Currently set to default. New File: [input] Browse... [Play] [Delete] [Save]
- Page tone:** Currently set to default. New File: [input] Browse... [Play] [Delete] [Save]
- Talk:** Currently set to default. New File: [input] Browse... [Play] [Delete] [Save]
- Listen:** Currently set to default. New File: [input] Browse... [Play] [Delete] [Save]
- Your IP Address is:** Currently set to default. New File: [input] Browse... [Play] [Delete] [Save]
- Rebooting:** Currently set to default. New File: [input] Browse... [Play] [Delete] [Save]
- Restoring Default:** Currently set to default. New File: [input] Browse... [Play] [Delete] [Save]
- Ringback tone:** Currently set to default. New File: [input] Browse... [Play] [Delete] [Save]
- Ring tone:** Currently set to default. New File: [input] Browse... [Play] [Delete] [Save]
- Night Ring:** Currently set to default. New File: [input] Browse... [Play] [Delete] [Save]

On the **Audio Configuration** page, enter values for the parameters indicated in [Table 2-12](#).

Note Each entry on the **Audio Configuration** page replaces one of the stock audio files on the board. When the input box displays the word **default**, the Talkback Speaker is using the stock audio file. If that file is replaced with a user file, it will display the uploaded filename.

Table 2-12. Audio Configuration Parameters



Web Page Item	Description
Audio Files	
0-9	The name of the audio configuration option is the same as the spoken audio that plays on the board (24 character limit). '0' corresponds to the spoken word "zero." '1' corresponds to the spoken word "one." '2' corresponds to the spoken word "two." '3' corresponds to the spoken word "three." '4' corresponds to the spoken word "four." '5' corresponds to the spoken word "five." '6' corresponds to the spoken word "six." '7' corresponds to the spoken word "seven." '8' corresponds to the spoken word "eight." '9' corresponds to the spoken word "nine."
Dot	Corresponds to the spoken word "dot." (24 character limit)
Audiotest	Corresponds to the message "This is the CyberData IP speaker test message..." (24 character limit)
Pagetone	Corresponds to a simple tone used for beep on initialization and beep on page (24 character limit).
Talk	While in Monitor Mode , the person at the phone will hear the word "talk" when they are switching from the "listening mode" to the "talking mode."
Listen	While in Monitor Mode , the person at the phone will hear the word "listen" when they are switching from the "talking mode" to the "listening mode."
Your IP Address is	Corresponds to the message "Your IP address is..." (24 character limit).
Rebooting	Corresponds to the spoken word "Rebooting" (24 character limit).
Restoring default	Corresponds to the message "Restoring default" (24 character limit).
Ringback Tone	This is the ringback tone that plays when calling a remote extension (24 character limit).
Ring Tone	This is the tone that plays when set to ring when receiving a call (24 character limit).
Night Ring	Specifies the ringtone for nightring. By default this parameter uses the same audio file that is selected for the Ring Tone parameter.
	The Browse button will allow you to navigate to and select an audio file.
	The Play button will play that audio file.

Table 2-12. Audio Configuration Parameters (continued)

Web Page Item	Description
	The Delete button will delete any user uploaded audio and restore the stock audio file.
	The Save button will download a new user audio file to the board once you've selected the file by using the Browse button. The Save button will delete any pre-existing user-uploaded audio files.

2.3.8.1 User-created Audio Files

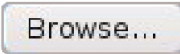
User created audio files should be saved in the following format:

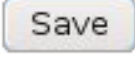
RIFF (little-endian) data, WAVE audio, Microsoft PCM, 16 bit, mono 8000 Hz

You can use the free utility *Audacity* to convert audio files into this format. See [Figure 2-22](#) through [Figure 2-24](#).

Figure 2-22. Audacity 1

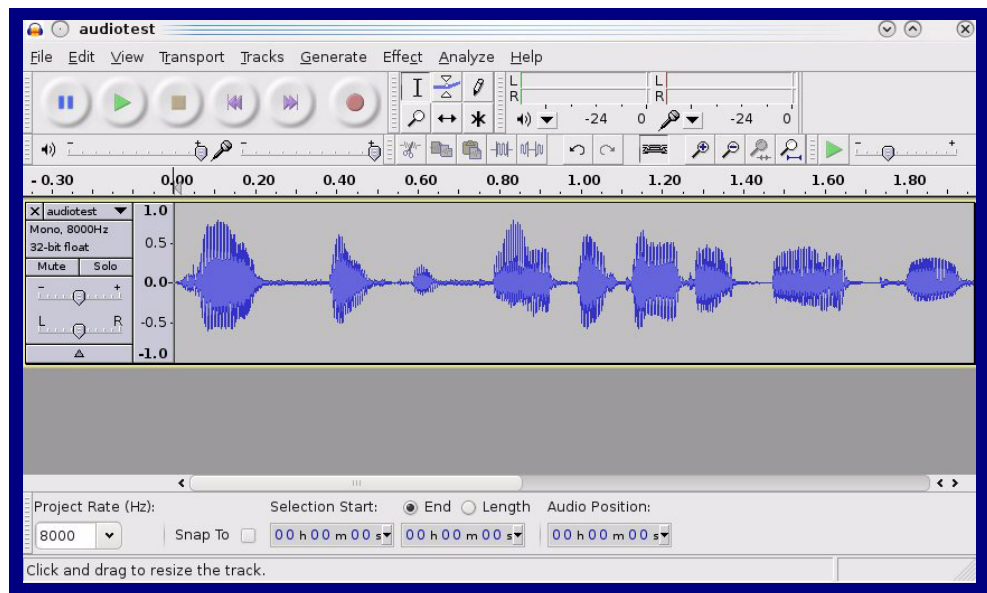
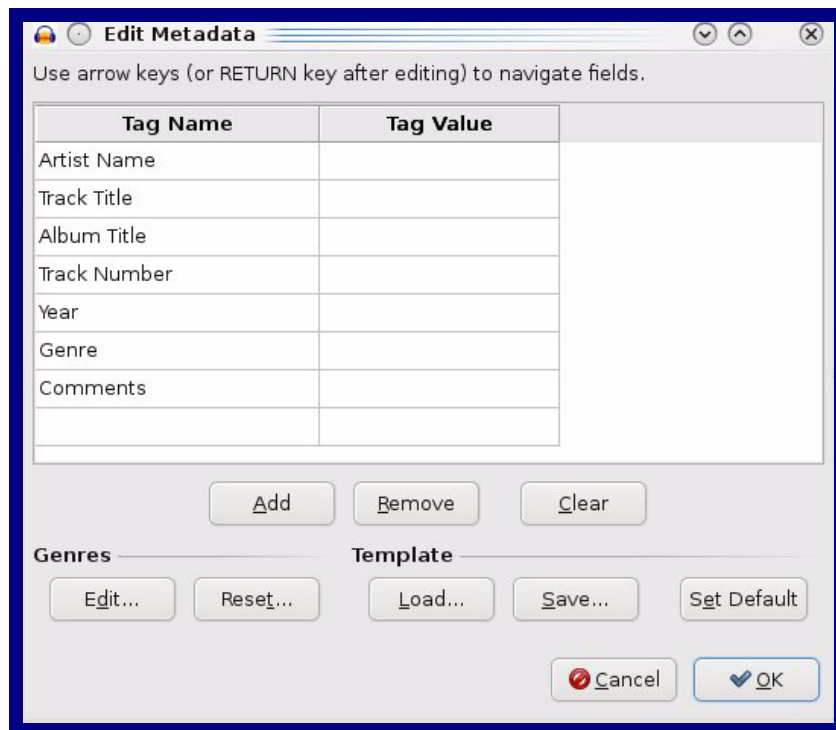

Figure 2-23. Audacity 2



When you export an audio file with Audacity, save the output as:

- **WAV (Microsoft) signed 16 bit PCM.**

Figure 2-24. WAV (Microsoft) signed 16 bit PCM

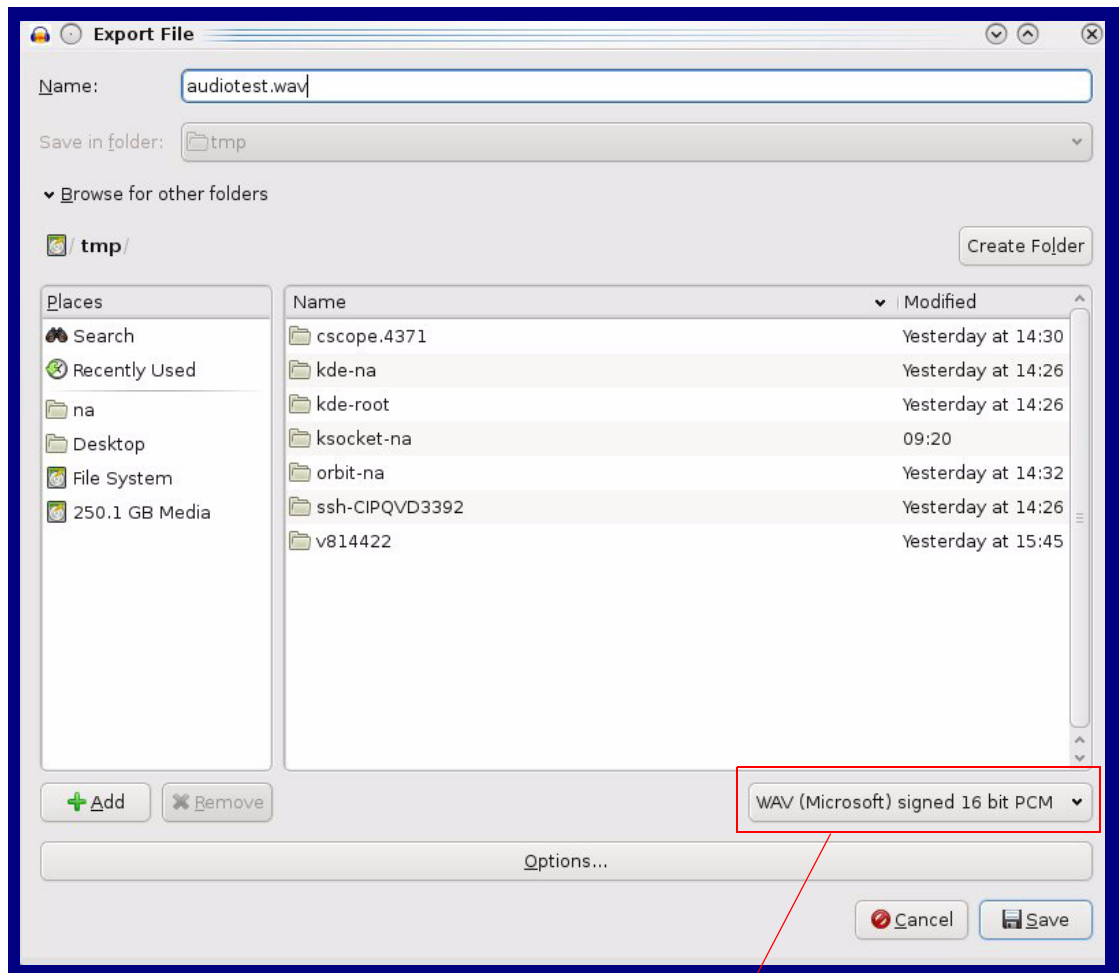

WAV (Microsoft) signed 16 bit PCM

2.3.9 Configure the NTP Server and Clock Parameters

Click the **Clock Config** button to open the **NTP Server and Clock Configuration** page.
See [Figure 2-25](#).

Note The **Clock Configuration** page is always visible. If a clock is not installed, the **Clock Status** will indicate **NOT INSTALLED**. Otherwise it shows **INSTALLED**.

Figure 2-25. NTP Server and Clock Configuration Page

The screenshot displays the 'NTP Server and Clock Configuration' page for a CyberData Ceiling Speaker. The page has a blue header with the product name and a left sidebar with navigation buttons: Home, Device Config, Networking, SIP Config, Nightringer, Multicast Config, Audio Config, Clock Config (highlighted), Event Config, Autoprovisioning, and Update Firmware. The main content area is titled 'NTP Server and Clock Configuration' and shows the following settings:



- Clock Status:** NOT INSTALLED
- Clock Firmware:** (empty field)
- NTP Settings:**
 - NTP Server:** north-america.pool.ntp.org
 - Posix Timezone String (see manual):** PST8PDT,M3.2.0/2:00:00,M11.1.0/2:00:01
 - Set Time with external NTP server on boot:**
 - Periodically update with time server:**
 - Time update period (in hours):** 24
 - Set time from NTP Server** (button)
- Clock Settings:**
 - Clock Brightness (0-14):** (slider)
 - Use Ambient Light Sensor:**
 - Clock Colon Type:** Off On Blink
 - Clock Time Format:** 12 Hour 24 Hour
- Current Time:**
 - Current Time in 24 hour format (HHMMSS):** (empty field)
 - Set Clock** (button)

* You need to reboot for changes to take effect

Save **Reboot** (buttons)

Table 2-13 shows the web page items on the NTP Server and Clock Configuration page.

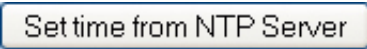
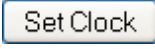
Table 2-13. NTP Server and Clock Configuration

Web Page Item	Description
Clock Status	Displays the current clock status.
Clock Firmware	Displays the current clock firmware version.
NTP Settings	
NTP Server	Allows you to select the NTP server (64 character limit).
Posix Time Zone String	See Section 2.3.9.1, "Time Zone Strings" (43 character limit).
Set Time with External NTP Server on boot	When selected, the time is set with an external NTP server when the speaker restarts.
Periodically update with time server	When selected, the time is periodically updated with a time server.
Time update period (in hours)	Allows you to select the time updated period (in hours) (4 character limit).
	Allows you to set the time from the NTP server.
Clock Settings	
Clock Brightness (0-14)	Allows you to select the clock brightness level (0-14) (2 character limit)
Use Ambient Light Sensor	Enables or disables the ambient light sensor.
Clock Colon Type	Allows you to select the clock colon type (Off , On , or Blink)
Clock Time Format	Allows you to select the clock format (12 or 24 hour)
Current Time	
Current Time in 24 hour format (HHMMSS)	Allows you to input the current time in the 24 hour format. (6 character limit)
	Click on this button to set the clock after entering the current time.
	Click the Save button to save your configuration settings. Note: You need to reboot for changes to take effect.
	Click on the Reboot button to reboot the system.

2.3.9.1 Time Zone Strings

The posix time zone string tells the internal date and time utilities how to handle daylight savings time for different time zones. [Table 2-14](#) shows some common strings.

Table 2-14. Common Time Zone Strings

Time Zone	Time Zone String
US Pacific time	PST8PDT,M3.2.0/2:00:00,M11.1.0/2:00:00
US Mountain time	MST7MDT,M3.2.0/2:00:00,M11.1.0/2:00:00
US Eastern Time	EST5EDT,M3.2.0/2:00:00,M11.1.0/2:00:00
Phoenix Arizona ^a	MST7
US Central Time	CST6DST,M3.2.0/2:00:00,M11.1.0/2:00:00

a. Phoenix, Arizona does not use daylight savings time.

[Table 2-15](#) shows a breakdown of the parts that constitute the following time zone string:

- ***CST6DST,M3.2.0/2:00:00,M11.1.0/2:00:00***

Table 2-15. Time Zone String Parts

Time Zone String Part	Meaning
CST6CDT	The time zone offset from GMT and three character identifiers for the time zone.
CST	Central Standard Time
6	The (hour) offset from GMT/UTC
CDT	Central Daylight Time
M3.2.0/2:00:00	The date and time when daylight savings begins.
M3	The third month (March)
.2	The 2nd occurrence of the day (next item) in the month
.0	Sunday
/2:00:00	Time of day to change
M11.1.0/2:00:00	The date and time when daylight savings ends.
M11	The eleventh month (November)
.1	The 1st occurrence of the day (next item) in the month
.0	Sunday
/2:00:00	Time of day to change

Time Zone String Examples [Table 2-16](#) has some more examples of time zone strings.

Table 2-16. Time Zone String Examples

Time Zone	Time Zone String
Tokyo ^a	IST-9
Berlin ^b	CET-1MET,M3.5.0/1:00,M10.5.0/1:00

- a. Tokyo does not use daylight savings time.
- b. For Berlin, daylight savings time starts on the last Sunday in March at 01:00 UTC, and ends on the last Sunday in October at 01:00 UTC, and is one hour ahead of UTC.

Time Zone Identifier A user-definable three or four character time zone identifier (such as PST, EDT, IST, MUT, etc) is needed at the beginning of the posix time zone string to properly set the time. However, the specific letters or numbers used for the time zone identifier are not important and can be any three or four letter or number combination that is chosen by the user. However, the time zone identifier cannot be blank.

Figure 2-26. Three or Four Character Time Zone Identifier

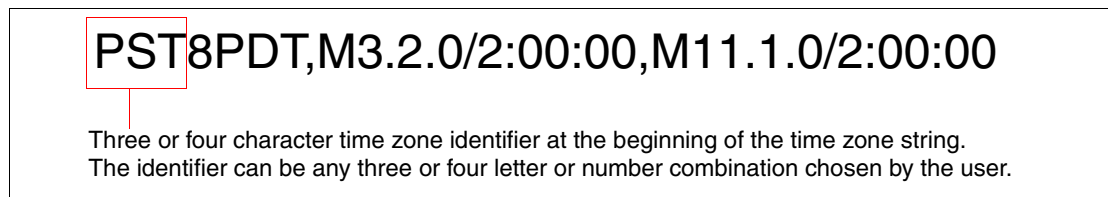

You can also use the following URL when a certain time zone applies daylight savings time:

<http://www.timeanddate.com/time/dst/2011.html>

World GMT Table [Table 2-17](#) has information about the GMT time in various time zones.

Table 2-17. World GMT Table

Time Zone	City or Area Zone Crosses
GMT-12	Eniwetok
GMT-11	Samoa
GMT-10	Hawaii
GMT-9	Alaska
GMT-8	PST, Pacific US
GMT-7	MST, Mountain US
GMT-6	CST, Central US
GMT-5	EST, Eastern US
GMT-4	Atlantic, Canada
GMT-3	Brazilia, Buenos Aries
GMT-2	Mid-Atlantic
GMT-1	Cape Verdes

Table 2-17. World GMT Table (continued)

Time Zone	City or Area Zone Crosses
GMT	Greenwich Mean Time, Dublin
GMT+1	Berlin, Rome
GMT+2	Israel, Cairo
GMT+3	Moscow, Kuwait
GMT+4	Abu Dhabi, Muscat
GMT+5	Islamabad, Karachi
GMT+6	Almaty, Dhaka
GMT+7	Bangkok, Jakarta
GMT+8	Hong Kong, Beijing
GMT+9	Tokyo, Osaka
GMT+10	Sydney, Melbourne, Guam
GMT+11	Magadan, Soloman Is.
GMT+12	Fiji, Wellington, Auckland

2.3.10 Configure the Event Parameters

Click the **Event Config** button to open the **Event Configuration** page (Figure 2-27). The **Event Configuration** page specifies a remote server that can be used to receive HTTP POST events when actions take place on the board.

Figure 2-27. Event Configuration Page

Table 2-18 shows the web page items on the **Event Configuration** page.

Table 2-18. Event Configuration

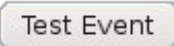
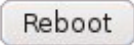
Web Page Item	Description
Enable Event Generation	When selected, Event Generation is enabled.
Remote Event Server	
Remote Event Server IP	Type the Remote Event Server IP address. (64 character limit)
Remote Event Server Port	Type the Remote Event Server port number. (8 character limit)
Remote Event Server URL	Type the Remote Event Server URL. (127 character limit)
Events	
Enable Button Events	When selected, Button Events are enabled.
Enable Call Active Events	When selected, Call Active Events are enabled.
Enable Call Terminated Events	When selected, Call Terminated Events are enabled.
Enable Monitor Call Active Events	When selected, Monitor Call Active Events are enabled.
Enable Monitor Call Terminated Events	When selected, Monitor Call Terminated Events are enabled.
Enable Relay Activated Events	When selected, Relay Activated Events are enabled.
Enable Relay Deactivated Events	When selected, Relay Deactivated Events are enabled.
Enable Ring Events	When selected, Ring Events are enabled.
Enable Night Ring Events	When selected, there is a notification when the speaker receives a night ring.
Enable Multicast Start Events	When selected, Multicast Start Events are enabled.
Enable Multicast Stop Events	When selected, Multicast Stop Events are enabled.
Enable Power On Events	When selected, Power On Events are enabled.
Enable 60 Second Heartbeat Events	When selected, 60 Second Heartbeat Events are enabled.
	Click the Save button to save your configuration settings. Note: You need to reboot for changes to take effect.
	Click on the Test Event button to test an event.
	Click on the Reboot button to reboot the system.

2.3.10.1 Example Packets for Events

The server and port are used to point to the listening server and the 'Remote Event Server URL' is the destination URL (typically the script running on the remote server that's used to parse and process the POST events).

Note The XML is URL-encoded before transmission so the following examples are not completely accurate.

Here are example packets for every event:

```
POST xmlparse_engine HTTP/1.1
Host: 10.0.3.79
User-Agent: CyberData/1.0.0
Content-Length: 197
Content-Type: application/x-www-form-urlencoded

<?xml version="1.0" encoding="ISO-8859-1"?>
<cyberdata NAME='CyberData VoIP Device' MAC='0020f70015b6'>
<event>POWERON</event>
</cyberdata>
```

```
POST xmlparse_engine HTTP/1.1
Host: 10.0.3.79
User-Agent: CyberData/1.0.0
Content-Length: 199
Content-Type: application/x-www-form-urlencoded

<?xml version="1.0" encoding="ISO-8859-1"?>
<cyberdata NAME='CyberData VoIP Device' MAC='0020f70015b6'>
<event>HEARTBEAT</event>
</cyberdata>
```

```
POST xmlparse_engine HTTP/1.1
Host: 10.0.3.79
User-Agent: CyberData/1.0.0
Content-Length: 201
Content-Type: application/x-www-form-urlencoded

<?xml version="1.0" encoding="ISO-8859-1"?>
<cyberdata NAME='CyberData VoIP Device' MAC='0020f70015b6'>
<event>CALL_ACTIVE</event>
</cyberdata>
```

```
POST xmlparse_engine HTTP/1.1
Host: 10.0.3.79
User-Agent: CyberData/1.0.0
Content-Length: 205
Content-Type: application/x-www-form-urlencoded

<?xml version="1.0" encoding="ISO-8859-1"?>
<cyberdata NAME='CyberData VoIP Device' MAC='0020f70015b6'>
<event>CALL_TERMINATED</event>
</cyberdata>
```

```
POST xmlparse_engine HTTP/1.1
```

```
Host: 10.0.3.79
User-Agent: CyberData/1.0.0
Content-Length: 197
Content-Type: application/x-www-form-urlencoded

<?xml version="1.0" encoding="ISO-8859-1"?>
<cyberdata NAME='CyberData VoIP Device' MAC='0020f70015b6'>
<event>RINGING</event>
</cyberdata>

POST xmlparse_engine HTTP/1.1
Host: 10.0.3.79
User-Agent: CyberData/1.0.0
Content-Length: 234
Content-Type: application/x-www-form-urlencoded

<?xml version="1.0" encoding="ISO-8859-1"?>
<cyberdata NAME='CyberData VoIP Device' MAC='0020f70015b6'>
<event>MULTICAST_START</event>
<index>8</index>
</cyberdata>

POST xmlparse_engine HTTP/1.1
Host: 10.0.3.79
User-Agent: CyberData/1.0.0
Content-Length: 233
Content-Type: application/x-www-form-urlencoded

<?xml version="1.0" encoding="ISO-8859-1"?>
<cyberdata NAME='CyberData VoIP Device' MAC='0020f70015b6'>
<event>MULTICAST_STOP</event>
<index>8</index>
</cyberdata>

POST xmlparse_engine HTTP/1.1
Host: 10.0.3.79
User-Agent: CyberData/1.0.0
Content-Length: 234
Content-Type: application/x-www-form-urlencoded
<?xml version="1.0" encoding="ISO-8859-1"?>
<cyberdata NAME='CyberData VoIP Device' MAC='0020f70015b6'>
<event>RELAY_ACTIVATED</event>
</cyberdata>
POST xmlparse_engine HTTP/1.1
Host: 10.0.3.79
User-Agent: CyberData/1.0.0
Content-Length: 234
Content-Type: application/x-www-form-urlencoded
<?xml version="1.0" encoding="ISO-8859-1"?>
<cyberdata NAME='CyberData VoIP Device' MAC='0020f70015b6'>
<event>RELAY_DEACTIVATED</event>
</cyberdata>

POST xmlparse_engine HTTP/1.1
Host: 10.0.3.79
User-Agent: CyberData/1.0.0
```

```
Content-Length: 234
Content-Type: application/x-www-form-urlencoded
<?xml version="1.0" encoding="ISO-8859-1"?>
<cyberdata NAME='CyberData VoIP Device' MAC='0020f70015b6'>
<event>NIGHTRINGING</event>
</cyberdata>
```

2.3.11 Configure the Autoprovisioning Parameters

1. Click the **Autoprovisioning** button to open the **Autoprovisioning Configuration** page.
See [Figure 2-28](#).

Figure 2-28. Autoprovisioning Configuration Page

CyberData Ceiling Speaker

Autoprovisioning

Autoprovisioning

Enable Autoprovisioning:

Get Autoprovisioning from DHCP:

Autoprovisioning Server (IP Address): 10.0.0.254

Autoprovisioning autoupdate (in minutes): 1440

* Autoprovisioning file name: 0020f700f0c4.config

* You need to reboot for changes to take effect

Save Reboot

2. On the **Autoprovisioning Configuration** page, you may enter values for the parameters indicated in [Table 2-19](#).

Table 2-19. Autoprovisioning Configuration Parameters

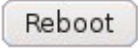
Web Page Item	Description
Autoprovisioning	
Enable Autoprovisioning	See Section 2.3.11.1, "Autoprovisioning" .
Get Autoprovisioning from DHCP	See Section 2.3.11.1, "Autoprovisioning" .
Autoprovisioning Server (IP Address)	See Section 2.3.11.1, "Autoprovisioning" (15 character limit).
Autoprovisioning Autoupdate (in minutes)	Type the desired time (in minutes) that you want the Autoprovisioning feature to update (6 character limit).
	Click the Save button to save your configuration settings. Note: You need to reboot for changes to take effect.
	Click on the Reboot button to reboot the system.

3. After changing the parameters, click the **Save** button.

2.3.11.1 Autoprovisioning

Enable Autoprovisioning Option With autoprovisioning enabled, the board will get its configuration from a remote TFTP server on startup or periodically on a scheduled delay. Autoprovisioned values will override values stored in on-board memory and will be visible on the web page. The board gets its autoprovisioning information from an XML-formatted file hosted from a TFTP server. CyberData will provide a template for this XML file and the user can modify it for their own use.

To use autoprovisioning, create a copy of the autoprovisioning template with the desired settings and name this file with the mac address of the device to configure (for example: **0020f7350058.config**). Put this file into your TFTP server directory and manually set the TFTP server address on the board.

It is not necessary to set every option found in the autoprovisioning template. As long as the XML is valid, the file can contain any subset. Options not autoprovisioned will default to the values stored in the on board memory. For example if you only wanted to modify the device name, the following would be a valid autoprovisioning file:

```
<?xml version="1.0" encoding="utf-8" ?>
<specific>
  <MiscSettings>
    <DeviceName>auto Ceiling Speaker</DeviceName>
  </MiscSettings>
</specific>
```

Networking The board will only apply networking settings or firmware upgrades after a reboot.

Get Autoprovisioning from DHCP When this option is checked, the device will automatically fetch its autoprovisioning server address from the DHCP server. The device will use the address specified in **OPTION 150** (TFTP-server-name) or **OPTION 66**. If both options are set, the device will use **OPTION 150**.

Refer to the documentation of your DHCP server for setting up **OPTION 150**.

To set up a Linux DHCPD server to serve autoprovisioning information (in this case using both option 66 and 150), here's an example dhcpd.conf:

```
# dhcpd.conf
#
# Configuration file for ISC dhcpd (see 'man dhcpd.conf')
#
ddns-update-style ad-hoc;

option option-150 code 150 = ip-address;

subnet 10.0.0.0 netmask 255.0.0.0 {
    max-lease-time 120;
    default-lease-time 120;

    option routers                10.0.0.1;
    option subnet-mask            255.0.0.0;

    option domain-name            "voiplab";
    option domain-name-servers    10.0.0.1;

    option time-offset            -8;      # Pacific Standard Time

    option tftp-server-name       "10.0.0.254";

    option option-150             10.0.0.254;

    range 10.10.0.1 10.10.2.1;}

```

Autoprovisioning Server (IP Address) Instead of using DHCP to provide the autoprovisioning tftp server address, you can specify an address manually.

Autoprovisioning Autoupdate If **Autoprovisioning** is enabled and the **Autoprovisioning Autoupdate** value is something other than 0 minutes, a service is started on startup that will wait the configured number of minutes and then try to re-download its autoprovisioning file. It will compare its previously autoprovisioned file with this new file and if there are differences, it will reboot the board.

Autoprovisioned Firmware Upgrades An Autoprovisioned firmware upgrade only happens after a reboot, will take roughly three minutes, and the web page will be unresponsive during this time.

The '**FirmwareVersion**' value in the xml file *must* match the version stored in the '**FirmwareFile**'.

```
<FirmwareVersion>v5.0.5b01</FirmwareVersion>
<FirmwareFile>505b01-uImage-ceilingSpeak</FirmwareFile>

```

If these values are mismatched, the board can get stuck in a loop where it goes through the following sequence of actions:

1. The board downloads and writes a new firmware file.
2. After the next reboot, the board recognizes that the firmware version does not match.
3. The board downloads and writes the firmware file again.

CyberData has timed a firmware upgrade at 140 seconds. Therefore, if you suspect the board is stuck in a loop, either remove or comment out the **FirmwareVersion** line in the XML file and let the board boot as it normally does.

Autoprovisioned Audio Files

Audio files are stored in non-volatile memory and an autoprovisioned audio file will only have to be downloaded once for each device. Loading many audio files to the device from the web page could cause it to appear unresponsive. If this happens, wait until the transfer is complete and then refresh the page.

The device uses the file name to determine when to download a new audio file. This means that if you used autoprovisioning to upload a file and then changed the contents of this file at the TFTP server, the device will not recognize that the file has changed (because the file name is the same).

Since audio files are stored in non-volatile memory, if autoprovisioning is disabled after they have been loaded to the board, the audio file settings will not change. You can force a change to the audio files on the board by clicking **Restore Default** on the **Audio Configuration** page or by changing the autoprovisioning file with **"default"** set as the file name.

2.3.12 Upgrade the Firmware and Reboot the Talkback Speaker

2.3.12.1 Upgrade the Firmware



Caution

When upgrading to firmware version 6.x.x from version 5.x.x or earlier, your device configuration settings will be lost because the way that the device stores the configuration settings is different in version 6.x.x.

To upload the firmware from your computer:

1. Retrieve the latest Talkback Speaker firmware from the VoIP V2 Speaker **Downloads** page at:
<http://www.cyberdata.net/products/voip/digitalanalog/ceilingspkr2ptt/downloads.html>
2. Unzip the Talkback Speaker version file. This file may contain the following:
 - Firmware file
 - Release notes
3. Log in to the Talkback Speaker home page as instructed in [Section 2.3.2, "Log in to the Configuration Home Page"](#).

4. Click the **Update Firmware** button to open the **Upgrade Firmware** page. See [Figure 2-29](#).

Figure 2-29. Upgrade Firmware Page

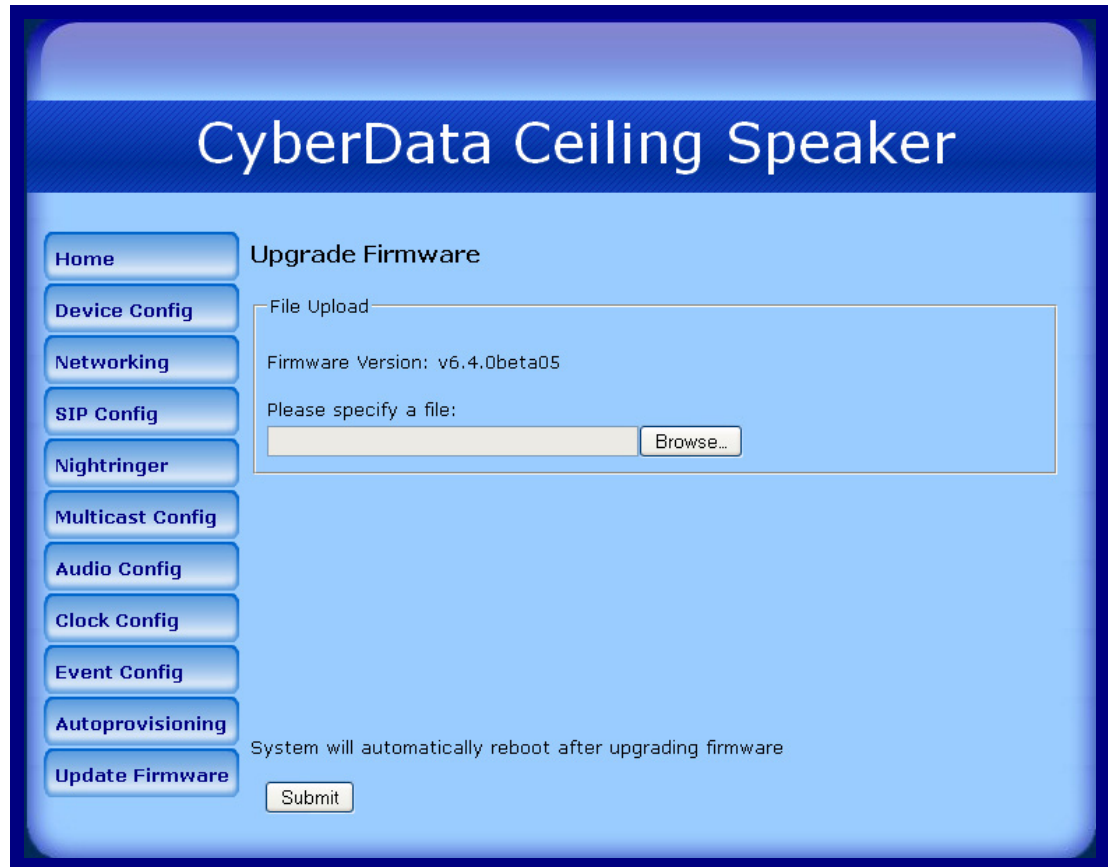



5. Click **Browse**, and then navigate to the location of the Talkback Speaker firmware file.
6. Click **Submit**.

Note This starts the upload process. Once the Talkback Speaker has uploaded the file, the **Uploading Firmware** countdown page appears, indicating that the firmware is being written to flash. The Talkback Speaker will automatically reboot when the upload is complete. When the countdown finishes, the **Upgrade Firmware** page will refresh. The uploaded firmware filename should be displayed in the system configuration (indicating successful upload and reboot).

Note The way that the integrity of the configuration file is validated has changed. There is no problem with updating the firmware but if you downgrade (or downgrade, make some changes, and then upgrade again) the device may think that the configuration is corrupt and restore defaults.

Table 2-20 shows the web page items on the **Upgrade Firmware** page.

Table 2-20. Upgrade Firmware Parameters

Web Page Item	Description
File Upload	
Firmware Version	Firmware Version
Please specify a file	Refer to the Browse button description.
	Use the Browse button to navigate to the location of the Intercom firmware file that you want to upload.
	Click on the Submit button to automatically upload the selected firmware and reboot the system.

2.3.12.2 Reboot the Talkback Speaker

To reboot a Talkback Speaker,

1. Log in to the **Home Page** as instructed in [Section 2.3.2, "Log in to the Configuration Home Page"](#). See [Figure 2-30](#).

Figure 2-30. Home Page



Reboot

2. Click the **Reboot** button. See [Figure 2-30](#).

3. A normal restart will occur and you will see the following **Reboot** page.

Figure 2-31. Reboot Page



2.4 Command Interface

Some functions on the device can be activated using simple POST commands to the web interface. The examples in [Table 2-21](#) use the free unix utility, **wget**, but any program that can send http POST commands to the device should work.

2.4.1 Command Interface Post Commands

Note These commands require an authenticated session (a valid username and password to work).

Table 2-21. Command Interface Post Commands

Device Action	HTTP Post Command ^a
Trigger relay (for configured delay)	wget --user admin --password admin --auth-no-challenge --quiet -O /dev/null "http://10.0.3.71/cgi-bin/command.cgi" --post-data "test_relay=yes"
Place call to extension (example: extension 130)	wget --user admin --password admin --auth-no-challenge --quiet -O /dev/null "http://10.0.3.71/cgi-bin/command.cgi" --post-data "call=130"
Terminate active call	wget --user admin --password admin --auth-no-challenge --quiet -O /dev/null "http://10.0.3.71/cgi-bin/command.cgi" --post-data "terminate=yes"
Force reboot	wget --user admin --password admin --auth-no-challenge --quiet -O /dev/null "http://10.0.3.71/cgi-bin/command.cgi" --post-data "reboot=yes"
Test Audio button	wget --user admin --password admin --auth-no-challenge --quiet -O /dev/null "http://10.0.3.71/cgi-bin/command.cgi" --post-data "test_audio=yes"
Announce IP address	wget --user admin --password admin --auth-no-challenge --quiet -O /dev/null "http://10.0.3.71/cgi-bin/command.cgi" --post-data "speak_ip_address=yes"
Play the "0" audio file	wget --user admin --password admin --auth-no-challenge --quiet -O /dev/null "http://10.0.3.71/cgi-bin/audioconfig.cgi" --post-data "play_0=yes"
Play the "1" audio file	wget --user admin --password admin --auth-no-challenge --quiet -O /dev/null "http://10.0.3.71/cgi-bin/audioconfig.cgi" --post-data "play_1=yes"
Play the "2" audio file	wget --user admin --password admin --auth-no-challenge --quiet -O /dev/null "http://10.0.3.71/cgi-bin/audioconfig.cgi" --post-data "play_2=yes"
Play the "3" audio file	wget --user admin --password admin --auth-no-challenge --quiet -O /dev/null "http://10.0.3.71/cgi-bin/audioconfig.cgi" --post-data "play_3=yes"
Play the "4" audio file	wget --user admin --password admin --auth-no-challenge --quiet -O /dev/null "http://10.0.3.71/cgi-bin/audioconfig.cgi" --post-data "play_4=yes"

Table 2-21. Command Interface Post Commands (continued)

Device Action	HTTP Post Command ^a
Play the "5" audio file	wget --user admin --password admin --auth-no-challenge --quiet -O /dev/null "http://10.0.3.71/cgi-bin/audioconfig.cgi" --post-data "play_5=yes"
Play the "6" audio file	wget --user admin --password admin --auth-no-challenge --quiet -O /dev/null "http://10.0.3.71/cgi-bin/audioconfig.cgi" --post-data "play_6=yes"
Play the "7" audio file	wget --user admin --password admin --auth-no-challenge --quiet -O /dev/null "http://10.0.3.71/cgi-bin/audioconfig.cgi" --post-data "play_7=yes"
Play the "8" audio file	wget --user admin --password admin --auth-no-challenge --quiet -O /dev/null "http://10.0.3.71/cgi-bin/audioconfig.cgi" --post-data "play_8=yes"
Play the "9" audio file	wget --user admin --password admin --auth-no-challenge --quiet -O /dev/null "http://10.0.3.71/cgi-bin/audioconfig.cgi" --post-data "play_9=yes"
Play the "Dot" audio file	wget --user admin --password admin --auth-no-challenge --quiet -O /dev/null "http://10.0.3.71/cgi-bin/audioconfig.cgi" --post-data "play_d=yes"
Play the "Audio Test" audio file (from Audio Config)	wget --user admin --password admin --auth-no-challenge --quiet -O /dev/null "http://10.0.3.71/cgi-bin/audioconfig.cgi" --post-data "play_audiotest=yes"
Play the "Page Tone" audio file	wget --user admin --password admin --auth-no-challenge --quiet -O /dev/null "http://10.0.3.71/cgi-bin/audioconfig.cgi" --post-data "play_pagetone=yes"
Play the "Your IP Address Is" audio file	wget --user admin --password admin --auth-no-challenge --quiet -O /dev/null "http://10.0.3.71/cgi-bin/audioconfig.cgi" --post-data "play_youripaddressis=yes"
Play the "Rebooting" audio file	wget --user admin --password admin --auth-no-challenge --quiet -O /dev/null "http://10.0.3.71/cgi-bin/audioconfig.cgi" --post-data "play_rebooting=yes"
Play the "Restoring Default" audio file	wget --user admin --password admin --auth-no-challenge --quiet -O /dev/null "http://10.0.3.71/cgi-bin/audioconfig.cgi" --post-data "play_restoringdefault=yes"
Play the "Ringback tone" audio file	wget --user admin --password admin --auth-no-challenge --quiet -O /dev/null "http://10.0.3.71/cgi-bin/audioconfig.cgi" --post-data "play_ringback=yes"
Play the "Ring tone" audio file	wget --user admin --password admin --auth-no-challenge --quiet -O /dev/null "http://10.0.3.71/cgi-bin/audioconfig.cgi" --post-data "play_ringtones=yes"
Play the "Intrusion Sensor Triggered" audio file	wget --user admin --password admin --auth-no-challenge --quiet -O /dev/null "http://10.0.3.71/cgi-bin/audioconfig.cgi" --post-data "play_intrusionsensortriggered=yes"
Play the "Door Ajar" audio file	wget --user admin --password admin --auth-no-challenge --quiet -O /dev/null "http://10.0.3.71/cgi-bin/audioconfig.cgi" --post-data "play_doorajar=yes"
Play the "Night Ring" audio file	wget --user admin --password admin --auth-no-challenge --quiet -O /dev/null "http://10.0.3.71/cgi-bin/audioconfig.cgi" --post-data "play_nightring=yes"

Table 2-21. Command Interface Post Commands (continued)

Device Action	HTTP Post Command ^a
Delete the "0" audio file	wget --user admin --password admin --auth-no-challenge --quiet -O /dev/null "http://10.0.3.71/cgi-bin/audioconfig.cgi" --post-data "delete_0=yes"
Delete the "1" audio file	wget --user admin --password admin --auth-no-challenge --quiet -O /dev/null "http://10.0.3.71/cgi-bin/audioconfig.cgi" --post-data "delete_1=yes"
Delete the "2" audio file	wget --user admin --password admin --auth-no-challenge --quiet -O /dev/null "http://10.0.3.71/cgi-bin/audioconfig.cgi" --post-data "delete_2=yes"
Delete the "3" audio file	wget --user admin --password admin --auth-no-challenge --quiet -O /dev/null "http://10.0.3.71/cgi-bin/audioconfig.cgi" --post-data "delete_3=yes"
Delete the "4" audio file	wget --user admin --password admin --auth-no-challenge --quiet -O /dev/null "http://10.0.3.71/cgi-bin/audioconfig.cgi" --post-data "delete_4=yes"
Delete the "5" audio file	wget --user admin --password admin --auth-no-challenge --quiet -O /dev/null "http://10.0.3.71/cgi-bin/audioconfig.cgi" --post-data "delete_5=yes"
Delete the "6" audio file	wget --user admin --password admin --auth-no-challenge --quiet -O /dev/null "http://10.0.3.71/cgi-bin/audioconfig.cgi" --post-data "delete_6=yes"
Delete the "7" audio file	wget --user admin --password admin --auth-no-challenge --quiet -O /dev/null "http://10.0.3.71/cgi-bin/audioconfig.cgi" --post-data "delete_7=yes"
Delete the "8" audio file	wget --user admin --password admin --auth-no-challenge --quiet -O /dev/null "http://10.0.3.71/cgi-bin/audioconfig.cgi" --post-data "delete_8=yes"
Delete the "9" audio file	wget --user admin --password admin --auth-no-challenge --quiet -O /dev/null "http://10.0.3.71/cgi-bin/audioconfig.cgi" --post-data "delete_9=yes"
Delete the "Audio Test" audio file	wget --user admin --password admin --auth-no-challenge --quiet -O /dev/null "http://10.0.3.71/cgi-bin/audioconfig.cgi" --post-data "delete_audiotest=yes"
Delete the "Page Tone" audio file	wget --user admin --password admin --auth-no-challenge --quiet -O /dev/null "http://10.0.3.71/cgi-bin/audioconfig.cgi" --post-data "delete_pagetone=yes"
Delete the "Your IP Address Is" audio file	wget --user admin --password admin --auth-no-challenge --quiet -O /dev/null "http://10.0.3.71/cgi-bin/audioconfig.cgi" --post-data "delete_youripaddressis=yes"
Delete the "Rebooting" audio file	wget --user admin --password admin --auth-no-challenge --quiet -O /dev/null "http://10.0.3.71/cgi-bin/audioconfig.cgi" --post-data "delete_rebooting=yes"
Delete the "Restoring Default" audio file	wget --user admin --password admin --auth-no-challenge --quiet -O /dev/null "http://10.0.3.71/cgi-bin/audioconfig.cgi" --post-data "delete_restoringdefault=yes"
Delete the "Ringback tone" audio file	wget --user admin --password admin --auth-no-challenge --quiet -O /dev/null "http://10.0.3.71/cgi-bin/audioconfig.cgi" --post-data "delete_ringback=yes"





Table 2-21. Command Interface Post Commands (continued)

Device Action	HTTP Post Command ^a
Delete the "Ring tone" audio file	wget --user admin --password admin --auth-no-challenge --quiet -O /dev/null "http://10.0.3.71/cgi-bin/audioconfig.cgi" --post-data "delete_ringtones=yes"
Delete the "Intrusion Sensor Triggered" audio file	wget --user admin --password admin --auth-no-challenge --quiet -O /dev/null "http://10.0.3.71/cgi-bin/audioconfig.cgi" --post-data "delete_intrusionsensortriggered=yes"
Delete the "Door Ajar" audio file	wget --user admin --password admin --auth-no-challenge --quiet -O /dev/null "http://10.0.3.71/cgi-bin/audioconfig.cgi" --post-data "delete_doorajar=yes"
Delete the "Night Ring" audio file	wget --user admin --password admin --auth-no-challenge --quiet -O /dev/null "http://10.0.3.71/cgi-bin/audioconfig.cgi" --post-data "delete_nightring=yes"
Trigger the Door Sensor Test (Sensor Config page)	wget --user admin --password admin --auth-no-challenge --quiet -O /dev/null "http://10.0.3.71/cgi-bin/sensorconfig.cgi" --post-data "doortest=yes"
Trigger the Intrusion Sensor Test (Sensor Config page)	wget --user admin --password admin --auth-no-challenge --quiet -O /dev/null "http://10.0.3.71/cgi-bin/sensorconfig.cgi" --post-data "intrusiontest=yes"

a. Type and enter all of each http POST command on one line.

Appendix A: Mounting the Speaker

A.1 Important Safety Instructions

 <p>GENERAL ALERT</p>	<p>Warning <i>Electrical Hazard:</i> The VoIP V2 Speaker enclosure is not rated for any AC voltages.</p>
 <p>GENERAL ALERT</p>	<p>Warning <i>Electrical Hazard:</i> This product should be installed by a licensed electrician according to all local electrical and building codes.</p>
 <p>GENERAL ALERT</p>	<p>Warning <i>Electrical Hazard:</i> To prevent injury, this apparatus must be securely attached to the floor/wall in accordance with the installation instructions.</p>
 <p>GENERAL ALERT</p>	<p>Warning The PoE connector is intended for intra-building connections only and does not route to the outside plant.</p>

A.2 Mount the Speaker

Before you mount the speaker, make sure that you have received all the parts for each speaker. Refer to [Table A-1](#) and [Table A-2](#).

Table A-1. Drop Ceiling Mounting Components (Part of the Accessory Kit)





Quantity	Part Name	Illustration
3	#8 Nylon Thumb Nuts	
3	#8 Fender Washers	
3	8-32 x 1 1/4" Mounting Screws	

Table A-2. Drywall Mounting Components (Part of the Accessory Kit)

Quantity	Part Name	Illustration
3	Plastic Ribbed Anchors	
3	#8 Sheet Metal Screws	

To mount the speaker:

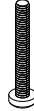
1. Use the **TEMPLATE** to cut the speaker hole and prepare holes for the screws (**Figure A-1**). This template is located on the back page of the *Installation Quick Reference Guide* that is delivered with each speaker.

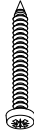
Figure A-1. VoIP Speaker Assembly

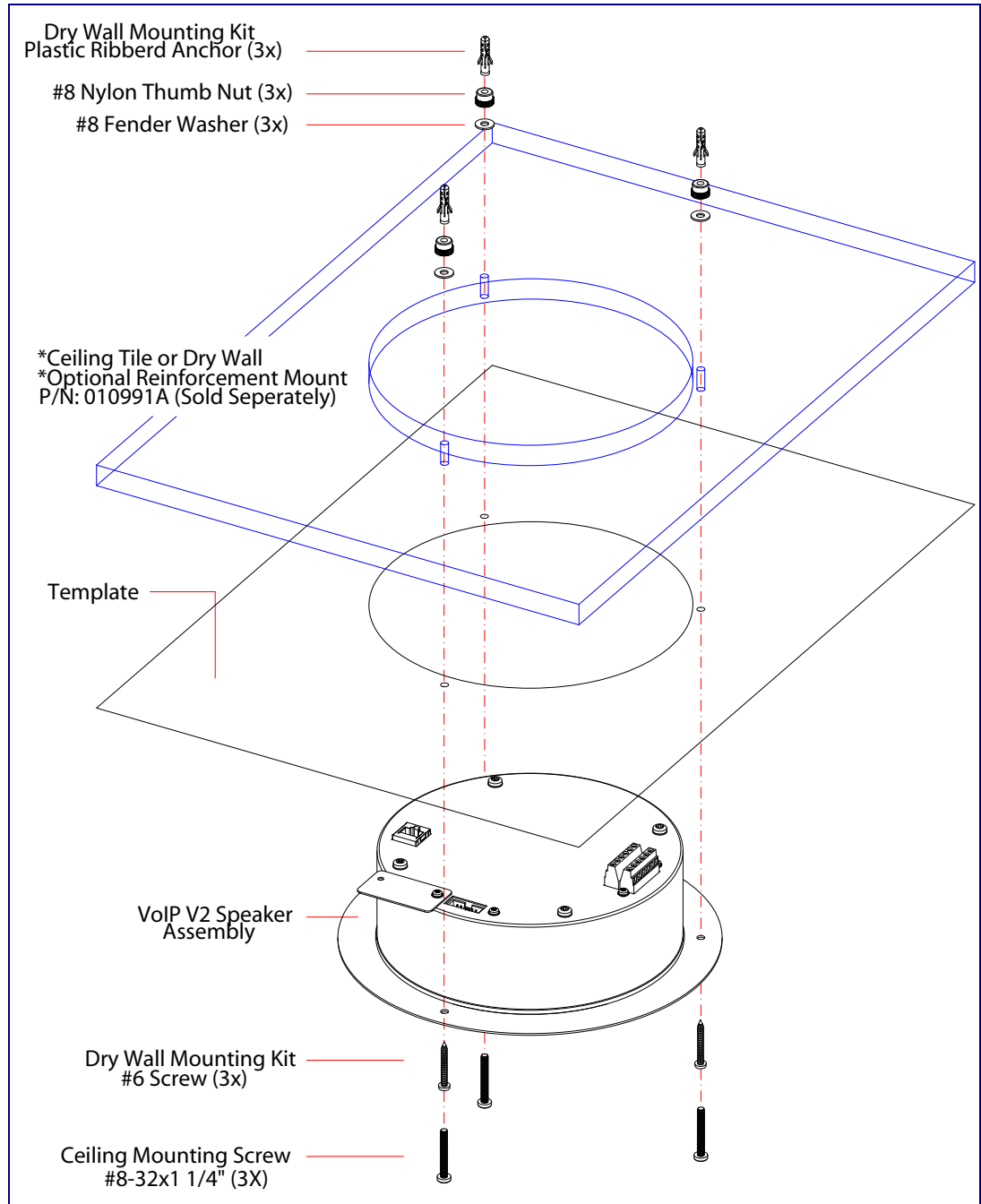

2. Plug the Ethernet cable into the Speaker Assembly. [Section 2.2.3, "Confirm that the Speaker is Operational and Linked to the Network"](#) explains how the **Link** and **Status** LEDs work.
3. At this point:
 - For *drop ceiling mounting*, position the **VoIP SPEAKER ASSEMBLY** in the ceiling so that its screw holes align with those you prepared.
 - For *drywall mounting*, place the three **PLASTIC RIBBED ANCHORS** in the holes you prepared, and position the **VoIP SPEAKER ASSEMBLY** over them, aligning the screw holes in the assembly with the anchors.
4. To fasten the speaker:
 - For *drop ceiling mounting*, use the three **8-32 x 1 1/4" MOUNTING SCREWS, #8 NYLON THUMB NUTS**, and **#8 FENDER WASHERS** to secure the speaker.

Note For weak ceiling tile, CyberData offers a reinforcing mount (CyberData part number 010991A).

- For *drywall mounting*, use the three **#8 SHEET METAL SCREWS** to secure the speaker.

Appendix B: Setting up a TFTP Server

B.1 Set up a TFTP Server

Autoprovisioning requires a TFTP server for hosting the configuration file.

B.1.1 In a LINUX Environment

To set up a TFTP server on LINUX:

1. Create a directory dedicated to the TFTP server, and move the files to be uploaded to that directory.
2. Run the following command where `/tftpbboot/` is the path to the directory you created in [Step 1](#): the directory that contains the files to be uploaded. For example:

```
in.tftpd -l -s /tftpbboot/your_directory_name
```

B.1.2 In a Windows Environment

You can find several options online for setting up a Windows TFTP server. This example explains how to use the Solarwinds freeware TFTP server, which you can download at:

<http://www.cyberdata.net/support/voip/solarwinds.html>

To set up a TFTP server on Windows:

1. Install and start the software.
2. Select **File/Configure/Security** tab/**Transmit Only**.
3. Make a note of the default directory name, and then move the firmware files to be uploaded to that directory.

Appendix C: Troubleshooting/Technical Support

C.1 Frequently Asked Questions (FAQ)

To see a list of frequently asked questions for your product, go to the following URL:

<http://www.cyberdata.net/products/voip/digitalanalog/ceilingspkr2ptt/faqs.html>

C.2 Documentation

The documentation for this product is released in an English language version only. You can download PDF copies of CyberData product documentation by going to the following URL:

<http://www.cyberdata.net/products/voip/digitalanalog/ceilingspkr2ptt/docs.html>

C.3 Contact Information

Contact	<p>CyberData Corporation 3 Justin Court Monterey, CA 93940 USA www.CyberData.net Phone: 800-CYBERDATA (800-292-3732) Fax: 831-373-4193</p>
Sales	<p>Sales 831-373-2601 Extension 334</p>
Technical Support	<p>The fastest way to get technical support for your VoIP product is to submit a VoIP Technical Support form at the following website:</p> <p>http://www.cyberdata.net/support/contactsupportvoip.html</p> <p>We have several technical support staff monitoring this form and they will contact you within 12 hours after receiving a form submission.</p> <p>Phone: (831) 373-2601, Ext. 333 Email: support@cyberdata.net</p>
Returned Materials Authorization	<p>To return the product, contact the Returned Materials Authorization (RMA) department:</p> <p>Phone: 831-373-2601, Extension 136 Email: RMA@CyberData.net</p> <p>When returning a product to CyberData, an approved CyberData RMA number must be printed on the outside of the original shipping package. No product will be accepted for return without an approved RMA number. Send the product, in its original package, to the following address:</p> <p>CyberData Corporation 3 Justin Court Monterey, CA 93940 Attention: RMA "your RMA number"</p>
RMA Status Form	<p>If you need to inquire about the repair status of your product(s), please use the CyberData RMA Status form at the following web address:</p> <p>http://www.cyberdata.net/support/rmastatus.html</p>

C.4 Warranty

CyberData warrants its product against defects in material or workmanship for a period of two years from the date of purchase. Should the product fail within the warranty period, CyberData will repair or replace the product free of charge. This warranty includes all parts and labor.

Should the product fail out-of-warranty, a flat rate repair charge of one half of the purchase price of the product will be assessed. Repairs that are in warranty but are damaged by improper modifications or abuse, will be charged at the out-of-warranty rate. Products shipped to CyberData, both in and out-of-warranty, are shipped at the expense of the customer. Shipping charges for repaired products shipped back to the customer by CyberData, will be paid by CyberData.

CyberData shall not under any circumstances be liable to any person for any special, incidental, indirect or consequential damages, including without limitation, damages resulting from use or malfunction of the products, loss of profits or revenues or costs of replacement goods, even if CyberData is informed in advance of the possibility of such damages.

C.4.1 Warranty & RMA Returns within the United States

If service is required, you must contact CyberData Technical Support prior to returning any products to CyberData. Our Technical Support staff will determine if your product should be returned to us for further inspection. If Technical Support determines that your product needs to be returned to CyberData, an RMA number will be issued to you at this point.

Your issued RMA number must be printed on the outside of the shipping box. No product will be accepted for return without an approved RMA number. The product in its original package should be sent to the following address:

CyberData Corporation
3 Justin Court.
Monterey, CA 93940
Attn: RMA "xxxxxx"

C.4.2 Warranty & RMA Returns Outside of the United States

If you purchased your equipment through an authorized international distributor or reseller, please contact them directly for product repairs.

C.4.3 Spare in the Air Policy

CyberData now offers a *Spare in the Air* no wait policy for warranty returns within the United States and Canada. More information about the *Spare in the Air* policy is available at the following web address:

<http://www.cyberdata.net/support/warranty/spareintheair.html>

C.4.4 Return and Restocking Policy

For our authorized distributors and resellers, please refer to your CyberData Service Agreement for information on our return guidelines and procedures.

For End Users, please contact the company that you purchased your equipment from for their return policy.

C.4.5 Warranty and RMA Returns Page

The most recent warranty and RMA information is available at the CyberData Warranty and RMA Returns Page at the following web address:

<http://www.cyberdata.net/support/warranty/index.html>

Index

Symbols

#8 fender washers 76, 78
 #8 nylon thumb nuts 76, 78
 #8 sheet metal screws 76, 78

Numerics

8-32 x 1 1/4" mounting screws 76, 78

A

AC voltages 2
 AC voltages, intercom enclosure is not rated 75
 address, configuration login 27
 adjusting volume 24
 ambient operating temperature 5
 analog speaker
 analog volume control needs to be disabled 18
 announcing a speaker's IP address 22, 24
 audio (buffered) 44
 audio configuration 45
 night ring tone parameter 47
 audio configuration page 45
 audio output 5
 audio sensitivity 5
 audio test 22, 24
 autoprovisioning 63
 autoprovisioned audio files 65
 autoprovisioned firmware upgrades 64
 autoprovisioning autoupdate 64
 autoprovisioning enabled option 63
 autoprovisioning from DHCP 63
 autoprovisioning server (IP address) 64
 networking 63
 autoprovisioning configuration 61, 62

B

backup SIP server 1 37
 backup SIP server 2 37
 backup SIP servers, SIP server
 backups 37
 buffered audio 44

C

changing
 the web access password 30
 clock configuration 51, 52
 clock configuration page 51
 clock status 51
 command interface 71
 commands 71
 configurable parameters 29, 31, 34
 configuration
 clock 51
 default IP settings 25
 device 12
 NTP Server 51
 SIP 35
 using Web interface 25
 configuration home page 28
 configuration page
 configurable parameters 31
 confirming IP address 22, 24
 contact information 81
 contact information for CyberData 81
 Current Network Settings 34
 current network settings 34
 CyberData contact information 81

D

default
 gateway 12, 25
 IP address 12, 25
 subnet mask 12, 25
 username and password 12, 25
 web login username and password 28
 default gateway 12, 25, 34
 default IP settings 25
 default login address 27
 device configuration 12, 30
 device configuration parameters 62
 the device configuration page 61
 device configuration page 30
 device configuration parameters 31
 device configuration password
 changing for web configuration access 30
 DHCP IP addressing 34
 dial out extension strings 39
 dimensions 5, 6
 discovery utility program 27
 DNS server 34

door sensor 47
 downgrading (may restore factory defaults) 67
 drop ceiling mounting of speaker 78
 drywall mounting of speaker 78
 DTMF tones 39
 DTMF tones (using rfc2833) 39

E

enable night ring events 51, 57
 Ethernet cable 78
 ethernet port baud rate 5
 event configuration
 enable night ring events 57
 expiration time for SIP server lease 38, 41

F

factory default settings
 how to set 24
 features 3
 firmware
 downgrading (may restore factory defaults) 67
 where to get the latest firmware 66
 firmware upgrade parameters 68

G

GMT table 54
 GMT time 54

H

home page 28
 http POST command 71

I

identifier names (PST, EDT, IST, MUT) 54
 identifying your product 1
 illustration of speaker mounting process 76
 installation, typical speaker system 2
 IP address 12, 25, 34
 IP addressing 34
 default
 IP addressing setting 12, 25

L

lease, SIP server expiration time 38, 41
 lengthy pages 43
 link LED 78
 Linux, setting up a TFTP server on 79
 local SIP port 38
 log in address 27

M

MGROUP
 MGROUP Name 43
 monitor mode 9
 monitor SIP
 user ID 37
 monitor SIP configuration parameters
 monitor user ID, SIP 37
 monitor SIP server
 monitor user ID for login 37
 password for login 37
 monitor user ID
 for SIP server login 37
 mounting a speaker 76
 multicast configuration 42
 Multicast IP Address 43

N

navigation (web page) 26
 navigation table 26
 network link activity, verifying 21
 nightring tones 43
 nightringer settings 41
 normal mode 7
 NTP server 52
 NTP Server configuration 51

O

overview 1

P

pages (lengthy) 43
 parts
 #8 fender washers 76
 #8 nylon thumb nuts 76

- #8 sheet metal screws 76
- 8-32 x 1 1/4" mounting screws 76
- plastic ribbed anchors 76
- password
 - for monitor SIP server login 37
 - for SIP server login 37
 - login 28
 - restoring the default 12, 25
- plastic ribbed anchors 76, 78
- port
 - local SIP 38
 - remote SIP 38
- POST command 71
- power input (J1) 5
- power requirement 5
- power, connecting to speaker 13
- priority
 - assigning 43
- product
 - configuring 25
 - mounting 76
 - parts list 11
- product features 3
- product overview 1
 - product features 3
 - product specifications 5
- product specifications 5

R

- reboot 68, 69
- remote SIP port 38
- Reset Test Function Management (RTFM) button 22, 24
- restoring the factory default settings 24
- return and restocking policy 83
- ringtones 43
 - lengthy pages 43
- RMA returned materials authorization 81
- RMA status 81
- RTFM button 22, 24

S

- sales 81
- server address, SIP 37
- service 81
- SIP
 - enable SIP operation 37
 - local SIP port 38
 - user ID 37
- SIP configuration 35
 - SIP Server 37

- SIP configuration parameters 37
 - outbound proxy 38
 - registration and expiration, SIP server lease 38, 41
 - unregister on reboot 38
 - user ID, SIP 37
- SIP registration 38
- SIP remote SIP port 38
- SIP server 37
 - password for login 37
 - unregister from 38
 - user ID for login 37
- SIP settings 37, 38
- Spare in the Air Policy 82
- speaker configuration
 - default IP settings 25
- speaker configuration page
 - configurable parameters 29, 34
- speaker operations, verifying 30
- static IP addressing 34
- status LED 78
- Stored Network Settings 34
- subnet mask 12, 25, 34

T

- tech support 81
- technical support, contact information 81
- template for speaker and screw holes 77
- testing audio 22, 24
- TFTP server 79
- time zone string examples 54
- time zone strings 53
- typical system installation 2

U

- user ID
 - for SIP server login 37
- username
 - changing for web configuration access 30
 - default for web configuration access 28
 - restoring the default 12, 25

V

- verifying
 - network link and activity 21
 - power on to speaker 21
 - speaker operations 30
- VoIP speaker assembly 78
- volume boost 31

volume, adjusting 24

W

warranty 82
warranty & RMA returns outside of the United States 82
warranty & RMA returns within the United States 82
warranty and RMA returns page 83
warranty policy at CyberData 82
web access password 12, 25
web access username 12, 25
web configuration log in address 27
web page
 navigation 26
web page navigation 26
web-based speaker configuration 25
weight 5
wget, free unix utility 71
Windows, setting up a TFTP server on 79