



## Ultra-elegant Gigabit IP Phone SIP-T46G User Guide

# Copyright

**Copyright © 2014 YEALINK NETWORK TECHNOLOGY CO., LTD.**

Copyright © 2014 Yealink Network Technology CO., LTD. All rights reserved. No parts of this publication may be reproduced or transmitted in any form or by any means, electronic or mechanical, photocopying, recording, or otherwise, for any purpose, without the express written permission of Yealink Network Technology CO., LTD. Under the law, reproducing includes translating into another language or format.

When this publication is made available on media, Yealink Network Technology CO., LTD. gives its consent to downloading and printing copies of the content provided in this file only for private use but not for redistribution. No parts of this publication may be subject to alteration, modification or commercial use. Yealink Network Technology CO., LTD. will not be liable for any damages arising from use of an illegally modified or altered publication.

## Warranty

THE SPECIFICATIONS AND INFORMATION REGARDING THE PRODUCTS IN THIS GUIDE ARE SUBJECT TO CHANGE WITHOUT NOTICE. ALL STATEMENTS, INFORMATION, AND RECOMMENDATIONS IN THIS GUIDE ARE BELIEVED TO BE ACCURATE AND PRESENTED WITHOUT WARRANTY OF ANY KIND, EXPRESS OR IMPLIED. USERS MUST TAKE FULL RESPONSIBILITY FOR THEIR APPLICATION OF PRODUCTS.

YEALINK NETWORK TECHNOLOGY CO., LTD. MAKES NO WARRANTY OF ANY KIND WITH REGARD TO THIS GUIDE, INCLUDING, BUT NOT LIMITED TO, THE IMPLIED WARRANTIES OF MERCHANTABILITY AND FITNESS FOR A PARTICULAR PURPOSE. Yealink Network Technology CO., LTD. shall not be liable for errors contained herein nor for incidental or consequential damages in connection with the furnishing, performance, or use of this guide.

## Declaration of Conformity



Hereby, Yealink Network Technology CO., LTD. declares that this phone is in conformity with the essential requirements and other relevant provisions of the CE, FCC.

## CE Mark Warning

This device is marked with the CE mark in compliance with EC Directives 2006/95/EC and 2004/108/EC.

## Part 15 FCC Rules

This device is compliant with Part 15 of the FCC Rules. Operation is subject to the following two conditions:

1. This device may not cause harmful interference.
2. This device must accept any interference received, including interference that may cause undesired operation.

## Class B Digital Device or Peripheral

Note: This equipment has been tested and found to comply with the limits for a Class B digital device, pursuant to part 15 of the FCC Rules. These limits are designed to provide reasonable protection against harmful interference in a residential installation. This equipment generates, uses and can radiate radio frequency energy and, if not installed and used in accordance with the instructions, may cause harmful interference to radio communications. However, there is no guarantee that interference will not occur in a particular installation. If this equipment does cause harmful interference to radio or television reception, which can be determined by turning the equipment off and on, the user is encouraged to try to correct the interference by one or more of the following measures:

1. Reorient or relocate the receiving antenna.
2. Increase the separation between the equipment and receiver.
3. Connect the equipment into an outlet on a circuit different from that to which the receiver is connected.
4. Consult the dealer or an experienced radio/TV technician for help.

## WEEE Warning



To avoid the potential effects on the environment and human health as a result of the presence of hazardous substances in electrical and electronic equipment, end users of electrical and electronic equipment should understand the meaning of the crossed-out wheeled bin symbol. Do not dispose of WEEE as unsorted municipal waste and have to collect such WEEE separately.

## Customer Feedback

We are striving to improve our documentation quality and we appreciate your feedback. Email your opinions and comments to [DocsFeedback@yealink.com](mailto:DocsFeedback@yealink.com).

# GNU GPL INFORMATION

Yealink SIP-T46G IP phone firmware contains third-party software under the GNU General Public License (GPL). Yealink uses software under the specific terms of the GPL. Please refer to the GPL for the exact terms and conditions of the license.

The original GPL license, source code of components licensed under GPL and used in Yealink products can be downloaded online:

<http://www.yealink.com/GPLOpenSource.aspx?BaseInfoCatId=293&NewsCatId=293&CatId=293>.



## About This Guide

Thank you for choosing the SIP-T46G IP Phone, an ultra-elegant gigabit IP Phone which is exquisitely designed to provide business telephony features, such as Call Hold, Call Transfer, Busy Lamp Field, Multicast Paging and Conference over an IP network.

This guide provides everything you need to quickly use your new phone. First, verify with your system administrator that the IP network is ready for phone configuration. Also be sure to read the Packaging Contents and Regulatory Notices sections in this guide before you set up and use the SIP-T46G IP phone.

**Note**

Shared Line, Network Directory and Network Call Log features are hidden for IP phones in neutral firmware version, which are designed for the BroadWorks environment. Please contact your system administrator for more information.

## In This Guide

Topics provided in this guide include:

- Chapter 1 [Overview](#)
- Chapter 2 [Getting Started](#)
- Chapter 3 [Customizing Your Phone](#)
- Chapter 4 [Basic Call Features](#)
- Chapter 5 [Advanced Phone Features](#)

## Summary of Changes

This section describes the changes to this guide for each release and guide version.

### Changes for Release 73, Guide Version 73.40

The following section is new:

- [Optional Accessories](#) on page 10

Major updates have occurred to the following sections:

- [DSS Keys](#) on page 62
- [Appendix A - Time Zones](#) on page 165

## Changes for Release 73, Guide Version 73.16

The following sections are new:

- [BLF List](#) on page 127

Major updates have occurred to the following sections:

- [Icon Instructions](#) on page 3
- [Ring Tones](#) on page 32
- [Anonymous Call Rejection](#) on page 122
- [Multicast Paging](#) on page 136
- [Troubleshooting](#) on page 153
- [Appendix A - Time Zones](#) on page 165

## Changes for Release 72, Guide Version 72.2

Major updates have occurred to the following sections:

- [Documentations](#) on page 8
- [Packaging Contents](#) on page 9

## Changes for Release 72, Guide Version 72.1

Major updates have occurred to the following sections:

- [LED Instructions](#) on page 4
- [Backlight](#) on page 22
- [Contrast](#) on page 23
- [Anonymous Call](#) on page 121

## Changes for Release 71, Guide Version 71.180

Major updates have occurred to the following sections:

- [Line Keys](#) on page 62
- [Hot Desking](#) on page 131
- [Troubleshooting](#) on page 153
- [Appendix A - Time Zones](#) on page 165

## Changes for Release 71, Guide Version 71.150

Major updates have occurred to the following sections:

- [Bluetooth Headset](#) on page 57
- [Remote Phone Book](#) on page 51
- [Line Keys](#) on page 62
- [Anonymous Call](#) on page 121
- [Troubleshooting](#) on page 153
- [Appendix A - Time Zones](#) on page 165



# Table of Contents

<b>About This Guide .....</b>	<b>v</b>
In This Guide .....	v
Summary of Changes.....	v
Changes for Release 73, Guide Version 73.40 .....	v
Changes for Release 73, Guide Version 73.16 .....	vi
Changes for Release 72, Guide Version 72.2 .....	vi
Changes for Release 72, Guide Version 72.1 .....	vi
Changes for Release 71, Guide Version 71.180 .....	vi
Changes for Release 71, Guide Version 71.150 .....	vii
<b>Table of Contents.....</b>	<b>ix</b>
<b>Overview .....</b>	<b>1</b>
Hardware Component Instructions.....	1
Icon Instructions .....	3
LED Instructions .....	4
User Interfaces.....	6
Phone User Interface .....	6
Web User Interface.....	6
Documentations.....	8
<b>Getting Started.....</b>	<b>9</b>
Packaging Contents.....	9
Optional Accessories.....	10
Phone Installation.....	11
Phone Initialization.....	14
Phone Status.....	15
Basic Network Settings.....	16
Registration .....	18
Idle Screen .....	18
<b>Customizing Your Phone .....</b>	<b>21</b>
General Settings.....	21
Wallpaper .....	21
Backlight.....	22
Contrast.....	23

Language.....	24
Time & Date.....	25
Administrator Password .....	27
Key as Send .....	27
Phone Lock .....	28
Audio Settings.....	31
Volume.....	31
Ring Tones .....	32
Contact Management.....	34
Directory.....	35
Local Directory .....	36
Blacklist.....	49
Remote Phone Book.....	51
Call History Management.....	53
System Customizations.....	55
Headset Use .....	55
Bluetooth Headset.....	57
DSS Keys .....	62
Account Management .....	75
Dial Plan .....	77
Emergency Number.....	83
Live Dialpad.....	84
Hotline.....	85
<b>Basic Call Features.....</b>	<b>87</b>
Placing Calls.....	87
Answering Calls .....	90
Ending Calls .....	91
Redialing Numbers .....	92
Recent Call In Dialing .....	92
Auto Answer.....	93
Auto Redial.....	94
Call Completion .....	95
Recall .....	97
Call Mute.....	97
Call Hold/Resume .....	98
Do Not Disturb (DND) .....	99
Call Forward.....	103
Call Transfer .....	110
Call Waiting.....	112
Conference.....	113
Local Conference.....	113
Network Conference .....	114
Call Park .....	116

---

Call Pickup.....	117
Anonymous Call.....	121
Anonymous Call Rejection.....	122
<b>Advanced Phone Features.....</b>	<b>125</b>
Busy Lamp Field (BLF).....	125
BLF List .....	127
Call Recording.....	129
Hot Desking.....	131
Intercom .....	133
Outgoing Intercom Calls .....	133
Incoming Intercom Calls.....	134
Multicast Paging .....	136
Sending RTP Stream .....	136
Receiving RTP Stream.....	140
Music on Hold .....	141
Automatic Call Distribution (ACD) .....	142
Messages.....	144
Short Message Service (SMS).....	144
Voice Mail.....	147
Message Waiting Indicator (MWI) .....	149
<b>Troubleshooting .....</b>	<b>153</b>
<b>Regulatory Notices .....</b>	<b>163</b>
Service Agreements .....	163
Limitations of Liability .....	163
Safety Instructions.....	163
<b>Appendix A - Time Zones.....</b>	<b>165</b>
<b>Index.....</b>	<b>169</b>





## Overview

This chapter provides the overview of the SIP-T46G IP phone. Topics include:

- [Hardware Component Instructions](#)
- [Icon Instructions](#)
- [LED Instructions](#)
- [User Interfaces](#)
- [Documentations](#)





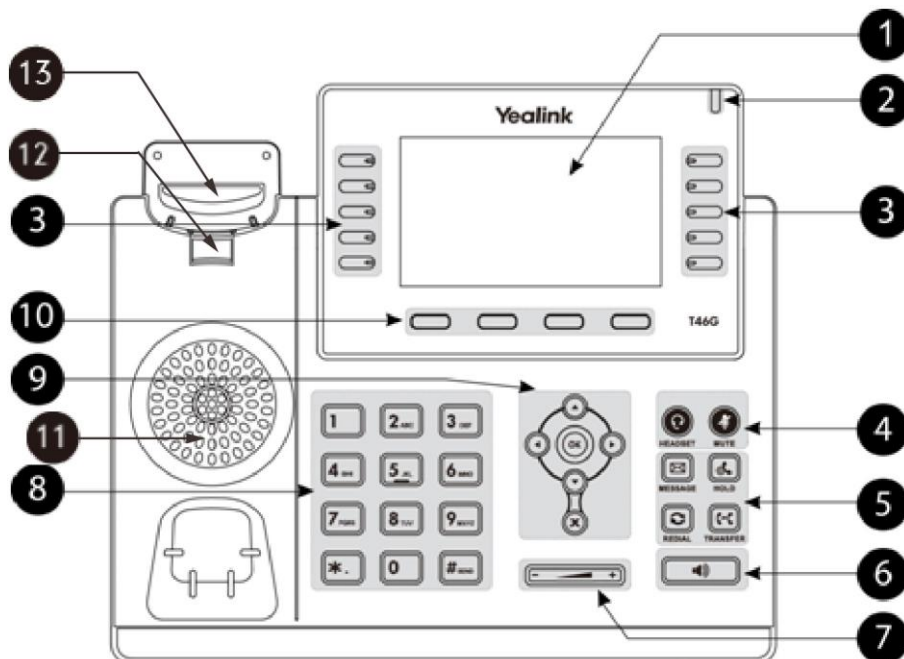

If you require additional information or assistance with your new phone, contact your system administrator.

## Hardware Component Instructions

The main hardware components of the SIP-T46G IP phone are the LCD screen and the keypad.





























Hardware component instructions of the SIP-T46G IP phone are:

	Item	Description
①	LCD Screen	Shows information about calls, messages, soft keys, time, date and other relevant data: <ul style="list-style-type: none"> <li>• Call information—caller ID, call duration</li> <li>• Icons (for example,  )</li> <li>• Missed call text or second incoming caller information</li> <li>• Prompt text (for example, "Saving config file!")</li> <li>• Time and date</li> </ul>
②	Power Indicator LED	Indicates phone power and some feature statuses.
③	Line Keys	Use these keys to activate up to sixteen accounts and assign various features.
④	HEADSET Key	Toggles and indicates the headset mode.
	MUTE Key	Toggles and indicates mute feature.
⑤	MESSAGE Key	Accesses voice messages.
	HOLD Key	Places a call on hold or resumes a held call.
	REDIAL Key	Redials a previously dialed number.
	TRANSFER Key	Transfers a call to another party.
⑥	Speakerphone Key	Toggles the hands-free speakerphone mode.
⑦	Volume Key	Adjusts the volume of the handset, headset, speaker, and ringer.
⑧	Keypad	Provides the digits, letters and special characters in context-sensitive applications.
⑨	   	Scroll through the displayed information.
		Confirms actions or answers incoming calls.
		Cancels actions or rejects incoming calls.
⑩	Soft Keys	Label automatically to identify their context-sensitive features.
⑪	Speaker	Provides ringer and hands-free (speakerphone) audio output.
⑫	Hookswitch Tab	Secures the handset in the handset cradle when the IP phone is mounted vertically. For more information on how to adjust the hookswitch tab, refer to <i>Yealink Wall Mount Quick Installation Guide for T4X IP Phones</i> .
⑬	Hookswitch	Picking up the handset from the handset cradle, the hookswitch bounces and the phone connects to the line, laying the handset down on the handset cradle, the phone disconnects from the line.

## Icon Instructions

Icons appearing on the LCD screen are described in the following table:

Icons	Description
	Network is unavailable
	Registered successfully
	Register failed
	Registering
	Hands-free speakerphone mode
	Handset mode
	Headset mode
	Multi-lingual lowercase letters input mode
	Multi-lingual uppercase letters input mode
	Alphanumeric input mode
	Numeric input mode
	Multi-lingual uppercase and lowercase letters input mode
	Voice Mail
	Text Message
	Auto Answer
	Do Not Disturb
	Call Forward
	Call Hold
	Call Mute

Icons	Description
	Ringer volume is 0
	Phone Lock
	Received Calls
	Placed Calls
	Missed Calls
	Recording box is full
	A call cannot be recorded
	Recording starts successfully
	Recording cannot be started
	Recording cannot be stopped
	Bluetooth
	Bluetooth headset is both paired and connected
	Conference
	The contact icon
	The default caller photo

## LED Instructions

### Power Indicator LED

LED Status	Description
Solid red	The phone is initializing.
Fast flashing red (300ms)	The phone is ringing.
Slow flashing red (1s)	The phone receives a text message or voice mail.
Off	The phone is powered off. The phone is idle.

LED Status	Description
	The phone is busy. The call is placed on hold or is held. The call is muted.

#### Line key LED

LED Status	Description
Solid green	The line is seized. The line is in conversation.
Fast flashing green	The line receives an incoming call.
Slow flashing green	The call is placed on hold.
Off	The line is inactive.

#### Line key LED (configured as a BLF key or BLF List key)

LED Status	Description
Solid green	The monitored user is idle.
Fast flashing red (200ms)	The monitored user receives an incoming call.
Solid red	The monitored user is busy.
Slow flashing red (1s)	The call is parked against the monitored user's phone number. The monitored user's conversation is placed on hold (This status requires server support).
Off	The monitored user does not exist.

#### Line key LED (used as a page switch key)

LED Status	Description
Solid red	There is a parked call on the line key of the non-current page.
Fast flashing green	The line receives an incoming call on the line key of the non-current page.
Fast flashing red	The monitored user receives an incoming call on the line key of the non-current page.
Off	The line keys are idle.

#### Note

The above introduces the default LED status. The statuses of the power indicator LED and BLF key are configurable via web user interface. For more information, refer to *Yealink\_SIP-T4X\_IP\_Phones\_Administrator\_Guide*.

## User Interfaces

Two ways to customize configurations of your SIP-T46G IP phone:

- The user interface on the IP phone.
- The user interface in a web browser on your PC.

The hardware components keypad and LCD screen constitute the phone user interface, which allows the user to execute all call operation tasks and basic configuration changes directly on the phone. In addition, you can use the web user interface to access all configuration settings. In many cases, it is possible to use either the phone user interface and/or the web user interface interchangeably. However, in some cases, it is only possible to use one or the other interface to operate the phone and change settings.

### Phone User Interface

You can customize your phone by pressing the Menu soft key to access the phone user interface. The Advanced option is only accessible to the administrator, and the default administrator password is “admin” (case-sensitive). For more information on customizing your phone with the available options from the phone user interface, refer to [Customizing Your Phone](#) on page 21.

### Web User Interface

In addition to the phone user interface, you can also customize your phone via web user interface. In order to access the web user interface, you need to know the IP address of your new phone. To obtain the IP address, press the OK key on the phone when the phone is idle. Enter the IP address (e.g., http://192.168.0.10 or 192.168.0.10) in the address bar of a web browser on your PC. The default administrator user name and password are both “admin” (case-sensitive).

The options you can use to customize the IP phone via phone user interface and/or via web user interface are listed in the following table:

Options	Phone User Interface	Web User Interface
<b>Status</b>	√	√
--IP Address		
--MAC		
--Firmware		
--Network		
--Phone		
--Accounts		
<b>Basic Phone Settings</b>		√

Options	Phone User Interface	Web User Interface
--Wallpaper	√	
--Backlight	√	
--Contrast	√	
--Language	√	
--Time & Date	√	
--Administrator Password	√	
--Key as Send	√	
--Phone Lock	√	
--Ring Tones	√	
--Contact Management	x	
--Directory	x	
--Local Directory	√	
--Blacklist	√	
--Remote Phone Book	x	
--Call History Management	√	
--DSS Keys	√	
--Account Registration	√	
--Dial Plan	x	
--Emergency Number	x	
--Live Dialpad	x	
--Hotline	√	
<b>Basic Call Features</b>		
--Recent Call In Dialing	x	
--Auto Answer	√	
--Auto Redial	√	
--Call Completion	√	
--Recall	√	
--Do Not Disturb (DND)	√	
--Call Forward	√	√
--Call Transfer	√	
--Call Waiting	√	
--Conference	x	
--Call Park	√	
--Call Pickup	√	
--Anonymous Call	√	
--Anonymous Call Rejection	√	
<b>Advanced Phone Features</b>		
--Busy Lamp Field (BLF)	√	
--BLF List	x	√
--Call Recording	√	
--Hot Desking	√	

Options	Phone User Interface	Web User Interface
--Intercom	√	
--Multicast Paging	×	
--Music on Hold	×	
--ACD	×	
--Messages	√	
<b>SIP Account</b>		
--User Options	×	
--Activation	√	
--Label	√	
--Display Name	√	
--Register Name	√	
--User Name	√	√
--Password	√	
--SIP Server1/2	√	
--Server Option	×	
--Registrar Port	×	
--Outbound Status	√	
--Outbound Proxy	√	
--NAT Status	√	

**Note**

The table above lists most of the feature options. Please refer to the relevant sections for more information.

## Documentations

The following table shows documentations available for the SIP-T46G IP phone.

Name	Contents	Where found	Language
Quick Start Guide	Basic call features and phone customizations	In the package	English
User Guide	Phone/Web user interface settings Basic call features and advanced phone features	On the website	English

**Note**

You can also download the latest documentations online:  
[http://www.yealink.com/SupportDownloadfiles\\_detail.aspx?CatelId=310&flag=142](http://www.yealink.com/SupportDownloadfiles_detail.aspx?CatelId=310&flag=142).



# Getting Started

This chapter provides the following basic installation instructions and information for obtaining the best performance with the SIP-T46G IP phone. Topics include:

- [Packaging Contents](#)
- [Phone Installation](#)
- [Phone Initialization](#)
- [Phone Status](#)
- [Basic Network Settings](#)
- [Registration](#)
- [Idle Screen](#)

If you require additional information or assistance with your new phone, contact your system administrator.

## Packaging Contents

The following components are included in your SIP-T46G IP phone package:

- **SIP-T46G IP Phone**

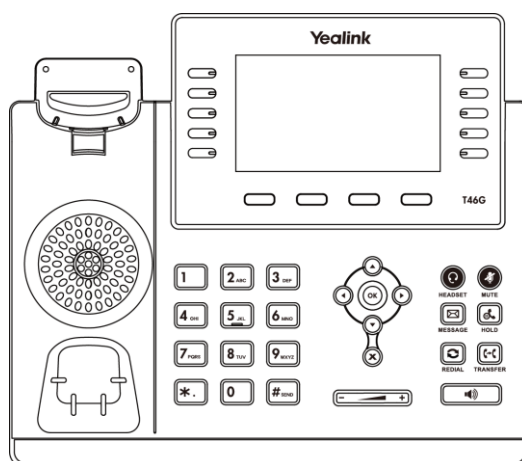

- **Phone Stand**

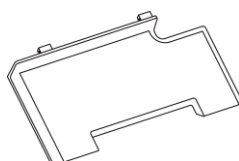

- **Handset & Handset Cord**

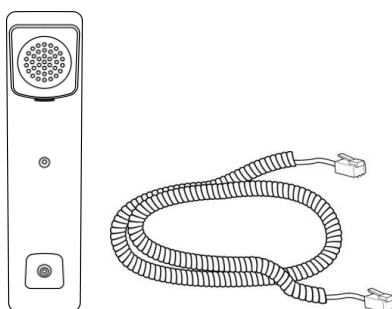

- **Ethernet Cable**

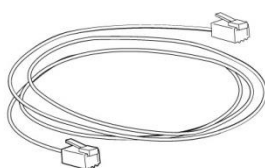

- **Quick Start Guide**

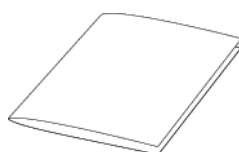

Check the list before installation. If you find anything missing, contact your system administrator.

## Optional Accessories

The following items are optional accessories for your SIP-T46G IP phone. You need to purchase them separately if required.

- **Wall Mount Bracket**

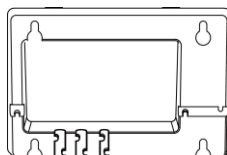

- Power Adapter

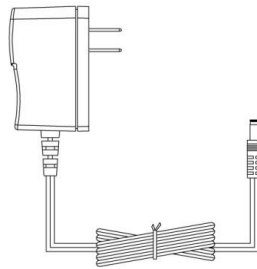

- Headset



- Wireless Headset Adapter EHS36



## Phone Installation

If your phone is already installed, proceed to [Phone Initialization](#) on page 14.

This section introduces how to install the phone:

- 1) Attach the stand or the optional wall mount bracket
- 2) Connect the handset and optional headset
- 3) Connect the network and power

1) Attach the stand or the optional wall mount bracket

Desk Mount Method

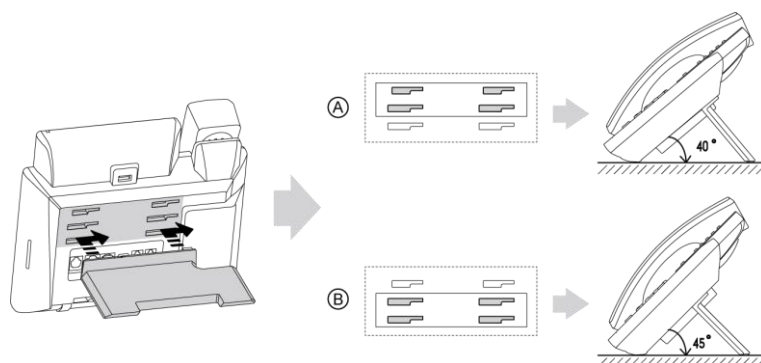

Wall Mount Method (Optional)

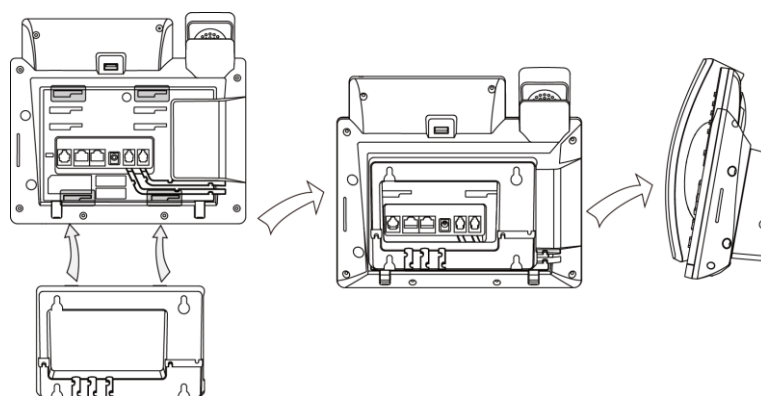

**Note**

The wall mount bracket should be purchased separately. For more information on how to attach the wall mount bracket, refer to *Yealink Wall Mount Quick Installation Guide for T4X IP Phones*.

## 2) Connect the handset and optional headset

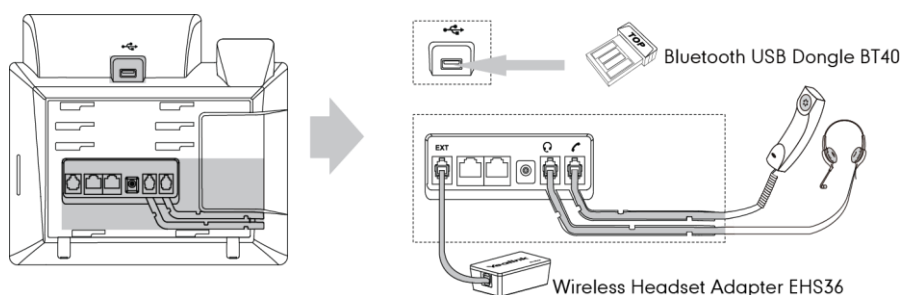

### Note

The headset, wireless headset adapter EHS36 and Bluetooth USB dongle BT40 should be purchased separately.

The EXT port can also be used to connect an expansion module EXP40.

For more information on how to use EHS36, EXP40 and Bluetooth USB Dongle BT40, refer to Yealink EHS36 User Guide, Yealink EXP40 User Guide and Yealink Bluetooth USB Dongle BT40 User Guide.

## 3) Connect the network and power

You have two options for power and network connections. Your system administrator will advise you which one to use.

- AC power (Optional)
- Power over Ethernet (PoE)

### AC Power (Optional)

To connect the AC power:

1. Connect the DC plug on the power adapter to the DC5V port on the phone and connect the other end of the power adapter into an electrical power outlet.
2. Connect the included or a standard Ethernet cable between the Internet port on the phone and the one on the wall or switch/hub device port.

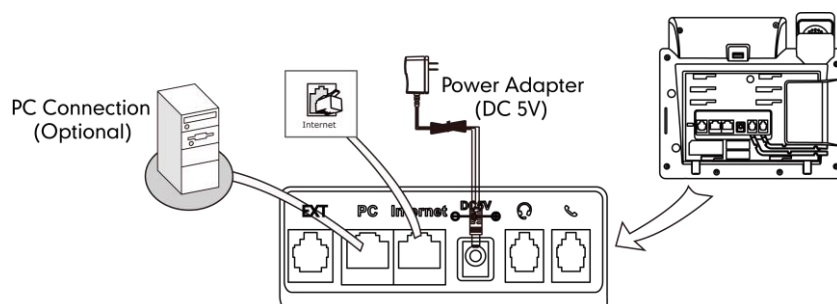

## Power over Ethernet

With the included or a regular Ethernet cable, the SIP-T46G IP phone can be powered from a PoE-compliant switch or hub.

### To connect the PoE:

1. Connect the Ethernet cable between the Internet port on the phone and an available port on the in-line power switch/hub.

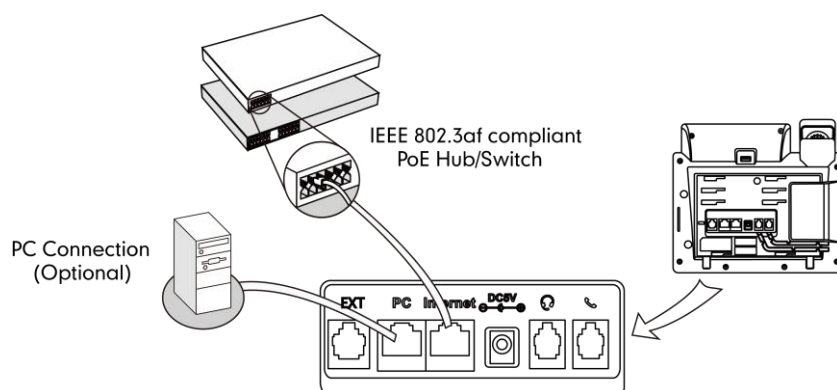

### Note

If in-line power is provided, you don't need to connect the phone to the power adapter. Make sure the switch/hub is PoE-compliant.

The phone can also share the network with another network device such as a PC (personal computer). This is an optional connection.

**Important!** Do not remove power to the phone while it is updating firmware and configurations.

## Phone Initialization

After your phone is powered on, the system boots up and performs the following steps:

### Automatic Phone Initialization

The phone finishes the initialization by loading the saved configuration. The LCD screen displays "Initializing...Please wait" during the initialization.

### DHCP (Dynamic Host Configuration Protocol)

The phone attempts to contact a DHCP server in your network to obtain valid IPv4 network settings (e.g., IP address, subnet mask, default gateway address and DNS address) by default.

### Note

If your network does not use DHCP, proceed to [Basic Network Settings](#) on page 16.

## Phone Status

You can view phone status via phone user interface or web user interface.



Available information of phone status includes:

- Network status (e.g., IPv4 status, IPv6 status, IP address mode and MAC address).
- Phone status (e.g., device model, hardware version, firmware version, product ID, MAC address and device certificate status).
- Account status (e.g., register status of SIP accounts).

### Note

You can view device certificate status via phone user interface only.

**To view the phone status via phone user interface:**

1. Press , or press **Menu->Status**.
2. Press  or  to scroll through the list and view the specific information.



**To view the phone status via web user interface:**

1. Open a web browser on your computer.
2. Enter the IP address in the browser's address bar, and then press the **Enter** key.
3. Enter the user name (admin) and password (admin) in the login page.



4. Click **Confirm** to login.

The phone status is displayed on the first page of the web user interface.

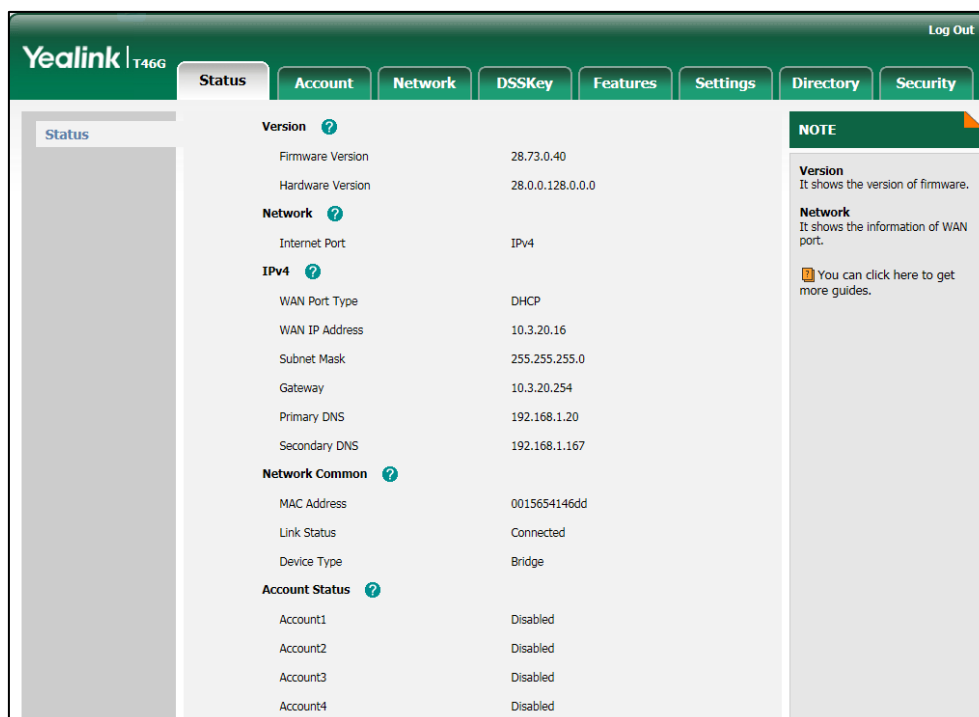

The screenshot shows the Yealink T46G web user interface. The top navigation bar includes 'Status', 'Account', 'Network', 'DSSKey', 'Features', 'Settings', 'Directory', and 'Security'. The 'Status' page is active, displaying the following information:

Version	
Firmware Version	28.73.0.40
Hardware Version	28.0.0.128.0.0.0
Network	
Internet Port	IPv4
IPv4	
WAN Port Type	DHCP
WAN IP Address	10.3.20.16
Subnet Mask	255.255.255.0
Gateway	10.3.20.254
Primary DNS	192.168.1.20
Secondary DNS	192.168.1.167
Network Common	
MAC Address	0015654146dd
Link Status	Connected
Device Type	Bridge
Account Status	
Account1	Disabled
Account2	Disabled
Account3	Disabled
Account4	Disabled

A 'NOTE' box on the right side of the page states: 'Version: It shows the version of firmware. Network: It shows the information of WAN port. You can click here to get more guides.'

## Basic Network Settings

If your phone cannot contact a DHCP server for any reason, you need to configure network settings manually. The IP phone can support either or both IPv4 and IPv6 addresses.

To configure the IP address mode via phone user interface:

1. Press **Menu**->**Advanced** (default password: admin) ->**Network**->**WAN Port**.
2. Press **←** or **→**, or the **Switch** soft key to select **IPv4**, **IPv6** or **IPv4 & IPv6** from the **IP Address Mode** field.

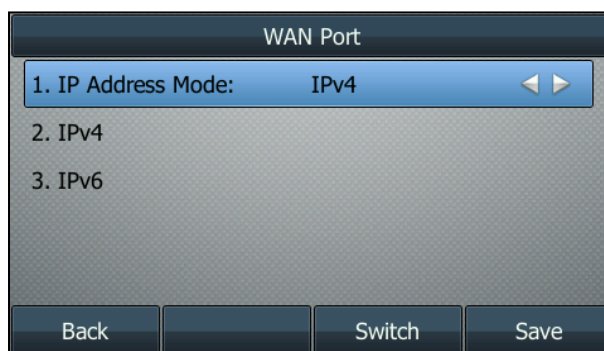

3. Press the **Save** soft key to accept the change or the **Back** soft key to cancel.



#### To configure a static IPv4 address via phone user interface:

1. Press **Menu->Advanced** (default password: admin) ->**Network->WAN Port->IPv4**.
2. Press ◀ or ▶ , or the **Switch** soft key to select the **Static IP** from the **Type** field.
3. Enter the desired values in the **IP Address**, **Subnet Mask**, **Gateway**, **Primary DNS** and **Secondary DNS** fields respectively.

IPv4 WAN Port	
1. Type:	Static IP ◀ ▶
2. IP Address:	192.168.1.10
3. Subnet Mask:	255.255.255.0
4. Gateway:	192.168.1.1
5. Primary DNS:	202.101.103.55
<input type="button" value="Back"/> <input type="button" value="123"/> <input type="button" value="Delete"/> <input type="button" value="Save"/>	

4. Press the **Save** soft key to accept the change or the **Back** soft key to cancel.

#### To configure a static IPv6 address via phone user interface:

1. Press **Menu->Advanced** (default password: admin) ->**Network->WAN Port->IPv6**.
2. Press ◀ or ▶ , or the **Switch** soft key to select the **Static IP** from the **Type** field.
3. Enter the desired values in the **IP Address**, **IPv6 IP Prefix**, **Gateway**, **Primary DNS** and **Secondary DNS** fields respectively.

IPv6 WAN Port	
1. Type:	Static IP ◀ ▶
2. IP Address:	2005:1:1:1:1::25
3. IPv6 IP Prefix:	64
4. Gateway:	2055:1:1:1:1
5. Primary DNS:	2005:1:1:1:1::89
<input type="button" value="Back"/> <input type="button" value="123"/> <input type="button" value="Delete"/> <input type="button" value="Save"/>	

4. Press the **Save** soft key to accept the change or the **Back** soft key to cancel.

If you are using an xDSL modem for IPv4 network connection, you can connect your phone to the Internet via PPPoE mode. Set the WAN port as a PPPoE port. The PPPoE port will perform a PPP negotiation to obtain the IP address. Contact your system administrator for the PPPoE user name and password.

#### To configure PPPoE via phone user interface:

1. Press **Menu->Advanced** (default password: admin) ->**Network->WAN Port->IPv4**.
2. Press ◀ or ▶ , or the **Switch** soft key to select the **PPPoE** from the **Type** field.

3. Enter the user name and password in the corresponding fields.

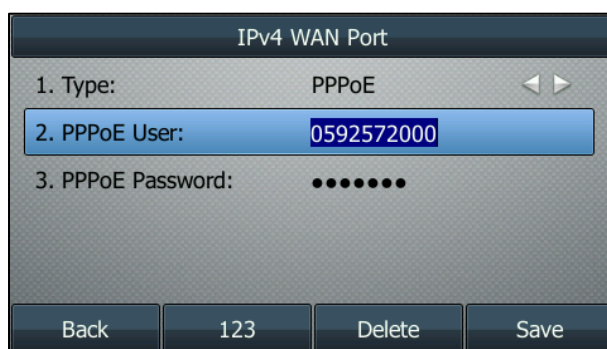

4. Press the **Save** soft key to accept the change or the **Back** soft key to cancel.

**Note** Wrong network settings may result in inaccessibility of your phone and may also have an impact on your network performance. For more information on these parameters, contact your system administrator.

## Registration

Generally, your phone will be deployed with multiple other phones. In this case, your system administrator will configure the phone parameters beforehand, so that after you start up your phone, the phone will be registered and ready for use. The SIP-T46G IP phone supports up to 16 accounts. If your phone is not registered, you may have to register it. For more information on how to register your phone, refer to [Account Management](#) on page 75.

## Idle Screen

If the phone has successfully started up, the idle LCD screen will be displayed as below.

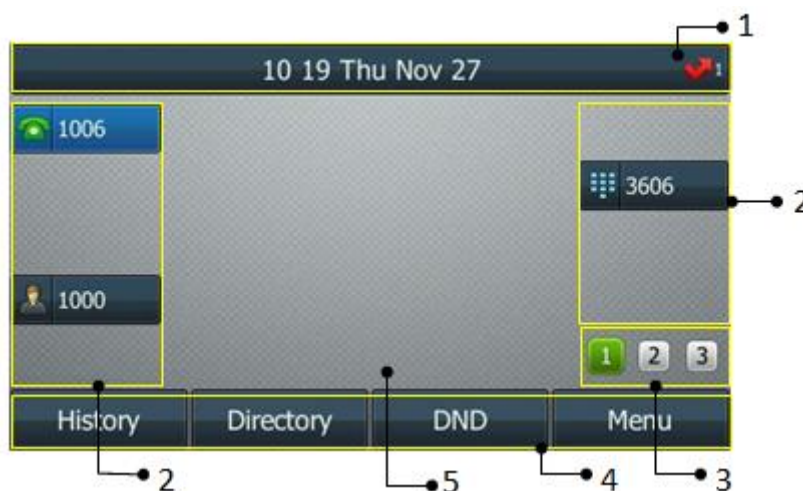

**Idle Screen description:**

No.	Description
1	This area shows the phone's time, date and feature status. For more information, refer to <a href="#">Icon Instructions</a> on page 3.
2	This area shows the line key labels. You can customize the line key as other functions. For more information, refer to <a href="#">Line Keys</a> on page 62.
3	This area shows three page icons.
4	This area shows the soft key labels. The default soft key labels are "History", "Directory", "DND" and "Menu".
5	This area shows the wallpaper which can be customized. For more information, refer to <a href="#">Wallpaper</a> on page 21.



# Customizing Your Phone

You can customize your SIP-T46G IP phone by personally configuring certain settings, for example, contrast, time & date and ring tones. You can add contacts to the phone's local directory manually or from call history. You can also personalize different ring tones for different callers.

This chapter provides basic operating instructions for customizing your phone. Topics include:

- [General Settings](#)
- [Audio Settings](#)
- [Contact Management](#)
- [Call History Management](#)
- [System Customizations](#)

If you require additional information or assistance with your new phone, contact your system administrator.

## General Settings



### Wallpaper

You can customize the wallpaper of the SIP-T46G IP phone, and can change the wallpaper image via phone user interface or web user interface. You can also upload custom wallpaper images via web user interface. The file format of wallpaper image must be \*.jpg, \*.png or \*.bmp. Contact your system administrator for the detailed requirement of the file format.

**To change the wallpaper via phone user interface:**

1. Press **Menu->Basic->Display->Wallpaper**.



2. Press  or  , or the **Switch** soft key to select the desired wallpaper image.
3. Press the **Save** soft key to accept the change or the **Back** soft key to cancel.

Wallpaper is configurable via web user interface at the path **Settings->Preference**.

**To upload the customized wallpaper via web user interface:**

1. Click on **Settings->Preference**.
2. In the **Upload Wallpaper(480\*272)** field, click **Browse** to select the wallpaper image from your local system.

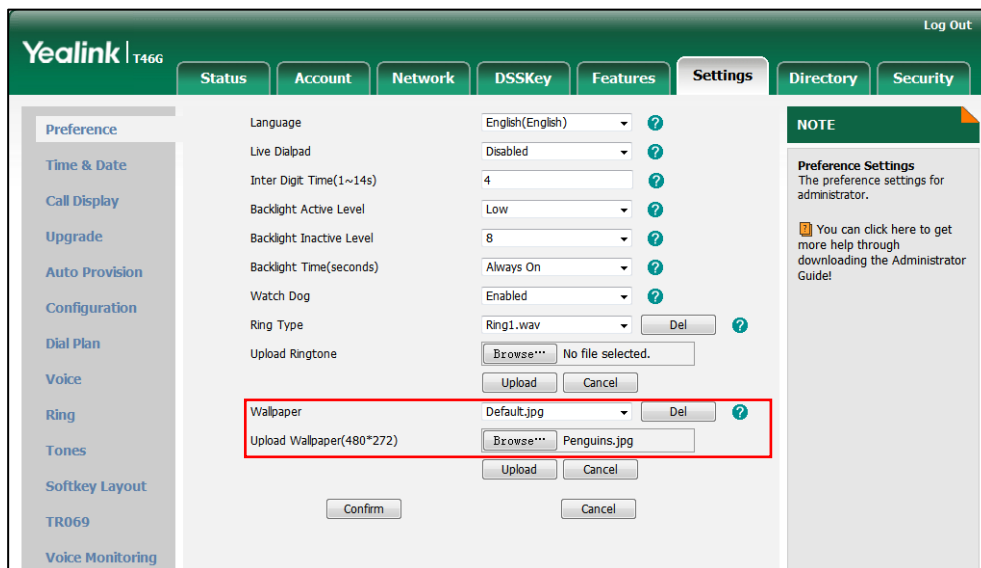

3. Click **Upload** to upload the file.
4. Click **Confirm** to accept the change.

The customized wallpaper Level appears in the pull-down list of **Wallpaper**.

**Note** The SIP-T46G IP phone screen size is 480\*272 pixels. If the size of the custom wallpaper doesn't meet the IP phone screen size, the wallpaper will be stretched or/and zoomed out according to the IP phone screen size.

## Backlight

Backlight has three options:

**Backlight Active Level:** The intensity of the LCD screen when the phone is active. You can change the intensity of the LCD screen. Digits (1-10) represent different intensities. 10 is the highest intensity.

**Backlight Inactive Level:** The intensity of the LCD screen when the phone is inactive. You can select a low intensity or turn off the backlight.

**Backlight Time:** The delay time to change the intensity of the LCD screen when the phone is inactive. You can select a desired time to change the intensity or turn on the

backlight permanently.

To configure the backlight via phone user interface:

1. Press **Menu->Basic->Display->Backlight**.



2. Press  $\leftarrow$  or  $\rightarrow$ , or the **Switch** soft key to select the desired level from the **Backlight Active Level** field.
3. Press  $\leftarrow$  or  $\rightarrow$ , or the **Switch** soft key to select the desired value from the **Backlight Inactive Level** field.
4. Press  $\leftarrow$  or  $\rightarrow$ , or the **Switch** soft key to select the desired time from the **Backlight Time** field.
5. Press the **Save** soft key to accept the change or the **Back** soft key to cancel.

Backlight is configurable via web user interface at the path **Settings->Preference**.

## Contrast

You can configure the contrast of EXP40 to a comfortable level. Ensure EXP40 has been connected to the phone before configuration.

To configure the contrast via phone user interface:

1. Press **Menu->Basic->Display->Contrast**.



2. Press  $\leftarrow$  or  $\rightarrow$ , or the **Switch** soft key to increase or decrease the intensity of contrast.



The default contrast level is 6.

3. Press the **Save** soft key to accept the change or the **Back** soft key to cancel.

## Language

The default language of the phone user interface is English. If the language of your web browser is not supported by the phone, the web user interface will use English by default. You can change the language for the phone user interface and the web user interface respectively.

### To change the language for the phone user interface:

1. Press **Menu->Basic->Language**.
2. Press  or  to select the desired language.



3. Press the **Save** soft key to accept the change.

Text displayed on the phone user interface will change to the selected language.

### To change the language for the web user interface:

1. Click on **Settings->Preference**.
2. Select the desired language from the pull-down list of **Language**.

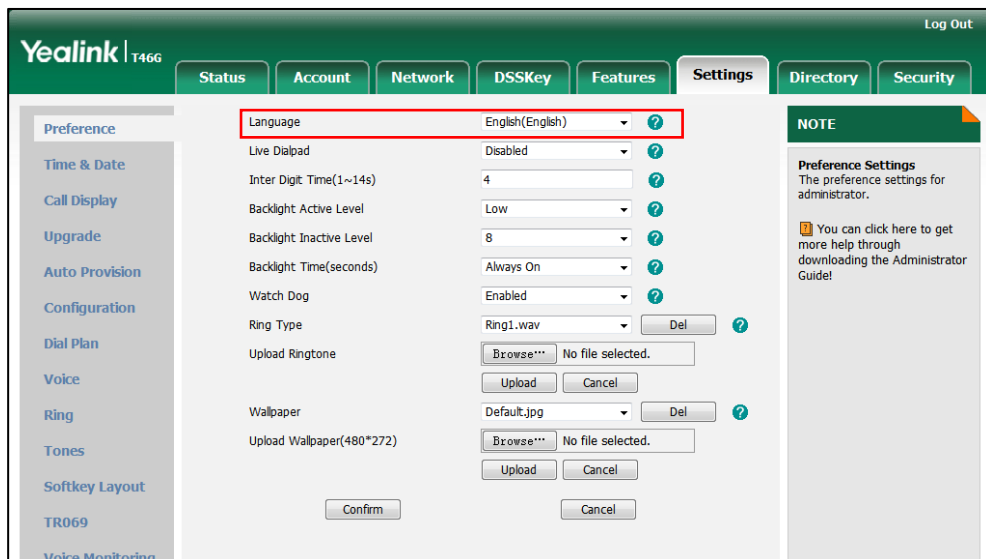



3. Click **Confirm** to accept the change.

Text displayed on the web user interface will change to the selected language.

## Time & Date

The time and date are displayed on the LCD screen when the phone is idle. You can configure the phone to obtain the time and date from the SNTP server automatically, or configure the time and date manually. If the phone cannot obtain the time and date from the Simple Network Time Protocol (SNTP) server, contact your system administrator for more information.

**To configure the SNTP settings via phone user interface:**

1. Press **Menu->Basic->Time & Date->General->SNTP Setting**.
2. Press **◀** or **▶**, or the **Switch** soft key to select the time zone that applies to your area from the **Time Zone** field.  
The default time zone is "+8 China(Beijing)".
3. Enter the domain names or IP addresses in the **NTP Server 1** and **NTP Server 2** fields respectively.
4. Press **◀** or **▶**, or the **Switch** soft key to select the desired value from the **Daylight Saving** field.



5. Press the **Save** soft key to accept the change or the **Back** soft key to cancel.

### Note

Please refer to [Appendix A - Time Zones](#) for the list of available time zones on the IP phone.

**To configure the time and date manually via phone user interface:**

1. Press **Menu->Basic->Time & Date->General->Manual Setting**.

2. Enter the specific date and time.

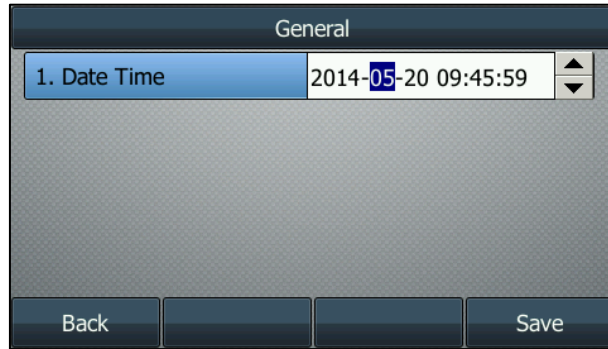

3. Press the **Save** soft key to accept the change.

The time and date displayed on the LCD screen will change accordingly.

**To configure the date and time format via phone user interface:**

1. Press **Menu->Basic->Time & Date->Time & Date Format**.
2. Press or , or the **Switch** soft key to select the desired date format from the **Date Format** field.



3. Press or , or the **Switch** soft key to select the desired time format (12 Hour or 24 Hour) from the **Time Format** field.
4. Press the **Save** soft key to accept the change or the **Back** soft key to cancel.

There are 7 available date formats. For example, for the date format “WWW DD MMM”, “WWW” represents the abbreviation of the weekday, “DD” represents the two-digit day, and “MMM” represents the first three letters of the month.

The date formats available:

Date Format	Example (2014-7-26)
WWW MMM DD	Sat Jul 26
DD-MMM-YY	26-Jul-14
YYYY-MM-DD	2014-07-26
DD/MM/YYYY	26/07/2014

Date Format	Example (2014-7-26)
MM/DD/YY	07/26/14
DD MMM YYYY	26 Jul 2014
WWW DD MMM	Sat 26 Jul

Time and date are configurable via web user interface at the path **Settings->Time & Date**.

## Administrator Password

The Advanced option is only accessible to the administrator. The default administrator password is "admin". For security reasons, you should change the default administrator password as soon as possible.

**To change the administrator password via phone user interface:**

1. Press **Menu->Advanced** (default password: admin) ->**Set Password**.
2. Enter the old password in the **Current PWD** field.
3. Enter the new password in the **New PWD** field.
4. Re-enter the new password in the **Confirm PWD** field.

5. Press the **Save** soft key to accept the change or the **Back** soft key to cancel.



Administrator password is configurable via web user interface at the path **Security->Password**.

## Key as Send

You can set the "#" or "\*" to perform as a send key while dialing.

**To configure key as send via phone user interface:**

1. Press **Menu->Features->Others->General**.

- Press  or  , or the **Switch** soft key to select **#** or **\*** from the **Key as Send** field, or select **Disabled** to disable this feature.



- Press the **Save** soft key to accept the change or the **Back** soft key to cancel.

Key as send is configurable via web user interface at the path **Features->General Information**.

## Phone Lock

You can lock your phone temporarily when you are not using it. This feature helps to protect your phone from unauthorized use.



Phone lock consists of the following:

- Menu Key:** The Menu soft key is locked. You cannot access the menu of the phone until unlocked.
- Function Keys:** The function keys are locked. You cannot use the MESSAGE, REDIAL, HOLD, MUTE, TRANSFER, OK, X, navigation keys, soft keys and line keys until unlocked.
- All Keys:** All keys are locked except the Volume key. You are only allowed to dial emergency numbers, reject incoming calls by pressing the X key, answer incoming calls by lifting the handset, pressing the Speakerphone key, the HEADSET key or the OK key, mute an active call by pressing the X key, place an active call on hold by pressing the Hold soft key, resume the held call by pressing the Resume soft key, and end the call by hanging up the handset or pressing the Speakerphone key.



### Note

The emergency number setting, if desired, must be made before lock activation. For more information, refer to [Emergency Number](#) on page 83.

**To activate the phone lock via phone user interface:**

- Press **Menu->Advanced** (default password: admin) ->**Phone Settings->Phone Lock**.
- Press  or  , or the **Switch** soft key to select **Enabled** from the **Lock Enable**

field.

3. Press  or  , or the **Switch** soft key to select the desired type from the **Lock Type** field.



4. Press the **Save** soft key to accept the change.

Long press  to lock the phone immediately when the phone is idle.

The LCD screen prompts "Phone locked." and displays the icon .

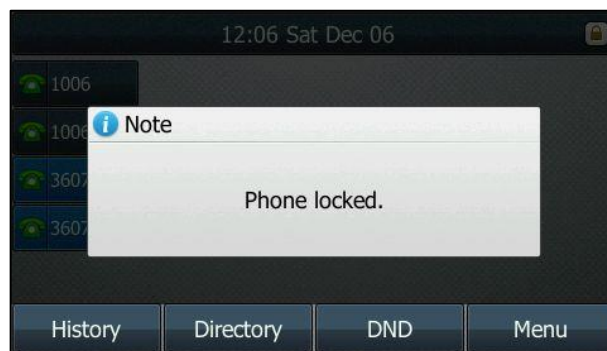

You can configure the interval (in seconds) to automatically lock the phone instead of long pressing .

**To configure the interval of automatic phone lock via web user interface:**

1. Click on **Features->Phone Lock**.
2. Enter the desired time in the **Phone Lock Time Out (0~3600s)** field.

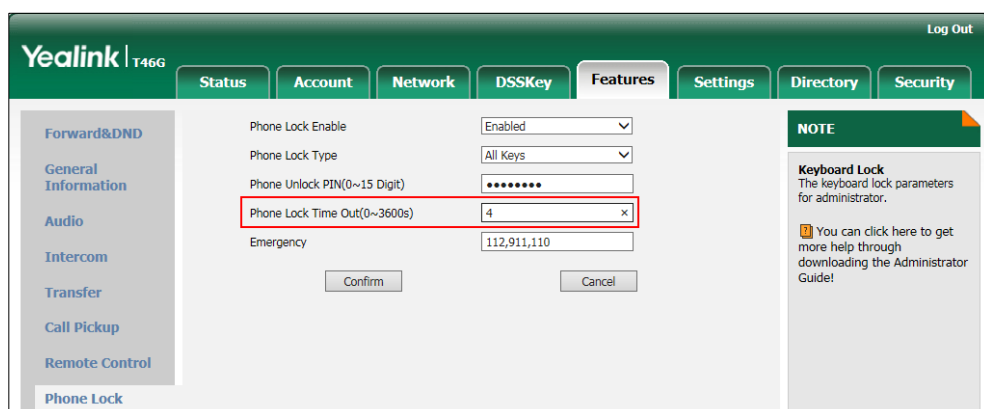

3. Click **Confirm** to accept the change.

**Note** The default timeout is 0 second, that is, you need to long press  to lock the phone only.  
Interval of automatic phone lock is configurable via web user interface only.

To unlock the phone, you must know the phone unlock PIN of the phone. The default phone unlock PIN is "123".

**To change the phone unlock PIN via phone user interface:**

1. Press **Menu->Basic->Change PIN**.
2. Enter the desired values in the **Current PIN**, **New PIN** and **Confirm PIN** fields respectively.





3. Press the **Save** soft key to accept the setting or the **Back** soft key to cancel.

**Note** The unlock PIN length must be within 15 digits.

**To unlock the phone via phone user interface:**

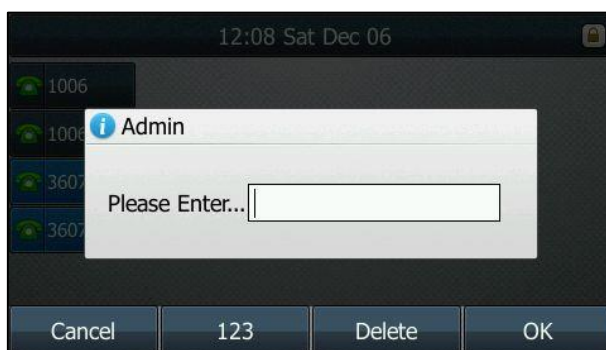
1. Press any locked key, the LCD screen prompts "Please Enter...".





2. Enter the PIN in the **Please Enter...** field.
3. Press the **OK** soft key to unlock the phone.  
The  icon disappears from the LCD screen.

You can long press  or wait for a period of time (if configured) to lock the phone again.

### Note

You can also unlock the phone by administrator password.

To deactivate the phone lock via phone user interface:

1. Press **Menu->Advanced** (default password: admin) ->**Phone Settings->Phone Lock**.
2. Press  or  , or the **Switch** soft key to select **Disabled** from the **Lock Enable** field.



3. Press the **Save** soft key to accept the change.

Phone lock is configurable via web user interface at the path **Features->Phone Lock**.

## Audio Settings

### Volume

You can press the volume key to adjust the ringer volume when the phone is idle. You can also press the volume key to adjust the receiver volume of currently engaged audio devices (handset, speakerphone or headset) when the phone is in use.



**To adjust the volume when the phone is idle:**

1. Press  to adjust the ringer volume.



**Note**

If ringer volume is adjusted to minimum, the  icon will appear on the LCD screen.

**To adjust the volume when the phone is during a call:**

1. Press  to adjust the volume of currently engaged audio device (handset, speakerphone or headset).





## Ring Tones

Ring tones are used to indicate incoming calls. You can select different ring tones to distinguish different accounts registered on your phone, or to distinguish your phone from your neighbor's.

**To select a ring tone for the phone via phone user interface:**

1. Press **Menu->Basic->Sound->Ring Tones->Common**.



2. Press  or  to select the desired ring tone.





3. Press the **Save** soft key to accept the change or the **Back** soft key to cancel.

A ring tone for the phone is configurable via web user interface at the path **Settings->Preference->Ring Type**.

**To select a ring tone for the account via phone user interface:**

1. Press **Menu->Basic->Sound->Ring Tones**.
2. Press  or  to select the desired account and then press the **Enter** soft key.



3. Press  or  to select the desired ring tone.  
If **Common** is selected, this account will use the ring tone selected for the phone.



4. Press the **Save** soft key to accept the change or the **Back** soft key to cancel.

A ring tone for the account is configurable via web user interface at the path **Account->Basic->Ring Type**.

**Note**

The ring tone for an incoming call on the phone may be different. For example, when the phone receives an incoming call from a contact stored in the local directory, it will play the ring tone assigned to the contact in the local directory (refer to [Adding Contacts](#)). If no ring tone is assigned to the contact, the phone will play the ring tone assigned to the associated group (refer to [Groups](#)). Otherwise, the phone will play the ring tone assigned to the account. If no ring tone is assigned to the contact, the associated group or account, the phone will play the ring tone assigned to the phone.

To upload a custom ring tone for your phone via web user interface:

1. Click on **Settings->Preference**.
2. In the **Upload Ringtone** field, click **Browse** to locate a ring tone (the file format must be \*.wav) file from your local system.

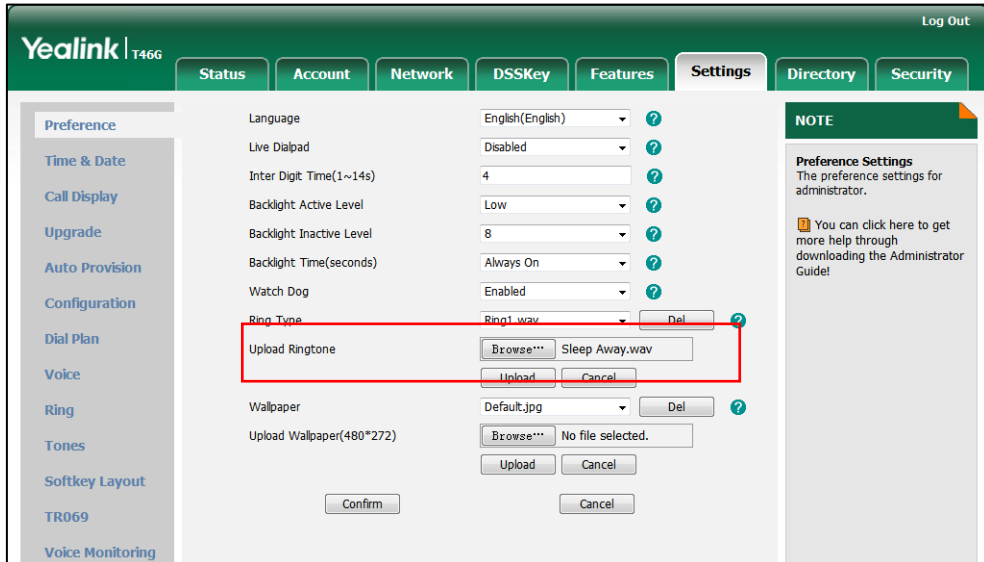

3. Click **Upload** to upload the file.

**Note**

All custom ring tone files must be no greater than 100KB. Uploading custom ring tones for your phone is configurable via web user interface only.

## Contact Management





This section provides the operating instructions for managing contacts. Topics include:

- [Directory](#)
- [Local Directory](#)
- [Blacklist](#)
- [Remote Phone Book](#)

## Directory

Directory provides easy access to frequently used lists. The lists may contain Local Directory, History, Remote Phone Book and LDAP.

To configure the directory via web user interface:

1. Click on **Directory->Setting**.
2. In the **Directory** block, select the desired list from the **Disabled** column and then click  .  
The selected list appears in the **Enabled** column.
3. Repeat step 2 to add more lists to the **Enabled** column.
4. To remove a list from the **Enabled** column, select the desired list and then click  .
5. To adjust the display order of enabled lists, select the desired list and then click  or  .

The LCD screen will display the list(s) in the adjusted order.

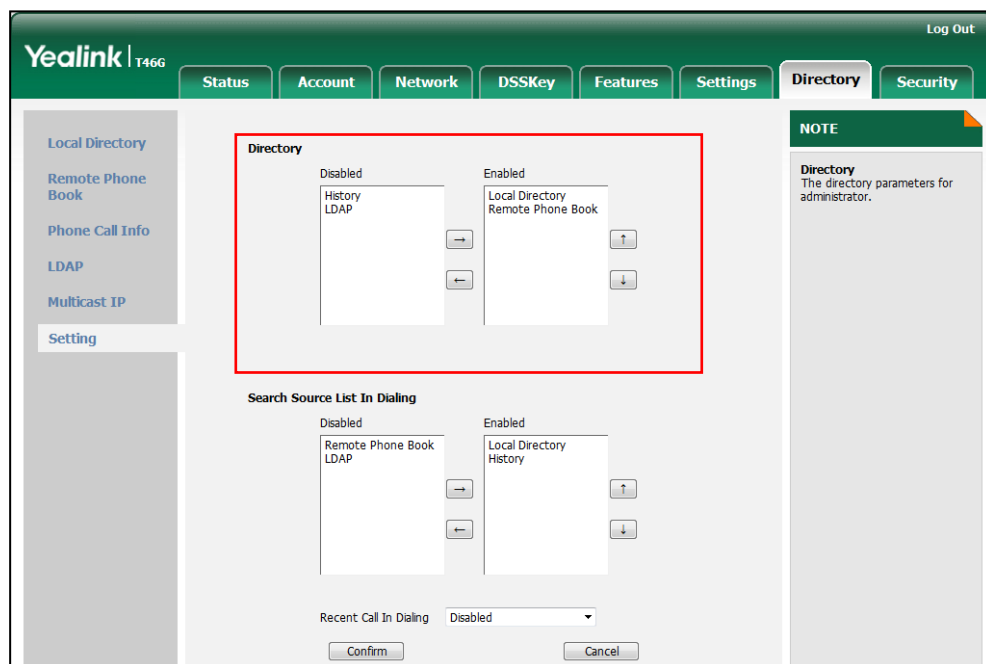

6. Click **Confirm** to accept the change.

### Note

Directory is configurable via web user interface only.

**To view the directory via phone user interface:**

1. Press the **Directory** soft key when the phone is idle.

The LCD screen displays the enabled list(s) in the directory.



If there is only one list in the directory, press the **Directory** soft key to enter this list directly.

**Note**

If the remote phone book and LDAP are not configured in advance, you cannot see remote phone book and LDAP lists on the phone user interface. For more information on remote phone book, refer to [Remote Phone Book](#) on page 51. For more information on the LDAP, refer to *Yealink\_SIP-T4X\_IP\_Phones\_Administrator\_Guide*.

## Local Directory

The built-in phone directory can store the names and phone numbers of your contacts. You can store up to 1000 contacts and 50 groups in your phone's local directory. There are four default groups in the local directory: All Contacts, Company, Family and Friend. You can add new groups and contacts, edit, delete or search for a contact, or simply dial a contact number from the local directory.

## Groups



**To add a group to the local directory:**

1. Press the **Directory** soft key.

The IP phone enters the local directory directly as there is only Local Directory enabled in the directory by default.



If Local Directory is removed from the directory, press **Menu->Directory->Local Directory** to enter the local directory.

2. Press the **Add Group** soft key.
3. Enter the desired group name in the **Name** field.
4. Press  or  to select the desired group ring tone from the **Ring Tones** field.

If **Auto** is selected, this group will use the ring tone specified for the contact. If no ring tone is specified for the contact, it will then play the ring tone specified for the account. For more information on the ring tone for the account, refer to [Ring Tones](#) on page 32.



5. Press the **Save** soft key to accept the change or the **Back** soft key to cancel.

You can also edit or delete the Company, Family, Friend and any newly added contact groups.

**To edit a group in the local directory:**

1. Press the **Directory** soft key.

The IP phone enters the local directory directly as there is only Local Directory enabled in the directory by default.



If Local Directory is removed from the directory, press **Menu->Directory->Local Directory** to enter the local directory.

2. Select the desired contact group.
3. Press the **Option** soft key and then select **Detail** from the prompt list.



4. Press **▲** or **▼** to highlight the group information and then edit.
5. Press the **Save** soft key to accept the change or the **Back** soft key to cancel.

**To delete a group from the local directory:**

1. Press the **Directory** soft key.

The IP phone enters the local directory directly as there is only Local Directory enabled in the directory by default.



If Local Directory is removed from the directory, press **Menu->Directory->Local**

**Directory** to enter the local directory.

2. Select the desired contact group.
3. Press the **Option** soft key and then select **Delete** from the prompt list.

The LCD screen prompts the following warning:

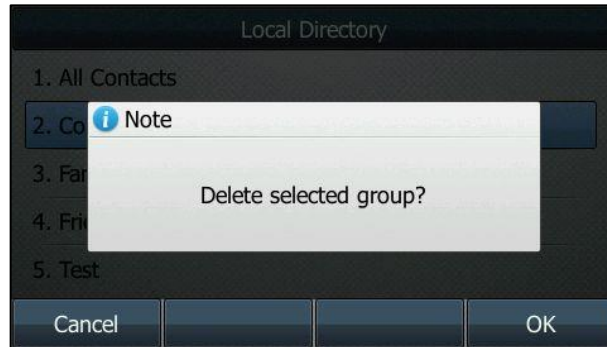

4. Press the **OK** soft key to confirm the deletion or the **Cancel** soft key to cancel.

## Adding Contacts

You can add contacts to the local directory in one of the following ways:

- Manually
- From call history
- From a remote phone book

### Adding Contacts Manually

To add a contact to the local directory manually:

1. Press the **Directory** soft key.

The IP phone enters the local directory directly as there is only Local Directory enabled in the directory by default.



If Local Directory is removed from the directory, press **Menu->Directory->Local Directory** to enter the local directory.

2. Select the desired contact group and then press the **Enter** soft key.

3. Press the **Add** soft key.
4. Enter the name and the office, mobile or other numbers in the corresponding fields.

The screenshot shows the 'Add Contact' interface. It has a title bar 'Add Contact' and five input fields. The first field is '1. Name:' with the value 'A'. The second is '2. Office Number:' with '123'. The third is '3. Mobile:' which is currently selected and highlighted in blue. The fourth is '4. Other Number:'. The fifth is '5. Account:' with 'Auto' and navigation arrows. At the bottom, there are four buttons: 'Back', '123', 'Delete', and 'Save'.

5. Press  $\leftarrow$  or  $\rightarrow$ , or the **Switch** soft key to select the desired account from the **Account** field.  
If **Auto** is selected, the phone will use the first available account when placing calls to the contact from the local directory.
6. Press  $\leftarrow$  or  $\rightarrow$ , or the **Switch** soft key to select the desired ring tone from the **Ring** field.  
If **Auto** is selected, this contact will use the ring tone assigned to the group.
7. Highlight **Photo** and then press the **Enter** soft key.
8. Press  $\leftarrow$  or  $\rightarrow$ , or the **Switch** soft key to select the desired photo from the **Photo** field.
9. Press the **Save** soft key to accept the change or the **Back** soft key to cancel.

**Note**

If the contact already exists in the directory, the LCD screen will prompt "Contact name existed!".

## Adding Contacts from Call History

To add a contact to the local directory from call history:

1. Press the **History** soft key.
2. Press  $\uparrow$  or  $\downarrow$  to highlight the desired entry.



- Press the **Option** soft key, and then select **Add to Contacts** from the prompt list.

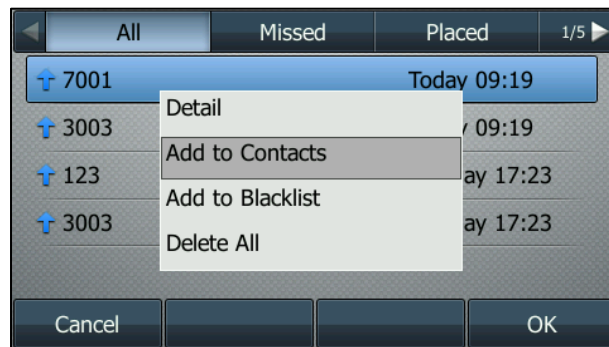

- Enter the contact name.
- Press the **Save** soft key to accept the change.

The entry is successfully saved to the local directory.

## Adding Contacts from remote phone book

To add a contact to the local directory from a remote phone book:

- Press **Directory->Remote Phone Book**.  
If Remote Phone Book is removed from the directory, press **Menu->Directory->Remote Phone Book** to enter the remote phone book.
- Select the desired remote group and then press the **Enter** soft key.
- Press **▲** or **▼** to highlight the desired entry.
- Press the **Option** soft key, and then select **Add to Contacts** from the prompt list.
- Press the **Save** soft key to save the contact to the local directory.

If the contact already exists in the local directory, the LCD screen will prompt "Overwrite the original contact?". Press the **OK** soft key to overwrite the original contact in the local directory or the **Cancel** soft key to cancel.

For more information on remote phone book operating, refer to [Remote Phone Book](#) on page 51.

## Editing Contacts



To edit a contact in the local directory:

- Press the **Directory** soft key.



The IP phone enters the local directory directly as there is only Local Directory enabled in the directory by default.



If Local Directory is removed from the directory, press **Menu->Directory->Local Directory** to enter the local directory.

2. Select the desired contact group and then press the **Enter** soft key.
3. Press  or  to highlight the desired contact.
4. Press the **Option** soft key, and then select **Detail** from the prompt list.



5. Press  or  to highlight the contact information and then edit.
6. Press the **Save** soft key to accept the change or the **Back** soft key to cancel.

## Deleting Contacts

To delete a contact from the local directory:

1. Press the **Directory** soft key.

The IP phone enters the local directory directly as there is only Local Directory enabled in the directory by default.



If Local Directory is removed from the directory, press **Menu->Directory->Local Directory** to enter the local directory.

2. Select the desired contact group and then press the **Enter** soft key.
3. Press  $\uparrow$  or  $\downarrow$  to highlight the desired contact.
4. Press the **Option** soft key, and then select **Delete** from the prompt list.

The LCD screen prompts the following warning:

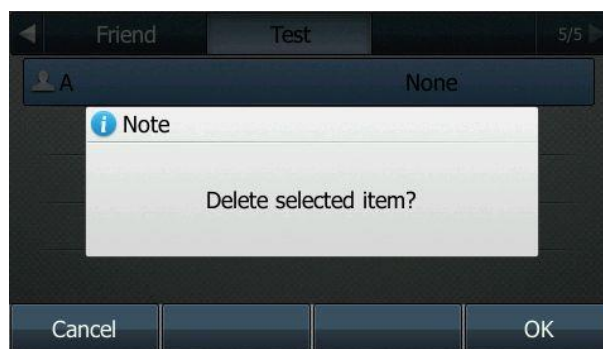

5. Press the **OK** soft key to confirm the deletion or the **Cancel** soft key to cancel.

You can also delete all contacts by pressing the **Option** soft key, and then select **Delete All**.

## Uploading Contact Photos

To upload a new custom photo for the contact via web user interface:

1. Click on **Directory->Local Directory**.
2. Click **Browse**, and then select a photo from your local computer.
3. Click **Upload Photo** to upload the photo.

You can also click **Delete Photo** to delete the photo.

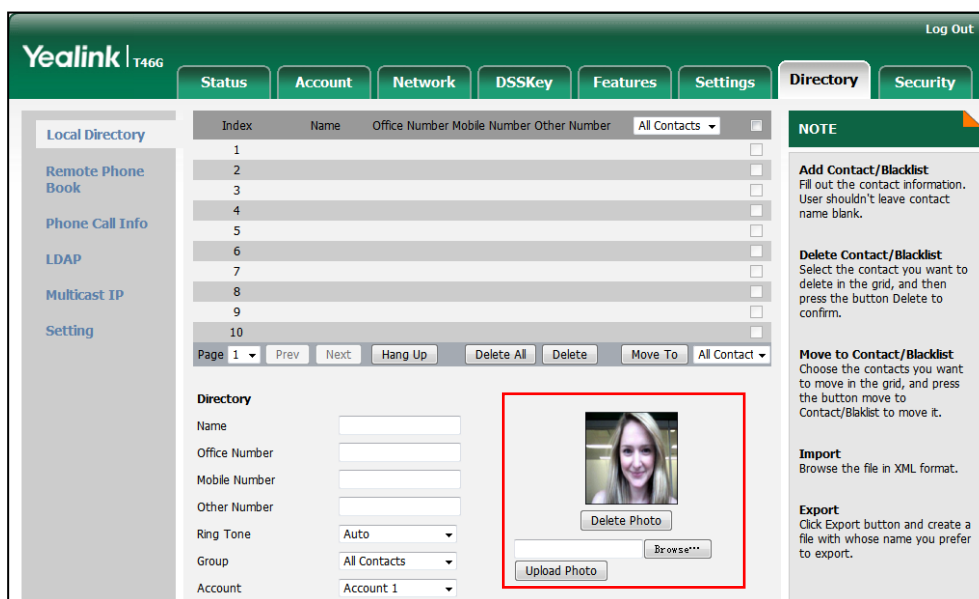

**Note** The phone only supports \*.png, \*.jpg and \*.bmp format files.  
You can only delete custom photos.

**To change the custom photo for the contact via web user interface:**

1. Click on **Directory->Local Directory**.
2. Click to select the desired entry which you want to edit.
3. Select the desired photo from the pull-down list of **Photo**.
4. Click **Edit** to accept the change.

When you place a call to the contact or receive a call from the contact, the LCD screen will show the contact photo.

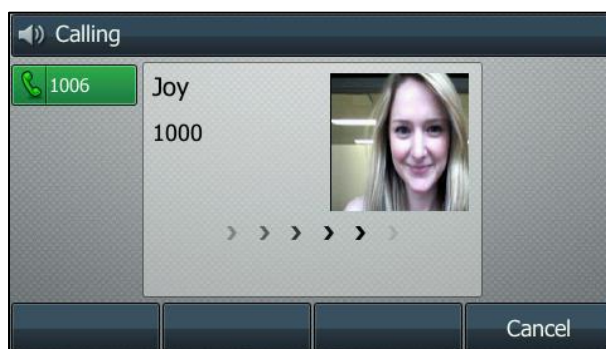

## Placing Calls to Contacts





To place a call to a contact from the local directory:

1. Press the **Directory** soft key.

The IP phone enters the local directory directly as there is only Local Directory enabled in the directory by default.



If Local Directory is removed from the directory, press **Menu->Directory->Local Directory** to enter the local directory.

2. Select the desired contact group and then press the **Enter** soft key.
3. Press  or  to highlight the desired contact.
4. Do one of the following:
  - If only one number for the contact is stored in the local directory, press the **Send** soft key to dial out the number.
  - If multiple numbers for the contact are stored in the local directory, press the **Send** soft key to display a list of numbers.  
Press  or  to highlight the desired number.  
Press the **Send** soft key to dial out the number.

## Searching for Contacts

To search for a contact in the local directory:

1. Press the **Directory** soft key.

The IP phone enters the local directory directly as there is only Local Directory enabled in the directory by default.



If Local Directory is removed from the directory, press **Menu->Directory->Local Directory** to enter the local directory.

2. Press the **Search** soft key.
3. Enter a few continuous characters of the contact name or continuous numbers of the contact number (office, mobile or other number) using the keypad.

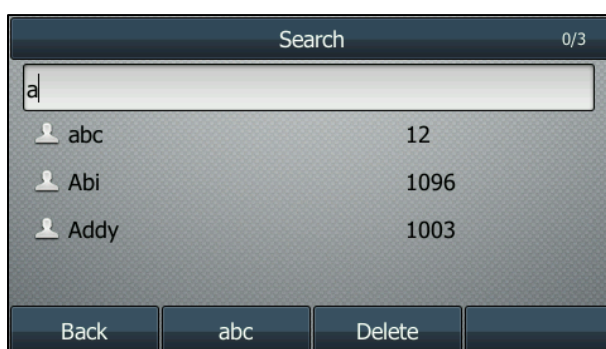

The contacts whose name or phone number matches the characters entered will appear on the LCD screen. You can dial from the result list.



## Search Source List in Dialing

You can search for a contact from the desired lists when the phone is in the dialing screen. The lists can be Local Directory, History, Remote Phone Book and LDAP.

**To configure search source list in dialing via web user interface:**

1. Click on **Directory->Setting**.
2. In the **Search Source List In Dialing** block, select the desired list from the **Disabled** column and click .

The selected list appears in the **Enabled** column.

3. Repeat step 2 to add more lists to the **Enabled** column.
4. To remove a list from the **Enabled** column, select the desired list and then click .
5. To adjust the display order of the enabled list, select the desired list, and click .

or  .

The LCD screen will display search results in the adjusted order.

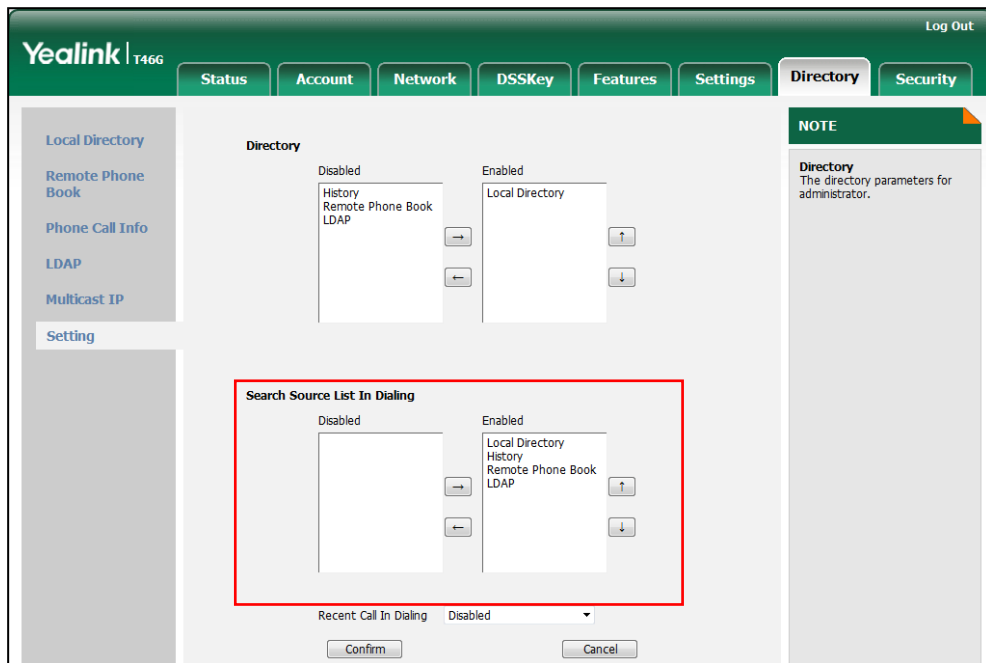



6. Click **Confirm** to accept the change.

**Note**

Search source list in dialing is configurable via web user interface only.

**To search for an entry in the enabled search source lists:**

1. Pick up the handset, press the speakerphone key or press the line key.
2. Enter a few continuous characters of the entry's name or continuous numbers of the entry's phone number (office, mobile or other number) using the keypad.

The entries in the enabled search source lists whose name or phone number matches the characters entered will appear on the LCD screen. You can press  or  to scroll to the desired entry and then place a call to the entry.

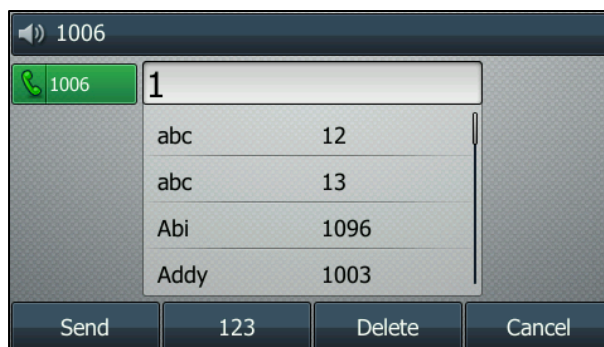

## Importing/Exporting Contact Lists

You can manage your phone's local directory via phone user interface or web user interface. But you can only import or export the contact list via web user interface.

### To import an XML contact list file via web user interface:

1. Click on **Directory->Local Directory**.
2. Click **Browse** to locate a contact list file (the file format must be \*.xml) from your local system.

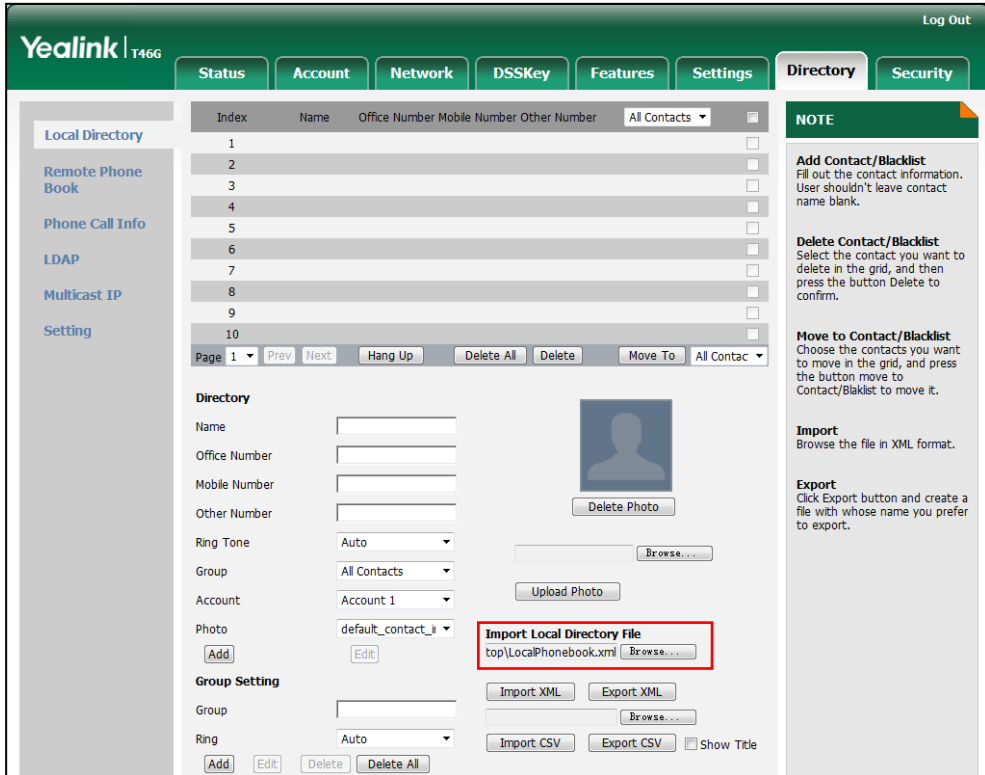

3. Click **Import XML** to import the contact list.

The web user interface prompts "The original contact will be covered, Continue?".

4. Click **OK** to complete importing the contact list.

### To import a CSV contact list file via web user interface:

1. Click on **Directory->Local Directory**.
2. Click **Browse** to locate a contact list file (the file format must be \*.csv) from your local system.

3. (Optional.) Check the **Show Title** checkbox.

It will prevent importing the title of the contact information which is located in the first line of the CSV file.

4. Click **Import CSV** to import the contact list.

5. (Optional.) Mark the **On** radio box in the **Delete Old Contacts** field.

It will delete all existing contacts while importing the contact list.



- (Optional.) Select the contact information you want to import into the local directory from the pull-down list of **Index**.

At least one item should be selected to be imported into the local directory.

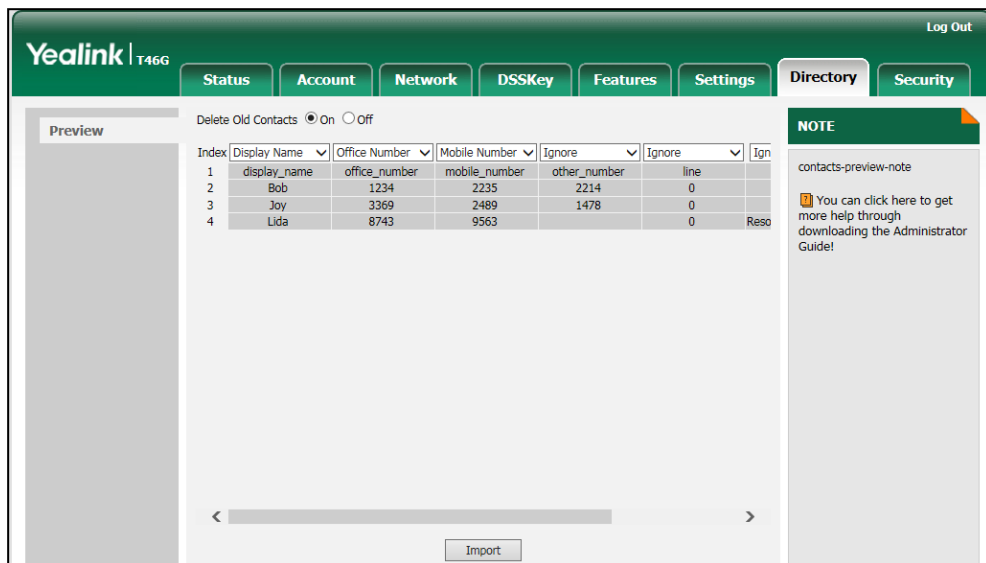

- Click **Import** to complete importing the contact list.

**To export a contact list via web user interface:**

- Click on **Directory->Local Directory**.
- Click **Export XML** (or **Export CSV**).
- Click **Save** to save the contact list to your local system.

#### Note

Importing/exporting contact lists is available via web user interface only.

## Blacklist

The built-in phone directory can store names and phone numbers for a blacklist. You can store up to 30 contacts, add, edit, delete or search for a contact in the blacklist directory, and even call a contact from the blacklist directory. Incoming calls from blacklist directory contacts will be rejected automatically.

**To add a contact to the blacklist directory manually:**

- Press **Menu->Directory ->Blacklist**.
- Press the **Add** soft key.

3. Enter the name and the office, mobile or other numbers in the corresponding fields.

4. Press or , or the **Switch** soft key to select the desired account from the **Account** field.

If **Auto** is selected, the phone will use the first available account when placing calls to the contact from the blacklist directory.

5. Press the **Save** soft key to accept the change or the **Back** soft key to cancel.

**To add a contact to the blacklist directory from the local directory:**

1. Press **Directory** soft key.

The IP phone enters the local directory directly as there is only Local Directory enabled in the directory by default.

If Local Directory is removed from the directory, press **Menu->Directory->Local Directory** to enter the local directory.

2. Select the desired contact group and then press the **Enter** soft key.
3. Press or to highlight the desired contact.
4. Press the **Option** soft key and then select **Add to Blacklist** from the prompt list.

The LCD screen prompts the following warning:

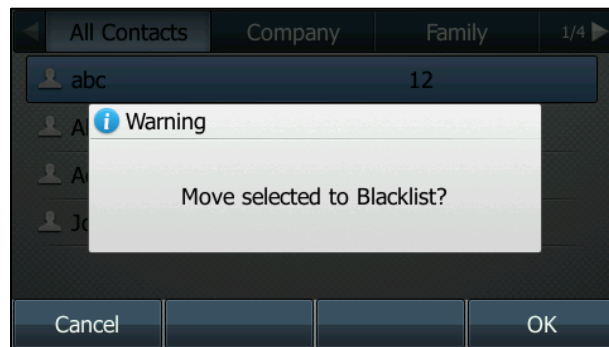

5. Press the **OK** soft key to confirm the setting.

For operating instructions on editing, deleting, placing calls to and/or searching for contacts in the blacklist directory, refer to the operating instructions of [Local Directory](#) on page 36.

## Remote Phone Book

You can add new contacts to the local directory, search for a contact, or simply dial a contact number from the remote phone book.

You can configure your new phone to access up to 5 remote phone books. All remote phone books must be less than 0.5MB in size. For the access URL of the remote phone book, contact your system administrator.

**To configure an access URL for a remote phone book via web user interface:**

1. Click on **Directory->Remote Phone Book**.
2. Enter the access URL in the **Remote URL** field.
3. Enter the name in the **Display Name** field.

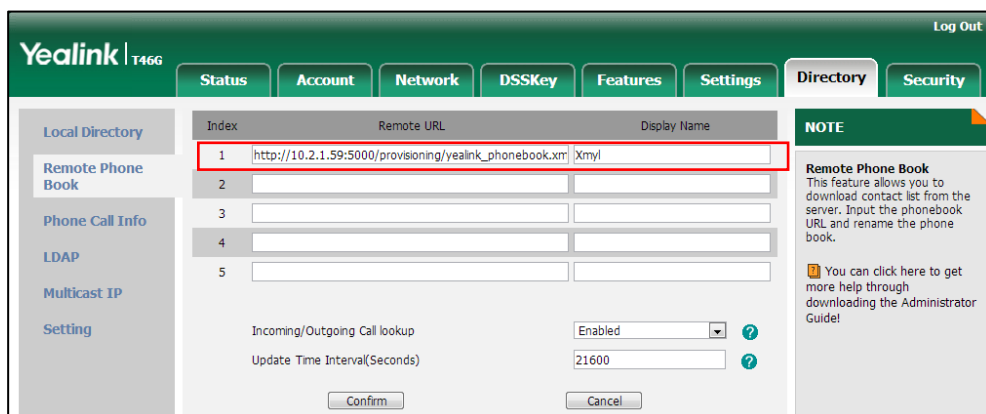

4. Click **Confirm** to accept the change.

### Note

An access URL for a remote phone book is configurable via web user interface only.

**To access your remote phone book via phone user interface:**

1. Press **Directory->Remote Phone Book**.

If Remote Phone Book is removed from the directory, press

**Menu->Directory->Remote Phone Book** to enter the remote phone book.

2. Select the desired remote group, and then press the **Enter** soft key.

The phone then connects to the remote phone book and proceeds to load it. The contacts in the remote phone book are displayed on the LCD screen.

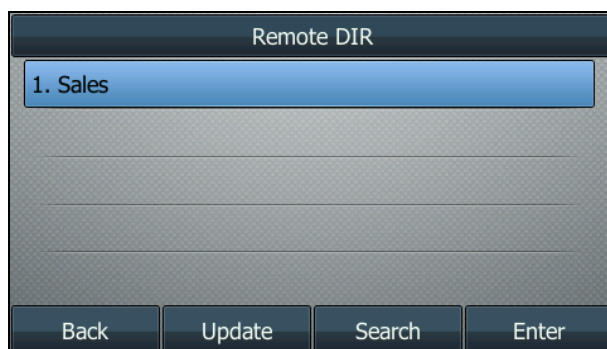

3. Press the **Back** soft key to back to the previous interface.

**To search for a contact in the remote phone book:**

1. Press **Menu->Directory->Remote Phone Book**.

If Remote Phone Book is added to the directory, press **Directory->Remote Phone Book** to enter the remote phone book.

2. Select the desired remote group, and then press the **Enter** soft key to load the remote phone book.

3. Press the **Search** soft key.

4. Enter a few continuous characters of the contact name or continuous numbers of the contact number using the keypad.

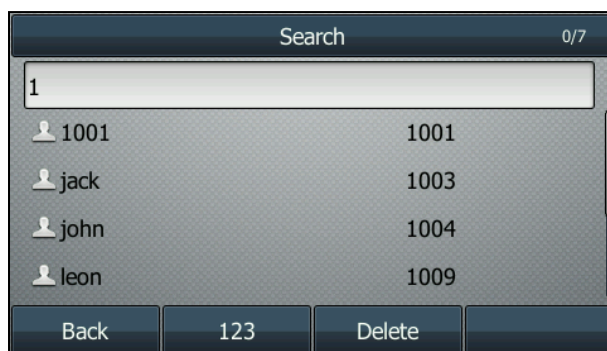

The contacts whose name or phone number matches the characters entered will appear on the LCD screen. You can place a call from the result list.

To place a call from the remote phone book:

1. Press **Menu->Directory->Remote Phone Book**.

If Remote Phone Book is added to the directory, press **Directory->Remote Phone Book** to enter the remote phone book.

2. Select the desired remote group, and then press the **Enter** soft key to load the remote phone book.
3. Select the desired contact in the remote phone book.
4. Press the **Send** soft key.

In addition, you can enable the phone to present the caller identity stored in the remote phone book when receiving a call.

To enable the presentation of a caller identity stored in remote phone book via web user interface:

1. Click on **Directory->Remote Phone Book**.
2. Select **Enabled** from the pull-down list of **Incoming/Outgoing Call lookup**.
3. Enter the desired refresh period in the **Update Time Interval (Seconds)** field.

The default value is 21600 seconds.

The screenshot shows the Yealink T46G web interface. The 'Directory' tab is selected, and the 'Remote Phone Book' configuration page is displayed. The page has a table with columns for Index, Remote URL, and Display Name. Below the table, there are two configuration fields: 'Incoming/Outgoing Call lookup' with a dropdown menu set to 'Enabled', and 'Update Time Interval(Seconds)' with a text input field containing '21600'. A red box highlights these two fields. To the right of the configuration fields, there is a 'NOTE' section with the following text: 'Remote Phone Book This feature allows you to download contact list from the server. Input the phonebook URL and rename the phone book. You can click here to get more help through downloading the Administrator Guide!'. At the bottom of the page, there are 'Confirm' and 'Cancel' buttons.

4. Click **Confirm** to accept the change.



## Call History Management

The SIP-T46G IP phone maintains call history lists of Missed calls, Placed calls, Received calls and Forwarded calls. Call history lists support 400 entries in all. You can view call history, place a call, add a contact or delete an entry from the call history list.

History record feature is enabled by default. If you don't want to save the call history, you can disable the feature.

To disable history record via phone user interface:



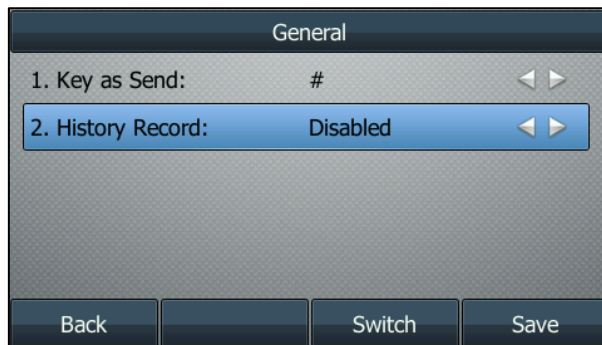

1. Press **Menu->Features->Others->General**.

- Press  or  , or the **Switch** soft key to select **Disabled** from the **History Record** field.







- Press the **Save** soft key to accept the change or the **Back** soft key to cancel.





#### To view call history:

- Press the **History** soft key.  
The LCD screen displays all call records.
- Press  or  to switch between **All Calls**, **Missed**, **Placed**, **Received** and **Forwarded** call lists.
- Press  or  to select the desired entry.
- Press the **Option** soft key, and then select **Detail** from the prompt list.  
The detailed information of the entry appears on the LCD screen.

#### To place a call from the call history list:





- Press the **History** soft key.
- Press  or  to switch between **All Calls**, **Missed**, **Placed**, **Received** and **Forwarded** call lists.
- Press  or  to select the desired entry.
- Press the **Send** soft key.

#### To add a contact to the local directory (or blacklist directory) from the call history list:



- Press the **History** soft key.
- Press  or  to switch between **All Calls**, **Missed**, **Placed**, **Received** and **Forwarded** call lists.
- Press  or  to select the desired entry.
- Press the **Option** soft key, and then select **Add to Contacts** (or **Add to Blacklist**) from the prompt list.
- Enter the desired values in the corresponding fields.
- Press the **Save** soft key.

For more information, refer to [Contact Management](#) on page 34.

**To delete an entry from the call history list:**

1. Press the **History** soft key.
2. Press  or  to switch between **All Calls**, **Missed**, **Placed**, **Received** and **Forwarded** call lists.
3. Press  or  to select the desired entry.
4. Press the **Delete** soft key.

**To delete all entries from the call history list:**

1. Press the **History** soft key.
2. Press  or  to switch between **All Calls**, **Missed**, **Placed**, **Received** and **Forwarded** call lists.
3. Press the **Option** soft key, and then select **Delete All** from the prompt list.
4. Press the **OK** soft key.

The LCD screen prompts "Delete all the call records?".

5. Press the **OK** soft key to confirm the deletion or the **Cancel** soft key to cancel.

## System Customizations

### Headset Use

If you want to use a wired headset, physically connect your headset and activate the headset mode for use. For more information on physically connecting a headset, refer to [Phone Installation](#) on page 11.

If you want to use a wireless headset, insert the Bluetooth USB dongle into the USB port on the back of the phone. For more information on using a Bluetooth headset, refer to [Bluetooth Headset](#) on page 57.

This section provides an introduction to wired headset use.

#### Note

If both a Bluetooth headset and a wired headset are connected, only the Bluetooth headset can be used.

### Headset Mode Activation/Deactivation

**To activate the headset mode:**

1. Press  on the phone.

The HEADSET key LED illuminates solid green when the headset mode is activated.

Press the line key or the **Answer** soft key to answer an incoming call. The call will be connected to your headset automatically.

Enter the desired number and then press the **Send** soft key, the phone will then

place a call using the headset automatically. For more information on using the headset to place a call, refer to [Placing Calls](#) on page 87.

**To deactivate the headset mode:**

1. Press  again on the phone.  
The HEADSET key LED goes out when the headset mode is deactivated.

## Headset Prior

You can use headset in priority when headset prior feature is enabled. This feature is especially useful for permanent or full-time headset users.

**To enable headset prior via web user interface:**

1. Click on **Features->General Information**.
2. Select **Enabled** from the pull-down list of **Headset Prior**.

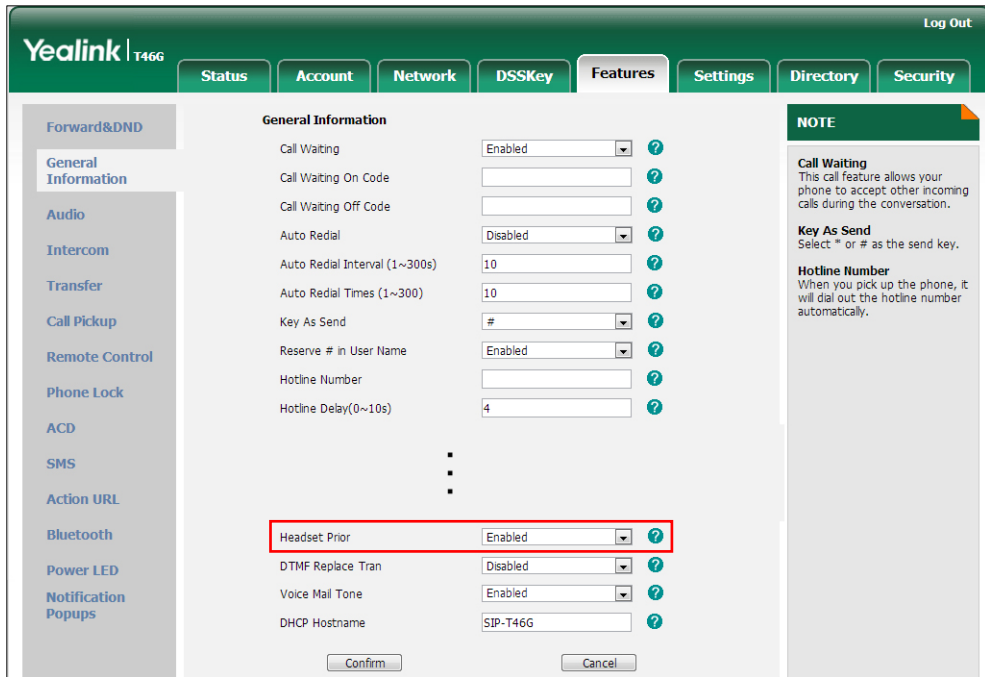

3. Click **Confirm** to accept the change.

**To use headset prior, you should activate the headset mode in advance:**

1. Physically connect the headset.
2. Press  to activate the headset mode.

**Note**

If headset prior is enabled, the headset mode will not be deactivated until you press the **HEADSET** key again.

If headset prior is disabled, the headset mode can be deactivated by pressing the speakerphone key or the **HEADSET** key.

Headset prior is configurable via web user interface only.



## Dual Headset

You can use two headsets when dual headset feature is enabled. To use this feature, you must physically connect headsets to the headset jack and handset jack respectively. Once the phone connects to a call, the headset connected to the headset jack will have full-duplex capabilities, while the one connected to the handset jack will only be able to listen.

To enable dual headset via web user interface:

1. Click on **Features->General Information**.
2. Select **Enabled** from the pull-down list of **Dual-Headset**.

The screenshot shows the Yealink T46G web user interface. The 'Features' tab is selected, and the 'General Information' sub-tab is active. The 'Dual-Headset' option is highlighted with a red box and is set to 'Enabled'. Other settings include Call Waiting (Enabled), Auto Redial (Disabled), and Hotline Number (empty). A 'NOTE' section on the right provides information about Call Waiting, Key As Send, and Hotline Number.

Setting	Value
Call Waiting	Enabled
Call Waiting On Code	
Call Waiting Off Code	
Auto Redial	Disabled
Auto Redial Interval (1~300s)	10
Auto Redial Times (1~300)	10
Key As Send	#
Reserve # in User Name	Enabled
Hotline Number	
Hotline Delay(0~10s)	4
Dual-Headset	Enabled
Auto-Answer Delay(1~4s)	3
Voice Mail Tone	Enabled
DHCP Hostname	SIP-T46G

3. Click **Confirm** to accept the change.

### Note

Dual headset is configurable via web user interface only.

## Bluetooth Headset

The SIP-T46G IP phone supports Bluetooth. Bluetooth enables low-bandwidth wireless connections within a range of 10 meters (32 feet). The best performance is in the 1 to 2 meter (3 to 6 feet) range.

You can activate/deactivate the Bluetooth mode, and then pair and connect the Bluetooth headset with your phone. You can pair up to 30 Bluetooth headsets with your phone; however, only one headset can be connected at a time. You can also disconnect and delete your Bluetooth headset from the phone.

**Note**

Ensure that the Bluetooth USB dongle is properly connected to the USB port on the back of the phone. For more information, refer to [Phone Installation](#) on page 11.

**To activate the Bluetooth mode via phone user interface:**

1. Press **Menu->Basic->Bluetooth**.
2. Press  or  , or the **Switch** soft key to select **On** from the **Bluetooth** field.



3. Press the **Save** soft key to accept the change.

The LCD screen displays the Bluetooth icon .

Before you pair a Bluetooth headset, check the indicator on the Bluetooth headset to make sure that the Bluetooth headset is discoverable. For more information, refer to the documentation from the Bluetooth headset manufacturer.

**To pair and connect your Bluetooth headset to your phone:**

1. Press **Menu->Basic->Bluetooth**.
2. Press the **Scan** soft key to search the Bluetooth devices.

The LCD screen prompts the following message:

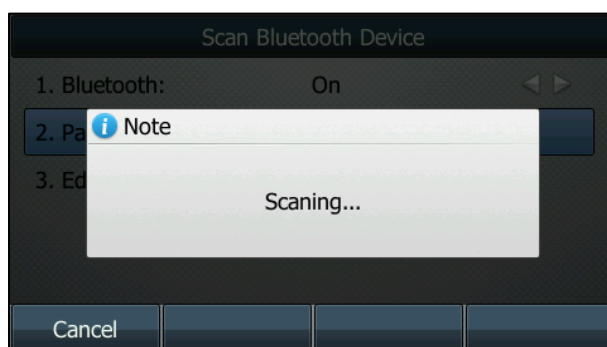

The phone proceeds to scan the local Bluetooth devices. When the phone completes scan, it will display the found Bluetooth devices on the LCD screen.



3. Select the desired Bluetooth headset and then press **Connect** soft key.
4. Enter the PIN in the **Password** field.  
The default PIN is "0000" or "1234".

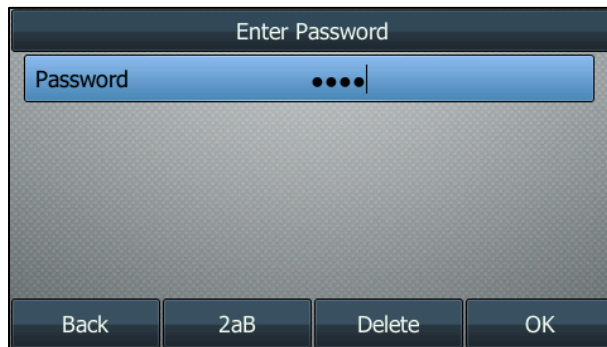

5. Press the **OK** soft key.  
The Bluetooth headset is then automatically connected to your phone.  
The Bluetooth icon  appears on the LCD screen.



With the Bluetooth headset paired and connected, you can use the Bluetooth headset to place and answer calls. For more information, refer to the documentation from the Bluetooth headset manufacturer.

**To view the Bluetooth headset information:**

1. Press **Menu->Basic->Bluetooth->Paired Bluetooth Device**.

The LCD screen displays a list of paired and connected Bluetooth headsets.

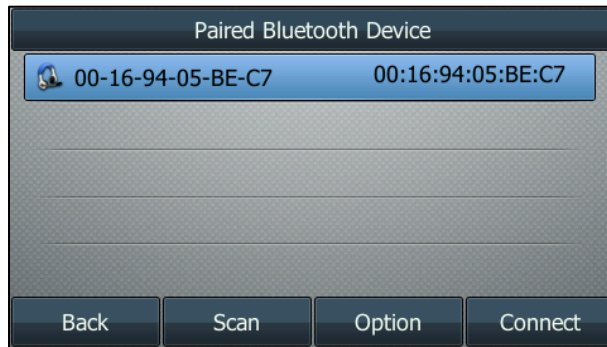

2. Select the desired Bluetooth headset.
3. Press the **Option** soft key, and then select **Detail** from the prompt list to view the Bluetooth headset information:
  - **Device Name:** the name of the Bluetooth headset.
  - **MAC Address:** the MAC address of the Bluetooth headset.
  - **Auto Connection:** Enables or disables the Bluetooth headset to connect with the phone automatically.

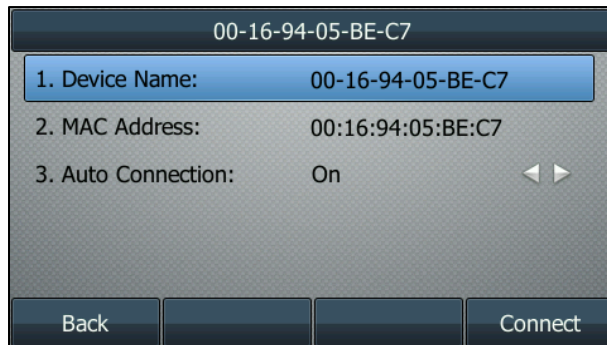

**To change the priority of paired Bluetooth devices:**

1. Press **Menu->Basic->Bluetooth->Paired Bluetooth Device**.
2. Select the desired Bluetooth headset.
3. Press the **Option** soft key, and then select **Move Up** or **Move Down** from the prompt list.

The top device has the highest priority. If there is no Bluetooth headset connected, the phone will automatically connect to the Bluetooth headset with the highest priority.

You can disconnect the Bluetooth headset from your phone. After you disconnect the Bluetooth headset, it will still remain paired and be displayed in the **Paired Bluetooth Device** list. So you can easily connect it to your phone again.

**To disconnect your Bluetooth headset from your phone:**

1. Press **Menu->Basic->Bluetooth->Paired Bluetooth Device**.

2. Select the connected Bluetooth headset.
3. Press the **Disconnect** soft key.

The Bluetooth headset is disconnected. To connect it to your phone again, press the **Connect** soft key.

You can delete your Bluetooth headset from your phone. When you delete the Bluetooth headset, it disappears from the **Paired Bluetooth Device** list. To connect it to your phone again, you need to scan and connect it again.

**To delete your Bluetooth headset from your phone:**

1. Press **Menu->Basic->Bluetooth->Paired Bluetooth Device**.
2. Select the Bluetooth headset you want to delete.
3. Press the **Option** soft key, and then select **Delete** from the prompt list.

The LCD screen prompts the following warning "Delete the selected item?".



4. Press the **OK** soft key to confirm the deletion or the **Cancel** soft key to cancel.

**Note**

You can also delete all headsets by pressing the **Option** soft key and then select **Delete All**. For more information, refer to the above steps.

If you cannot connect a Bluetooth headset to the phone successfully, we recommend that you delete the Bluetooth headset from the **Paired Bluetooth Device** list (if it exists) before pairing it.

**To deactivate the Bluetooth mode via phone user interface:**

1. Press **Menu->Basic->Bluetooth**.
2. Press  or  , or the **Switch** soft key to select **Off** from the **Bluetooth** field.



3. Press the **Save** soft key to accept the change.

The Bluetooth icon  disappears from the phone.

If a Bluetooth headset is paired and connected, and then you deactivate the Bluetooth mode, it will disappear from the **Bluetooth Devices** list. The Bluetooth headset won't be connected anymore, but it will still be paired. When you activate the Bluetooth mode again, the Bluetooth headset will be connected automatically if Auto Connection feature is enabled.

Bluetooth mode is configurable via web user interface at the path **Features->Bluetooth**.

## DSS Keys

There are three types of DSS keys: Line Keys, Programmable Keys and Ext Keys. Details will be introduced in the following. The SIP-T46G IP phone supports 27 line keys.

### Line Keys

You can assign predefined functionalities to line keys. You can also define a label for a line key feature which will appear on the LCD screen. Line keys allow you to quickly access features such as recall and voice mail. The line key LEDs will indicate the monitored status when the line keys are assigned with particular features, such as BLF. The default key type of line key 1-16 is Line. The default key type of line key 17-27 is N/A, which indicates that this line key provides no functionality until configuration.

**To assign functionality to a line key via phone user interface:**

1. Press **Menu->Features->DSS Keys**.
2. Select the desired line key, and then press the **Enter** soft key.
3. Select the desired key type from the **Type** field.
4. (Optional.) Select the desired key event type from the **Key Type** field.
5. (Optional.) Select the desired line from the **Account ID** field.
6. (Optional.) Enter a string that will appear on the LCD screen in the **Label** field.
7. (Optional.) Enter the corresponding value in the **Value** field.
8. (Optional.) Enter the corresponding value in the **Extension** field.
9. Press the **Save** soft key to accept the change or the **Back** soft key to cancel.

Line key is configurable via web user interface at the path **DSSKey->Line Key**.

#### Note

When the phone is idle, you can also long press the line key to configure it directly on the phone.

You can assign functionalities to 27 line keys. These 27 line keys are indicated on three pages. When you assign functionality to line keys located in line key 1-10, the labels of line keys are indicated on the first page. The following figure shows an example:

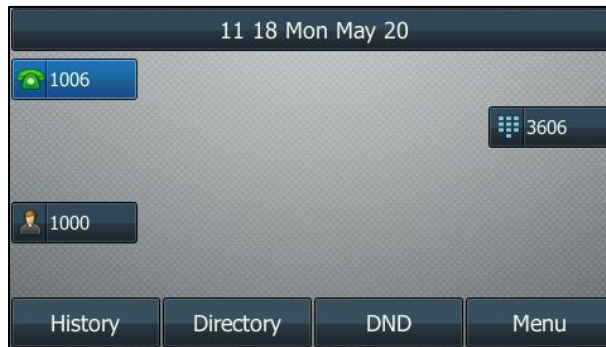

When you assign functionality to line key located in line key 11-27, the label of the line key 10-18 are indicated on the second page, and the labels of the line key 19-27 are indicated on the third page. The right bottom line key is used to switch pages. The following figure shows an example:

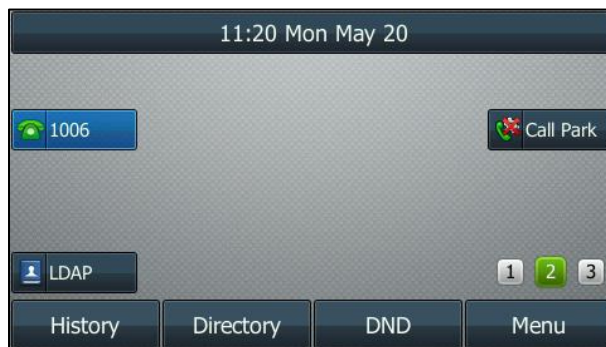

The following table lists the page icon status:

Icons	Description
	Indicates the current page of line keys.
	Indicates the non-current page of line keys.

## Page Tips

You can configure the page icon and page switch key LED to indicate different statuses. This feature is disabled by default.

The following table lists the page icon status to indicate different statuses:

Icons	Description
	Fast flashing: the BLF monitored user receives an incoming

Icons	Description
	call on the non-current page. Solid: there is a parked call on the non-current page.
1	Fast flashing: the line receives an incoming call on the non-current page.

For more information on the page switch key LED status, refer to [LED Instructions](#) on page 4.

To configure the page icon to indicate status via web user interface:

1. Click on **DSSKey->Line Key**.
2. Select **Enabled** from the pull-down list of **Enable Page Tips**.

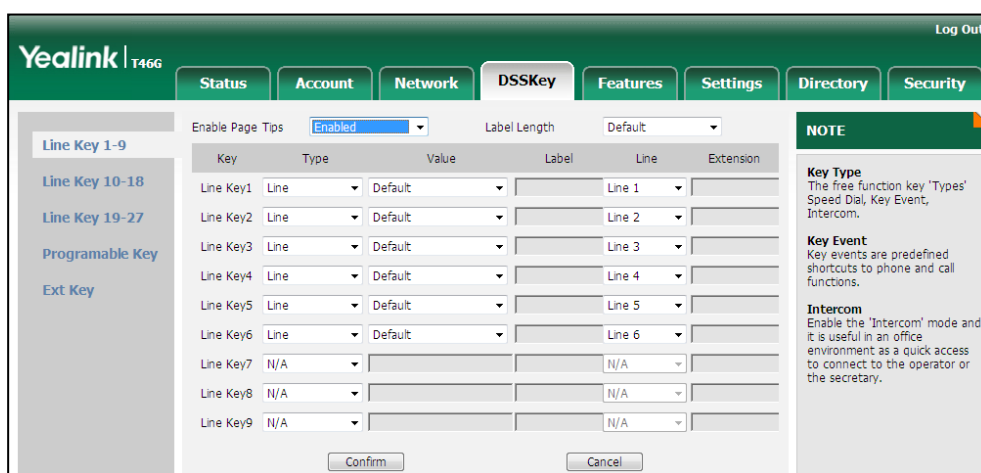

3. Click **Confirm** to accept the change.

## Label Length

You can specify labels for some key features, which will be displayed on the idle LCD screen. If the length of the label exceeds the maximum display length, the phone only displays the first few characters. You can configure the phone to display more characters (up to 33) via label length feature.



The following figure shows an example of label display when the label length feature is enabled:



The following figure shows an example of label display when the label length feature is disabled:



To configure the label length via web user interface:

1. Click on **DSSKey->Line Key**.
2. Select **Extended** from the pull-down list of **Label Length**.

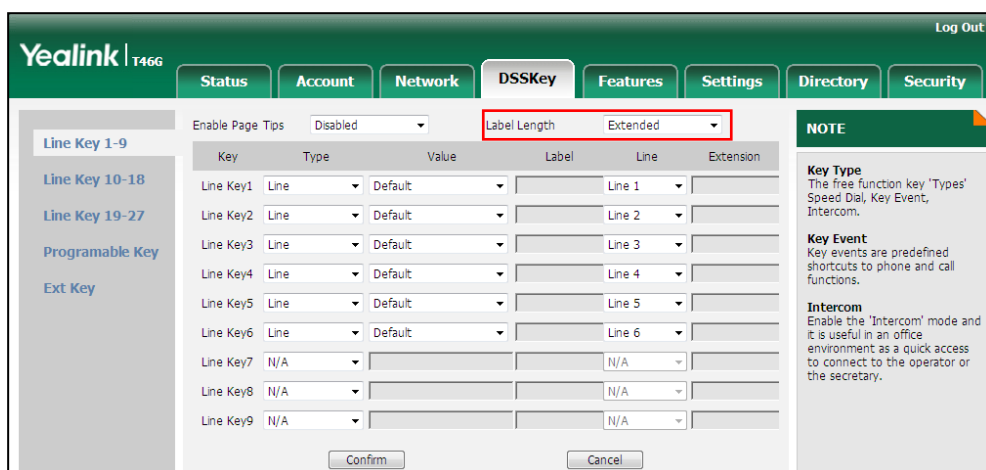

3. Click **Confirm** to accept the change.

**Note**

Page icon status and label length features are configurable via web user interface only.

Line key features are explained in the following subchapters in detail:

- Line
- Speed Dial
- Voice Mail
- Directed Pickup
- Group Pickup
- DTMF
- Prefix
- Local Group
- XML Group
- XML Brower
- LDAP
- Conference
- Forward
- Transfer
- Hold
- DND
- SMS
- Group Listening
- Zero Touch
- URL
- Phone Lock
- Directory

For the features not listed above, refer to [Basic Call Features](#) on page 87 and [Advanced Phone Features](#) on page 125. For more information, contact your system administrator.

### Line

You can use this key feature to accept incoming calls, place active calls on hold or resume a held call. It performs in the same way as a hard line key.

**Dependencies:** *Type (Line)*

*Account ID (the account this feature will be applied to)*

*Label (key label displayed on the LCD screen)*

*Value (Default/Lock/Float)*

**Usage:** When the phone receives an incoming call, the DSS key LED flashes green:

1. Press the DSS key to accept the incoming call.
2. Press the DSS key to place a new call and the active call is placed on hold.

3. Press the DSS key again to resume the held call.

If you select **Lock** from the **Value** field, the line keys located in the same position of the other page will be automatically assigned Line feature with **Lock** filled in the **Value** field. Then you can use this key on every page. This feature is only applicable to line key 1-9.

If you select **Float** from the **Value** field, the phone will automatically switch to the page the line key located, when the line key receives an incoming call.

If you select **Default** from the **Value** field, you can only use this key on the current page.

### Speed Dial

You can use this key feature to speed up dialing the numbers frequently used or hard to remember.

**Dependencies:** *Type (Speed Dial)*

*Account ID (the account this feature will be applied to)*

*Label (key label displayed on the LCD screen)*

*Value (the number you want to dial out)*

**Usage:** Press the DSS key to dial out the number specified in the **Value** field, using the account selected from the **Account ID** field.

### Voice Mail

You can use this key feature to quickly connect voice mail. For more information, refer to [Voice Mail](#) on page 147.

**Dependencies:** *Type (Key Event)*

*Key Type (Voice Mail)*

*Account ID (the account this feature will be applied to)*

*Label (key label displayed on the LCD screen)*

*Value (the voice mail access code)*

**Usage:** Press the DSS key to dial out the voice mail access code. Then follow the voice prompt to listen to the voice mails.

### Directed Pickup

You can use this key feature to answer someone else's incoming call on the phone.

**Dependencies:** *Type (Key Event)*

*Key Type (DPickup)*

*Account ID (the account this feature will be applied to)*

*Label (key label displayed on the LCD screen)*

*Value (the directed pickup code followed by the target phone number)*

**Usage:** Press the DSS key on your phone when the target phone number receives an incoming call. The call is then answered on your phone.

### Group Pickup

You can use this key feature to answer incoming calls in a group that is associated with their own group.

**Dependencies:** *Type (Key Event)*

*Key Type (Gpickup)*

*Account ID (the account this feature will be applied to)*

*Label (key label displayed on the LCD screen)*

*Value (the group pickup feature code)*

**Usage:** Press the DSS key on your phone when a phone number in the group receives an incoming call. The call is answered on your phone.

## DTMF

You can use this key feature to send the specification of arbitrary key sequences via DTMF.

**Dependencies:** *Type (Key Event)*

*Key Type (DTMF)*

*Label (key label displayed on the LCD screen)*

*Value (DTMF sequence)*

## Note

DTMF sequence can only contain "0-9", "\*", "#" and "A-D".

**Usage:** Press the DSS key during an active call to send the key sequence specified in the **Value** field.

## Prefix

You can use this key feature to add a specified prefix number before the dialed number.

**Dependencies:** *Type (Key Event)*

*Key Type (Prefix)*

*Label (key label displayed on the LCD screen)*

*Value (the prefix number)*

**Usage:** Press the DSS key when the phone is idle, the phone will then enter the pre-dialing screen and display the prefix number that you specified in the **Value** field. You can enter the remaining digits and then dial out.

## Local Group

You can use this key feature to quickly access a contact group in the local directory. For more information, refer to [Local Directory](#) on page 36.

**Dependencies:** *Type (Key Event)*

*Key Type (Local Group)*

*Local Group (the contact group name you want to access)*

*Label (key label displayed on the LCD screen)*

**Usage:** Press the DSS key to access the contact group specified in the **Local Group** field.

### XML Group

You can use this key feature to quickly access a remote group in your remote phone book. You should configure remote phone book in advance. For more information, refer to [Remote Phone Book](#) on page 51.

**Dependencies:** *Type (Key Event)*

*Key Type (XML Group)*

*XML Group (the remote group name you want to access if remote phone book is configured)*

*Label (key label displayed on the LCD screen)*

**Usage:** Press the DSS key to access the remote group specified in the **XML Group** field.

### XML Browser

You can use this key feature to quickly access a XML browser. The XML browser allows you to create custom services which meet your functional requirements on the server. You can customize practical applications, such as weather report, stock information, Google search, etc.

**Dependencies:** *Type (Key Event)*

*Key Type (XML Browser)*

*Label (key label displayed on the LCD screen)*

*Value (the access URL for XML browser)*

**Usage:** Press the DSS key to access the XML browser specified in the **Value** field.

### LDAP

You can use this key feature to quickly access a LDAP search screen.

**Dependencies:** *Type (Key Event)*

*Key Type (LDAP)*

*Label (key label displayed on the LCD screen)*

**Usage:**

1. Press the DSS key to access the LDAP search screen.
2. Enter a few continuous characters of the contact name or continuous numbers of the contact number using the keypad.

The contacts whose name or phone number matches the characters entered will appear on the LCD screen.

## Conference

You can use this key feature to set up a conference call. For more information, refer to [Conference](#) on page 113.

**Dependencies:** *Type (Key Event)*

*Key Type (Conference)*

*Label (key label displayed on the LCD screen)*

*Value (the number you want to add to the conference)*

**Usage:** Press the DSS key during an active call to set up a conference with the number specified in the **Value** field.

### Note

If the **Value** field is left blank, the DSS key performs the same as the **Conference** soft key during a call.

## Forward

You can use this key feature to forward an incoming call to someone else. For more information, refer to [Call Forward](#) on page 103.

**Dependencies:** *Type (Key Event)*

*Key Type (Forward)*

*Label (key label displayed on the LCD screen)*

*Value (the number you want to forward to)*

**Usage:** Press the DSS key to forward an incoming call to the number specified in the **Value** field.

### Note

If the **Value** field is left blank, the DSS key performs the same as the **Forward** soft key when receiving an incoming call.

## Transfer

When there is an active call on the phone, you can use this key feature to handle the call differently depending on the transfer mode assigned to the DSS key.

**Dependencies:** *Type (Key Event)*

*Key Type (Transfer)*

*Label (key label displayed on the LCD screen)*

*Value (the number you want to transfer to)*

**Usage:**

- When the transfer mode on DSS key is **Blind Transfer**, press the DSS key to complete the blind transfer to the number specified in the **Value** field.
- When the transfer mode on DSS key is **Attended Transfer**, press the DSS key to dial out the number specified in the **Value** field, and then perform the attended or

semi-attended transfer.

- When the transfer mode on DSS key is **New Call**, press the DSS key to place a new call to the number specified in the **Value** field.

#### Note

Transfer mode via DSS key is configurable via web user interface at the path **Features->Transfer->Transfer Mode Via Dsskey**.

If the **Value** field is left blank, the DSS key performs the same as the **TRANSFER** key or the **Transfer** soft key during a call. For more information, refer to [Call Transfer](#) on page 110.

#### Hold

You can use this key feature to place an active call on hold or retrieve a held call.

**Dependencies:** *Type (Key Event)*

*Key Type (Hold)*

*Label (key label displayed on the LCD screen)*

**Usage:**

1. Press the DSS key during an active call to place the call on hold.
2. Press the DSS key again to retrieve the held call.

#### DND

You can use this key feature to activate or deactivate DND. You can also use this key feature to access the custom DND screen. For more information, refer to [Do Not Disturb \(DND\)](#) on page 99.

**Dependencies:** *Type (Key Event)*

*Key Type (DND)*

*Label (key label displayed on the LCD screen)*

**Usage:**

When DND is in phone mode:

1. Press the DSS key to activate DND.
2. Press the DSS key again to deactivate DND.

When DND is in custom mode:

1. Press the DSS key to access the custom DND screen. You can activate or deactivate DND for one or all accounts.

#### Note

When DND is activated, the DND key LED will illuminate solid green, and the incoming calls will be rejected automatically.

#### SMS

You can use this key feature to quickly access text message. For more information, refer to [Short Message Service \(SMS\)](#) on page 144.

**Dependencies:** *Type (Key Event)*

*Key Type (SMS)*

*Label (key label displayed on the LCD screen)*

**Usage:** Press the DSS key when the phone is idle to access text message.

### **Group Listening**

You can use this key feature to activate the Speakerphone and Handset/Headset mode at the same time. It is suitable for the group conversations which have more than one person present at one end. You are able to speak and listen through the handset/headset, while the others nearby can only listen through the speaker.

**Dependencies:** *Type (Key Event)*

*Key Type (Group Listening)*

*Label (key label displayed on the LCD screen)*

**Usage:**

1. During a call, press the DSS key to activate the group listening mode.  
You can then speak and listen through the handset/headset, while other people at your side can only listen through the speaker at the same time.
2. Press the DSS key again to deactivate the group listening mode.

### **Zero Touch**

You can use this key feature to quickly configure auto provision and network parameters.

**Dependencies:** *Type (Key Event)*

*Key Type (Zero Touch)*

*Label (key label displayed on the LCD screen)*

**Usage:**

1. Press the DSS key to access the zero touch screen.
2. Press the **OK** soft key within a few seconds.
3. Configure the network parameters in the corresponding fields.
4. Press the **Next** soft key.
5. Configure the auto provision parameters in the corresponding fields.
6. Press the **OK** soft key.

The phone will reboot to update configurations.

### **URL**

You can use this key feature to trigger the phone to send an HTTP GET request containing a specific URL.

**Dependencies:** *Type (URL)*

*Label (key label displayed on the LCD screen)*

*URL (the URL contained in the HTTP GET request)*



**Usage:** Press the DSS key to trigger the phone to send an HTTP GET request containing the URL specified in the **URL** field.

### Phone Lock

You can use this key feature to immediately lock the phone of your phone instead of long pressing . For more information, refer to [Phone Lock](#) on page 28.

**Dependencies:** *Type (Key Event)*

*Key Type (Phone Lock)*

*Label (key label displayed on the LCD screen)*

**Usage:** Press the DSS key to immediately lock your phone instead of long pressing .

### Directory

You can use this key feature to easily access frequently used lists. For more information, refer to [Directory](#) on page 35.

**Dependencies:** *Type (Key Event)*

*Key Type (Directory)*

*Label (key label displayed on the LCD screen)*

**Usage:** Press the DSS key to immediately access to frequently used lists.

### Note

The DSS key performs the same function as the **Directory** soft key when the phone is idle.

## Programmable Keys

You can customize the soft keys, navigation keys and function keys.

**To customize programmable keys via web user interface:**

1. Click on **DSSKey->Programmable Key**.

2. Customize specific features for these keys.

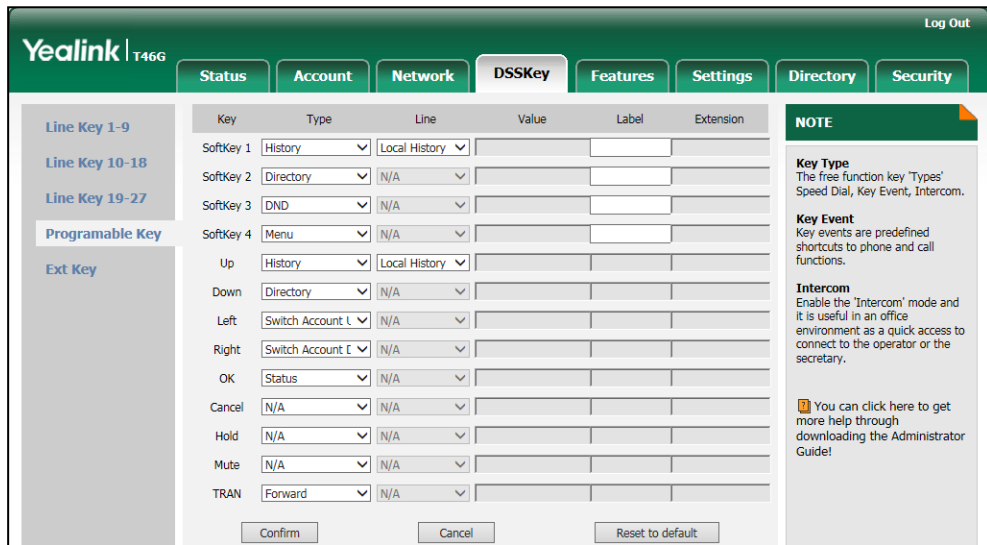

3. Click **Confirm** to accept the change.

You can click **Reset to default** to reset custom settings to defaults.

Then you can press the keys on the phone to perform the features you configured.

For example:

**Switch Account Up**

You can press this key to switch default account.

**Dependencies: Type (Switch Account Up)**

**Usage:** Press the programmable key to scroll up the account list to select the desired default account.

**Switch Account Down**

You can press this key to switch default account.

**Dependencies: Type (Switch Account Down)**

**Usage:** Press the programmable key to scroll down the account list to select the desired default account.

**Note** Programmable keys are configurable via web user interface only.

**Ext Keys**

You can customize features to Ext keys.

**To customize Ext keys via web user interface:**

1. Click on **DSSKey->Ext Key**.

2. Customize specific features for these keys.

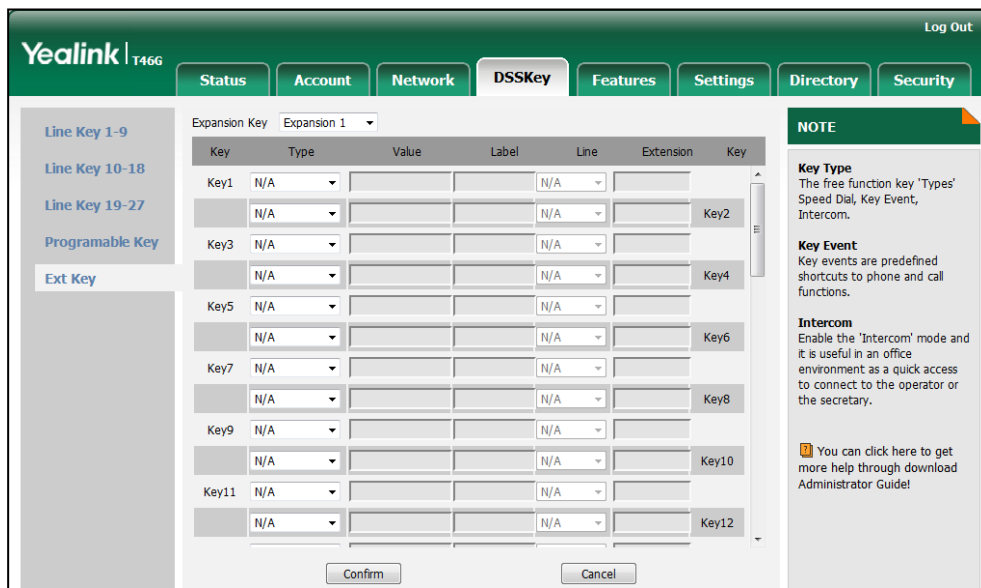

3. Click **Confirm** to accept the change.  
For more information, refer to EXP40 User Guide.

**Note** Ext keys are configurable via web user interface only.

## Account Management

You can register one or multiple accounts on the SIP-T46G IP phone. You can also configure each line key to associate with an account or configure multiple line keys to associate with an account.

### Account Registration

To register an account via phone user interface:

1. Press **Menu->Advanced** (default password: admin) ->**Accounts**.
2. Select the desired account and then press the **Enter** soft key.
3. Select **Enabled** from the **Account Status** field.
4. Enter the desired values in **Label**, **Display Name**, **Register Name**, **User Name**, **Password** and **SIP Server1/2** fields respectively. Contact your system administrator for more information.
5. Press the **Save** soft key to accept the change or the **Back** soft key to cancel.

You can repeat steps 2 to 5 to register more accounts.

The following figures demonstrate single or multiple accounts registered on the phone:

**Single account:**



**Multiple accounts:**



**To disable an account via phone user interface:**

1. Press **Menu**->**Advanced** (default password: admin) ->**Accounts**.
2. Select the desired account and then press the **Enter** soft key.
3. Select **Disabled** from the **Account Status** field.
4. Press the **Save** soft key to accept the change or the **Back** soft key to cancel.

Registering an account is configurable via web user interface at the path **Account**->**Register**.

**Note**

Press ◀ or ▶ to set the default account. It has priority when placing a call. The phone's default account cannot be changed after reboot.

## Multiple Line Keys per Account

You can configure multiple line keys to associate with an account. This enhances call visualization and simplifies call handling.

Key	Type	Value	Label	Line	Extension
Line Key1	Line	Default	1006	Line 1	
Line Key2	Line	Default	1006	Line 1	
Line Key3	Line	Default	3607	Line 2	
Line Key4	Line	Default	3607	Line 2	
Line Key5	Line	Default		Line 5	
Line Key6	Line	Default		Line 6	
Line Key7	Line	Default		Line 7	
Line Key8	Line	Default		Line 8	
Line Key9	Line	Default		Line 9	

If this is the case, the LCD screen will resemble the following figure:



Incoming calls to this account will be distributed evenly among the available line keys. Outgoing calls will be distributed similarly.

Your phone can be configured to have a combination of accounts with a single line key and accounts with multiple line keys.

## Dial Plan

Dial plan is a string of characters that governs the way your SIP-T46G IP phone processes the inputs received from your phone keypad. The SIP-T46G IP phone supports the following dial plan features:

- [Replace Rule](#)
- [Dial-now](#)
- [Area Code](#)
- [Block Out](#)

Basic expression syntaxes you need to know:

Syntax	Description
.	The dot "." can be used as a placeholder or multiple placeholders for any character. Example: "12." would match "123", "1234", "12345", "12abc", etc.
x	An "x" can be used as a placeholder for any character. Example: "12x" would match "121", "122", "123", "12a", etc.
[]	The square brackets "[]" can be used as a placeholder for a single character which matches any of a set of characters. Example: "91[5-7]1234" would match "9151234", "9161234", "9171234".
()	The parentheses "( )" can be used to group together patterns, for instance, to logically combine two or more patterns. Example: "([1-9])([2-7])3" would match "923", "153", "773", etc.
\$	The "\$" should be followed by the sequence number of a parenthesis. The "\$" plus the sequence number means the whole character or characters placed in the parenthesis. The number directs to the right parenthesis when there are more than one. Example: A replace rule configuration, Prefix: "001(xxx)45(xx)", Replace: "9001\$145\$2". When you dial out "0012354599" on your phone, the IP phone will replace the number with "90012354599". "\$1" means 3 digits in the first parenthesis, that is, "235". "\$2" means 2 digits in the second parenthesis, that is, "99".

## Replace Rule

You can configure one or more replace rules (up to 100) to remove the specified string and replace it with another string. You can configure a pattern with wildcards (refer to the expression syntax in the table above), so that any string that matches the pattern will be replaced. This feature is convenient for you to dial out a long number. For example, a replace rule is configured as "Prefix: 1" and "Replace: 1234", when you try to dial out the number "1234", you just need to enter "1" on the phone and then press the Send soft key.

**To add a replace rule via web user interface:**

1. Click on **Settings->Dial Plan->Replace Rule**.
2. Enter the string (e.g., 1) in the **Prefix** field.
3. Enter the string (e.g., 1234) in the **Replace** field.

- Enter the desired line ID in the **Account** field or leave it blank.

Index	Prefix	Replace	Account	
1	1	1234		<input type="checkbox"/>
2				<input type="checkbox"/>
3				<input type="checkbox"/>
4				<input type="checkbox"/>
5				<input type="checkbox"/>
6				<input type="checkbox"/>
7				<input type="checkbox"/>
8				<input type="checkbox"/>
9				<input type="checkbox"/>
10				<input type="checkbox"/>

Prefix: 1    Replace: 1234    Account:

Add    Edit    Del

**NOTE**  
**Digit 0-9 \***  
 Identifies a specific digit (do not use # if it is defined as send key).  
**[digit-digit]**  
 Identifies any digit dialed that is included in the range.  
**[digit-digit,digit]**  
 Specifies a range as a comma separated list.  
**x**  
 Matches any single digit/character which is dialed.  
**.**  
 Matches an arbitrary number of digits.  
 You can click here to get more help through downloading the Administrator Guide!

- Click **Add** to add the replace rule.

When you enter the number "1" using the keypad and then press the **Send** soft key, the phone will dial out "1234" instead.

#### Note

The valid values for the **Account** field can be one or more digits among 1-16. Every two digits must be separated by a comma. For example, when you enter the value "1, 2" in the **Account** field, this replace rule will apply to account1 and account2.

If you leave the **Account** field blank or enter 0, the replace rule will apply to all accounts.

#### To edit a replace rule via web user interface:

- Click on **Settings->Dial Plan->Replace Rule**.
- Select the desired replace rule by checking the checkbox.
- Edit the values in the **Prefix** and **Replace** fields.
- Enter the desired line ID in the **Account** field or leave it blank.
- Click **Edit** to accept the change.

#### To delete one or more replace rules via web user interface:

- Click on **Settings->Dial Plan->Replace Rule**.
- Select the one or more replace rules by checking the checkbox(es).
- Click **Del** to delete the replace rule(s).

#### Note

Replace rule is configurable via web user interface only.

## Dial-now

You can configure one or more dial-now rules (up to 100) on your phone. When the

dialed number matches the dial-now string, the number will be dialed out automatically. For example, a dial-now rule is configured as "2xx", any entered three-digit string beginning with 2 will then be dialed out automatically on the phone.

**To add a dial-now rule via web user interface:**

1. Click on **Settings->Dial Plan->Dial-now**.
2. Enter the desired value (e.g., 2xx) in the **Rule** field.
3. Enter the desired line ID in the **Account** field or leave it blank.

For more information on the valid values for the **Account** field, refer to [Replace Rule](#) on page 78.

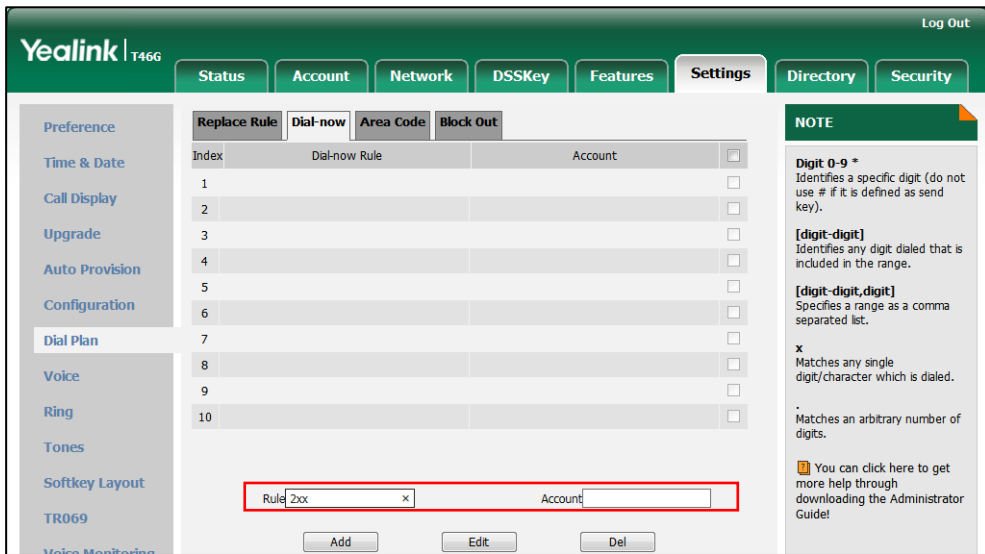

4. Click **Add** to add the dial-now rule.

When you enter the number "234" using the keypad, the phone will dial out "234" automatically without the pressing of any key.

**Note** You can also edit or delete the dial-now rule, refer to [Replace Rule](#) on page 78 for more information.

Dial-now rule is configurable via web user interface only.

**Delay Time for Dial-Now Rule**

You can configure the delay time for dial-now rules. That is, you can configure your phone to automatically dial out the phone number which matches a dial-now rule, after the designated delay time.

**To configure the delay time for dial-now rule via web user interface:**

1. Click on **Features->General Information**.



- Enter the time between 1 and 14 (seconds) in the **Time-Out for Dial-Now Rule** field.

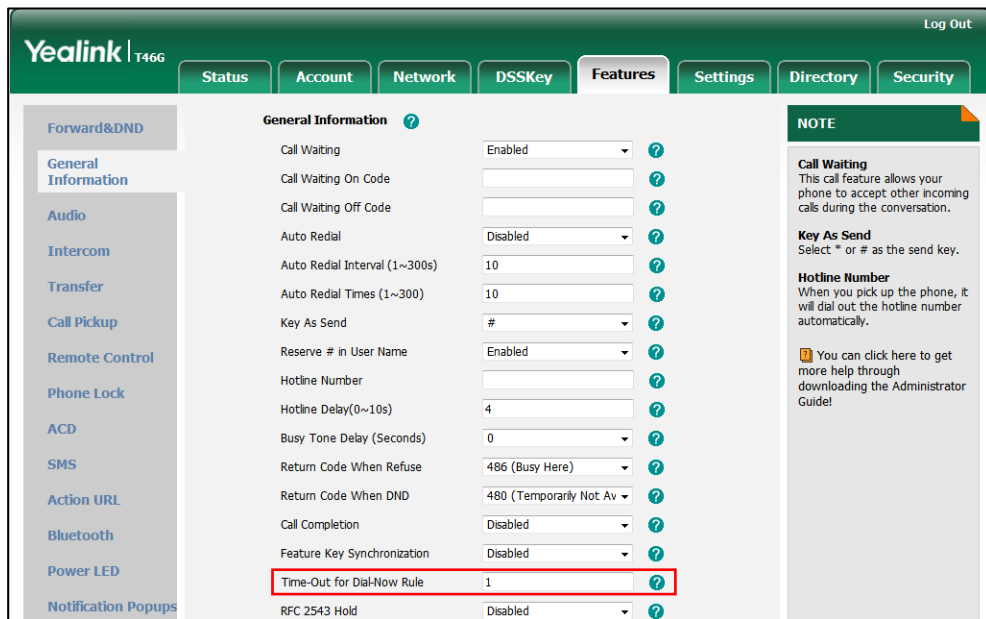

- Click **Confirm** to accept the change.

**Note** Delay time for dial-now rule is configurable via web user interface only.

## Area Code

Area codes are also known as Numbering Plan Areas (NPAs). They usually indicate geographical areas in a country. This feature is necessary when dialing a phone number outside the code area. For example, an area code is configured as "Code: 0592, Min Length: 1, Max Length: 15". When you dial out the number "56789" (the length of the number is between 1 and 15), the phone will add the area code and dial out the number "059256789". You can only configure one area code rule on your phone.

**To configure the area code and lengths via web user interface:**

- Click on **Settings->Dial Plan->Area Code**.
- Enter the desired values in the **Code**, **Min Length (1-15)** and **Max Length (1-15)** fields.
- Enter the desired line ID in the **Account** field or leave it blank.

For more information on the valid values for the **Account** field, refer to [Replace Rule](#) on page 78.

The screenshot shows the 'Block Out' configuration page in the Yealink T46G web interface. The page has a green header with 'Yealink | T46G' and 'Log Out'. Below the header are tabs for 'Status', 'Account', 'Network', 'DSSKey', 'Features', 'Settings', 'Directory', and 'Security'. The 'Settings' tab is active, and the 'Block Out' sub-tab is selected. The form contains fields for 'Code' (0592), 'Min Length (1-15)' (1), 'Max Length (1-15)' (15), and 'Account' (1). There are 'Confirm' and 'Cancel' buttons. A 'NOTE' box on the right explains symbols like [Digit 0-9], [digit-digit], [digit-digit,digit], x, and -.

4. Click **Confirm** to accept the change.

#### Note

The default values of minimum and maximum length are 1 and 15 respectively.  
Area code is configurable via web user interface only.

## Block Out

You can block some specific numbers (up to 10) from being dialed on your phone. When you dial a block out number on your phone, the dialing will fail and the LCD screen will prompt "Forbidden Number".

**To add a block out number via web user interface:**

1. Click on **Settings->Dial Plan->Block Out**.
2. Enter the desired value in the **BlockOut Number** field.
3. Enter the desired line ID in the **Account** field or leave it blank.

For more information on the valid value of the **Account** field, refer to [Replace Rule](#) on page 78.

4. Click **Confirm** to add the block out number.

**Note** Block out number is configurable via web user interface only.

## Emergency Number

Public telephone networks in countries around the world have a single emergency telephone number (emergency services number), that allows a caller to contact local emergency services for assistance when necessary. The emergency telephone number may differ from country to country. It is typically a three-digit number so that it can be easily remembered and dialed quickly. Some countries have a different emergency number for each of the different emergency services.

You can specify the emergency telephone numbers on the IP phone for contacting the emergency services in an emergency situation.

**Note** Contact your local phone service provider for available emergency numbers in your area.

**To specify emergency numbers via web user interface:**

1. Click on **Features->Phone Lock**.
2. Enter the emergency number in the **Emergency** field.

For multiple emergency numbers, enter a comma between every two numbers. The default emergency numbers are 112, 911 and 110.

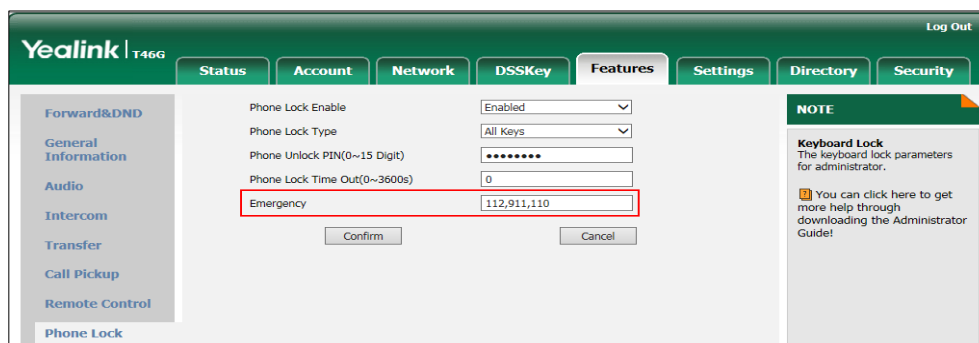

3. Click **Confirm** to accept the change.

**Note**

Emergency number is configurable via web user interface only.

## Live Dialpad

You can enable live dialpad on the SIP-T46G IP phone, which enables the IP phone to automatically dial out a phone number without the pressing of the send key. You can also configure a delay, where the phone will dial out the phone number automatically after the designated period of time.

**To enable the live dialpad via web user interface:**

1. Click on **Settings->Preference**.
2. Select **Enabled** from the pull-down list of **Live Dialpad**.
3. Enter the desired delay time in the **Inter Digit Time (1~14s)** field.

The default delay time is 4s.

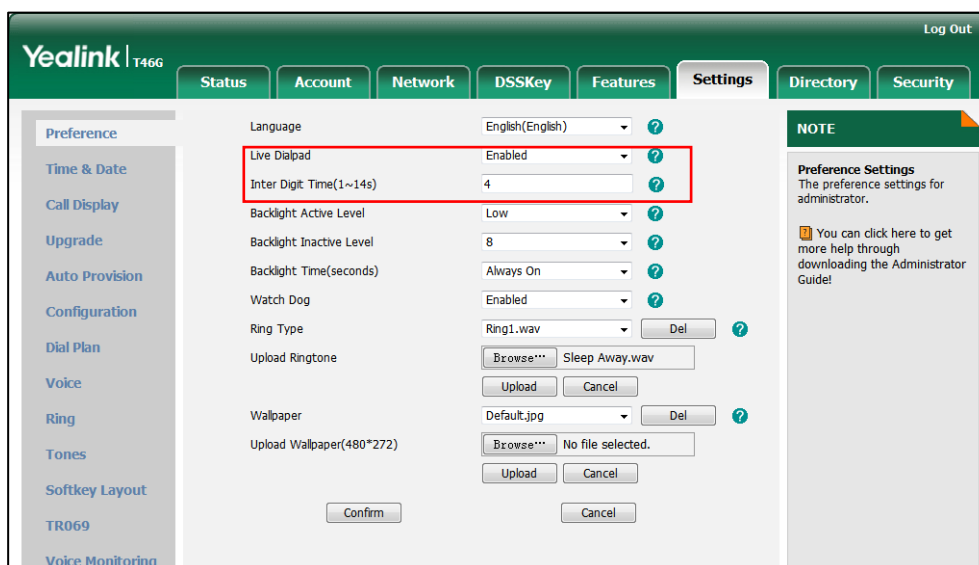

4. Click **Confirm** to accept the change.

**Note** Live dialpad is configurable via web user interface only.

## Hotline

You can dial a hotline number immediately upon lifting the handset, pressing the speakerphone key or the line key. You can also configure a delay, where the phone will dial out the hotline number automatically after the designated period of time.

**To configure the hotline number via phone user interface:**

1. Press **Menu->Features->Others->Hot Line**.
2. Enter the desired number in the **Number** field.
3. Enter the delay time in the **HotLine Delay** field.

The valid values range from 0 to 10(s).



Hot Line	
1. Number:	1008
2. HotLine Delay:	4

Back    123    Delete    Save

4. Press the **Save** soft key to accept the change or the **Back** soft key to cancel.

Hotline is configurable via web user interface at the path **Features->General Information**.



## Basic Call Features

---

The SIP-T46G IP phone is designed to be easily used like a regular phone on a public switched telephone network (PSTN). You can place calls, answer calls, transfer a call to someone else, or conduct a conference call.

This chapter provides basic operating instructions for the SIP-T46G IP phone. Topics include:

- [Placing Calls](#)
- [Answering Calls](#)
- [Ending Calls](#)
- [Redialing Numbers](#)
- [Recent Call In Dialing](#)
- [Auto Answer](#)
- [Auto Redial](#)
- [Call Completion](#)
- [Recall](#)
- [Call Mute](#)
- [Call Hold/Resume](#)
- [Do Not Disturb \(DND\)](#)
- [Call Forward](#)
- [Call Transfer](#)
- [Call Waiting](#)
- [Conference](#)
- [Call Park](#)
- [Call Pickup](#)
- [Anonymous Call](#)
- [Anonymous Call Rejection](#)

If you require additional information or assistance with your new phone, contact your system administrator.

## Placing Calls

You can place a call in one of three ways using your SIP-T46G IP phone:

- Using the handset

- Using the speakerphone
- Using the headset

You can also dial the number first, and then choose the way you want to speak to the other party.



You can also search and dial a contact from call history, local directory or remote phone book. For more information, refer to [Contact Management](#) on page 34 and [Call History Management](#) on page 53.

During a call, you can alternate between Speakerphone, Headset, and Handset modes by pressing the Speakerphone key, the HEADSET key, or by picking up the handset.

The call duration of the active call is visible on the LCD screen. In the figure below, the call to the number "1000" has lasted 40 seconds.



#### To place a call using the handset:

1. Pick up the handset.
2. Enter the desired number using the keypad.
3. Press  ,  , or the **Send** soft key.

The # key is configured as a send key by default. You can also set the \* key as the send key, or set neither. For more information, refer to the [Key as Send](#) on page 27.



#### Note

You can also dial using the SIP URI or IP address. To obtain the IP address of a phone, press the **OK** key when the phone is idle. The maximum length of SIP URI or IP address length is 32 characters. For example, SIP URI: 3606@sip.com, IP: 192.168.1.15.

Your phone may not support direct IP dialing. Contact your system administrator for more information.



#### To place a call using the hands-free speakerphone mode:

Do one of the following:

- With the handset on-hook, press  or the line key to obtain a dial tone.  
Enter the desired number using the keypad.  
Press  ,  or the **Send** soft key.









- With the handset on-hook, enter the desired number using the keypad.

Press  ,  ,  or the **Send** soft key.

#### To place a call using the headset:

Do one of the following:

- With the optional headset connected, press  to activate the headset mode.  
Press the line key to obtain a dial tone.  
Enter the desired number using the keypad.  
Press  ,  , or the **Send** soft key.
- With the optional headset connected, press  to activate the headset mode.  
Enter the desired number using the keypad.  
Press  ,  , or the **Send** soft key.





#### Note



To permanently use the headset mode, refer to [Headset Prior](#) on page 56.

The SIP-T46G IP phone can handle multiple calls at a time. However, only one active call (the call that has audio associated with it) can be in progress at any given time. The SIP-T46G IP phone can handle a maximum of 6 calls at one time.

#### To place multiple calls:

You can have more than one call on your SIP-T46G IP phone. To place a new call during an active call, do one of the following:

- Press the line key. The active call is placed on hold.  
Enter the desired number using the keypad.  
Press  ,  , or the **Send** soft key.
- Press  or the **Hold** soft key to place the original call on hold.  
Press the **New Call** soft key.  
Enter the desired number using the keypad.  
Press  ,  , or the **Send** soft key.

You can press  or  to switch between calls, and then press the **Resume** soft key to retrieve the desired call.

#### Note

If multiple accounts are registered on the phone, you can first press the desired line key in the idle screen or press the **Line** soft key in the dialing screen, and then you can use the selected account to place a call.

## Answering Calls

When you are not in another call, you can answer a call in one of three ways:

- Using the handset
- Using the speakerphone
- Using the headset

### Note

You can reject incoming calls by pressing the **X** key or the **Reject** soft key. You can also activate Do Not Disturb mode to reject the incoming calls without ringing on your phone. For more information, refer to [Do Not Disturb \(DND\)](#) on page 99.

You can forward incoming calls to someone else by pressing the **Forward** soft key. For more information, refer to [Call Forward](#) on page 103.

### Answering When Not in Another Call

Call duration and destination will always appear on the LCD screen for the active call.

#### To answer a call using the handset:

1. Pick up the handset.

#### To answer a call using the hands-free speakerphone mode:

Do one of the following:

- Press  .
- With the handset on-hook and the headset mode deactivated, press the **Answer** soft key.
- With the handset on-hook and the headset mode deactivated, press the line key (the line key LED flashes green).

#### To answer a call using the headset:

Do one of the following:

- Press  .
- With the headset mode activated, press the **Answer** soft key.
- With the headset mode activated, press the line key (the line key LED flashes green).

## Answering When in Another Call

If you have an active call, and an incoming call arrives on the phone, do one of the following:

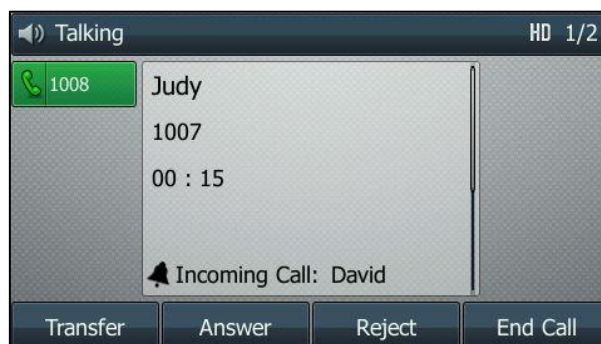

- Press the **Answer** soft key.  
The incoming call is answered and the original call is placed on hold.
- Press  to access the new call.



Press  or the **Answer** soft key.

The incoming call is answered and the original call is placed on hold.



## Ending Calls

**To end a call:**

Do one of the following:

- If you are using the handset, press the **End Call** soft key or hang up the handset.
- If you are using the headset, press the **End Call** soft key.
- If you are using the speakerphone, press  or the **End Call** soft key.

### Note





When a call is placed on hold, you cannot press  to end it. You should press the **Resume** soft key to resume the call, and then press  to end it.

## Redialing Numbers

To redial the last dialed number from your phone:

1. Press  twice.  
A call to your last dialed number is attempted.

To redial a previously dialed number from your phone:

1. Press  when the phone is idle.
2. Press  or  to select the desired entry from the placed calls list, and then press  or the **Send** soft key.

## Recent Call In Dialing

To view the placed calls list when the phone is in the pre-dialing interface, you should enable recent call in dialing in advance.

To enable recent call in dialing via web user interface:

1. Click on **Directory->Setting**.
2. Select **Enabled** from the pull-down list of **Recent Call In Dialing**.

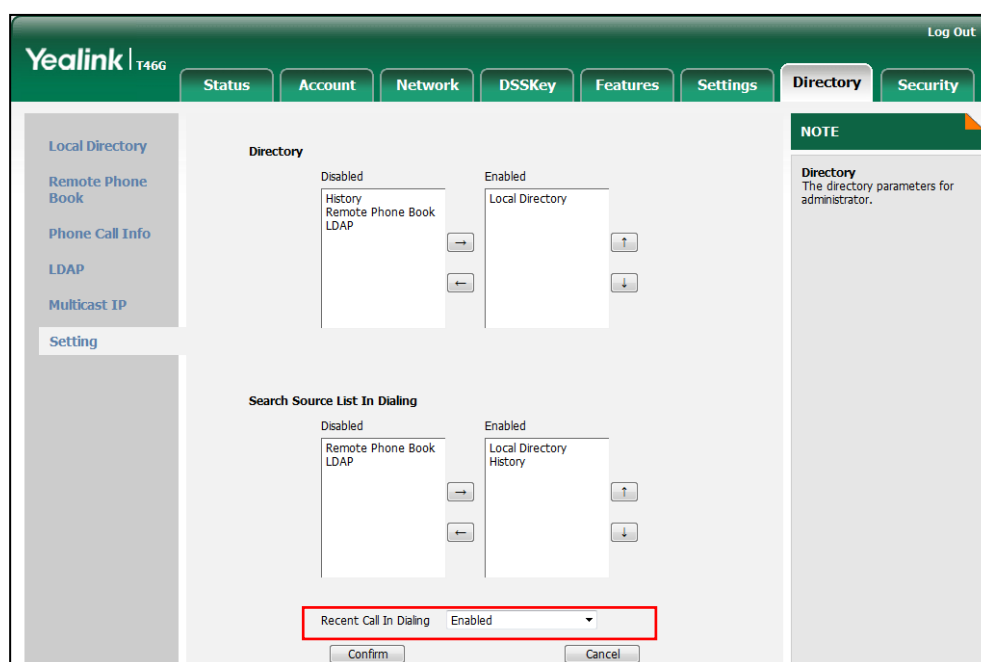

3. Click **Confirm** to accept the change.

### Note

Recent call in dialing is configurable via web user interface only.

To view placed calls list when the phone is in the pre-dialing interface:

1. Pick up the handset, press the speakerphone key or press the line key.  
The LCD screen displays the placed calls list.

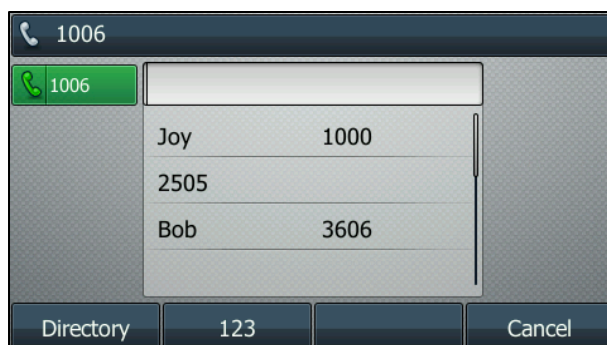

## Auto Answer

You can use auto answer to automatically answer an incoming call on a line. Auto answer is configurable on a per-line basis.

To configure auto answer via phone user interface:

1. Press **Menu->Features->Auto Answer**.
2. Select the desired line and then press the **Enter** soft key.
3. Press  $\leftarrow$  or  $\rightarrow$ , or the **Switch** soft key to select **Enabled** from the **Auto Answer** field.

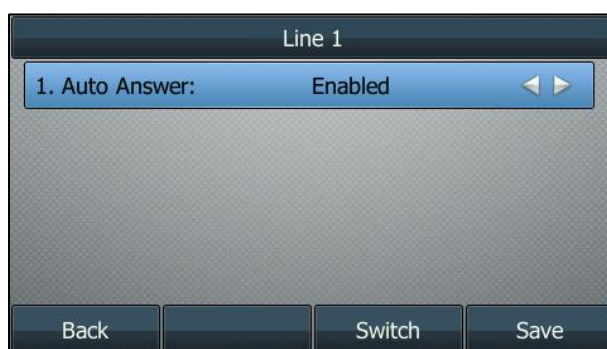

4. Press the **Save** soft key to accept the change or the **Back** soft key to cancel.

The **AA** icon appears on the LCD screen.



Auto answer is configurable via web user interface at the path **Account->Basic**.

### Note

Auto answer is only applicable when there is no other call in progress on the phone.

## Auto Redial

You can enable auto redial to automatically redial a phone number when the called party is busy. You can also configure the number of auto redial attempts and the time to wait between redial attempts.

**To configure auto redial via phone user interface:**

1. Press **Menu->Features->Others->Auto Redial**.
2. Press **◀** or **▶**, or the **Switch** soft key to select **Enabled** from the **Auto Redial** field.
3. Enter the desired time (in seconds) in the **Redial Interval** field.  
The default time interval is 10 seconds.
4. Enter the desired number of redial attempts in the **Redial Times** field.  
The default value is 10.

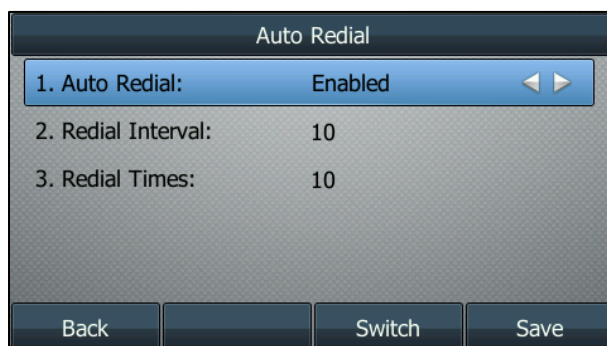

5. Press the **Save** soft key to accept the change or the **Back** soft key to cancel.

Auto redial is configurable via web user interface at the path **Features->General Information**.

**To use auto redial:**

When the called party is busy, the LCD screen prompts the following:

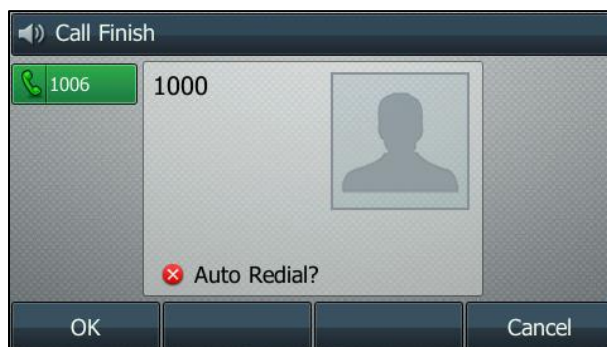

1. Press the **OK** soft key to activate auto redial. The following prompt will appear on the LCD screen of the phone:



2. Wait for the designated period of time or press the **OK** soft key to redial the phone number.



The phone will retry as many times as configured until the called party is idle.

## Call Completion

You can use call completion to notify the caller who failed to reach a desired party when the party becomes available to receive a call.

**To configure call completion via phone user interface:**

1. Press **Menu->Features->Others->Call Completion**.

2. Press  or , or the **Switch** soft key to select **Enabled** from the **Call Completion** field.

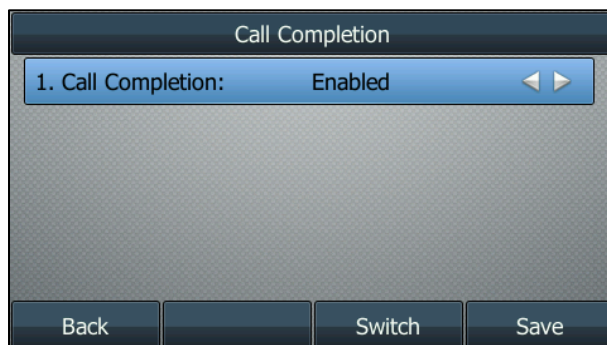

3. Press the **Save** soft key to accept the change or the **Back** soft key to cancel.

Call completion is configurable via web user interface at the path **Features->General Information**.

**To use call completion:**

When the called party is busy, the following prompt will appear on the LCD screen of the phone:

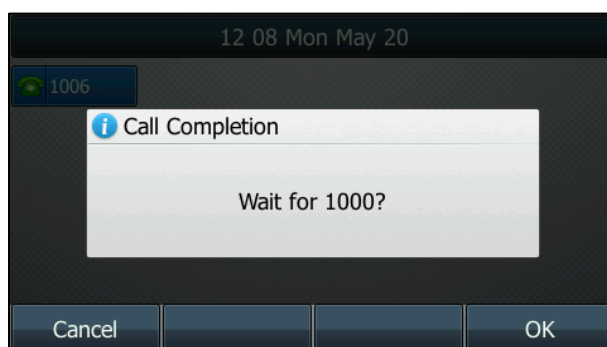

1. Press the **OK** soft key, the phone returns to the idle screen and call completion is activated.
2. When the called party becomes idle, the LCD screen prompts the following:

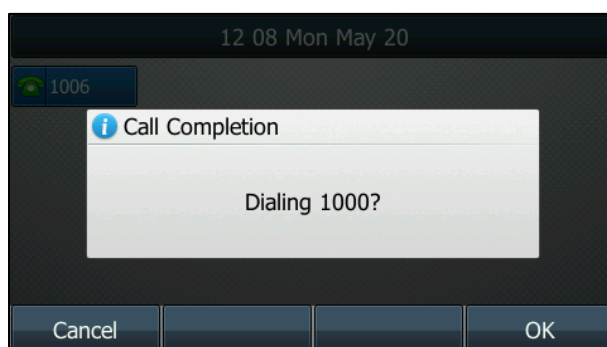



3. Press the **OK** soft key to redial the number.

**Note**

Call completion is not available on all servers. For more information, contact your system administrator.

## Recall

You can press a recall key to place a call back to the last incoming call.

**To configure a recall key via phone user interface:**

1. Press **Menu->Features->DSS Keys**.
2. Select a desired DSS key.
3. Press ◀ or ▶, or the **Switch** soft key to select **Key Event** from the **Type** field.
4. Press ◀ or ▶, or the **Switch** soft key to select **ReCall** from the **Key Type** field.
5. (Optional.) Enter a string that will appear on the LCD screen in the **Label** field.



6. Press the **Save** soft key to accept the change or the **Back** soft key to cancel.

Recall key is configurable via web user interface at the path **DSSKey->Line key**.

## Call Mute

You can mute the microphone of the active audio device during an active call so that the other party cannot hear you. Call mute applies to all modes (Handset, Headset and Speakerphone).

**To mute a call:**

1. Press  during an active call.

The LCD screen indicates that the call is now muted. The mute key LED illuminates solid red when the call is muted.

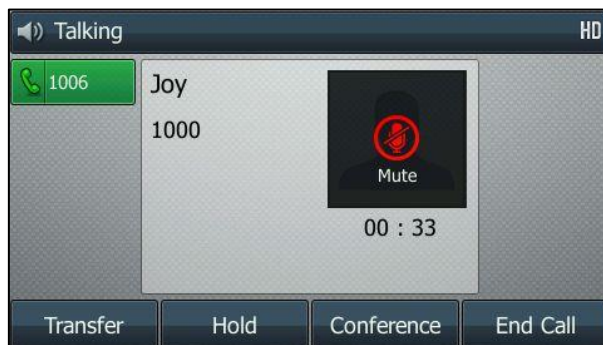
**To un-mute a call:**

1. Press  again to un-mute the call.

## Call Hold/Resume

You can place an active call on hold. Only one active call can be in progress at any time. Other calls can be made and received while placing the original call on hold. When you place a call on hold, your IP PBX may play music to the other party while waiting.

**To place a call on hold:**

1. Press  or the **Hold** soft key during a call.

The LCD screen indicates that the call is on hold.





The line key LED flashes green. The phone will beep softly every 30 seconds to remind you that you still have a call on hold.

**To resume a held call:**

1. Press  or the **Resume** soft key.

### Multiple Calls on Hold:

If multiple calls are placed on hold, do one of the following:

- Press  or  to switch between the calls, and then press the **Resume** soft key to retrieve the desired call.
- Press the corresponding line key to retrieve the call.

If more than two calls are on hold, a numbered prompt appears on the LCD screen, for example "2/4", indicating that this is the second call out of four calls.

## Do Not Disturb (DND)

You can use DND to reject incoming calls automatically on the phone. The prompt message "**n New Missed Call(s)**" ("n" indicates the number of missed calls) will appear on the LCD screen, and callers will receive a busy message. All calls you receive while DND is enabled are logged to your missed calls list.

### Note

The prompt message will display only if Missed Call Log for the line is enabled. Missed call log is configurable via web user interface at the path **Account->Basic**.

Do not disturb is local to the phone, and may be overridden by the server settings. For more information, contact your system administrator.

You can enable/disable DND for the phone system, or you can customize DND for each or all accounts. Two DND modes:

- **Phone** (default): DND is effective for the phone system.
- **Custom**: DND can be configured for each or all accounts.

You can receive incoming calls from authorized numbers when DND is enabled.

### To configure the DND mode via web user interface:

1. Click on **Features->Forward & DND**.

- In the **DND** block, mark the desired radio box in the **Mode** field.

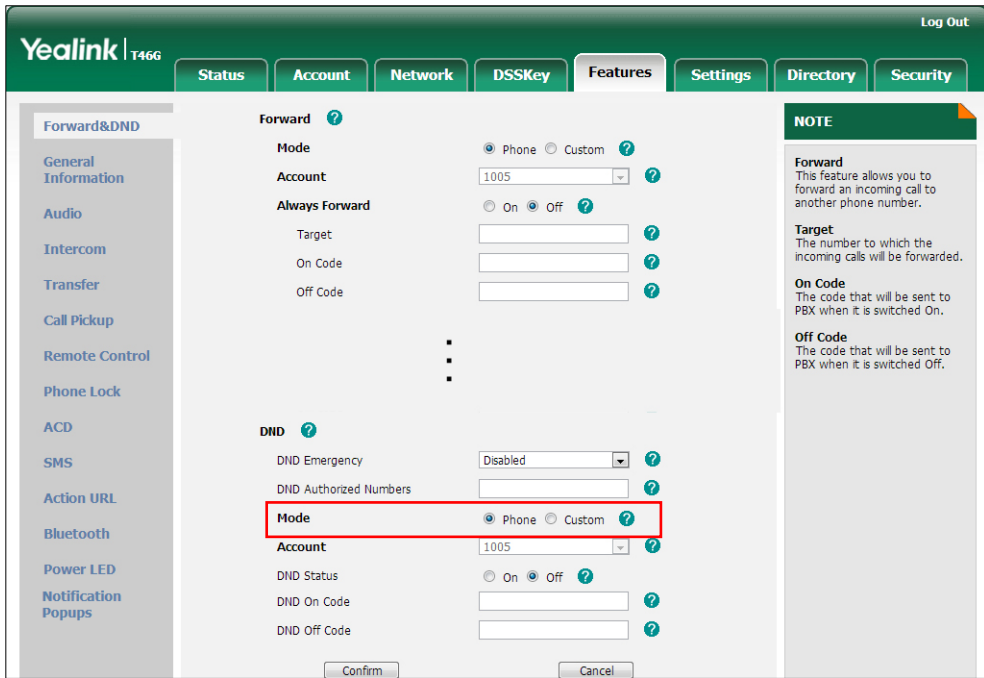

- Click **Confirm** to accept the change.

**Note**

DND mode is configurable via web user interface only.

**To activate DND in phone mode:**

- Press the **DND** soft key when the phone is idle.

The  icon on the idle screen indicates that DND is enabled.

Incoming calls will be rejected automatically and "n New Missed Call(s)" ("n" indicates the number of missed calls) will appear on the LCD screen.

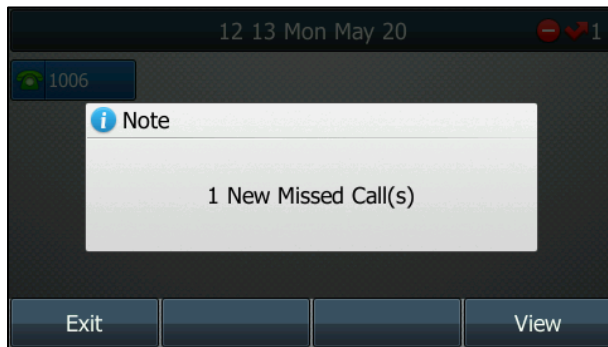

**Note**

When DND and busy forward are enabled in phone mode, calls will be sent to the configured destination number. For more information on busy forward, refer to [Call Forward](#) on page 103.

**To activate DND in custom mode for a specific account:**

1. Press the **DND** soft key when the phone is idle.

The LCD screen displays a list of accounts on the phone.

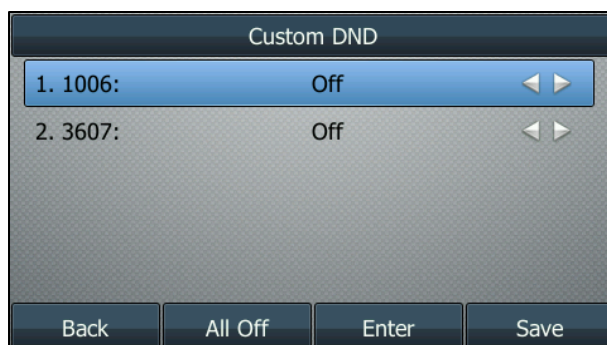

2. Press or to select the desired account and then press the Enter soft key.
3. Press or soft key to select **On** to activate DND.
4. Press the **Save** soft key to accept the change.

If you activate DND for the default account, the associated line icon will change to , and the icon will appear on the status bar.

If you activate DND for the non-default account, only the associated line icon will change to .

Incoming calls on the specific line will be rejected automatically, and the LCD screen will prompt "**n New Missed Call(s)**" ("n" indicates the number of missed calls).

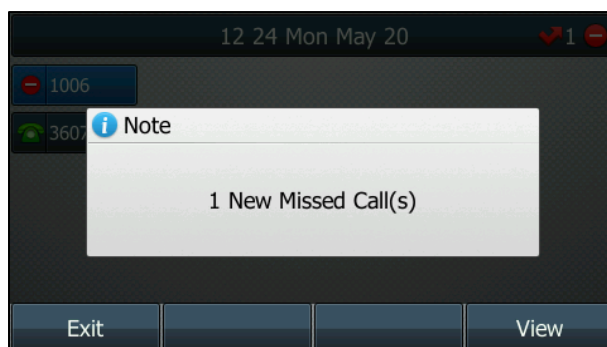

**Note**

When DND and busy forward are enabled for a specific account, calls from the specific account will be sent to the configured destination number. For more information on busy forward, refer to [Call Forward](#) on page 103.

**To activate DND in custom mode for all accounts:**

1. Press the **DND** soft key when the phone is idle.

The LCD screen displays a list of accounts registered on the phone.

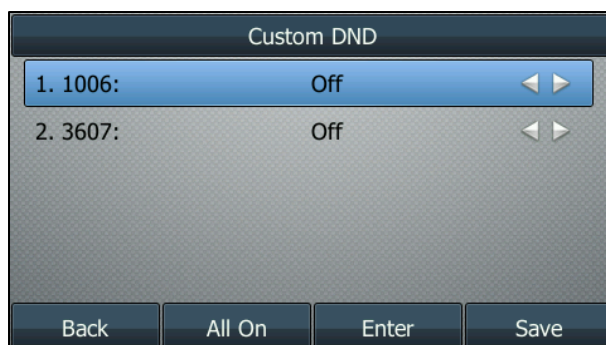

2. Press the **All On** soft key to activate DND for all accounts.
3. Press the **Save** soft key to accept the change.

The  icon appears on the idle screen, and all line icons change to .

Incoming calls will be rejected automatically, and the LCD screen will prompt "**n New Missed Call(s)**" ("n" indicates the number of missed calls).

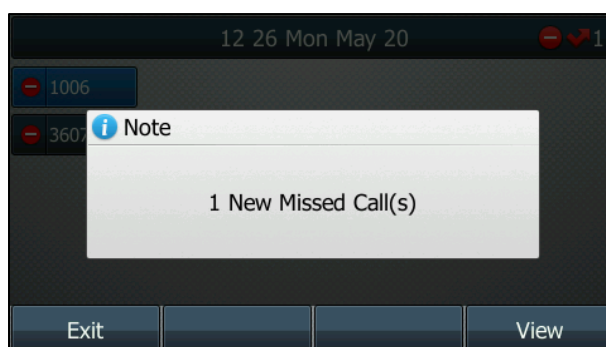

**To configure the DND authorized numbers via web user interface:**

1. Click on **Features->Forward & DND**.
2. Select **Enabled** from the pull-down list of **DND Emergency**.

3. Enter the numbers in the **DND Authorized Numbers** field.

For multiple numbers, enter a comma between every two numbers.

The screenshot shows the Yealink T46G web interface. The 'Features' tab is selected, and the 'Forward & DND' section is active. The 'Forward' section is partially visible, showing 'Mode' set to 'Phone', 'Account' set to '1005', and 'Always Forward' set to 'Off'. The 'DND' section is highlighted with a red box, showing 'DND Emergency' set to 'Enabled' and 'DND Authorized Numbers' set to '123, 456'. The 'DND Status' is set to 'On'. The 'DND On Code' and 'DND Off Code' fields are empty. The 'Confirm' and 'Cancel' buttons are at the bottom.

4. Click **Confirm** to accept the change.

When DND is enabled on the phone, the phone can still receive incoming calls from the numbers specified in the **DND Authorized Numbers** field.

**Note**

DND authorized number is configurable via web user interface only.

When the phone receives a voice mail, the voice mail prompt window will pop up by default, if you want to disable the feature, contact your system administrator for more information.

## Call Forward

You can configure your phone to forward incoming calls to another party through static forwarding. You can also forward calls while your phone is ringing; refer to the dynamic forwarding.

### Static Forwarding

Three types of static forwarding:

- **Always Forward:** Incoming calls are immediately forwarded.
- **Busy Forward:** Incoming calls are immediately forwarded if the phone is busy.
- **No Answer Forward:** Incoming calls are forwarded if not answered after a period of time.

You can enable/disable call forward for the phone system, or you can customize call forward for each or all accounts. Two call forward modes:

- **Phone** (default): Call forward is effective for the phone system.
- **Custom**: Call forward can be configured for each or all accounts.

To configure the call forward mode via web user interface:

1. Click on **Features->Forward & DND**.
2. In the **Forward** block, mark the desired radio box in the **Mode** field.

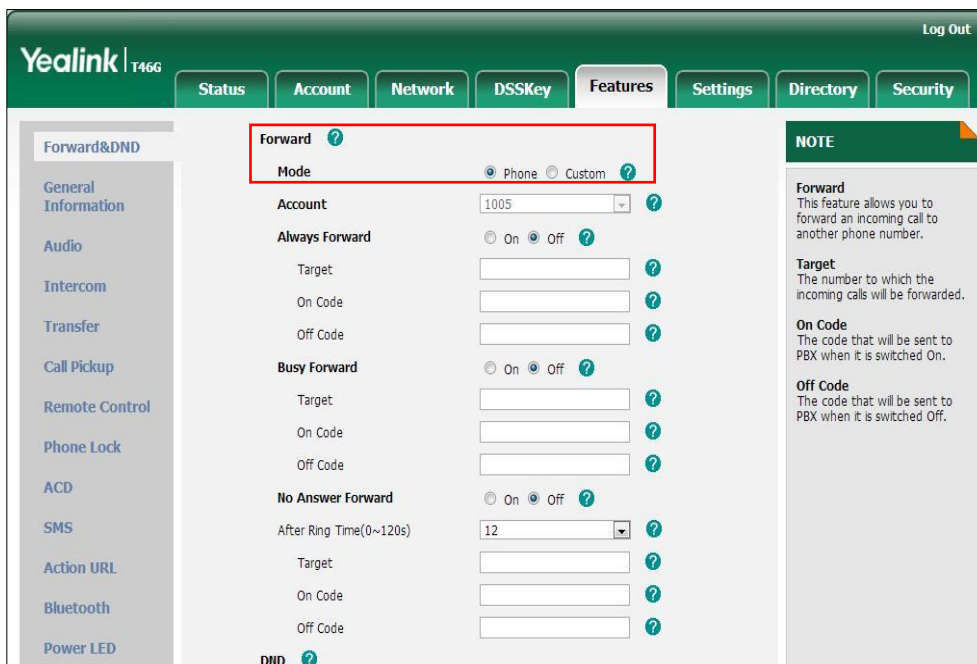

3. Click **Confirm** to accept the change.

**Note** Call forward mode is configurable via web user interface only.

To enable call forward in phone mode:

1. Press **Menu->Features->Call Forward**.
2. Press **▲** or **▼** to select the desired forwarding type, and then press the **Enter** soft key.
3. Depending on your selection:
  - a.) If you select **Always Forward**:
    - 1) Press **◀** or **▶**, or the **Switch** soft key to select **Enabled** from the **Always Forward** field.
    - 2) Enter the destination number you want to forward all incoming calls to in the **Forward to** field.
    - 3) (Optional.) Enter the always forward on code or off code respectively in the



**On Code or Off Code** field.

Busy Forward	
1. Busy Forward:	Enabled
2. Forward to:	1234
3. On Code:	*73
4. Off Code:	*74

Back    123    Delete    Save

b.) If you select **Busy Forward**:

- 1) Press ◀ or ▶, or the **Switch** soft key to select **Enabled** from the **Busy Forward** field.
- 2) Enter the destination number you want to forward incoming calls to when the phone is busy in the **Forward to** field.
- 3) (Optional.) Enter the busy forward on code or off code respectively in the **On Code** or **Off Code** field.

Busy Forward	
1. Busy Forward:	Enabled
2. Forward to:	1234
3. On Code:	*73
4. Off Code:	*74

Back    123    Delete    Save

c.) If you select **No Answer Forward**:

- 1) Press ◀ or ▶, or the **Switch** soft key to select **Enabled** from the **No Answer Forward** field.
- 2) Enter the destination number you want to forward unanswered incoming calls to in the **Forward to** field.
- 3) Press ◀ or ▶, or the **Switch** soft key to select the ring time to wait before forwarding from the **After Ring Time** field.





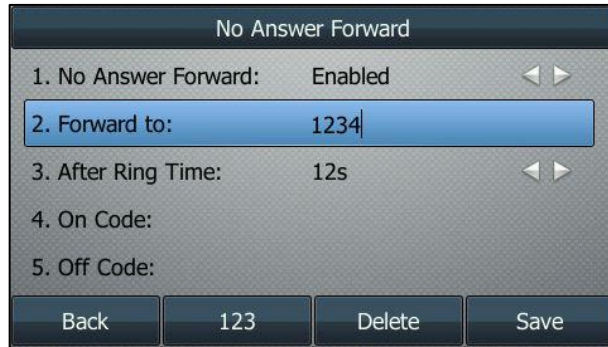

The default ring time is 12 seconds.

- 4) (Optional.) Enter the no answer forward on code or off code respectively in the **On Code** or **Off Code** field.





4. Press the **Save** soft key to accept the change or the **Back** soft key to cancel.  
The  icon on the idle screen indicates that the call forward is enabled.

**To enable call forward in custom mode:**

1. Press **Menu->Features->Call Forward**.
2. Press  or  to select the desired account, and then press the **Enter** soft key.
3. Press  or  to select the desired forwarding type, and then press the **Enter** soft key.
4. Depending on your selection:
  - a.) If you select **Always Forward**, you can enable it for a specific account.
    - 1) Press  or , or the **Switch** soft key to select **Enabled** from the **Always Forward** field.
    - 2) Enter the destination number you want to forward all incoming calls to in the **Forward to** field.
    - 3) (Optional.) Enter the always forward on code or off code respectively in the **On Code** or **Off Code** field.



You can also enable always forward for all accounts. After always forward was enabled for a specific account, do the following:

- 1) Press  or  to highlight the **Always Forward** field.
- 2) Press the **All Lines** soft key.

The LCD screen prompts “Copy to all lines?”.

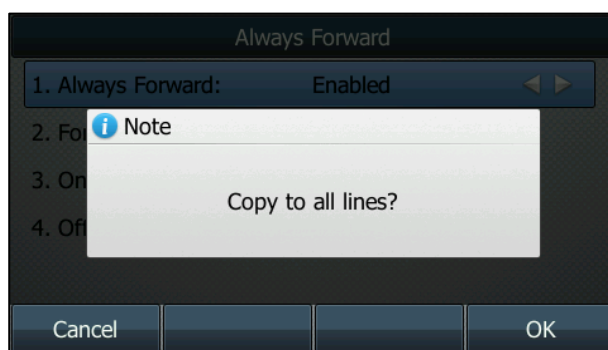

- 3) Press the **OK** soft key to accept the change or the **Cancel** soft key to cancel.
- b.) If you select **Busy Forward**, you can enable it for a specific account.
- 1) Press  $\leftarrow$  or  $\rightarrow$  , or the **Switch** soft key to select **Enabled** from the **Busy Forward** field.
  - 2) Enter the destination number you want to forward incoming calls to when the phone is busy in the **Forward to** field.
  - 3) (Optional.) Enter the busy forward on code or off code respectively in the **On Code** or **Off Code** field.



You can also enable busy forward for all accounts. After busy forward was enabled for a specific account, do the following:

- 1) Press  $\uparrow$  or  $\downarrow$  to highlight the **Busy Forward** field.

- 2) Press the **All Lines** soft key.  
The LCD screen prompts “Copy to all lines?”.

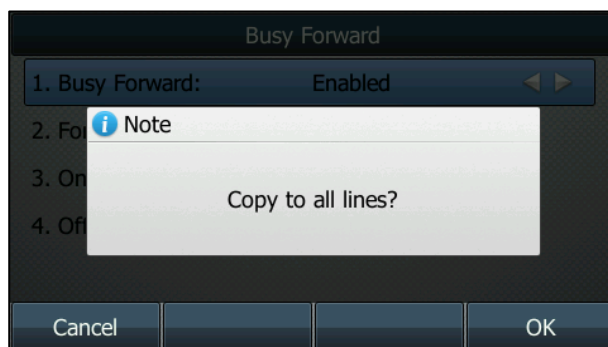

- 3) Press the **OK** soft key to accept the change or the **Cancel** soft key to cancel.
- c.) If you select **No Answer Forward**, you can enable it for a specific account.
- 1) Press  $\leftarrow$  or  $\rightarrow$ , or the **Switch** soft key to select **Enabled** from the **No Answer Forward** field.
  - 2) Enter the destination number you want to forward unanswered incoming calls to in the **Forward to** field.
  - 3) Press  $\leftarrow$  or  $\rightarrow$ , or the **Switch** soft key to select the ring time to wait before forwarding from the **After Ring Time** field.  
The default ring time is 12 seconds.
  - 4) (Optional.) Enter the no answer forward on code or off code respectively in the **On Code** or **Off Code** field.

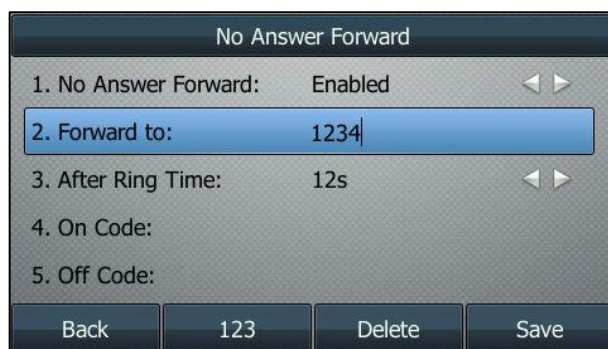

You can also enable no answer forward for all accounts. After no answer forward was enabled for a specific account, do the following:

- 1) Press  $\uparrow$  or  $\downarrow$  to highlight the **No Answer Forward** field.

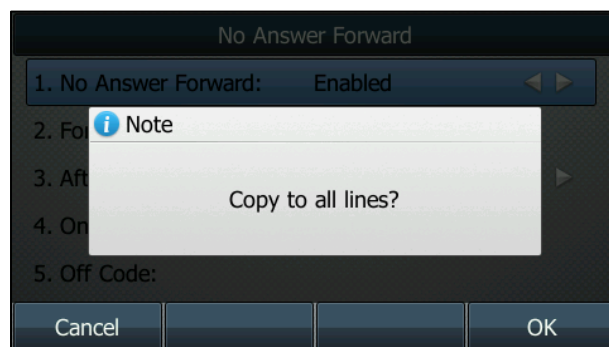

- 2) Press the **All Lines** soft key.

The LCD screen prompts “Copy to all lines?”.



- 3) Press the **OK** soft key to accept the change or the **Cancel** soft key to cancel.

5. Press the **Save** soft key to accept the change or the **Back** soft key to cancel.

If you activate call forward for the default account, the associated line icon will change to , and the  icon will appear on the status bar.

If you activate call forward for the non-default account, only the associated line icon will change to .

Call forward is configurable via web user interface at the path **Features->Forward & DND**.





#### Note

You can also enter the SIP URI or IP address in the **Forward to** field. For more information on using the SIP URI or IP address, refer to [Placing Calls](#) on page 87.

Call forward is local to the phone, and may be overridden by the server settings. Call forward on code or off code may be different between servers. For more information, contact your system administrator.



#### To disable call forward in phone mode:





Do one of the following:

- Press  when the phone is idle.
- Press **Menu->Features->Call Forward**.  
Press  or  to select the desired forwarding type, then press the **Enter** soft key.  
Press  or , or the **Switch** soft key to select **Disabled** to disable the call forward.

Press the **Save** soft key to accept the change.

#### To disable call forward in custom mode for a specific account:

1. Press **Menu->Features->Call Forward** or press  when the phone is idle.
2. Press  or  to select the desired account, then press the **Enter** soft key.

3. Press  or  to select the desired forwarding type, then press the **Enter** soft key.
4. Press  or , or the **Switch** soft key to select **Disabled** to disable the call forward.
5. Press the **Save** soft key to accept the change.

## Dynamic Forwarding

To forward an incoming call to another party:

1. When the phone is ringing, press the **Forward** soft key.
2. Enter the number you want to forward the incoming call to.

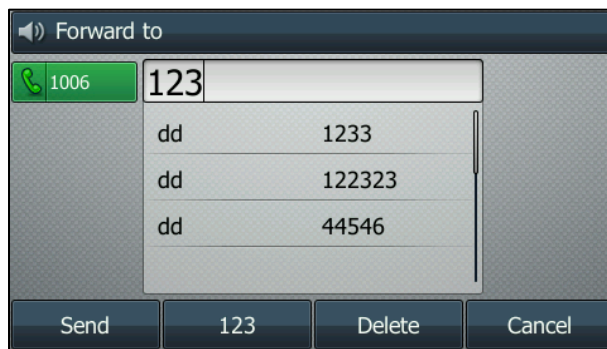

3. Press , , or the **Send** soft key.

The LCD screen prompts a call forward message.

### Note

When the phone forwards a call, the forward call prompt window will pop up by default, if you want to disable the feature, contact your system administrator for more information.

## Call Transfer

You can transfer a call to another party in one of three ways:

- **Blind Transfer:** Transfer a call directly to another party without consulting.
- **Semi-Attended Transfer:** Transfer a call when the target phone is ringing.
- **Attended Transfer:** Transfer a call with prior consulting.

To perform a blind transfer:





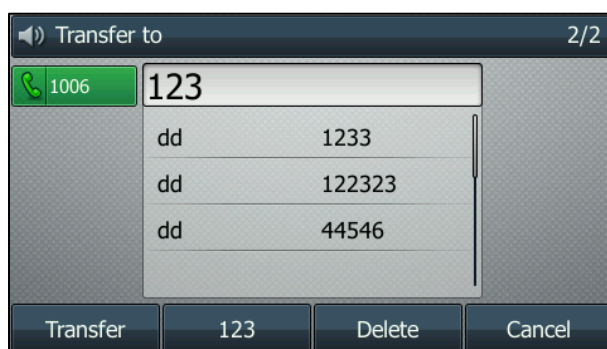

1. Press  or the **Transfer** soft key during a call.

2. Enter the number you want to transfer the call to.





3. Press  to complete the transfer.  
Then the call is connected to the number to which you are transferring.

#### To perform a semi-attended transfer:



1. Press  or the **Transfer** soft key during a call.
2. Do one of the following:
  - Press the **Directory** soft key, and then select **Local Directory**. Select the desired group and search for the contact (Directory should be configured in advance. Refer to [Directory](#) on page 35 for more information).
  - Press the **Directory** soft key, and then select **History**. Select the desired list and then press  or  to select the entry (Directory should be configured in advance. Refer to [Directory](#) on page 35 for more information).
  - Press the **Directory** soft key, and then select **Remote Phone Book**. Select the desired group and search for the contact (Directory should be configured in advance. Refer to [Directory](#) on page 35 and [Remote Phone Book](#) on page 51 for more information).
3. Press  or  to dial out.
4. Press  or the **Transfer** soft key to complete the transfer when receiving ringback.

#### To perform an attended transfer:

1. Press  or the **Transfer** soft key during a call.
2. Do one of the following:
  - Enter the number you want to transfer the call to.
  - Press the **Directory** soft key, and then select **Local Directory**. Select the desired group and search for the contact (Directory should be configured in advance. Refer to [Directory](#) on page 35 for more information).
  - Press the **Directory** soft key, and then select **History**. Select the desired list and then press  or  to select the entry (Directory should be configured in



advance. Refer to [Directory](#) on page 35 for more information).





- Press the **Directory** soft key, and then select **Remote Phone Book**. Select the desired group and search for the contact (Directory should be configured in advance. Refer to [Directory](#) on page 35 and [Remote Phone Book](#) on page 51 for more information).
3. Press  or  to dial out.
  4. After the party answers the call, press  or the **Transfer** soft key to complete the transfer.

If you are using a handset, the transfer can be completed by hanging up the handset. You can cancel the transfer before the call is connected by pressing the **Cancel** soft key.

## Call Waiting

You can enable or disable call waiting on the phone. If call waiting is enabled, you can receive another call while there is already an active call on the phone. Otherwise, another incoming call is automatically rejected by the phone with a busy message when there is an active call on the phone. You can also enable or disable the phone to play a warning tone when receiving another call.

**To configure call waiting via phone user interface:**

1. Press **Menu->Features->Call Waiting**.
2. Press  or  , or the **Switch** soft key to select **Enabled** from the **Call Waiting** field.
3. Press  or  , or the **Switch** soft key to select **Enabled** from the **Play Tone** field.
4. (Optional.) Enter the call waiting on code or off code respectively in the **On Code** or **Off Code** field.

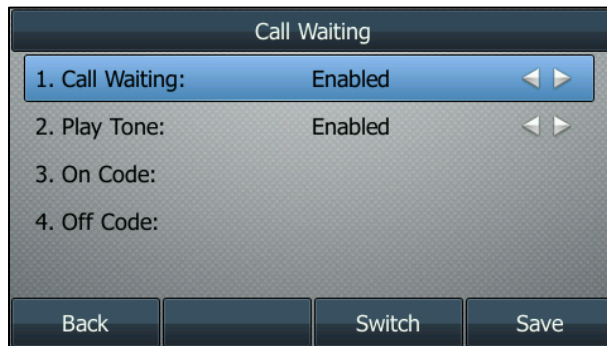

5. Press the **Save** soft key to accept the change or the **Back** soft key to cancel.

Call waiting is configurable via web user interface at the path **Features->General Information**.



## Conference

You can create a conference with other two parties using the phone's local conference. You can create a conference between an active call and a call on hold by pressing the Conference soft key. The SIP-T46G also supports network conference.

### Note

Network conference is not available on all servers. For more information, contact your system administrator.



## Local Conference

The SIP-T46G IP phone supports up to 3 parties (including yourself) in a conference call. This is the default method of conference called Local Conference.

### To set up a local conference call:



1. Place a call to the first party.
2. When the first party answers the call, press the **Conference** soft key to place a new call.

The active call is placed on hold.





3. Enter the number of the second party and then press  ,  , or the **Send** soft key.
4. When the second party answers the call, press the **Conference** soft key again to join all parties in the conference.



### To join two calls in a conference:

1. Place two calls using two different accounts on the phone (for example, place the first call using account 1, and then place the second call using account 2).
2. Press  or  to select the call for conference and ensure that the call is active (for example, select the call on account 1).
3. Press the **Conference** soft key to join the two calls in the conference on the selected account.

**During the conference call, you can do the following actions:**

- Press  or the **Hold** soft key to place the conference on hold.
- Press the **Split** soft key to split the conference call into two individual calls on hold.
- Press the **Manage** soft key, and then press  or  to select the desired party:
  - Press the **Far Mute** soft key to forbid the party from speaking. The muted party can hear everyone, but no one can hear the muted party.
  - Press the **Remove** soft key to remove the party from the conference call.
  - Press the **Back** soft key to return to the previous interface.
- Press  to mute the conference call.
- Press the **End Call** soft key to drop the conference call.

## Network Conference

You can use network conference feature on the SIP-T46G IP phone to conduct a conference with multiple participants.

This feature allows you to perform the following:

- Join two calls together into a conference call.
- Invite another party into an active conference call.

To use this feature, contact your system administrator for the network conference URI in advance.

To use this feature, contact your system administrator for the network conference URI in advance.

**To configure network conference via web user interface:**

1. Click on **Account->Advanced**.
2. Select **Network Conference** from the pull-down list of **Conference Type**.

- Enter the conference URI (e.g., conference@example.com) in the **Conference URI** field.

The screenshot shows the Yealink T46G web interface. The top navigation bar includes 'Status', 'Account', 'Network', 'DSSKey', 'Features', 'Settings', 'Directory', and 'Security'. The 'Account' tab is active, and the 'Advanced' sub-tab is selected. The 'Conference Type' and 'Conference URI' fields are highlighted with a red box. The 'Conference Type' is set to 'Network Conference' and the 'Conference URI' is 'conference@example.com'. Other settings include 'Keep Alive Type' (Default), 'Keep Alive Interval (Seconds)' (30), 'Local SIP Port' (5062), 'RPort' (Disabled), and 'SIP Session Timer T1 (0.5~10s)' (0.5). A 'NOTE' section on the right states: 'Advanced: The Advanced parameters for administrator.'

- Click **Confirm** to accept the change.

#### Note

Network conference is configurable via web user interface only.

#### To set up a network conference call:

- Place a call to the first party.
- Press the **Conference** soft key to place a new call.  
The active call is placed on hold.
- Enter the number of the second party and then press **OK**, **# SEND**, or the **Send** soft key.
- When the second party answers the call, press the **Conference** soft key to add the second party to the conference.
- Press the **Conference** soft key to place a new call.  
The conference is placed on hold.
- Enter the number of the new party and then press **OK**, **# SEND**, or the **Send** soft key.
- When the new party answers the call, press the **Conference** soft key to add the new party to the conference.
- Repeat steps 5 to 7 until you have added all intended parties.

The procedures to set up a network conference call on specific servers may be different from introduced above. Contact your system administrator for more information.







## Call Park

You can use call park to place a call on hold, and then retrieve the call from another phone in the system (for example, a phone in another office or conference room). You can park an active call by pressing the call park key on the phone. If the call is parked successfully, the response is either a voice prompt confirming that the call was parked, or a visible prompt on the LCD screen.

**Note**

Call park is not available on all servers. Contact your system administrator for more information.

**To configure a call park key via phone user interface:**

1. Press **Menu->Features->DSS Keys**.
2. Select the desired DSS key.
3. Press  or  , or the **Switch** soft key to select **Key Event** from the **Type** field.
4. Press  or  , or the **Switch** soft key to select **Call Park** from the **Key Type** field.
5. Press  or  , or the **Switch** soft key to select the desired line from the **Account ID** field.
6. Enter the call park code in the **Value** field.
7. (Optional.) Enter the string that will appear on the LCD screen in the **Label** field.



8. Press the **Save** soft key to accept the change or the **Back** soft key to cancel.

Call park key is configurable via web user interface at the path **DSSKey->Line Key**.

**To use call park:**

1. User on phone A places a call to phone B.
2. User on phone A wants to take the call in a conference room for privacy, and so presses the call park key on phone A.

3. User on phone A walks to an available conference room where the phone is designated as phone C. The user dials the call park retrieve code to retrieve the parked call.

The system establishes call between phone C and B.

**Note**

The call park code and call park retrieve code are predefined on the system server. Contact your system administrator for more information.

If the parked call is not retrieved within a period of time assigned by the system, the phone performing call park will receive a call back.

## Call Pickup

You can use call pickup to answer someone else's incoming call on your phone. The SIP-T46G IP phone supports directed call pickup and group call pickup. Directed call pickup is used for picking up a call that is ringing at a target phone number. Group call pickup is used for picking up a call that is ringing at any phone number in a certain group. The pickup group should be predefined, contact your system administrator for more information.

You can pick up an incoming call by using the **DPickup/Gpickup** soft key. To use call pickup, you need to configure the call pickup code beforehand on a global or per-line basis via web user interface.

**Note**

If there are many incoming calls at the same time, pressing the **Gpickup** soft key on the phone will pick up the call that rings first.

### Directed Call Pickup

To enable directed call pickup and configure the directed call pickup code on a global basis via web user interface:

1. Click on **Features->Call Pickup**.
2. Select **Enabled** from the pull-down list of **Directed Call Pickup**.

3. Enter the directed call pickup code in the **Directed Call Pickup Code** field.

The screenshot shows the 'Call Pickup' configuration page in the Yealink T46G web interface. The 'Features' tab is selected. The 'Directed Call Pickup' dropdown menu is set to 'Enabled', and the 'Directed Call Pickup Code' text input field contains the value '\*97'. A red rectangular box highlights these two fields. Below these, there are settings for 'Group Call Pickup' (Disabled), 'Group Call Pickup Code' (empty), 'Visual Alert for BLF Pickup' (Disabled), and 'Audio Alert for BLF Pickup' (Disabled). At the bottom of the form are 'Confirm' and 'Cancel' buttons. A 'NOTE' box on the right states: 'Call Pickup The call pickup parameters for administrator.'

4. Click **Confirm** to accept the change.

To configure the directed call pickup code on a per-line basis via web user interface:

1. Click on **Account**.
2. Select the desired account from the pull-down list of **Account**.
3. Click on **Advanced**.
4. Enter the directed call pickup code in the **Directed Call Pickup Code** field.

The screenshot shows the 'Account' configuration page in the Yealink T46G web interface. The 'Account' dropdown is set to 'Account 1'. The 'Advanced' tab is selected. The 'Directed Call Pickup Code' text input field contains the value '\*97' and is highlighted with a red rectangular box. Other settings include 'Keep Alive Type' (Default), 'Keep Alive Interval (Seconds)' (30), 'Local SIP Port' (5062), 'RPort' (Disabled), 'SIP Session Timer T1 (0.5~10s)' (0.5), 'SIP Session Timer T2 (2~40s)' (4), 'SIP Session Timer T4 (2.5~60s)' (5), 'Subscribe Period (Seconds)' (1800), and 'DTMF Type' (RFC2833). At the bottom of the form are 'Confirm' and 'Cancel' buttons. A 'NOTE' box on the right states: 'Advanced The Advanced parameters for administrator.'

5. Click **Confirm** to accept the change.

**To pick up a call directly:**

1. Pick up the handset.
2. The **DPickup** soft key appears on the LCD screen.



3. Press the **DPickup** soft key on your phone when the target phone receives an incoming call.
4. Enter the phone number which is receiving an incoming call.
5. Press the **DPickup** soft key again.

The call is answered on your phone.

You can also configure a DSS key as a directed pickup key via phone user interface or web user interface. Once configured, you can pick up a call by pressing the directed pickup key directly.

## Group Call Pickup

**To enable group call pickup and configure the group call pickup code on a global basis via web user interface:**

1. Click on **Features->Call Pickup**.
2. Select **Enabled** from the pull-down list of **Group Call Pickup**.

3. Enter the group call pickup code in the **Group Call Pickup Code** field.

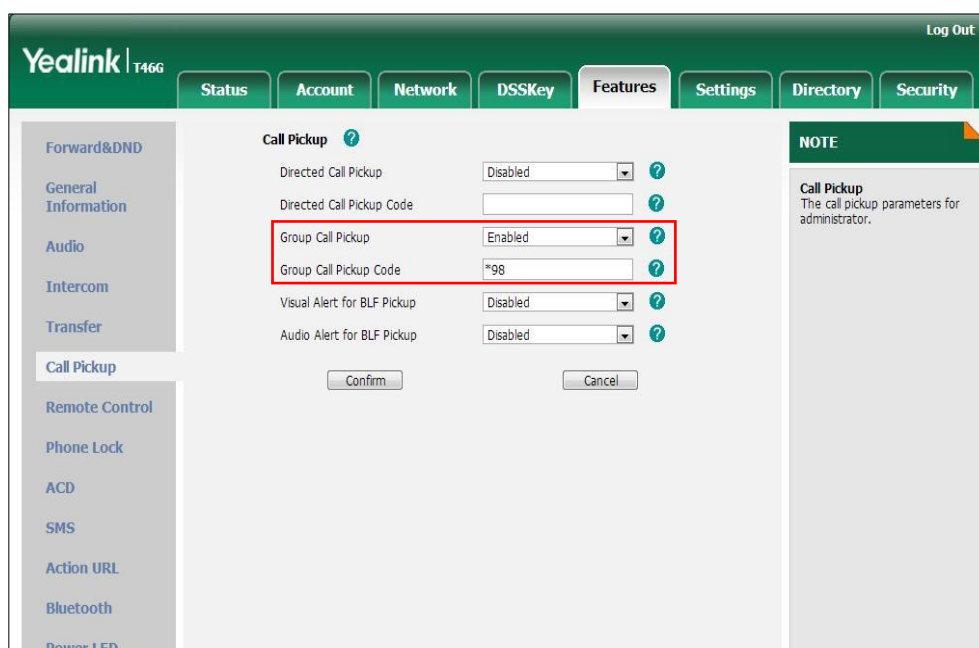

4. Click **Confirm** to accept the change.

To configure the group call pickup code on a per-line basis via web user interface:

1. Click on **Account**.
2. Select the desired account from the pull-down list of **Account**.
3. Click on **Advanced**.
4. Enter the group call pickup code in the **Group Call Pickup Code** field.

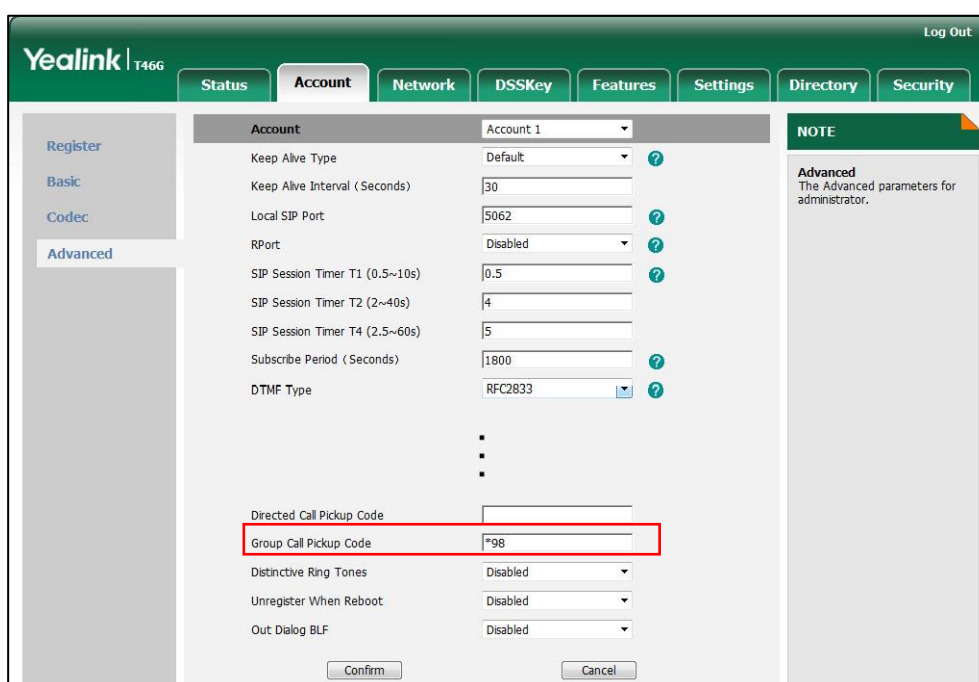

5. Click **Confirm** to accept the change.



**To pick up a call in the group:**

1. Pick up the handset.
2. The **Gpickup** soft key appears on the LCD screen.



3. Press the **Gpickup** soft key on your phone when a phone in the group receives an incoming call.

The call is answered on your phone.

You can also configure a DSS key as group pickup key via phone user interface or web user interface. Once configured, you can pick up a call by pressing the group pickup key directly.

**Note**

The directed call pickup code and group call pickup code are predefined on the system server. Contact your system administrator for more information.

The call pickup code configured on a per-line basis takes precedence over that configured on a global basis.

## Anonymous Call

You can use anonymous call to block your identify and phone number from appearing to the called party when you call someone. For example, you want to call to consult some of the services, but don't want to be harassed. Anonymous call is configurable on a per-line basis. You can also configure the phone to send anonymous call on/off code to the server to activate/deactivate anonymous call on the server side.

**Note**

Anonymous call is not available on all servers. Contact your system administrator for the anonymous call on code and off code.

**To configure anonymous call via phone user interface:**

1. Press **Menu->Features->Anonymous**.
2. Select the desired line and then press **Enter** soft key.
3. Press **◀** or **▶** , or the **Switch** soft key to select **Enabled** from the **Local Anonymous** field.

4. (Optional.) Press ◀ or ▶ , or the **Switch** soft key to select the desired value from the **Send Anonymous Code** field.
5. (Optional.) Enter the anonymous call on code and off code respectively in the **On Code** and **Off Code** field.

The phone will send the configured on code or off code depending on your selection when you enable or disable anonymous call feature on the phone.

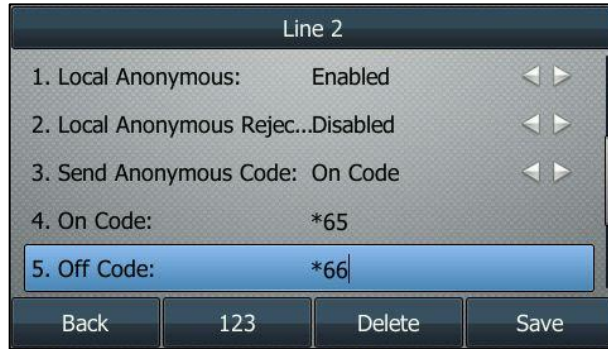

6. Press the **Save** soft key to accept the change or the **Back** soft key to cancel.

Anonymous call is configurable via web user interface at the path **Account->Basic**.

**To place an anonymous call:**

1. Using the specific line on the phone to place a call to phone B.  
The LCD screen of phone B prompts an incoming call from anonymity.



## Anonymous Call Rejection

You can use anonymous call rejection to reject incoming calls from anonymous callers. Anonymous call rejection automatically rejects incoming calls from callers who deliberately block their identities and numbers from being displayed. Anonymous call rejection is configurable on a per-line basis. You can also configure the phone to send anonymous call rejection on/off code to the server to activate/deactivate anonymous call rejection on the server side.

To configure anonymous call rejection via phone user interface:

1. Press **Menu->Features->Anonymous**.
2. Select the desired line and then press **Enter** soft key.
3. Press  $\uparrow$  or  $\downarrow$  to scroll to the **Local Anonymous Rejection** field.
4. Press  $\leftarrow$  or  $\rightarrow$  , or the **Switch** soft key to select **Enabled** from the **Local Anonymous Rejection** field.
5. (Optional.) Press  $\leftarrow$  or  $\rightarrow$  , or the **Switch** soft key to select the desired value from the **Send Anonymous Rejection Code** field.
6. (Optional.) Enter the anonymous call rejection on code and off code respectively in the **On Code** and **Off Code** field.



The phone will send the configured on code or off code depending on your selection when you enable or disable local anonymous rejection feature on the phone.

7. Press the **Save** soft key to accept the change or the **Back** soft key to cancel.

Anonymous call rejection is configurable via web user interface at the path **Account->Basic**.



# Advanced Phone Features

This chapter provides operating instructions for the advanced features of the SIP-T46G IP phone. Topics include:

- [Busy Lamp Field \(BLF\)](#)
- [BLF List](#)
- [Call Recording](#)
- [Hot Desking](#)
- [Intercom](#)
- [Multicast Paging](#)
- [Music on Hold](#)
- [Automatic Call Distribution \(ACD\)](#)
- [Messages](#)





If you require additional information or assistance with your new phone, contact your system administrator.

## Busy Lamp Field (BLF)

You can use BLF to monitor a specific line for status changes on the phone. For example, you can configure a BLF key on the phone to monitor the status of a friend's line (busy or idle). The BLF key LED illuminates solid red when the friend's line is in use. For more information on BLF key LED indications, refer to [LED Instructions](#) on page 4.

You can press a BLF key to dial out the monitored phone number when the monitored line is idle. You can receive a visual or/and an audio alert (if enabled), and also pick up calls that are received on the monitored line. For more information, contact your system administrator.

**To configure a BLF key via phone user interface:**

1. Press **Menu->Features->DSS Keys**.
2. Select the desired DSS key.
3. Press  or  , or the **Switch** soft key to select **BLF** from the **Type** field.
4. Press  or  , or the **Switch** soft key to select the desired line from the **Account ID** field.
5. Enter the phone number or extension you want to monitor in the **Value** field.
6. (Optional.) Enter the string that will appear on the LCD screen in the **Label** field.

- (Optional.) Enter the pickup code in the **Extension** field.

Line Key 9	
1. Type:	BLF
2. Account ID:	Line 1
3. Label:	
4. Value:	1000
5. Extension:	*33

Buttons: Back, 123, Delete, Save

- Press the **Save** soft key to accept the change or the **Back** soft key to cancel.

BLF key is configurable via web user interface at the path **DSSKey->Line Key**.

You can enable audio alert feature for BLF pickup on the phone. This allows the monitoring phone to play a warning tone when the monitored line receives an incoming call. You can also enable visual alert feature for BLF pickup on the phone. This allows the LCD screen of the monitoring phone to display the caller ID when the monitored line receives an incoming call.

**To enable visual and audio alert features via web user interface:**

- Click on **Features->Call Pickup**.
- Select **Enabled** from the pull-down list of **Visual Alert for BLF Pickup**.
- Select **Enabled** from the pull-down list of **Audio Alert for BLF Pickup**.

Yealink T46G | Log Out

Navigation: Status, Account, Network, DSSKey, **Features**, Settings, Directory, Security

Left Menu: Forward&DND, General Information, Audio, Intercom, Transfer, **Call Pickup**, Remote Control, Phone Lock, ACD, SMS, Action URL, Bluetooth, Power LED

**Call Pickup**

- Directed Call Pickup: Disabled
- Directed Call Pickup Code: [ ]
- Group Call Pickup: Disabled
- Group Call Pickup Code: [ ]
- Visual Alert for BLF Pickup: Enabled**
- Audio Alert for BLF Pickup: Enabled**

Buttons: Confirm, Cancel

**NOTE**  
Call Pickup  
The call pickup parameters for administrator.

- Click **Confirm** to accept the change.

**Note** Visual and audio alert features are configurable via web user interface only.

When the monitored line receives an incoming call, the following occurs on your phone:

- The phone plays a warning tone (if enabled).
- The BLF key LED flashes red.
- The caller ID appears on the LCD screen (if enabled).

In the following figure, the LCD screen shows an incoming call from Joy on the monitored line.



#### Note

If your phone is locked and the type of the phone lock is configured as **Function Keys** or **All Keys**, you cannot use the **Pickup**, **Send**, **New Call** and **Cancel** soft keys until unlocked.

When there is an active call on the IP phone, you can transfer the active call to the monitored phone number directly by pressing the BLF key. The phone handles the active call differently depending on the transfer mode via DSS key. For more information on the transfer mode on DSS key, refer to transfer in [DSS Keys](#) section on page 62.

## BLF List

You can use the BLF List feature to monitor a list of users defined by your system administrator. For example, your system administrator enables BLF List, and creates a BLF List URI (e.g., BLFList@example.com) including a list of user1, user2 on the server. The BLF List keys on the IP phone can present the status of user1 and user2. The key LEDs illuminate either flashing or solid depending on the status of those users. For more BLF List key LED indications, refer to [LED Instructions](#) on page 4.

You can use the BLF List keys in the following ways:

- When the monitored user is idle, press the BLF list key to dial out the phone number.
- When there is already an active call on the IP phone, you can transfer the active call to the monitored user by pressing the BLF List key. The phone handles the active call differently depending on the transfer mode on DSS key. For more information on the transfer mode on DSS key, refer to [Transfer](#) on page 70.
- When the monitored user receives an incoming call, press the BLF list key to pick up

the call directly. Before picking up an incoming call, ensure that the directed pickup code has been configured in advance. If the directed pickup code is not configured, the phone will place a call to the monitored user instead of picking up the incoming call of the monitored user when you press the BLF List key.

- When there is a conversation on the monitored user, press the BLF list key to barge in and set up a conference call. Before barging in an active call, ensure that the barge-in code has been configured in advance. If the BLF list barge in code is not configured, the phone will place a call to the monitored user instead of barging in an active call of the monitored user when you press the BLF List key.
- When a call is being parked against the monitored phone, press the BLF List key to retrieve the parked call from the monitored user. Before retrieving the parked call, ensure that the BLF List Retrieve call parked Code has been configured in advance. If the code is not configured, the phone will place a call to the monitored user instead of retrieving the parked call when you press the BLF List key.

**To configure BLF List settings via web user interface:**

1. Click on **Account->Advanced**.
2. Select the desired account from the pull-down list of **Account**.
3. Enter the BLF List URI in the **BLF List URI** field.
4. (Optional.) Enter the directed pickup code in the **BLF List code** field.
5. (Optional.) Enter the barge-in code in the **BLF List Barge In Code** field.
6. (Optional.) Enter the call park retrieve code in the **BLF List Retrieve call parked Code** field.

The screenshot shows the Yealink T46G web user interface. The top navigation bar includes 'Status', 'Account', 'Network', 'DSSKey', 'Features', 'Settings', 'Directory', and 'Security'. The 'Account' section is active, showing 'Account 1' selected. The 'Advanced' settings are displayed, with a red box highlighting the following fields:

BLF List URI	4609@pbx.yealink.com
BLF List Code	*97
BLF List Barge In Code	*33
BLF List Retrieve call parked Code	*88

Other visible settings include: Keep Alive Type (Default), Keep Alive Interval (30), Shared Line (Disabled), Dialog Info Call Pickup (Disabled), BLA Number, Group Call Pickup Code, Distinctive Ring Tones (Enabled), Unregister When Reboot (Disabled), Out Dialog BLF (Disabled), VQ RTPC-XR Collector name, VQ RTPC-XR Collector address, VQ RTPC-XR Collector port (5060), and Accept SIP Trust Server Only (Disabled). A 'NOTE' section on the right states: 'Advanced: The Advanced parameters for administrator. You can click here to get more help through downloading the Administrator Guide!'.



- Click **Confirm** to accept the change.

**Note**

For more information on BLF List URI/BLF List Code/BLF List Barge In Code/BLF List Retrieve Call Parked Code, contact your system administrator.

According to the response message from the server, the IP phone will automatically configure the BLF List keys beginning from the first unused DSS key (The default order of BLF list keys assigned automatically is Line Key->Ext Key). Once any DSS key is seized, the IP phone will skip to configure the next DSS key.

You can receive a visual or/and an audio alert (if enabled) on your phone when the monitored user receives an incoming call. For more information, refer to [Busy Lamp Field \(BLF\)](#) on page 125.

**Note**

The pickup code is used in the following order of preference: BLF List Code (Account->Advanced)>Directed Call Pickup Code (Account->Advanced)>Directed Call Pickup Code (Features->Call Pickup). If all of them are not configured, pressing the BLF List key will directly call the monitored user when he/she receives an incoming call. For more information about pickup Code, refer to [Call Pickup](#) on page 117.

## Call Recording

You can record calls by pressing a record key on the phone. The SIP-T46G IP phone supports record and URL record.





Two ways of call recording:

- Record:** The phone sends SIP INFO message containing a specific header "Record: on/off" to trigger a recording.
- URL Record:** The phone sends HTTP URL request to trigger a recording. Contact your system administrator for the predefined URL.

**Note**

Call record is not available on all servers. Contact your system administrator for more information.

**To configure a record key via phone user interface:**

- Press **Menu->Features->DSS Keys**.
- Select the desired DSS key.
- Press  or  , or the **Switch** soft key to select **Key Event** from the **Type** field.
- Press  or  , or the **Switch** soft key to select **Record** from the **Key Type** field.

- (Optional.) Enter a string that will appear on the LCD screen in the **Label** field.



- Press the **Save** soft key to accept the change or the **Back** soft key to cancel.

**To configure a URL record key via phone user interface:**

- Press **Menu->Features->DSS Keys**.
- Select the desired DSS key.
- Press  $\leftarrow$  or  $\rightarrow$  , or the **Switch** soft key to select **URL Record** from the **Type** field.
- (Optional.) Enter a string that will appear on the LCD screen in the **Label** field.
- Enter the URL (e.g., `http://10.1.2.224/phonerecording.cgi`) in the **URL Record** field.



- Press the **Save** soft key to accept the change or the **Back** soft key to cancel.

Record and URL record keys are configurable via web user interface at the path **DSSKey->Line Key**.

**The Record and URL Record keys control the recording function, and are available:**

- During an active call
- When calls are on hold or muted
- During a blind or attended transfer
- During a conference call
- When the phone prompts you to answer an incoming call

**The Record and URL Record keys are not available when:**





- There are no connected calls on your phone

- You place a new call

#### To record a call:

1. Press the Record or URL Record key during a call.  
If the recording starts successfully, the recording icon will appear on the LCD screen and the Record or URL Record key LED will flash green.
2. Press the Record or URL Record key again to stop recording.  
The recording icon disappears from the LCD screen and the Record or URL Record key LED goes out.

Recording status indications you need to know:

Circumstance	Icons on the LCD screen
A recording is started	 appears on the LCD screen
A recording cannot be started	 appears for 1 second
A recording cannot be stopped	 appears for 1 second, then goes back
The recording box is full	 appears for 1 second
The call cannot be recorded	 appears for 1 second

You can listen to the recordings stored on your server system. For example, you can dial an access code to listen to the recordings.

#### Note

The way in which you listen to the recordings may be different depending on the server. Contact your system administrator for more information.

## Hot Desking

Hot desking originates from the definition of being the temporary physical occupant of a work station or surface by a particular employee. A primary motivation for hot desking is cost reduction. This feature is regularly used in places where not all the employees are in the office at the same time, or not in the office for very long, which means that actual personal offices would be often vacant, consuming valuable space and resources.

You can use hot desking on the SIP-T46G IP phone to log out of existing accounts and then log into a new account. As a result, many users can share the phone resource at different times. To use this feature, you need to configure a hot desking key in advance.

#### Note

Hot desking is not available on all servers. Contact your system administrator for more information.

**To configure a hot desking key via phone user interface:**

1. Press **Menu->Features->DSS Keys**.
2. Select the desired DSS key.
3. Press  $\leftarrow$  or  $\rightarrow$  , or the **Switch** soft key to select **Key Event** from the **Type** field.
4. Press  $\leftarrow$  or  $\rightarrow$  , or the **Switch** soft key to select **Hot Desking** from the **Key Type** field.
5. (Optional.) Enter a string that will appear on the LCD screen in the **Label** field.



6. Press the **Save** soft key to accept the change or the **Back** soft key to cancel.

Hot desking key is configurable via web user interface at the path **DSSKey->Line Key**.

**To use hot desking:**

1. Press the hot desking key when the phone is idle.

The LCD screen prompts the following warning:

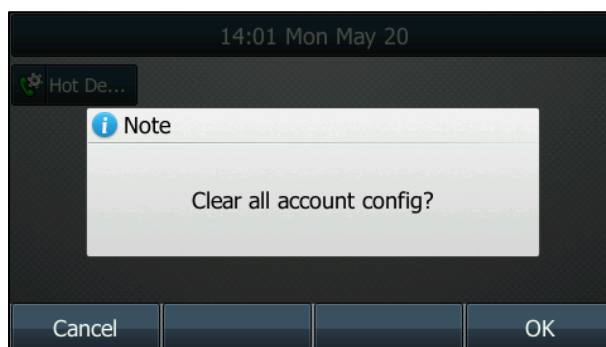

2. Press the **OK** soft key, registration configurations of all accounts on the phone will be cleared immediately.

The login wizard will be displayed as below:

3. Enter the login information in each field.
4. Press the **Save** soft key to login or the **Back** soft key to cancel.

## Intercom

Intercom is a useful feature in an office environment to quickly connect with the operator or the secretary. You can press the intercom key to automatically connect with a remote extension for outgoing intercom calls, and the remote extension will automatically answer incoming intercom calls.

### Note

Intercom is not available on all servers. Contact your system administrator for more information.

## Outgoing Intercom Calls

To configure an intercom key via phone user interface:

1. Press **Menu->Features->DSS Keys**.
2. Select the desired DSS key.
3. Press **◀** or **▶**, or the **Switch** soft key to select **Intercom** from the **Type** field.
4. Select the desired line from the **Account ID** field.
5. (Optional.) Enter the string that will appear on the LCD screen in the **Label** field.

6. Enter the remote extension number in the **Value** field.

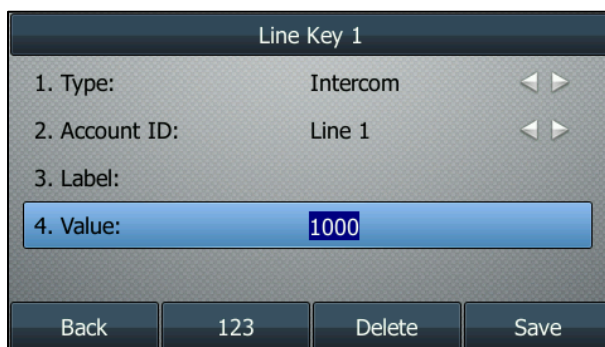

7. Press the **Save** soft key to accept the change or the **Back** soft key to cancel.

Intercom key is configurable via web user interface at the path **DSSKey->Line Key**.

**To place an intercom call:**

1. Press the intercom key when the phone is idle.  
The phone is automatically connected to the extension specified in the **Value** field.
2. Press the intercom key again or the **Cancel** soft key to end the intercom call.

## Incoming Intercom Calls

The SIP-T46G IP phone supports automatically to answer an incoming intercom call by default. The phone automatically plays a warning tone when it receives an incoming intercom call. In addition, you can enable the phone to mute the microphone when it automatically answers an incoming intercom call. You can also enable the phone to automatically answer an incoming intercom call while there is already an active call on the phone. The active call is then placed on hold.

Intercom features you need to know:

Intercom Feature	Description
Accept Intercom	Enable or disable the IP phone to automatically answer an incoming intercom call.
Intercom Mute	Enable or disable the IP phone’s microphone for intercom calls.
Intercom Tone	Enable or disable the IP phone to play a warning tone when it receives an incoming intercom call.
Intercom Barge	Enable or disable the IP phone to automatically answer an incoming intercom call while there is already an active call on the phone.

**To configure intercom features via phone user interface:**

1. Press **Menu->Features->Intercom**.

2. Make the desired changes.

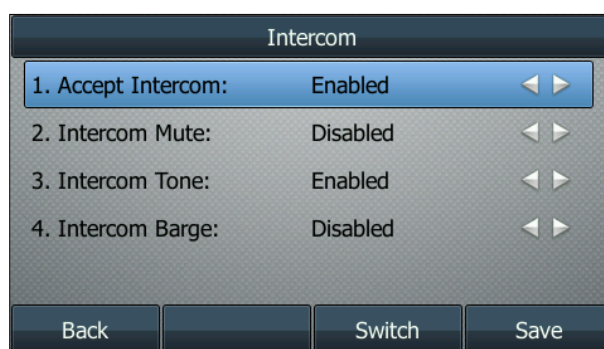

3. Press the **Save** soft key to accept the change or the **Back** soft key to cancel.

These specific parameters are configurable via web user interface at the path **Features->Intercom**.

### Accept Intercom

You can enable or disable the phone to automatically answer an incoming intercom call. If Accept Intercom is enabled, the phone will automatically answer an incoming intercom call. If Accept Intercom is disabled, the phone will reject incoming intercom calls and send a busy message to the caller. Accept Intercom is enabled by default.

#### Note

Your administrator can set a period of delay time before the phone automatically answers intercom calls. Contact your system administrator for more information.

### Intercom Mute

You can mute or un-mute the phone's microphone for intercom calls automatically. If Intercom Mute is enabled, the microphone will be muted for intercom calls. If Intercom Mute is disabled, the microphone will work for intercom calls. Intercom Mute is disabled by default.

### Intercom Tone

You can enable or disable the phone to play a warning tone when receiving an intercom call. If Intercom Tone is enabled, the phone will play a warning tone before answering the intercom call. If Intercom Tone is disabled, the phone will automatically answer the intercom call without warning. Intercom Tone is enabled by default.

### Intercom Barge





You can enable or disable the phone to automatically answer an incoming intercom call while there is already an active call on the phone. If Intercom Barge is enabled, the phone will automatically answer the intercom call and place the active call on hold. If Intercom Barge is disabled, the phone will handle an incoming intercom call like a waiting call. Intercom Barge is disabled by default.

## Multicast Paging

You can use multicast paging to quickly and easily forward out time sensitive announcements to people within the multicast group. You can configure a multicast paging key or a paging list key on the phone, which allows you to send a Real Time Transport Protocol (RTP) stream to the pre-configured multicast address(es) without involving SIP signaling. You can configure the phone to receive an RTP stream from pre-configured multicast listening address(es) without involving SIP signaling. You can specify up to 10 multicast listening addresses.

## Sending RTP Stream

To configure a multicast paging key via phone user interface:

1. Press **Menu->Features->DSS Keys**.
2. Select the desired DSS key.
3. Press  or , or the **Switch** soft key to select **Key Event** from the **Type** field.
4. Press  or , or the **Switch** soft key to select **Paging** from the **Key Type** field.
5. (Optional.) Enter the string that will appear on the LCD screen in the **Label** field.
6. Enter the multicast IP address and port number (e.g., 224.5.6.20:10008) in the **Value** field.





The valid multicast IP addresses range from 224.0.0.0 to 239.255.255.255.



7. Press the **Save** soft key to accept the change or the **Back** soft key to cancel.

Multicast paging key is configurable via web user interface at the path **DSSKey->Line Key**.

To configure a paging list key via phone user interface:

1. Press **Menu->Features->DSS Keys**.
2. Select the desired DSS key.
3. Press  or , or the **Switch** soft key to select **Key Event** from the **Type** field.
4. Press  or , or the **Switch** soft key to select **Paging List** from the **Key Type** field.





- (Optional.) Enter the string that will appear on the LCD screen in the **Label** field.

- Press the **Save** soft key to accept the change or the **Back** soft key to cancel.

Paging list key is configurable via web user interface at the path **DSSKey**.

#### To configure paging list via phone user interface:

- Press the paging list key when the phone is idle.
- Press  or  to select a desired paging group.

The default tag is Empty if it is not configured before.

- Press the **Option** soft key.
- Press the **Edit** soft key.



- Enter the multicast IP address and port number (e.g., 224.5.6.20:10008) in the **Address** field.

The valid multicast IP addresses range from 224.0.0.0 to 239.255.255.255.

6. Enter the group name in the **Label** field.
7. Press the **Save** soft key to accept the change.
8. Repeat the step 2-7, you can add more paging groups.

Paging list is configurable via web user interface at the path: **Directory->Multicast IP**.

**To delete paging group via phone user interface:**

1. Press the Paging list key when the phone is idle.
2. Press  or  to select a desired group.
3. Press the **Option** soft key.
4. Press the **Delete** soft key.

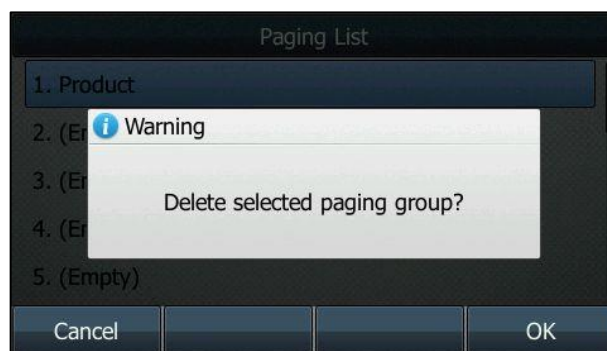

5. Press the **OK** soft key to accept the change or the **Cancel** soft key to cancel.
- If you want to delete all paging group, you can press the **Delete All** soft key.

You can also configure the phone to use a default codec for sending multicast RTP stream via web user interface.

**To configure a default codec for multicast paging via web user interface:**

1. Click on **Features->General Information**.
2. Select the desired codec from the pull-down list of **Multicast Codec**.

The default codec is G722.

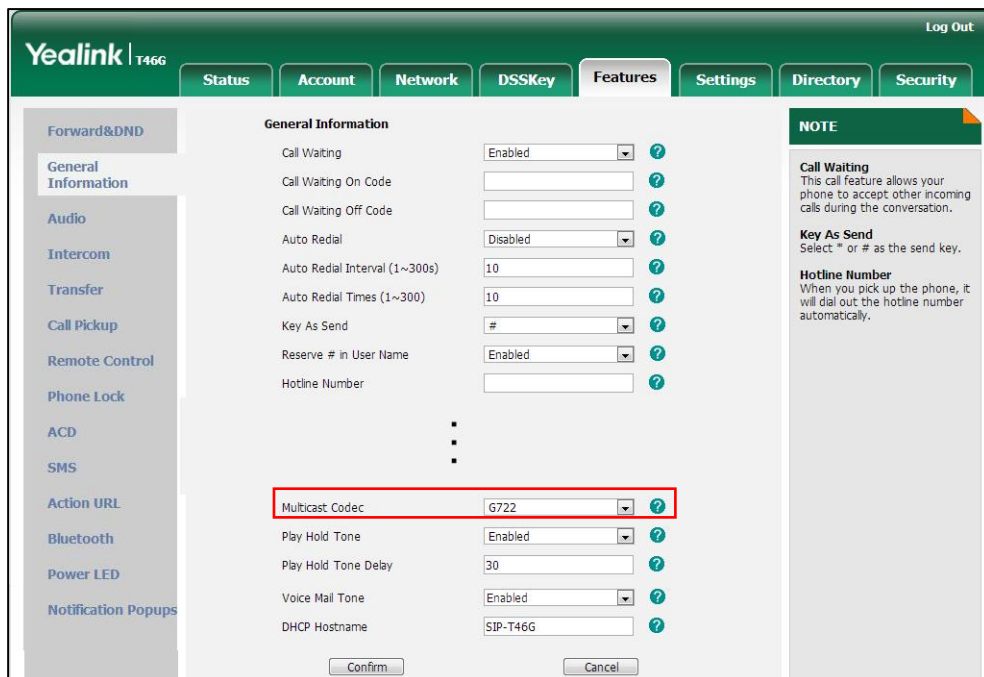

3. Click **Confirm** to accept the change.

#### Note

If G722 codec is used for multicast paging, the LCD screen will display the icon **HD** to indicate that it is providing high definition voice.

Default codec for multicast paging is configurable via web user interface only.

#### To send RTP stream via a multicast paging key:

1. Press the multicast paging key when the phone is idle.

The phone sends RTP to a preconfigured multicast address (IP: Port). Any phone in the local network then listens to the RTP on the preconfigured multicast address (IP: Port). For both sending and receiving of the multicast RTP, there is no SIP signaling involved.

The multicast paging key LED illuminates solid green.

The following figure shows a multicast RTP session on the phone:





2. Press the **Hold** soft key to place the current multicast RTP session on hold.
3. Press the **End Call** soft key to cancel the multicast RTP session.

**Note**

Multicast RTP is one way only from the sender to the multicast address(es) (receiver). For outgoing RTP multicasts, all other existing calls on the phone will be placed on hold.

**To send RTP stream via a paging key list:**

1. Press the paging list key when the phone is idle.
2. Press  or  to select the desired group.



3. Press  or the **Paging** soft key to send RTP.
4. Press the **Hold** soft key to place the current multicast RTP session on hold.
5. Press the **End Call** soft key to cancel the multicast RTP session.

## Receiving RTP Stream

You can configure the phone to receive a Real Time Transport Protocol (RTP) stream from the pre-configured multicast address(es) without involving SIP signaling. You can specify up to 10 multicast addresses that the phone listens to on the network.

How the phone handles incoming multicast paging calls depends on Paging Barge and Paging Priority Active parameters configured via web user interface.

### Paging Barge

The paging barge parameter defines the priority of the voice call in progress. If the priority of an incoming multicast paging call is lower than that of the active call, it will be ignored automatically. If Disabled is selected from the pull-down list of Paging Barge, the voice call in progress will take precedence over all incoming multicast paging calls.

Valid values in the Paging Barge field:

- **1 to 10:** Define the priority of the active call, 1 with the highest priority, 10 with the lowest.
- **Disabled:** The voice call in progress will take precedence over all incoming paging calls.

## Paging Priority Active

The paging priority active parameter decides how the phone handles incoming multicast paging calls when there is already a multicast paging call on the phone. If enabled, the phone will ignore incoming multicast paging calls with lower priorities, otherwise, the phone will answer incoming multicast paging calls automatically and place the previous multicast paging call on hold. If disabled, the phone will automatically ignore all incoming multicast paging calls.

To configure multicast listening addresses via web user interface:

1. Click on **Directory->Multicast IP**.
2. Select the desired value from the pull-down list of **Paging Barge**.
3. Select the desired value from the pull-down list of **Paging Priority Active**.
4. Enter the multicast IP address(es) and port number (e.g., 224.5.6.20:10008) which the phone listens to for incoming RTP multicast in the **Listening Address** field.
5. Enter the label in the **Label** field.

Label will appear on the LCD screen when receiving the multicast RTP stream.



IP Address	Listening Address	Label	Priority
1 IP Address	224.5.6.20:10008	Paging one	1
2 IP Address			2
3 IP Address			3
4 IP Address			4
5 IP Address			5
6 IP Address			6
7 IP Address			7
8 IP Address			8
9 IP Address			9
10 IP Address			10

6. Click **Confirm** to accept the change.

### Note

The priorities of listening addresses are predefined: 1 with the highest priority, 10 with the lowest.

Both the multicast paging sender and receiver's phones play a warning tone when establishing a multicast paging call.

Multicast listening addresses are configurable via web user interface only.

## Music on Hold

Music on hold (MoH) is the business practice of playing recorded music to fill the silence

that would be heard by the party placed on hold. To use this feature, you should specify a SIP URI pointing to a Music on Hold Server account. When a call is placed on hold, the phone will send a SIP INVITE message to the Music on Hold Server account. The Music on Hold Server account automatically answers the SIP INVITE messages and immediately plays audio from some source located anywhere (LAN, Internet) to the held party. Contact your system administrator for the SIP URI.

**To configure music on hold server via web user interface:**

1. Click on **Account**.
2. Select the desired account from the pull-down list of **Account**.
3. Click on **Advanced**.
4. Enter the SIP URI (e.g., sip:moh@sip.com) in the **Music Server URI** field.

The screenshot shows the Yealink T46G web user interface. The top navigation bar includes 'Status', 'Account', 'Network', 'DSSKey', 'Features', 'Settings', 'Directory', and 'Security'. The 'Account' tab is active, and 'Account 1' is selected from a dropdown menu. The 'Advanced' sub-tab is selected in the left sidebar. The main content area displays various configuration fields for the account, including 'Keep Alive Type', 'Keep Alive Interval (Seconds)', 'Local SIP Port', 'RPort', 'SIP Session Timer T1 (0.5~10s)', 'SIP Session Timer T2 (2~40s)', 'SIP Session Timer T4 (2.5~60s)', 'Subscribe Period (Seconds)', and 'DTMF Type'. The 'Music Server URI' field is highlighted with a red box and contains the value 'sip:moh@sip.com'. Other fields like 'Directed Call Pickup Code', 'Group Call Pickup Code', 'Distinctive Ring Tones', 'Unregister When Reboot', and 'Out Dialog BLF' are also visible. A 'NOTE' panel on the right states: 'Advanced: The Advanced parameters for administrator.' At the bottom, there are 'Confirm' and 'Cancel' buttons.

5. Click **Confirm** to accept the change.

When you place a call on hold, the held party can hear the music.

**Note**

For this feature to function, all involved parties cannot use encrypted RTP (SRTP). Music on hold server is configurable via web user interface only.

## Automatic Call Distribution (ACD)

ACD is often used in offices for customer service, such as call center. The ACD system handles large volumes of incoming calls from callers who have no need to talk to a specific person but who require assistance from any of multiple persons at the earliest opportunity. ACD on the SIP-T46G IP phone allows the ACD system to distribute large volumes of incoming calls to the registered ACD users. To use this feature, you should

configure an ACD key in advance.

**Note**

Make sure ACD is enabled on your IP phone. For more information on enabling ACD, contact your system administrator.

**To configure an ACD key via phone user interface:**

1. Press **Menu->Features->DSS Keys**.
2. Select the desired DSS key.
3. Press **◀** or **▶** , or the **Switch** soft key to select **ACD** from the **Type** field.
4. (Optional.) Enter the string that will appear on the LCD screen in the **Label** field.

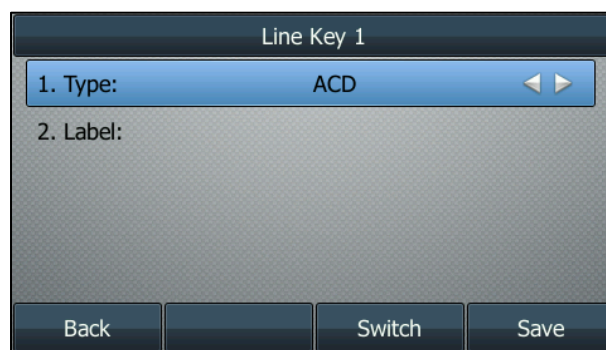

5. Press the **Save** soft key to accept the change or the **Back** soft key to cancel.

ACD key is configurable via web user interface at the path **DSSKey->Line Key**.

**To log into the ACD system:**

1. Press the ACD key when the phone is idle.

The LCD screen prompts you the following information:

**User ID:** the identity used to log into the queue.

**Password:** the password used to log into the queue.

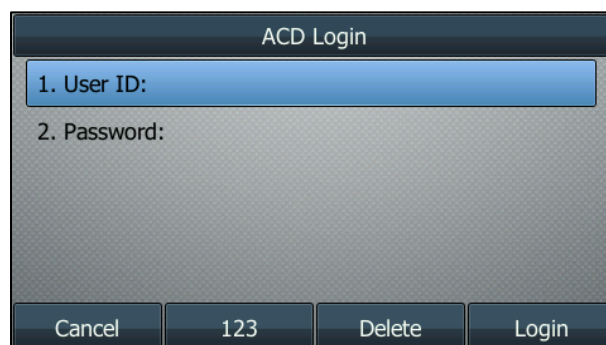

2. Press the **Login** soft key to log in.

**Note**

Contact your system administrator for the User ID and Password to access the ACD system.



After configuring an ACD key, you can press the ACD key to log into the ACD system. After logging in, you are ready to receive calls from the ACD system. You can press the ACD key to show your current ACD user status. You can press the **Available/Unavailable** soft key to change your ACD user status. ACD user status synchronizes on both IP phone and ACD system.

When you set the ACD user status to be available, the ACD key LED illuminates solid green, and then the server begins distributing calls to your phone.

When you set the ACD user status to be unavailable, the ACD key LED flashes green, and then the server temporarily stops distributing calls to your phone. To log out of the ACD system, press the **Logout** soft key.

**Note**

It is recommended you configure no more than one ACD key per phone. At any time, at most one ACD key can be in progress on your phone.

## Messages

### Short Message Service (SMS)

You can send and receive text messages using the SIP-T46G IP phone. New text messages can be indicated both acoustically and visually. When receiving a new text message, the phone will play a warning tone. The power indicator LED will slow flash red, and the LCD screen will prompt receiving new text messages with the number of waiting messages (e.g., 1 New Text Message) and an icon.

**Note**

When the phone receives a text message, the text message prompt window will pop up by default, if you want to disable the feature, contact your system administrator for more information.

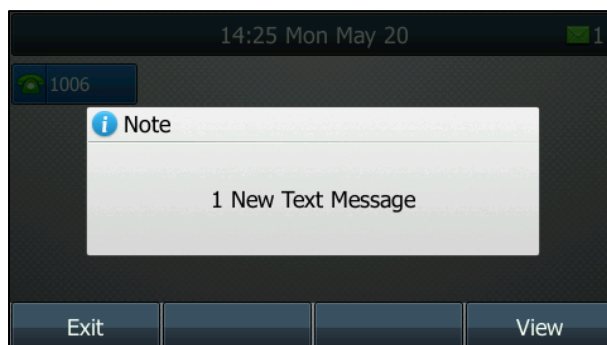

**Note**

SMS is not available on all servers. Contact your system administrator for more information.



**To read a text message:**

1. Press **Menu->Message->Text Message->Inbox**.

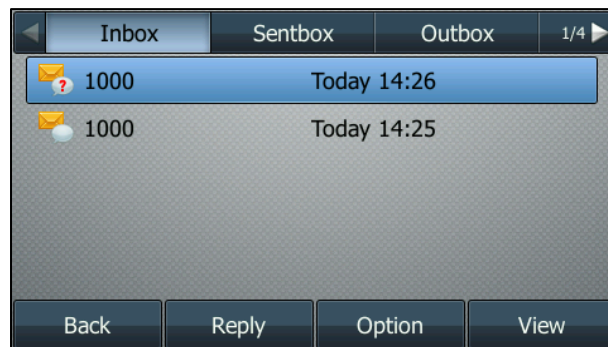

2. Select the desired message and then press the **View** soft key.

**Note**

If the phone prompts receiving new text messages, you can also press the **View** soft key to read the new messages directly.

**To send a text message:**

1. Press **Menu->Message->Text Message->New Message**.
2. Compose the new text message. You can press the **abc** soft key to change the input mode.
3. Press the **Send** soft key.
4. (Optional.) Press **◀** or **▶**, or the **Switch** soft key to select the desired account from the **From** field.
5. Enter the number you want to send the message to in the **To** field.
6. Press the **Send** soft key to send the message or the **Back** soft key to cancel.

Sending a text message is configurable via web user interface at the path **Features->SMS**.

**To reply a text message:**

1. Press **Menu->Message->Text Message->Inbox**.
2. Select the desired message and then press the **Reply** soft key.

3. Compose the new text message. You can press the **abc** soft key to change the input mode.



4. Press the **Send** soft key after completing the content.

**To delete a text message:**

1. Press **Menu->Message->Text Message->Inbox (Sent Box, Outbox or Draftbox)**.
2. Select the desired message and then press the **Option** soft key.

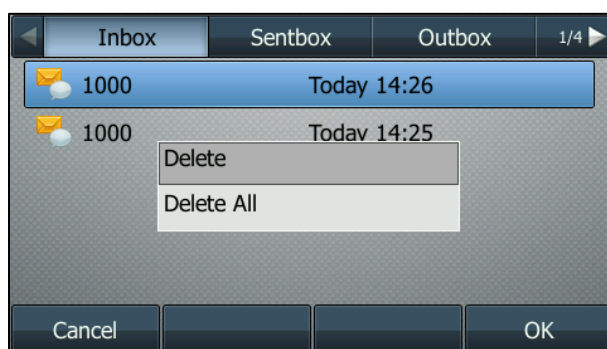

3. Select **Delete** to delete the desired message.

The LCD screen prompts "Delete message?".

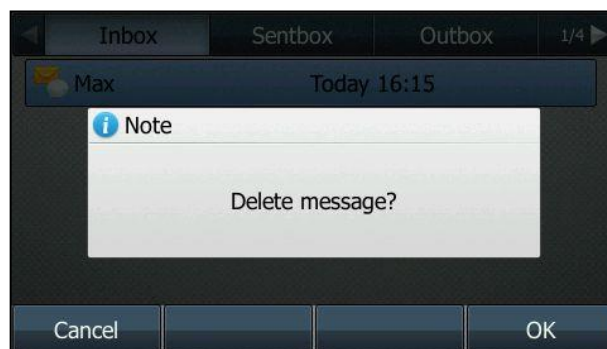

4. Press the **OK** soft key to delete this message or the **Cancel** soft key to cancel. You can also delete all text messages by pressing the **Option** soft key and then select **Delete All**. For more information, refer to the above steps.

**Note**

You can also delete a specific message after retrieving by pressing the **Delete** soft key.

## Voice Mail

You can leave voice mails for someone else using the SIP-T46G IP phone. You can also listen to voice mails that are stored in a voice mailbox. When receiving a new voice mail, the phone will play a warning tone, and the power indicator LED will slow flash red. The LCD screen will prompt that the phone receives a new message with the number of waiting voice mails (e.g., New Voice Mail(1)) and display an icon.

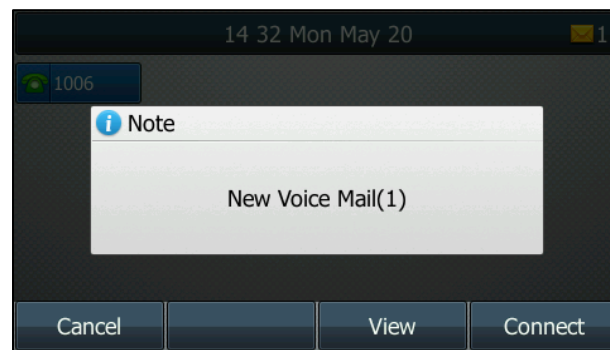

If the voice mail pop-up message box disappears, it won't pop up again unless the user receives a new voice mail or the user re-registers the account that has unread voice mail(s).

### Note

Voice Mail is not available on all servers.

You can configure the phone not to display the pop-up prompt, contact your system administrator for more information.

### To leave a voice mail:

You can leave a voice mail for someone else when he/she is busy or inconvenient to answer the call. Follow the voice prompt from the system server to leave a voice mail, and then hang up.

### To configure voice mail access codes via phone user interface:

1. Press **Menu->Message->Voice Mail->Set Voice Mail**.
2. Press the navigation keys to highlight the account which you want to set.

3. Press the **123** soft key to select the proper input mode and then enter the voice mail access code (e.g., \*97).

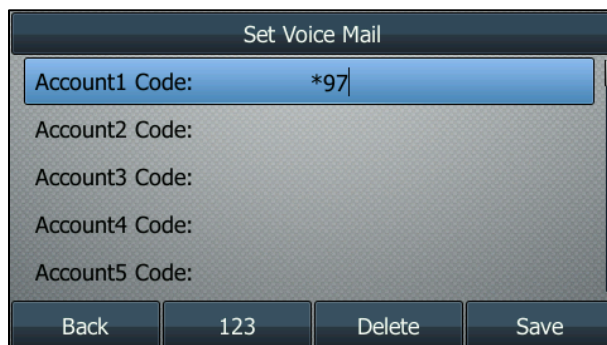

4. Press the **Save** soft key to accept the change or the **Back** soft key to cancel.

**Note** Voice mail access codes must be predefined on the system server. Contact your system administrator for the more information.

**To listen to voice mails:**

1. When the LCD screen prompts that the phone receives a new voice mail and the power indicator LED slow flashes red, press  or the **Connect** soft key to dial out the voice mail access code.
2. Follow the voice prompt to listen to your voice mails.

**Note** Before listening to voice mails, make sure the voice mail access code has been configured.  
When all new voice mails are retrieved, the power indicator LED will go out.

**To view the voice mail via phone user interface:**

1. Press **Menu->Message->Voice Mail->View Voice Mail**.

The LCD screen displays the amount of new and old voice mails



2. Select an account and then press the **Connect** soft key to listen to voice mails.

## Message Waiting Indicator (MWI)

The SIP-T46G IP phone supports MWI when receiving a new voice message. If someone leaves you a voice mail, you will receive a message waiting indicator. MWI will be indicated in three ways: a warning tone, an indicator message (including a voice mail icon) on the LCD screen, and the power indicator LED slow flashes red. This will be cleared when you retrieve all voice mails or delete them.

The MWI service is unsolicited for some servers, so the SIP-T46G IP phone only handles the MWI messages sent from the server. But for other servers, the MWI service is solicited, so the SIP-T46G IP phone must enable subscription for MWI.

**Note** MWI service is not available on all servers. Contact your system administrator for more information.

The MWI subscription parameters you need to know:

Options	Description
<b>Subscribe for MWI</b>	Enable or disable a subscription for MWI service.
<b>MWI Subscription Period</b>	Period of MWI subscription. The IP phone sends a refresh SUBSCRIBE request before initial SUBSCRIBE expiration.
<b>Subscribe MWI to VM</b>	Enable or disable a subscription to the voice mail number for MWI service. To use this feature, you should also configure the voice mail number.

**Note** The phone will send SUBSCRIBE messages for the MWI service to the account or the voice number MWI service depending on the server. Contact your system administrator for more information.

### To configure subscribe for MWI via web user interface

1. Click on **Account**.
2. Select the desired account from the pull-down list of **Account**.
3. Click on **Advanced**.
4. Select **Enabled** from the pull-down list of **Subscribe for MWI**.

5. Enter the period time in the **MWI Subscription Period (Seconds)** field.

The screenshot shows the Yealink T46G web interface. The 'Account' tab is active, and the 'Advanced' sub-tab is selected. The 'Account' dropdown is set to 'Account 1'. The 'MWI Subscription Period(Seconds)' field is highlighted with a red box and contains the value '3600'. Other fields include 'Subscribe for MWI' (Enabled), 'Subscribe Period (Seconds)' (1800), 'DTMF Type' (RFC2833), and 'Voice Mail' (Disabled).

6. Click **Confirm** to accept the change.

The IP phone will subscribe to the account number for MWI service by default.

**To enable Subscribe MWI to Voice Mail via web user interface:**

1. Click on **Account**.
2. Select the desired account from the pull-down list of **Account**.
3. Click on **Advanced**.
4. Select **Enabled** from the pull-down list of **Subscribe MWI To Voice Mail**.
5. Enter the desired voice mail number in the **Voice Mail** field.

The screenshot shows the Yealink T46G web interface. The 'Account' tab is active, and the 'Advanced' sub-tab is selected. The 'Account' dropdown is set to 'Account 1'. The 'Subscribe MWI To Voice Mail' field is highlighted with a red box and contains the value 'Enabled'. The 'Voice Mail' field is also highlighted with a red box and contains the value '1234'. Other fields include 'Subscribe for MWI' (Enabled), 'Subscribe Period (Seconds)' (1800), 'DTMF Type' (RFC2833), and 'Voice Mail' (1234).

6. Click **Confirm** to accept the change.

The IP phone will subscribe to the voice mail number for MWI service using  
Subscribe MWI to Voice Mail.

**Note**

MWI subscription is configurable via web user interface only.





# Troubleshooting

---

This chapter provides general troubleshooting information to help you solve the problems you might encounter when using your SIP-T46G IP phone.

If you require additional information or assistance with your new phone, contact your system administrator.

## Why is the LCD screen blank?

- Ensure that the phone is properly plugged into a functional AC outlet.
- Ensure that the phone is plugged into a socket controlled by a switch that is on.
- If the phone is plugged into a power strip, try to plug it directly into a wall outlet instead.
- If the phone is powered from PoE, ensure that you use a PoE-compliant switch or hub.

## Why does the phone display "Network Unavailable"?

- Ensure that the Ethernet cable is plugged into the Internet port on the phone and the Ethernet cable is not loose.
- Ensure that the switch or hub in your network is operational.

## Why doesn't the phone display time and date correctly?

Check if you have configured the phone to obtain the time and date from the SNTP server automatically. If the phone fails to connect to the SNTP server, you need to configure the time and date manually.

## How do I find the basic information of the IP phone?

Press the OK key when the IP phone is idle to check the basic information of the IP phone, such as IP address and firmware version. For more basic information, refer to [Phone Status](#) on page 15.

## How to obtain the MAC address of a phone when the phone is not powered on?

Three ways to obtain the MAC address of a phone:

- You can ask your supplier for the shipping information sheet which includes MAC addresses according to the corresponding PO (Purchase Order).
- You can find the MAC address on the label of the carton box.

- You can also find the MAC address from the phone's bar code on the back of the phone.

#### **Why can't I get a dial tone?**

- Check for any loose connections and that the phone has been installed properly. For the installation instructions, refer to [Phone Installation](#) on page 11.
- Switch between the Handset, Headset (if present) or Hands-Free Speakerphone to check whether the dial tone is present for one of the audio modes.  
If the dial tone exists on another audio mode, connect a different handset or headset to isolate the problem.

#### **Why doesn't the phone ring?**

Check the ringer volume on the phone. To adjust the ringer volume setting, press the Volume key when the phone is on-hook and idle. For more information, refer to [Volume](#) on page 31.

#### **Why can't I receive calls?**

- Check the SIP registration with your system administrator.
- Check that DND (Do Not Disturb) mode is deactivated on your phone. Refer to [Do Not Disturb \(DND\)](#) on page 99.
- Check that call forward is disabled on the phone. Refer to [Call Forward](#) on page 103.
- Check whether the caller number is stored in the blacklist directory. Refer to [Blacklist](#) on page 49.

#### **Why is my handset not working?**

Check that the handset cord is fully connected to both the handset jack on the phone and handset. Refer to [Phone Installation](#) on page 11.

#### **Why is my headset not working?**

- Check that the headset cord is fully connected to the headset jack on the phone. Refer to [Phone Installation](#) on page 11.
- Check that the headset mode is activated. Refer to [Headset Use](#) on page 55.
- Check that the headset volume is adjusted to an appropriate level. Refer to [Volume](#) on page 31.

#### **What is the difference between user name, register name and display name?**

Both user name and register name are defined by the server. A user name is used to identify the account while a register name matched with a password is used for

authentication if the server requires. Display name is the caller ID that will be displayed on the callee's LCD screen. Server configuration may override the local configuration.

### Why does the phone play a tone when there is a call on hold? How to disable it?

When there is a call on hold, the phone will play a hold tone every 30 seconds. Call hold tone is enabled by default. Call hold tone and the interval of playing a hold tone are configurable via web user interface only.

To configure call hold tone and call hold tone delay via web user interface:

1. Click on **Features->General Information**.
2. Select the desired value from the pull-down list of **Play Hold Tone**.
3. Enter the desired time in the **Play Hold Tone Delay** field.

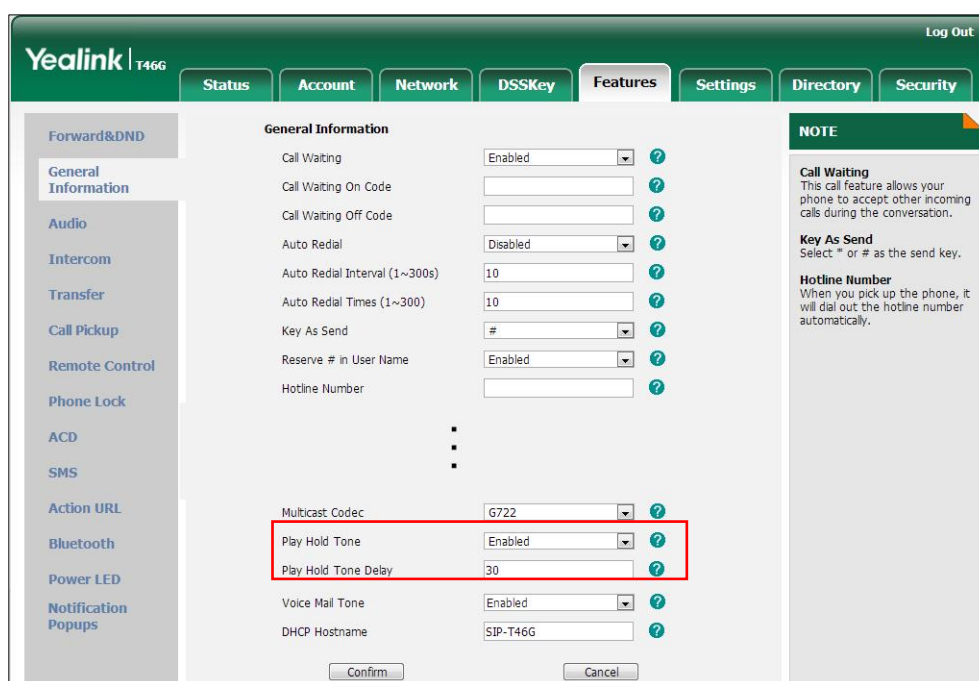

4. Click **Confirm** to accept the change.

### Why does the wallpaper has bad display?

Do one of the following:

- Check that the custom image is clear.
- Check that the file format of the custom image for the wallpaper is \*.jpg, \*.png or \*.bmp.
- Check that the custom image is neither too large nor too small. The phone will adjust the image with the short side to display.
- Check that the picture resolution of the wallpaper. The wallpaper resolution of SIP-T46G IP phone is 480\*272 pixels.

### Why I can't send an SMS to any other phone?

SMS depends on support from a SIP server. Contact your system administrator for more information.

### How to change the user password?

To change the user password via web user interface:

1. Click on **Security->Password**.
2. Select **User** from the pull-down list of **User Type**.
3. Enter the new user password in the **New Password** field and **Confirm Password** field.

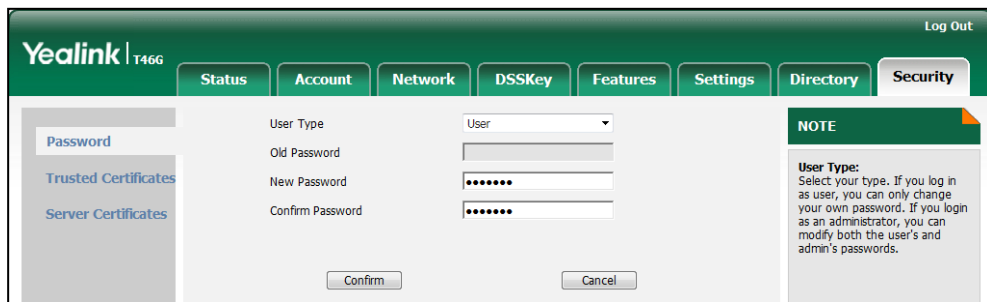

4. Click **Confirm** to accept the change.

You can also contact your system administrator for help.

#### Note

If logging into the web user interface of the phone with user credentials, you need to enter the current user password in the **Old Password** field.

User password is configurable via web user interface only.

### How to make a call using SRTP?

You can enable SRTP to encrypt the audio stream(s) of phone calls. The parties participating in the call should enable SRTP on a per-line basis.

To enable SRTP on a per-line basis via web user interface:

1. Click on **Account**.
2. Select the desired account from the pull-down list of **Account**.
3. Click on **Advanced**.

- Select the desired value (Optional or Compulsory) from the pull-down list of **RTP Encryption (SRTP)**.

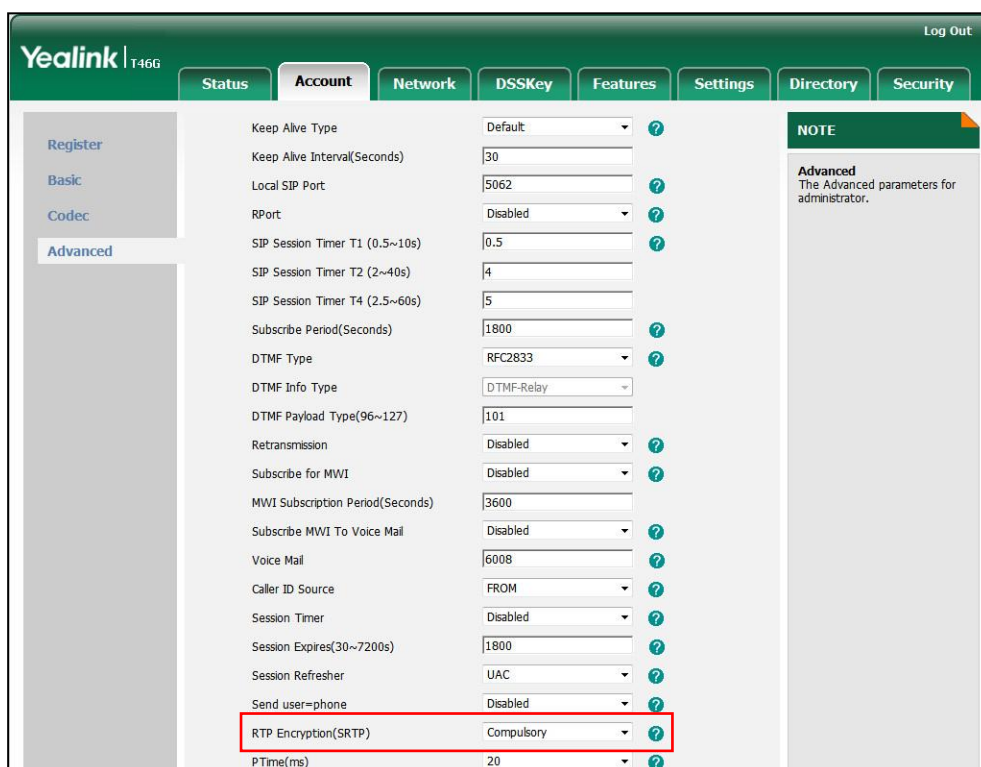

- Click **Confirm** to accept the change.

**Note**

SRTP is not available on all servers. Contact your system administrator for more information.

SRTP is configurable via web user interface only.

**How to reboot the phone?**

To reboot the phone via web user interface:

- Click on **Settings->Upgrade**.
- Click **Reboot** to reboot the IP phone.

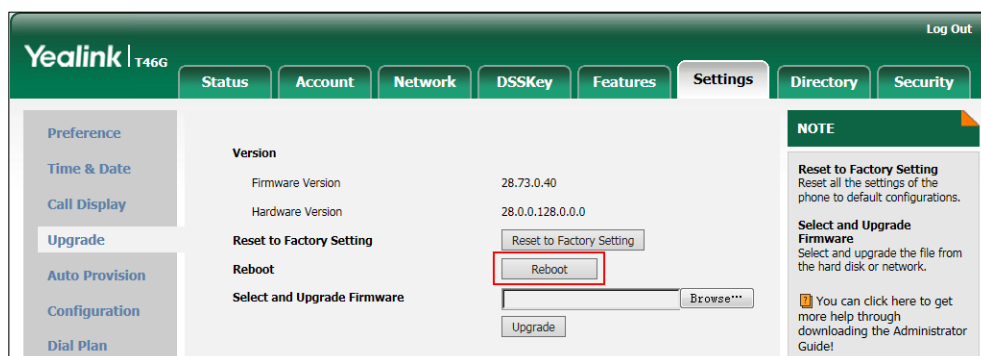

Any reboot of the phone may take a few minutes.

## How to export PCAP trace?

We may need you to provide a PCAP trace to help analyze your problem.

### To export a PCAP trace via web user interface:

1. Click on **Settings->Configuration**.
2. Click **Start** to begin capturing signal traffic.
3. Recreate the error to be documented in the trace.
4. Click **Stop** to stop the capture.
5. Click **Export** to open file download window, and then save the file to your local system.

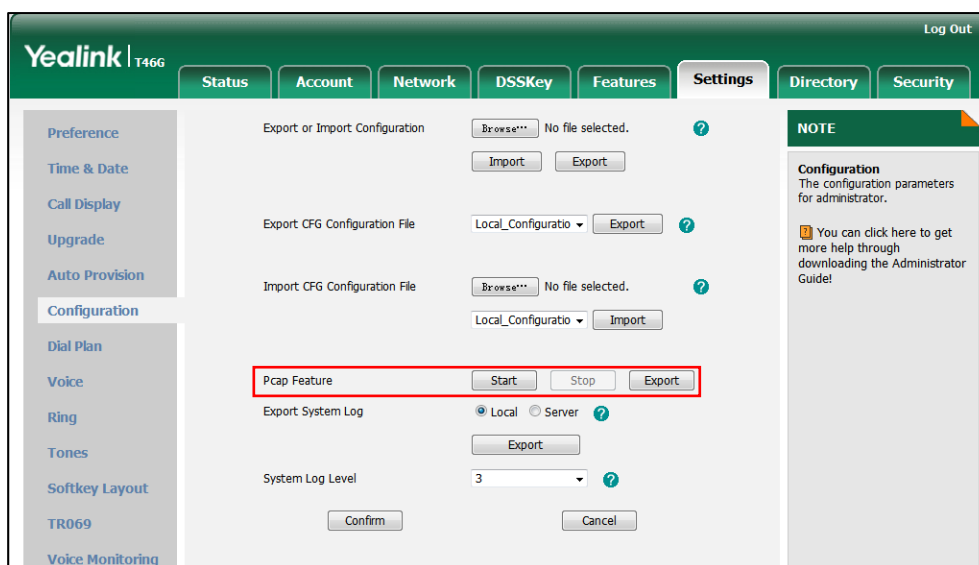

## How to export system log?

We may need you to provide a system log to help analyze your problem.

### To export the system log to a local PC via web user interface:

1. Click on **Settings->Configuration**.
2. Select **6** from the pull-down list of **System Log Level**.
3. Click **Confirm** to accept the change.
4. Mark the **Local** radio box in the **Export System Log** field.

- Click **Export** to open file download window, and then save the file to your local system.

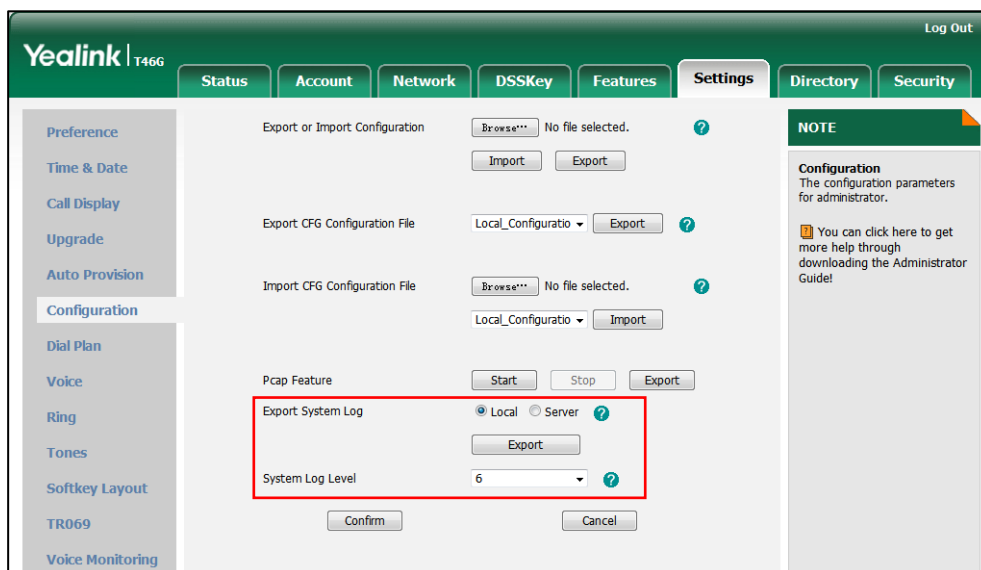

You can also export the system log to a syslog server. Contact your system administrator for more information.

**Note**

It is recommended to reset the syslog level to 3 after exporting the system syslog.

**How to export/import the phone configurations?**

We may need you to provide the phone configurations to help analyze your problem. In some instance, you may need to import configurations to your phone.

**To export the phone configurations via web user interface:**

- Click on **Settings->Configuration**.

- In the **Export or Import Configuration** block, click **Export** to open file download window, and then save the file to your local system.

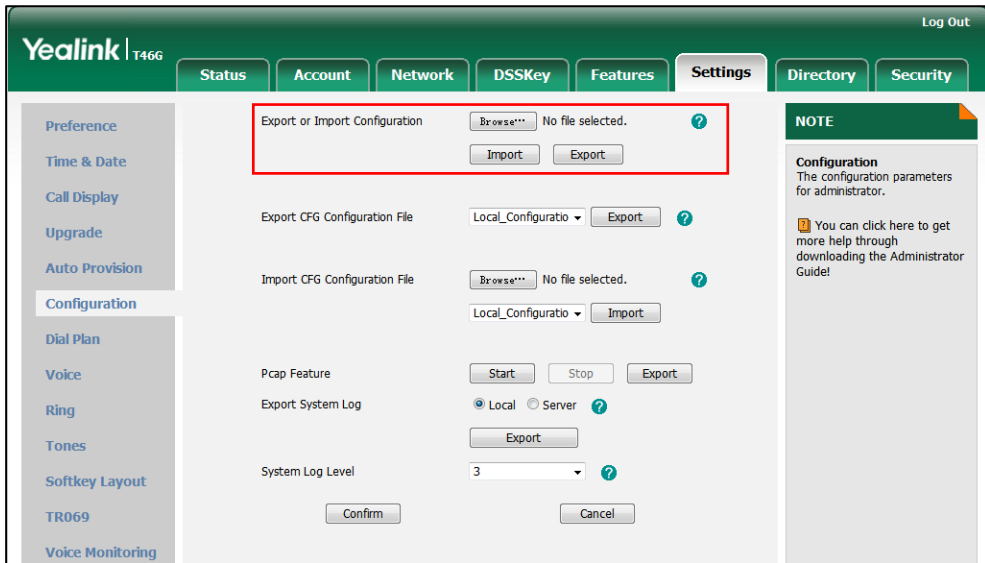

**To import the phone configurations via web user interface:**

- Click on **Settings->Configuration**.
- In the **Export or Import Configuration** block, click **Browse** to locate a configuration file from your local system.
- Click **Import** to import the configuration file.

**Note** The file format of configuration file must be \*.bin.

**How to upgrade firmware?**

**To upgrade firmware via web user interface:**

- Click on **Settings->Upgrade**.
- Click **Browse** to locate the required firmware from your local system.

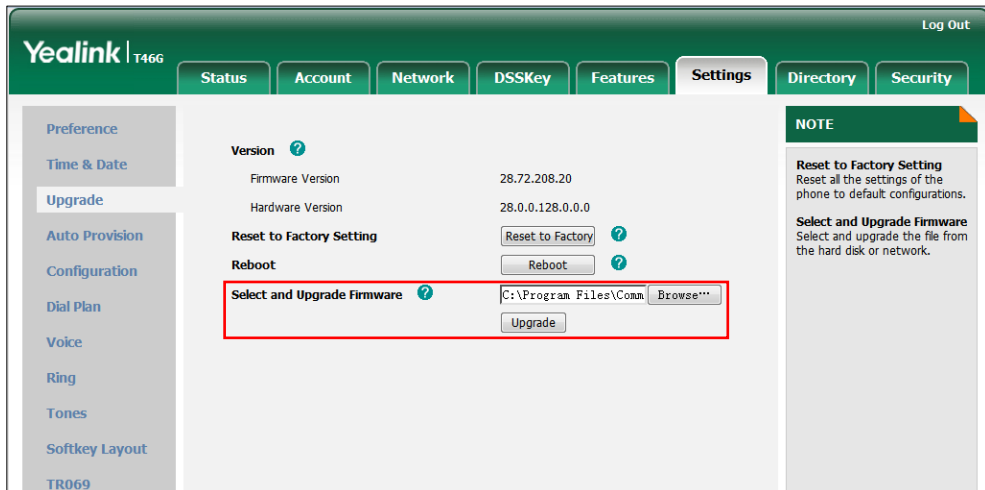



3. Click **Upgrade** to upgrade the firmware.

The browser pops up the dialog box "Firmware of the SIP Phone will be updated. It will take 5 minutes to complete. Please don't power off!".

4. Click **OK** to confirm upgrading.

### How to reset the phone?

Reset the phone to factory configurations after you have tried all troubleshooting suggestions but do not solve the problem.

Three ways to reset the phone:

- **Full Reset:** All configurations and userdata on the phone will be reset.
- **Config Reset:** All configurations (e.g., account, call history) set on the phone will be reset.
- **Userdata Reset:** All custom data (e.g., ring tone) set on the phone will be reset.

Contact your system administrator before resetting the phone.

### To reset the phone via phone user interface:

1. Press **Menu->Advanced** (default password: admin) ->**Reset&Reboot->Reset to Factory**.
2. Press **◀** or **▶** , or the **Switch** soft key to select the desired type from **Reset Option** field.
3. Press the **Save** soft key.

The LCD screen prompts the following warning:



4. Press the **OK** soft key.

The LCD screen prompts “Welcom Initializing...Please wait”.

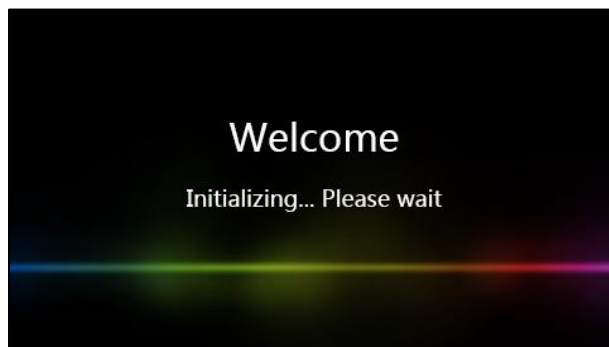

The phone will be reset to factory settings sucessfully after startup.

**Note**

Reset of your phone may take a few minutes. Do not power off until the phone has started up successfully.

## Regulatory Notices

### Service Agreements

Contact your Yealink Authorized Reseller for information about service agreements applicable to your product.

### Limitations of Liability

TO THE FULL EXTENT ALLOWED BY LAW, YEALINK EXCLUDES FOR ITSELF AND ITS SUPPLIERS ANY LIABILITY, WHETHER BASED IN CONTRACT OR TORT (INCLUDING NEGLIGENCE), FOR INCIDENTAL, CONSEQUENTIAL, INDIRECT, SPECIAL, OR PUNITIVE DAMAGES OF ANY KIND, OR FOR LOSS OF REVENUE OR PROFITS, LOSS OF BUSINESS, LOSS OF INFORMATION OR DATA, OR OTHER FINANCIAL LOSS ARISING OUT OF OR IN CONNECTION WITH THE SALE, INSTALLATION, MAINTENANCE, USE, PERFORMANCE, FAILURE, OR INTERRUPTION OF ITS PRODUCTS, EVEN IF YEALINK OR ITS AUTHORIZED RESELLER HAS BEEN ADVISED OF THE POSSIBILITY OF SUCH DAMAGES, AND LIMITS ITS LIABILITY TO REPAIR, REPLACEMENT, OR REFUND OF THE PURCHASE PRICE PAID, AT YEALINK'S OPTION. THIS DISCLAIMER OF LIABILITY FOR DAMAGES WILL NOT BE AFFECTED IF ANY REMEDY PROVIDED HEREIN SHALL FAIL OF ITS ESSENTIAL PURPOSE.

### Safety Instructions

**Save these instructions. Read these safety instructions before use!**

The following basic safety precautions should always be followed to reduce the risk of fire, electrical shock, and other personal injury.

#### General Requirements

- Before you install and use the device, read the safety instructions carefully and observe the situation during operation.
- During the process of storage, transportation, and operation, please always keep the device dry and clean.
- During the process of storage, transportation, and operation, please avoid collision and crash of the device.
- Please do not attempt to dismantle the device by yourself. In case of any discrepancy, please contact the appointed maintenance center for repair.
- Without prior written consent, no organization or individual is permitted to make any change to the structure or the safety design of the device. Yealink is under no circumstances liable to consequences or legal issues caused by such changes.
- Please refer to the relevant laws and statutes while using the device. Legal rights of others should also be respected as well.

#### Environmental Requirements

- Place the device at a well-ventilated place. Do not expose the device under direct sunlight.
- Keep the device dry and free of dust.

- Place the device on a stable and level platform.
- Please do not place heavy objects on the device in case of damage and deformation caused by the heavy load.
- Keep at least 10 cm between the device and the closest object for heat dissipation.
- Do not place the device on or near any inflammable or fire-vulnerable object, such as rubber-made materials.
- Keep the device away from any heat source or bare fire, such as a candle or an electric heater.
- Keep the device away from any household appliance with a strong magnetic field or electromagnetic field, such as a microwave oven or a refrigerator.

### **Operating Requirements**

- Do not let a child operate the device without guidance.
- Do not let a child play with the device or any accessory in case of accidental swallowing.
- Please only use the accessories provided or authorized by the manufacturer.
- The power supply of the device must meet the requirements of the input voltage of the device. Please use the provided surge protection power socket only.
- Before plugging or unplugging any cable, make sure that your hands are completely dry.
- Do not spill liquid of any kind on the product or use the equipment near water, for example, near a bathtub, washbowl, kitchen sink, wet basement or near a swimming pool.
- Do not tread on, pull, or over-bend any cable in case of malfunction of the device.
- During a thunderstorm, stop using the device and disconnect it from the power supply. Unplug the power plug and the Asymmetric Digital Subscriber Line (ADSL) twisted pair (the radio frequency cable) to avoid lightning strike.
- If the device is left unused for a rather long time, disconnect it from the power supply and unplug the power plug.
- When there is smoke emitted from the device, or some abnormal noise or smell, disconnect the device from the power supply, and unplug the power plug immediately. Contact the specified maintenance center for repair.
- Do not insert any object into equipment slots that is not part of the product or auxiliary product.
- Before connecting a cable, connect the grounding cable of the device first. Do not disconnect the grounding cable until you have disconnected all other cables.

### **Cleaning Requirements**

- Before cleaning the device, stop using it and disconnect it from the power supply.
- Use a piece of soft, dry and anti-static cloth to clean the device.
- Keep the power plug clean and dry. Using a dirty or wet power plug may lead to electric shock or other perils.

## Appendix A - Time Zones

Time Zone	Time Zone Name
- 11:00	Samoa
- 10:00	United States-Hawaii-Aleutian
- 09:30	French Polynesia
- 09:00	United States-Alaska Time
- 08:00	Canada(Vancouver, Whitehorse)
- 08:00	Mexico(Tijuana, Mexicali)
- 08:00	United States-Pacific Time
- 07:00	Canada(Edmonton, Calgary)
- 07:00	Mexico(Mazatlan, Chihuahua)
- 07:00	United States-Mountain Time
- 07:00	United States-MST no DST
- 06:00	Canada-Manitoba(Winnipeg)
- 06:00	Chile(Easter Islands)
- 06:00	Mexico(Mexico City, Acapulco)
- 06:00	United States-Central Time
- 05:00	Bahamas(Nassau)
- 05:00	Canada(Montreal, Ottawa, Quebec)
- 05:00	Cuba(Havana)
- 05:00	United States-Eastern Time
- 04:30	Venezuela(Caracas)
- 04:00	Canada(Halifax, Saint John)
- 04:00	Chile(Santiago)
- 04:00	Paraguay(Asuncion)
- 04:00	United Kingdom-Bermuda(Bermuda)
- 04:00	United Kingdom(Falkland Islands)
- 04:00	Trinidad&Tobago
- 03:30	Canada-New Foundland(St.Johns)
- 03:00	Denmark-Greenland(Nuuk)
- 03:00	Argentina(Buenos Aires)
- 03:00	Brazil(no DST)
- 03:00	Brazil(DST)
- 02:30	Newfoundland and Labrador
- 02:00	Brazil(no DST)
- 01:00	Portugal(Azores)
0	GMT
0	Greenland
0	Denmark-Faroe Islands(Torshavn)
0	Ireland(Dublin)
0	Portugal(Lisboa, Porto, Funchal)
0	Spain-Canary Islands(Las Palmas)
0	United Kingdom(London)
0	Morocco
+ 01:00	Albania(Tirane)
+ 01:00	Austria(Vienna)
+ 01:00	Belgium(Brussels)
+ 01:00	Caicos
+ 01:00	Chad
+ 01:00	Spain(Madrid)
+ 01:00	Croatia(Zagreb)
+ 01:00	Czech Republic(Prague)
+ 01:00	Denmark(Kopenhagen)

Time Zone	Time Zone Name
+01:00	France(Paris)
+01:00	Germany(Berlin)
+01:00	Hungary(Budapest)
+01:00	Italy(Rome)
+01:00	Luxembourg(Luxembourg)
+01:00	Macedonia(Skopje)
+01:00	Netherlands(Amsterdam)
+01:00	Namibia(Windhoek)
+02:00	Estonia(Tallinn)
+02:00	Finland(Helsinki)
+02:00	Gaza Strip(Gaza)
+02:00	Greece(Athens)
+02:00	Israel(Tel Aviv)
+02:00	Jordan(Amman)
+02:00	Latvia(Riga)
+02:00	Lebanon(Beirut)
+02:00	Moldova(Kishinev)
+02:00	Russia(Kaliningrad)
+02:00	Romania(Bucharest)
+02:00	Syria(Damascus)
+02:00	Turkey(Ankara)
+02:00	Ukraine(Kyiv, Odessa)
+03:00	East Africa Time
+03:00	Iraq(Baghdad)
+03:00	Russia(Moscow)
+03:30	Iran(Teheran)
+04:00	Armenia(Yerevan)
+04:00	Azerbaijan(Baku)
+04:00	Georgia(Tbilisi)
+04:00	Kazakhstan(Aktau)
+04:00	Russia(Samara)
+04:30	Afghanistan(Kabul)
+05:00	Kazakhstan(Aqtobe)
+05:00	Kyrgyzstan(Bishkek)
+05:00	Pakistan(Islamabad)
+05:00	Russia(Chelyabinsk)
+05:30	India(Calcutta)
+05:45	Nepal(Katmandu)
+06:00	Kazakhstan(Astana, Almaty)
+06:00	Russia(Novosibirsk, Omsk)
+06:30	Myanmar(Naypyitaw)
+07:00	Russia(Krasnoyarsk)
+07:00	Thailand(Bangkok)
+08:00	China(Beijing)
+08:00	Singapore(Singapore)
+08:00	Australia(Perth)
+08:00	Russia(Irkutsk, Ulan-Ude)
+08:45	Eucla
+09:00	Korea(Seoul)
+09:00	Japan(Tokyo)
+09:00	Russia(Yakutsk, Chita)
+09:30	Australia(Adelaide)
+09:30	Australia(Darwin)
+10:00	Australia(Sydney, Melbourne, Canberra)
+10:00	Australia(Brisbane)
+10:00	Australia(Hobart)

---

<b>Time Zone</b>	<b>Time Zone Name</b>
+ 10:00	Russia(Vladivostok)
+ 10:30	Australia(Lord Howe Islands)
+ 11:00	New Caledonia(Noumea)
+ 11:00	Russia(Srednekolymk Time)
+ 11:30	Norfolk Island
+ 12:00	New Zealand(Wellington, Auckland)
+ 12:00	Russia(Kamchatka Time)
+ 12:45	New Zealand(Chatham Islands)
+ 13:00	Tonga(Nukualofa)
+ 13:30	Chatham Islands
+ 14:00	Kiribati





# Index

## A

About This Guide [v](#)  
 Account Management [75](#)  
 Account Registration [75](#)  
 Adding Contacts [39](#)  
 Administrator password [27](#)  
 Anonymous Call [121](#)  
 Anonymous Call Rejection [122](#)  
 Answering Calls [90](#)  
 Area Code [81](#)  
 Attaching Stand [11](#)  
 Audio Settings [31](#)  
 Auto Answer [90](#)  
 Auto Redial [94](#)  
 Automatic Call Distribution [142](#)

## B

Backlight [22](#)  
 Basic Network Settings [16](#)  
 Blacklist [49](#)  
 Block Out [82](#)  
 Bluetooth [57](#)  
 Busy Lamp Field (BLF) [125](#)  
 BLF List [127](#)

## C

Call Completion [95](#)  
 Call Forward [103](#)  
 Call Mute [97](#)  
 Call History Management [53](#)  
 Call Hold/Resume [98](#)  
 Call Park [116](#)  
 Call Pickup [117](#)  
 Call Recording [127](#)  
 Call Transfer [110](#)  
 Call Waiting [112](#)  
 CE Mark Warning [vi](#)  
 Conference [113](#)  
 Contact Management [34](#)  
 Contrast [23](#)  
 Copyright [v](#)  
 Customizing Your Phone [21](#)

## D

Declaration of Conformity [vi](#)  
 Deleting Contacts [43](#)  
 Dial-now [79](#)  
 Dial Plan [77](#)  
 Do Not Disturb (DND) [99](#)  
 Documentation [8](#)  
 DSS Keys [62](#)

## E

Editing Contacts [41](#)  
 Emergency Number [83](#)  
 Ending Calls [91](#)

## G

General Settings [21](#)  
 Getting Started [9](#)

## H

Hardware Component Instructions [1](#)  
 Headset Use [55](#)  
 Headset Mode Activation/Deactivation [55](#)  
 Hotline [85](#)  
 Hot Desking [131](#)

## I

Icon Instructions [3](#)  
 Idle screen [18](#)  
 Importing/Exporting Contact lists [48](#)  
 In This Guide [v](#)  
 Incoming Intercom Calls [134](#)  
 Intercom [133](#)

## K

Key as Send [27](#)

## L

Language [24](#)  
 LED Instructions [4](#)  
 Limitation of Liability [163](#)  
 Line Keys [62](#)  
 Live Dialpad [84](#)  
 Local Conference [113](#)  
 Local Directory [36](#)

## M

Message Waiting Indicator [149](#)  
 Messages [144](#)  
 Multicast Paging [136](#)  
 Multiple Line Keys per Account [77](#)  
 Music on Hold [141](#)

## N

Network Conference [114](#)  
 Network Connection [11](#)

## P

Packaging Contents [9](#)  
 Phone Initialization [14](#)

Phone Installation	11
Phone Status	15
Phone User Interface	6
Phone Lock	28
Placing Calls	87
Placing Calls to Contacts	45
Programmable Keys	73

## O

Outgoing Intercom Calls	133
Overview	1
Optional Accessories	10

## R

Recent Call In Dialing	92
Redialing Numbers	92
Registration	18
Regulatory Notices	163
Remote Phone Book	51
Replace Rule	78
Recall	97
Ring Tones	32

## S

Safety Instructions	163
Search Source List in Dialing	46
Searching for Contacts	45
Semi-attended Transfer	110
Service Agreements	163
Short Message Service (SMS)	144
System Customizations	55

## T

Time & Date	25
Time Zones	165
Troubleshooting	153

## V

Voice Mail	147
Volume	31

## W

Warranty	vi
Wallpaper	21
Web User Interface	6
WEEE Warning	vii