



## Ultra-elegant Gigabit IP Phone SIP-T48G User Guide

# Copyright

**Copyright © 2014 YEALINK NETWORK TECHNOLOGY CO., LTD.**

Copyright © 2014 Yealink Network Technology CO., LTD. All rights reserved. No parts of this publication may be reproduced or transmitted in any form or by any means, electronic or mechanical, photocopying, recording, or otherwise, for any purpose, without the express written permission of Yealink Network Technology CO., LTD. Under the law, reproducing includes translating into another language or format.

When this publication is made available on media, Yealink Network Technology CO., LTD. gives its consent to downloading and printing copies of the content provided in this file only for private use but not for redistribution. No parts of this publication may be subject to alteration, modification or commercial use. Yealink Network Technology CO., LTD. will not be liable for any damages arising from use of an illegally modified or altered publication.

## Warranty

THE SPECIFICATIONS AND INFORMATION REGARDING THE PRODUCTS IN THIS GUIDE ARE SUBJECT TO CHANGE WITHOUT NOTICE. ALL STATEMENTS, INFORMATION, AND RECOMMENDATIONS IN THIS GUIDE ARE BELIEVED TO BE ACCURATE AND PRESENTED WITHOUT WARRANTY OF ANY KIND, EXPRESS OR IMPLIED. USERS MUST TAKE FULL RESPONSIBILITY FOR THEIR APPLICATION OF PRODUCTS.

YEALINK NETWORK TECHNOLOGY CO., LTD. MAKES NO WARRANTY OF ANY KIND WITH REGARD TO THIS GUIDE, INCLUDING, BUT NOT LIMITED TO, THE IMPLIED WARRANTIES OF MERCHANTABILITY AND FITNESS FOR A PARTICULAR PURPOSE. Yealink Network Technology CO., LTD. shall not be liable for errors contained herein nor for incidental or consequential damages in connection with the furnishing, performance, or use of this guide.

## Declaration of Conformity



Hereby, Yealink Network Technology CO., LTD. declares that this phone is in conformity with the essential requirements and other relevant provisions of the CE, FCC.

## CE Mark Warning

This device is marked with the CE mark in compliance with EC Directives 2006/95/EC and 2004/108/EC.

## Part 15 FCC Rules

This device is compliant with Part 15 of the FCC Rules. Operation is subject to the following two conditions:

1. This device may not cause harmful interference.
2. This device must accept any interference received, including interference that may cause undesired operation.

## Class B Digital Device or Peripheral

Note: This equipment has been tested and found to comply with the limits for a Class B digital device, pursuant to part 15 of the FCC Rules. These limits are designed to provide reasonable protection against harmful interference in a residential installation. This equipment generates, uses and can radiate radio frequency energy and, if not installed and used in accordance with the instructions, may cause harmful interference to radio communications. However, there is no guarantee that interference will not occur in a particular installation. If this equipment does cause harmful interference to radio or television reception, which can be determined by turning the equipment off and on, the user is encouraged to try to correct the interference by one or more of the following measures:

1. Reorient or relocate the receiving antenna.
2. Increase the separation between the equipment and receiver.
3. Connect the equipment into an outlet on a circuit different from that to which the receiver is connected.
4. Consult the dealer or an experienced radio/TV technician for help.

## WEEE Warning



To avoid the potential effects on the environment and human health as a result of the presence of hazardous substances in electrical and electronic equipment, end users of electrical and electronic equipment should understand the meaning of the crossed-out wheeled bin symbol. Do not dispose of WEEE as unsorted municipal waste and have to collect such WEEE separately.

## Customer Feedback

We are striving to improve our documentation quality and we appreciate your feedback. Email your opinions and comments to [DocsFeedback@yealink.com](mailto:DocsFeedback@yealink.com).

# GNU GPL INFORMATION

Yealink SIP-T48G IP phone firmware contains third-party software under the GNU General Public License (GPL). Yealink uses software under the specific terms of the GPL. Please refer to the GPL for the exact terms and conditions of the license.

The original GPL license, source code of components licensed under GPL and used in Yealink products can be downloaded online:

<http://www.yealink.com/GPLOpenSource.aspx?BaseInfoCatId=293&NewsCatId=293&CatId=293>.

## About This Guide

Thank you for choosing the SIP-T48G IP phone, an ultra-elegant gigabit IP phone which is exquisitely designed to provide business telephony features, such as Call Hold, Call Transfer, Busy Lamp Field, Call Recording, Multicast Paging and Conference over an IP network. It also features an enhanced user experience and newly developed industrial designs, with a large touch screen for easy and efficient use.

This guide provides everything you need to quickly use your new phone. First, verify with your system administrator that the IP network is ready for phone configuration. Also be sure to read the Packaging Contents and Regulatory Notices sections in this guide before you set up and use the SIP-T48G IP phone.

**Note**

Shared Line, Network Directory and Network Call Log features are hidden for IP phones in neutral firmware, which are designed for the BroadWorks environment. Please contact your system administrator for more information.

## In This Guide

Topics provided in this guide include:

- Chapter 1 [Overview](#)
- Chapter 2 [Getting Started](#)
- Chapter 3 [Customizing Your Phone](#)
- Chapter 4 [Basic Call Features](#)
- Chapter 5 [Advanced Phone Features](#)

## Summary of Changes

This section describes the changes to this guide for each release and guide version.

### Changes for Release 73, Guide Version 73.40

The following section is new:

- [Optional Accessories](#) on page 10

Major updates have occurred to the following sections:

- [DSS Keys](#) on page 74

- [Appendix A - Time Zones](#) on page 175

## Changes for Release 73, Guide Version 73.16

The following sections are new:

- [BLF List](#) on page 140

Major updates have occurred to the following sections:

- [LED Instructions](#) on page 4
- [Ring Tones](#) on page 34
- [Anonymous Call Rejection](#) on page 135
- [Multicast Paging](#) on page 149
- [Troubleshooting](#) on page 163
- [Appendix A - Time Zones](#) on page 175

## Changes for Release 72, Guide Version 72.10

Major updates have occurred to the following sections:

- [Documentations](#) on page 7
- [Packaging Contents](#) on page 9
- [Phone Installation](#) on page 12
- [Contact Management](#) on page 36
- [Placing Calls](#) on page 98

# Table of Contents

<b>About This Guide .....</b>	<b>v</b>
In This Guide .....	v
Summary of Changes.....	v
Changes for Release 73, Guide Version 73.40 .....	v
Changes for Release 73, Guide Version 73.16 .....	vi
Changes for Release 72, Guide Version 72.10 .....	vi
<b>Table of Contents.....</b>	<b>vii</b>
<b>Overview .....</b>	<b>1</b>
Hardware Component Instructions.....	1
Icon Instructions .....	3
LED Instructions .....	4
User Interfaces.....	5
Phone User Interface .....	5
Web User Interface.....	5
Documentations.....	7
<b>Getting Started.....</b>	<b>9</b>
Packaging Contents.....	9
Optional Accessories.....	10
Phone Installation.....	12
Phone Initialization.....	14
Registration .....	15
Touch Screen Display.....	15
Navigating Menus and Fields.....	17
Entering Data and Editing Fields .....	18
Phone Status.....	19
Basic Network Settings.....	21
<b>Customizing Your Phone .....</b>	<b>25</b>
General Settings.....	25
Wallpaper .....	25
Backlight.....	27
Contrast.....	27

Language .....	28
Time & Date .....	29
Administrator Password .....	32
Key as Send .....	33
Audio Settings .....	33
Volume .....	33
Ring Tones .....	34
Contact Management .....	36
Directory .....	37
Local Directory .....	38
Blacklist .....	56
Remote Phone Book .....	58
Call History Management .....	61
System Customizations .....	65
Headset Use .....	65
Bluetooth Headset .....	67
DSS Keys .....	74
Account Management .....	84
Dial Plan .....	87
Live Dialpad .....	93
Hotline .....	94
<b>Basic Call Features .....</b>	<b>97</b>
Placing Calls .....	98
Answering Calls .....	100
Ending Calls .....	102
Redialing Numbers .....	102
Recent Call In Dialing .....	102
Auto Answer .....	104
Auto Redial .....	105
Call Completion .....	106
Recall .....	108
Call Mute .....	109
Call Hold/Resume .....	110
Do Not Disturb (DND) .....	110
Call Forward .....	115
Call Transfer .....	123
Call Waiting .....	125
Conference .....	126
Local Conference .....	126
Network Conference .....	127
Call Park .....	129
Call Pickup .....	130
Anonymous Call .....	134



---

Anonymous Call Rejection.....	135
<b>Advanced Phone Features.....</b>	<b>137</b>
Busy Lamp Field (BLF).....	137
BLF List .....	140
Call Recording.....	142
Hot Desking.....	144
Intercom .....	146
Outgoing Intercom Calls .....	147
Incoming Intercom Calls.....	147
Multicast Paging .....	149
Sending RTP Stream .....	149
Receiving RTP Stream.....	154
Music on Hold .....	155
Automatic Call Distribution (ACD) .....	156
Messages.....	158
Voice Mail.....	158
Message Waiting Indicator (MWI) .....	160
<b>Troubleshooting .....</b>	<b>163</b>
<b>Regulatory Notices .....</b>	<b>173</b>
Service Agreements .....	173
Limitations of Liability .....	173
Safety Instructions.....	173
<b>Appendix A - Time Zones.....</b>	<b>175</b>
<b>Index.....</b>	<b>179</b>



# Overview

This chapter provides the overview of the SIP-T48G IP phone. Topics include:

- [Hardware Component Instructions](#)
- [Icon Instructions](#)
- [LED Instructions](#)
- [User Interfaces](#)
- [Documentations](#)



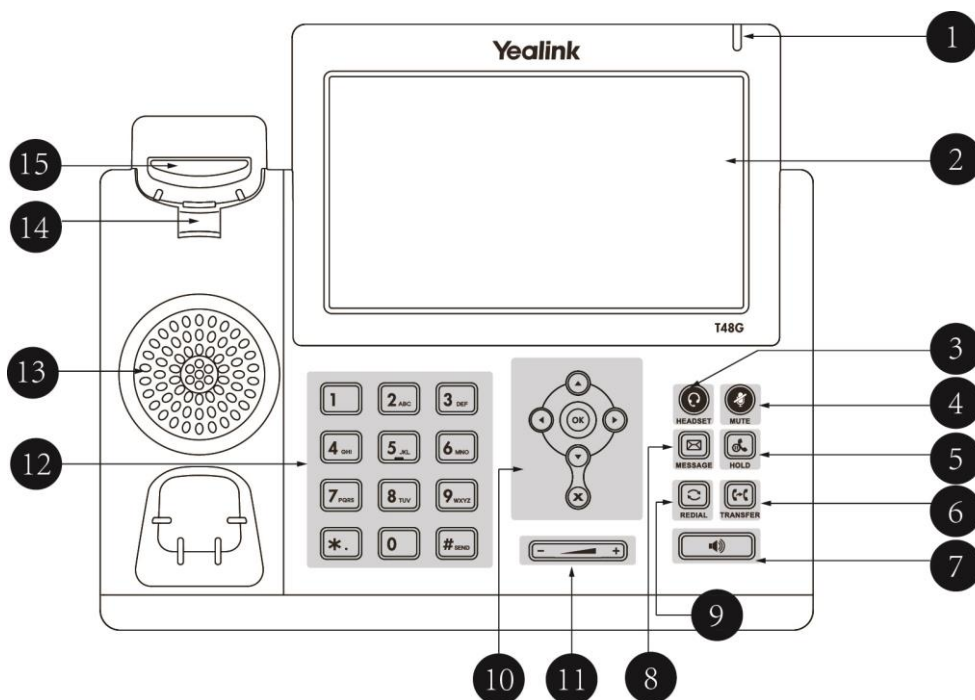

If you require additional information or assistance with your new phone, contact your system administrator.

## Hardware Component Instructions

The main hardware components of the SIP-T48G IP phone are the touch screen and the keypad.

































Hardware component instructions of the SIP-T48G IP phone are:

	Item	Description
①	Power Indicator LED	Indicates phone power and some feature statuses.
②	Touch Screen	The screen is touch-sensitive. Tap to select and highlight screen items. Shows information about calls, messages, soft keys, time, date and other relevant data: <ul style="list-style-type: none"> <li>• Call information—caller ID, call duration</li> <li>• Icons (for example, )</li> <li>• Missed call text or second incoming caller information</li> <li>• Prompt text (for example, "Saving config file! ")</li> <li>• Time and date</li> </ul>
③	HEADSET Key	Toggles and indicates the headset mode.
④	MUTE Key	Toggles and indicates mute feature.
⑤	HOLD Key	Places a call on hold or resumes a held call.
⑥	TRANSFER Key	Transfers a call to another party.
⑦	Speakerphone Key	Toggles the hands-free speakerphone mode.
⑧	MESSAGE Key	Accesses voice messages.
⑨	REDIAL Key	Redials a previously dialed number.
⑩		Position the cursor within text you're updating. Enable or disable fields.
		Turn pages or scroll through values for a field. Scroll through items. Access to History and Directory respectively.
		Confirms actions or answers incoming calls.
		Cancels actions or rejects incoming calls.
⑪	Volume Key	Adjusts the volume of the handset, headset, speakerphone and ringer.
⑫	Keypad	Provides the digits, letters and special characters in context-sensitive applications.
⑬	Speaker	Provides ringer and hands-free (speakerphone) audio output.
⑭	Hookswitch Tab	Secures the handset in the handset cradle when the IP phone is mounted vertically. For more information on how to adjust the hookswitch tab, refer to <i>Yealink Wall Mount Quick Installation Guide for T4X IP Phones</i> .
⑮	Hookswitch	Picking up the handset from the handset cradle, the hookswitch bounces and the phone connects to the line, laying the handset down on the handset cradle, the phone disconnects from the line.

## Icon Instructions

Icons appearing on the touch screen are described in the following table:

Icons	Description
	Network is unavailable
	Registered successfully
	Register failed
 (Flashing)	Registering
	Hands-free speakerphone mode
	Handset mode
	Headset mode
	Multi-lingual lowercase letters input mode
	Multi-lingual uppercase letters input mode
	Alphanumeric input mode
	Numeric input mode
	Multi-lingual uppercase and lowercase letters input mode
	Voice Mail
	Auto Answer
	Do Not Disturb
	Call Forward
	Call Hold
	Call Mute
	Ringer volume is 0

Icons	Description
	Received Calls
	Placed Calls
	Missed Calls
	Forwarded Calls
	Recording box is full
	A call cannot be recorded
	Recording starts successfully
	Recording cannot be started
	Recording cannot be stopped
	Bluetooth mode is on
	Bluetooth headset is both paired and connected
	The default caller photo and contact icon

## LED Instructions

### Power Indicator LED

LED Status	Description
Solid red	The phone is initializing.
Fast flashing red	The phone is ringing.
Slow flashing red	The phone receives a voice mail.
Off	<p>The phone is powered off.</p> <p>The phone is idle.</p> <p>The phone is busy.</p> <p>The call is placed on hold or is held.</p> <p>The call is muted.</p>

#### Note

The above introduces the default power indicator LED status. The status of the power indicator LED is configurable via web user interface. For more information, refer to *Yealink SIP-T4X IP Phones Administrator Guide*.

## User Interfaces

Two ways to customize configurations of your SIP-T48G IP phone:

- The user interface on the IP phone.
- The user interface in a web browser on your PC.

The hardware components keypad and touch screen constitute the phone user interface, which allows the user to execute all call operation tasks and basic configuration changes directly on the phone. In addition, you can use the web user interface to access all configuration settings. In many cases, it is possible to use either the phone user interface and/or the web user interface interchangeably. However, in some cases, it is only possible to use one or the other interface to operate the phone and change settings.

## Phone User Interface

You can customize your phone by tapping the Menu soft key to access the phone user interface. The Advanced option is only accessible to the administrator, and the default administrator password is “admin” (case-sensitive). For more information on customizing your phone with the available options from the phone user interface, refer to [Customizing Your Phone](#) on page 25.

## Web User Interface

In addition to the phone user interface, you can also customize your phone via web user interface. In order to access the web user interface, you need to know the IP address of your new phone. To obtain the IP address, press the OK key on the phone when the phone is idle. Enter the IP address (e.g., <http://192.168.0.10> or 192.168.0.10) in the address bar of a web browser on your PC. The default administrator user name and password are both “admin” (case-sensitive).

The main options you can use to customize the IP phone via phone user interface and/or via web user interface are listed in the following table:

Options	Phone User Interface	Web User Interface
<b>Status</b>		
--IP Address		
--MAC		
--Firmware	√	√
--Network		
--Phone		
--Accounts		
<b>Basic Phone Settings</b>		√

Options	Phone User Interface	Web User Interface
--Wallpaper	√	
--Backlight	√	
--Contrast	√	
--Language	√	
--Time & Date	√	
--Administrator Password	√	
--Key as Send	√	
--Ring Tones	√	
--Contact Management	x	
--Directory	x	
--Local Directory	√	
--Blacklist	√	
--Remote Phone Book	x	
--Call History Management	√	
--DSS Keys	√	
--Account Registration	√	
--Dial Plan	x	
--Emergency Number	x	
--Live Dialpad	x	
--Hotline	√	
<b>Basic Call Features</b>		
--Recent Call In Dialing	x	
--Auto Answer	√	
--Auto Redial	√	
--Call Completion	√	
--ReCall	√	
--Do Not Disturb (DND)	√	
--Call Forward	√	√
--Call Transfer	√	
--Call Waiting	√	
--Conference	x	
--Call Park	√	
--Call Pickup	√	
--Anonymous Call	√	
--Anonymous Call Rejection	√	
<b>Advanced Phone Features</b>		
--Busy Lamp Field (BLF)	√	
--BLF List	x	
--Call Recording	√	√
--Hot Desking	√	
--Intercom	√	



Options	Phone User Interface	Web User Interface
--Multicast Paging	x	
--Music on Hold	x	
--ACD	x	
--Messages	√	
<b>SIP Account</b>		
--User Options	x	
--Activation	√	
--Label	√	
--Display Name	√	
--Register Name	√	
--User Name	√	√
--Password	√	
--SIP Server1/2	√	
--Server Option	x	
--Registrar Port	x	
--Outbound Status	√	
--Outbound Proxy	√	
--NAT Status	√	

**Note**

The table above lists most of the feature options. Please refer to the relevant sections for more information.

## Documentations

The following table shows documentations available for the SIP-T48G IP phone.

Name	Contents	Where found	Language
Quick Start Guide	Basic call features and phone customizations	In the package	English
User Guide	Phone/Web user interface settings Basic call features and advanced phone features	On the website	English

**Note**

You can also download the latest documentations online:  
<http://www.yealink.com/DocumentDownload.aspx?CatId=142&flag=142>.



# Getting Started

This chapter provides the following basic installation instructions and information for obtaining the best performance with the SIP-T48G IP phone. Topics include:

- [Packaging Contents](#)
- [Phone Installation](#)
- [Phone Initialization](#)
- [Registration](#)
- [Touch Screen Display](#)
- [Navigating Menus and Fields](#)
- [Entering Data and Editing Fields](#)
- [Phone Status](#)
- [Basic Network Settings](#)

If you require additional information or assistance with your new phone, contact your system administrator.

## Packaging Contents

The following components are included in your SIP-T48G IP phone package:

- **SIP-T48G IP Phone**

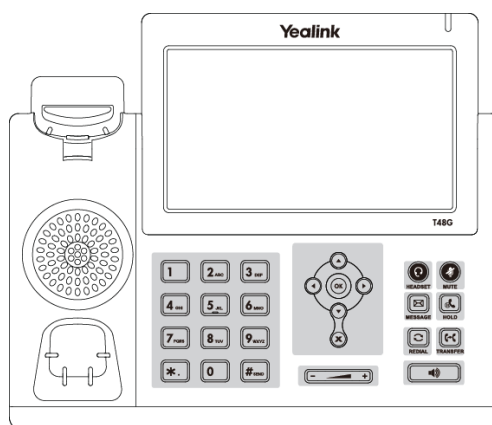

- **Phone Stand**

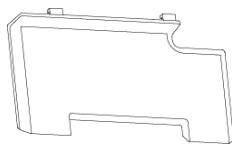

- **Handset & Handset Cord**

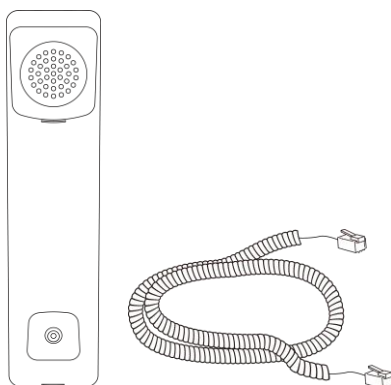

- **Ethernet Cable**

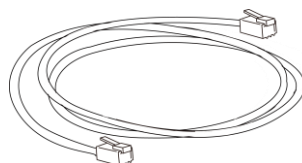

- **Quick Start Guide**

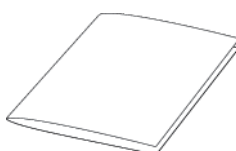

Check the list before installation. If you find anything missing, contact your system administrator.

## Optional Accessories

The following items are optional accessories for your SIP-T48G IP phone. You need to purchase them separately if required.

- Wall Mount Bracket

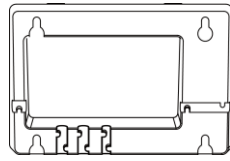

- Power Adapter

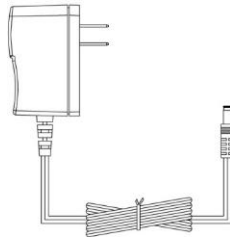

- Headset



- Wireless Headset Adapter EHS36



- Bluetooth USB Dongle BT40



## Phone Installation

If your phone is already installed, proceed to [Phone Initialization](#) on page 14.

This section introduces how to install the phone:

- 1) Attach the stand or the optional wall mount bracket
- 2) Connect the handset and optional headset
- 3) Connect the network and power

### 1) Attach the stand or the optional wall mount bracket

#### Desk Mount Method

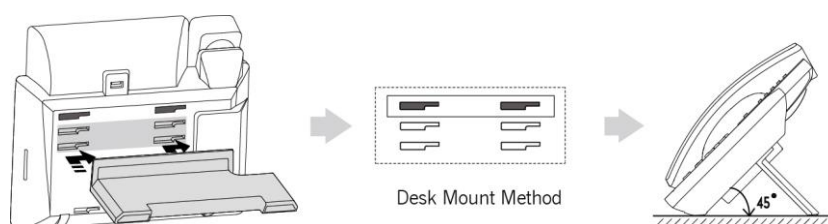

#### Wall Mount Method (Optional)

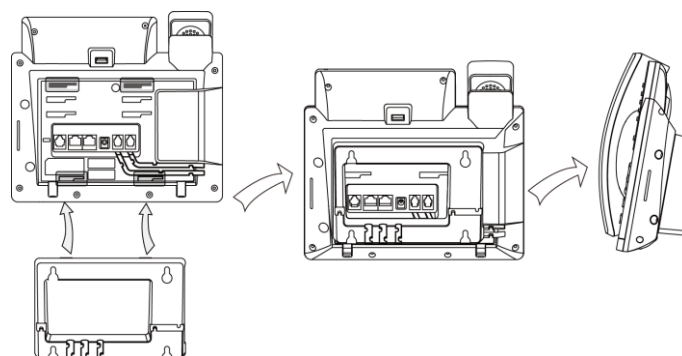

#### Note

The wall mount bracket should be purchased separately.

The top two slots are plugged up by silica gel. You need to pull out silica gel before attaching the wall mount bracket. For more information on how to mount your phone to a wall, refer to *Yealink Wall Mount Quick Installation Guide for T4X IP Phones*.

## 2) Connect the handset and optional headset

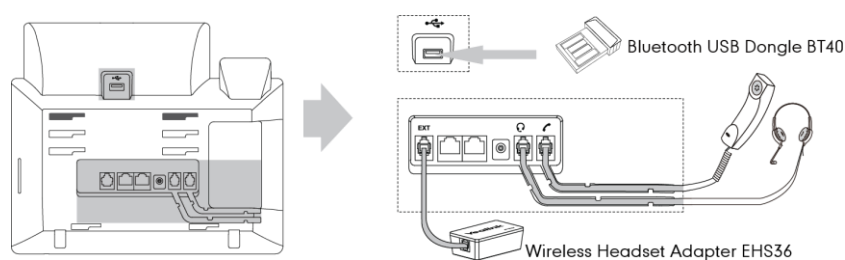

### Note

The headset, wireless headset adapter EHS36 and Bluetooth USB Dongle BT40 should be purchased separately.

The EXT port can also be used to connect an expansion module EXP40.

For more information on how to use the EHS36, EXP40 and Bluetooth USB Dongle BT40, refer to Yealink EHS36 User Guide, Yealink EXP40 User Guide and Yealink Bluetooth USB Dongle BT40 User Guide.

## 3) Connect the network and power

You have two options for power and network connections. Your system administrator will advise you which one to use.

- AC power (Optional)
- Power over Ethernet (PoE)

### AC Power (Optional)

To connect the AC power:

1. Connect the DC plug on the power adapter to the DC5V port on the phone and connect the other end of the power adapter into an electrical power outlet.
2. Connect the included or a standard Ethernet cable between the Internet port on the phone and the one on the wall or switch/hub device port.

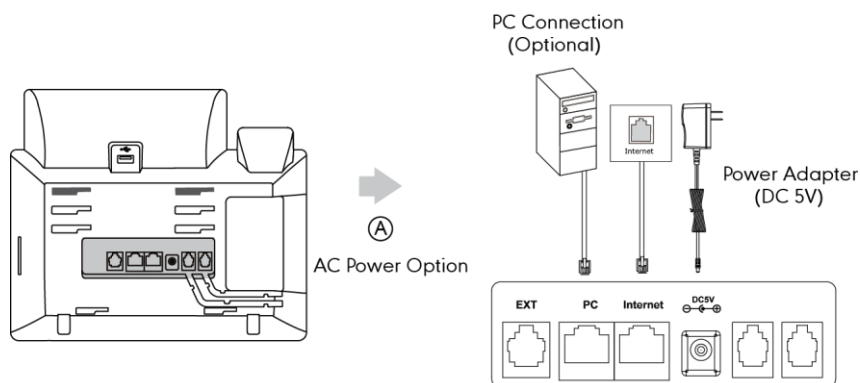

## Power over Ethernet

With the included or a regular Ethernet cable, the SIP-T48G IP phone can be powered from a PoE-compliant switch or hub.

### To connect the PoE:

1. Connect the Ethernet cable between the Internet port on the phone and an available port on the in-line power switch/hub.

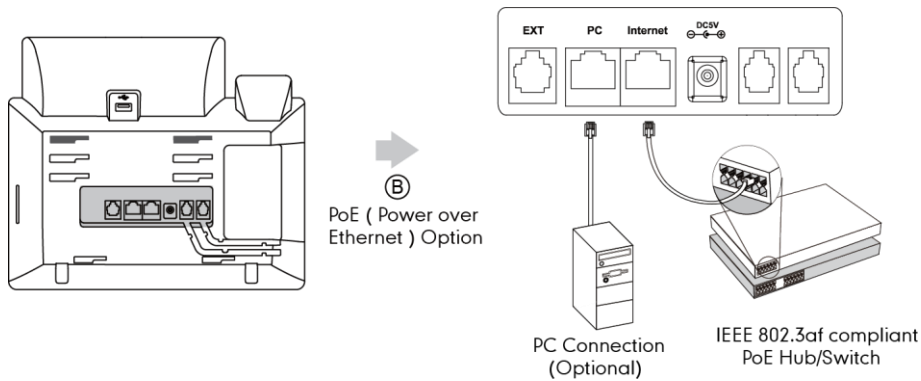

### Note

If in-line power is provided, you don't need to connect the phone to the power adapter. Make sure the switch/hub is PoE-compliant.

The phone can also share the network with another network device such as a PC (personal computer). This is an optional connection.

**Important!** Do not remove power to the phone while it is updating firmware and configurations.

## Phone Initialization

After your phone is powered on, the system boots up and performs the following steps:

### Automatic Phone Initialization

The phone finishes the initialization by loading the saved configuration. The touch screen displays "Initializing...Please wait" during the initialization.

### DHCP (Dynamic Host Configuration Protocol)

The phone attempts to contact a DHCP server in your network to obtain valid IPv4 network settings (e.g., IP address, subnet mask, default gateway address and DNS address) by default.

### Note

If your network does not use DHCP, proceed to [Basic Network Settings](#) on page 21.



## Registration

Generally, your phone will be deployed with multiple other phones. In this case, your system administrator will configure the phone parameters beforehand, so that after you start up your phone, the phone will be registered and ready for use. The SIP-T48G IP phone supports up to 16 accounts. If your phone is not registered, you may have to register it. For more information on how to register your phone, refer to [Account Management](#) on page 84.



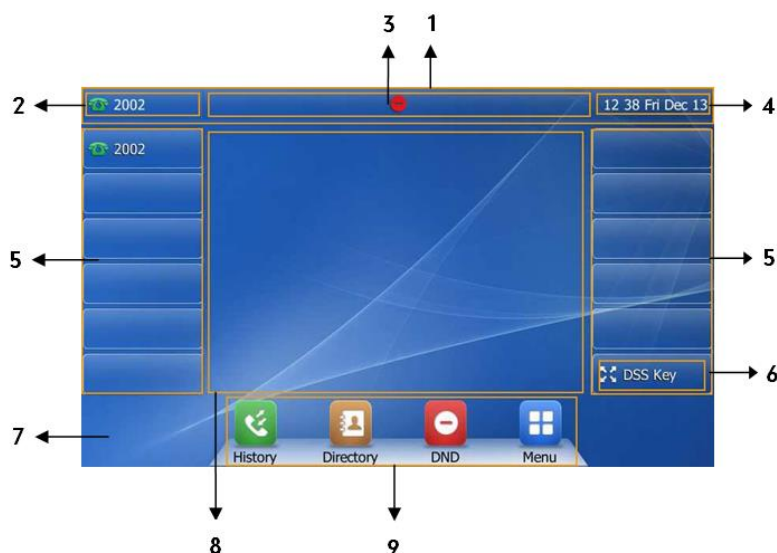

## Touch Screen Display

### Idle Screen Display

If the phone has successfully started up, the idle screen will be displayed. The following figure is an example of what is displayed on the touch screen.



No.	Name	Description
1	Status Bar	Displays the phone's default account, icons and the time and date.
2	Default Account	The label of the default account is displayed on the left of the status bar. If multiple accounts are already registered, tap and select the desired default account. For more information, refer to <a href="#">the default account</a> on page 85.
3	Icons	Icons are displayed in the middle of the status bar.
4	Time and Date	The phone's time and date are displayed on the right of the status bar.

No.	Name	Description
5	Line Keys (1-11)	<p>The idle screen displays line keys 1-11. The line keys 1-6 on the left can be used to activate up to six lines.</p> <p>Various features can be assigned to line keys. Each line key can display the label and indicate the status of the assigned feature.</p>
6	DSS Key	<p>Provides a quick access to the line key screen. Then, you can tap the desired line key to configure it.</p>
7	Wallpaper	<p>Shows the specified wallpaper, which can be customized. For more information, refer to <a href="#">Wallpaper</a> on page 25.</p>
8	Call Window	<p>Displays call information.</p>
9	Shortcut Keys	<p> : tap this shortcut key to enter the History screen and view call history.</p> <p> : tap this shortcut key to enter the Directory screen and view contacts.</p> <p> : tap this shortcut key to toggle the DND mode or enter the custom DND configuration screen.</p> <p> : tap this shortcut key to enter the main menu.</p>

## Configuration Screen Display



No.	Name	Description
1	Screen Title Area	Displays the title of the current menu screen.
2	Operation Option Area	Displays various operation options for different menu screens.
3	Menu Tree Area	Displays menu items. Tap the desired menu item to enter the corresponding feature configuration screen.
4	Configuration Area	Displays configuration items of the highlighted menu item in the menu tree area. You can configure feature settings in this area.
5	Soft Keys	Label automatically to identify their context-sensitive features.

## Navigating Menus and Fields















To navigate menus and fields, you can:

- Tap soft keys on the touch screen.
- Tap menu items, fields, and arrows on the touch screen.
- Press keys on the phone keypad.

### Note

The menu system will automatically exit to the idle screen after 60 seconds of inactivity.

To operate your phone, follow these tips:

If you want to	Action
Enter the main menu.	Tap  .
Return to the idle screen.	Tap  .
Go back to the previous menu.	Tap  or press  .
Select an item.	Tap the item. Scroll to the item by pressing  or  .
Scroll through items page by page.	Tap  or  . (If you are in the call history, local directory, language configuration screen or ring tones configuration screen, you can also press  or  .)
Scroll through values for a field.	Tap the field's highlighted gray box. From the pull-down list, tap  or  to scroll through values page by page, or press  or  to scroll values one by one.
Select a value for a field.	From the pull-down list, tap the value or scroll to the value and then press  .











## Entering Data and Editing Fields

You can enter data and edit fields using the keypad on the phone:

### To enter or edit data:

1. Tap the field.
2. Do one of the following:

If you want to	Action
Enter only digits (1), uppercase (A) characters, lowercase (a) characters, or alphanumeric (2aB) characters.	<p>Press a keypad key one or more times (depending what input mode you're in) to enter the characters that is displayed on the keypad key.</p> <p>You can tap the <b>IME</b> soft key one or more times to switch between uppercase (<b>ABC</b> soft key), numeric (<b>123</b> soft key), alphanumeric (<b>2aB</b> soft key) and lowercase (<b>abc</b> soft key) input modes.</p> <p>For example, if the input mode is <b>ABC</b>:</p> <p>- To enter "A", press  once.</p>

If you want to	Action
	<ul style="list-style-type: none"> <li>- To enter "B", press  twice quickly.</li> <li>- To enter "C", press  three times quickly.</li> </ul>
Enter special characters.	<p>Press the keypad key ,  or .</p> <p>For  key:</p> <p>If it is the uppercase (<b>ABC</b> soft key) or lowercase (<b>abc</b> soft key) input mode, it will provide the space character.</p> <p>If it is the numeric (<b>123</b> soft key) or alphanumeric (<b>2aB</b> soft key) input mode, it will only provide the digit 0.</p> <p>For  key: it only provides the pound character (#).</p> <p>For  key:</p> <p>If it is the uppercase (<b>ABC</b> soft key), lowercase (<b>abc</b> soft key) or alphanumeric (<b>2aB</b> soft key) input mode, it will provide the following special characters: . * : / @ + - \$ [ ]</p> <p>If it is the numeric (<b>123</b> soft key) input mode, it will only provide the asterisk character (*).</p>
Delete text you entered.	Press  or  to position the cursor to the right of the text you want to delete, and then tap the <b>Delete</b> soft key.
Delete an entire field of data.	Swipe your finger to the left or right to select the entire field of data, so that the data is highlighted, and then tap the <b>Delete</b> soft key.

3. Press  or tap the **Save** soft key.

### Note

When the phone is in the pre-dialing screen, characters can be entered using the on-screen keypad.

## Phone Status

You can view phone status via phone user interface or web user interface.

Available information of phone status includes:



- General information (IP address, MAC address and firmware version)
- Network status (e.g., IPv4 status, IPv6 status, IP address mode and MAC address)

- Phone status (e.g., device model, hardware version, product ID and device certificate status)
- Account status (e.g., register status of SIP accounts)

**Note**

You can view the device certificate status via phone user interface only.

**To view the phone status via phone user interface:**

1. Press  , or tap  -> **Status**.



2. Tap the desired item to view the specific information.

**To view the phone status via web user interface:**

1. Open a web browser on your computer.
2. Enter the IP address in the browser's address bar, and then press the **Enter** key.
3. Enter the user name (admin) and password (admin) in the login page.

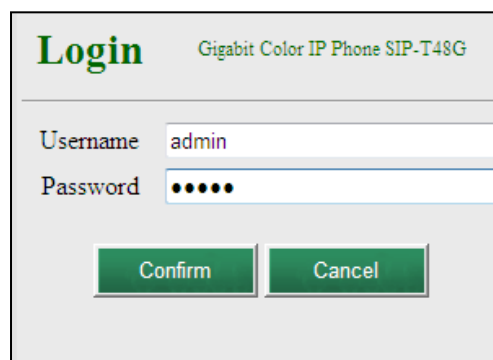

- Click **Confirm** to login.

The phone status is displayed on the first page of the web user interface.

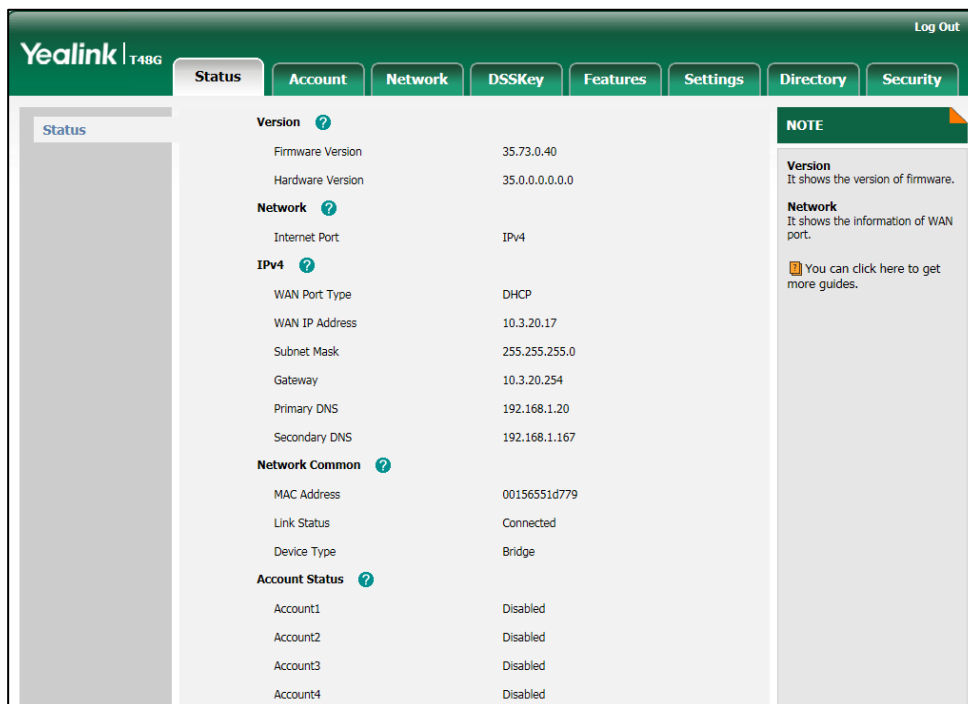

## Basic Network Settings

If your phone cannot contact a DHCP server for any reason, you need to configure network settings manually. The IP phone can support either or both IPv4 and IPv6 addresses.

To configure the IP address mode via phone user interface:

- Tap  -> **Advanced** (default password: admin) -> **Network**-> **WAN Port**.
- Tap the gray box of the **IP Mode** field.
- Tap the desired value (IPv4, IPv6 or IPv4 & IPv6) from the pull-down list.

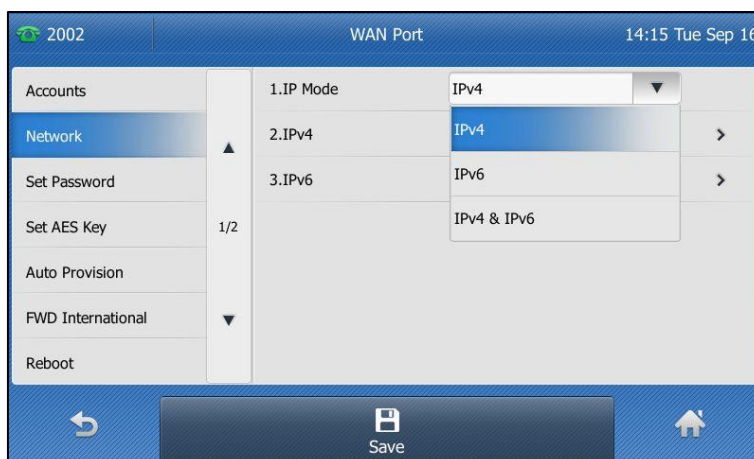

4. Tap the **Save** soft key to accept the change or ↶ to cancel.

**To configure a static IPv4 address via phone user interface:**

1. Tap  -> **Advanced** (default password: admin) -> **Network**->**WAN Port**->**IPv4**.
2. Tap the gray box of the **Type** field.
3. Tap **Static IP** from the pull-down list.
4. Enter the desired values in the **IP Address**, **Subnet Mask**, **Gateway**, **Primary DNS** and **Secondary DNS** fields respectively.

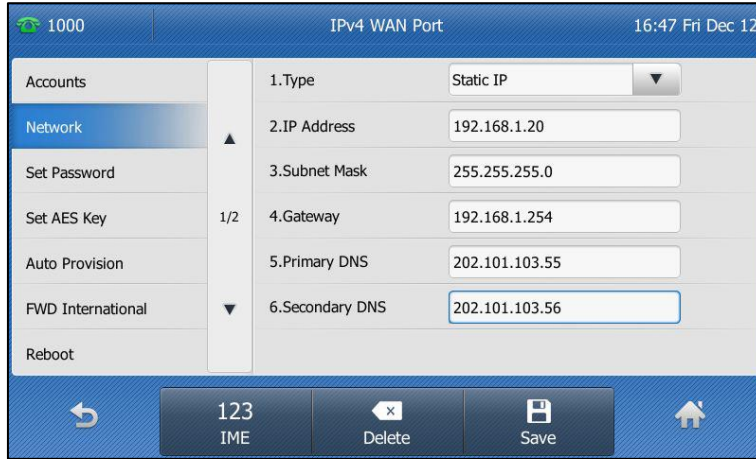

5. Tap the **Save** soft key to accept the change or ↶ to cancel.

**To configure a static IPv6 address via phone user interface:**

1. Tap  -> **Advanced** (default password: admin) -> **Network**->**WAN Port**->**IPv6**.
2. Tap the gray box of the **Type** field.
3. Tap **Static IP** from the pull-down list.
4. Enter the desired values in the **IP Address**, **IPv6 IP Prefix**, **Gateway**, **Primary DNS** and **Secondary DNS** fields respectively.

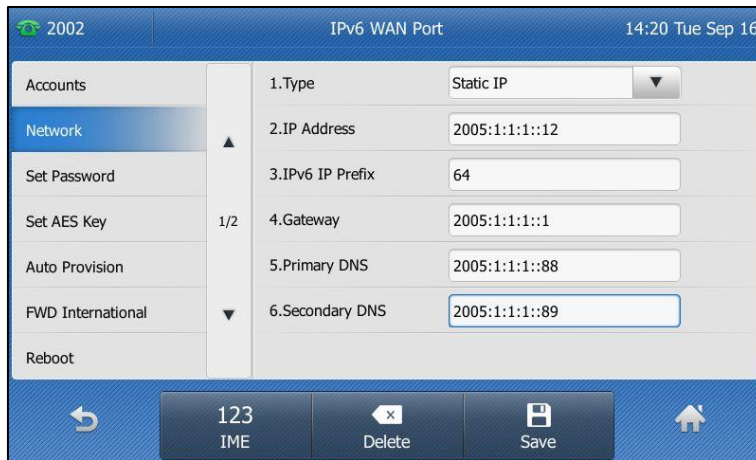

5. Tap the **Save** soft key to accept the change or ↶ to cancel.



If you are using an xDSL modem for IPv4 network connection, you can connect your phone to the Internet via PPPoE mode. Set the WAN port as a PPPoE port. The PPPoE port will perform a PPP negotiation to obtain the IP address. Contact your system administrator for the PPPoE user name and password.

**To configure PPPoE via phone user interface:**

1. Tap  -> **Advanced** (default password: admin) -> **Network**-> **WAN Port**-> **IPv4**.
2. Tap the gray box of the **Type** field.
3. Tap **PPPoE** from the pull-down list.
4. Enter the PPPoE user name and password in the corresponding fields.

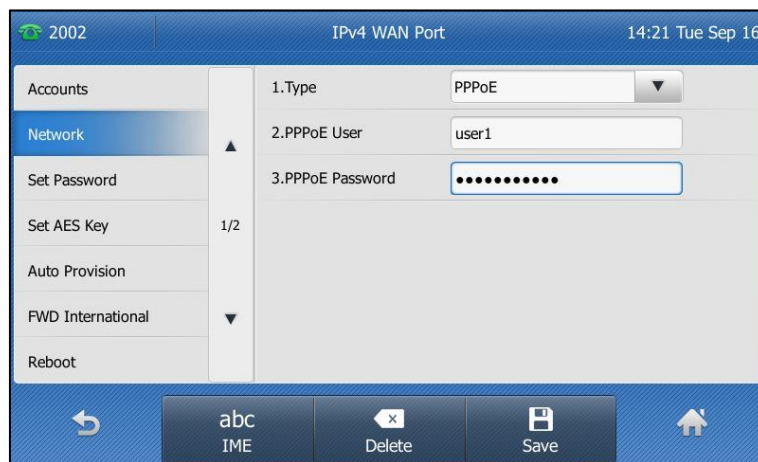

5. Tap the **Save** soft key to accept the change or  to cancel.

**Note**

Wrong network settings may result in inaccessibility of your phone and may also have an impact on your network performance. For more information on these parameters, contact your system administrator.



# Customizing Your Phone

---

You can customize your SIP-T48G IP phone by personally configuring certain settings, for example, wallpaper, time & date and ring tones. You can add contacts to the phone's local directory manually or from call history. You can also personalize different ring tones for different callers.

This chapter provides basic operating instructions for customizing your phone. Topics include:

- [General Settings](#)
- [Audio Settings](#)
- [Contact Management](#)
- [Call History Management](#)
- [System Customizations](#)

If you require additional information or assistance with your new phone, contact your system administrator.

## General Settings

### Wallpaper

You can customize the wallpaper of the SIP-T48G IP phone, and can change the wallpaper image via phone user interface or web user interface. You can also upload custom wallpaper images via web user interface. The file format of wallpaper image must be \*.jpg, \*.png or \*.bmp. A single file size must be less than 5M, and the total size of all custom wallpapers must be less than 20M.

**To change the wallpaper via phone user interface:**

1. Tap  -> **Basic Settings**->**Display**->**Wallpaper**.

2. Tap ◀ or ▶, or press ◀ or ▶ to select the desired wallpaper image.



3. Tap the **Save** soft key to accept the change or ↶ to cancel.

Wallpaper is configurable via web user interface at the path **Settings->Preference**.

To upload the custom wallpaper via web user interface:

1. Click on **Settings->Preference**.
2. In the **Upload Wallpaper (800\*480)** field, click **Browse** to locate the wallpaper image from your local system.

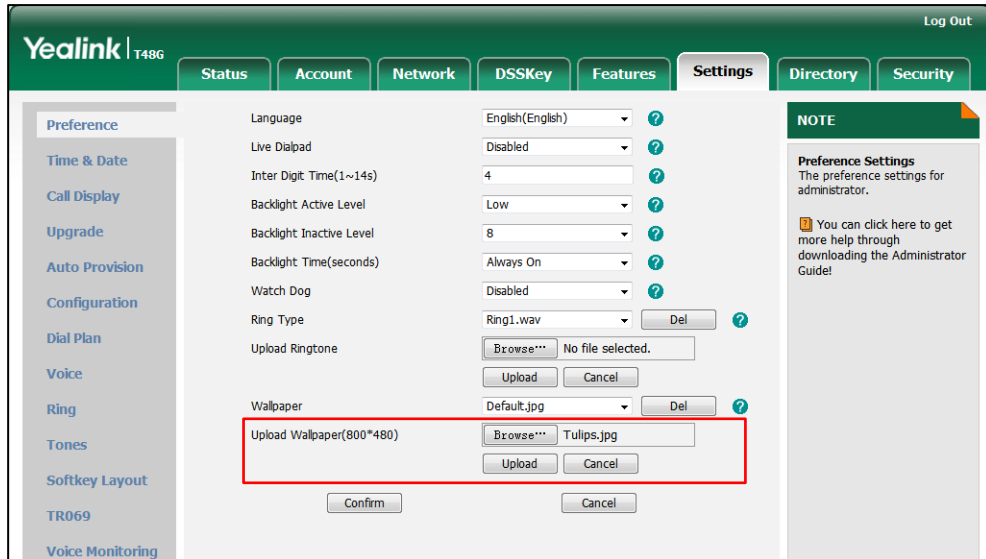

3. Click **Upload** to upload the file.
4. Click **Confirm** to accept the change.

The custom wallpaper appears in the pull-down list of **Wallpaper**.

**Note**

The SIP-T48G IP phone screen size is 800\*480 pixels. If the size of the custom wallpaper doesn't meet the IP phone screen size, the wallpaper will be stretched or/and zoomed out according to the IP phone screen size.

## Backlight

Backlight has three options:

**Backlight Active Level:** The intensity of the LCD screen when the phone is active. You can change the intensity of the LCD screen. Digits (1-10) represent different intensities. 10 is the highest intensity.

**Backlight Inactive Level:** The intensity of the LCD screen when the phone is inactive. You can select a low intensity or turn off the backlight.

**Backlight Time:** The delay time to change the intensity of the LCD screen when the phone is inactive. You can select a desired time to change the intensity or turn on the backlight permanently.

**To configure the backlight via phone user interface:**

1. Tap  -> **Basic Settings**->**Display**->**Backlight**.
2. Tap the gray box of the **Backlight Active Level** field.
3. Tap the desired level from the pull-down list.
4. Tap the gray box of the **Backlight Inactive Level** field.
5. Tap the desired value from the pull-down list.
6. Tap the gray box of the **Backlight Time** field.
7. Tap the desired time from the pull-down list.



8. Tap the **Save** soft key to accept the change or  to cancel.

Backlight is configurable via web user interface at the path **Settings**->**Preference**.

## Contrast

You can configure the contrast of the expansion module EXP40 connected to the SIP-T48G IP phone to a comfortable level on the phone. Ensure that the expansion module has been connected to the phone before configuration.

**To configure the contrast via phone user interface:**

1. Tap  -> **Basic Settings**-->**Display**->**Contrast**.
2. Tap the gray box of the **Contrast Level** field.
3. Tap the desired value from the pull-down list.

The default contrast level is 6.



4. Tap the **Save** soft key to accept the change or  to cancel.

## Language

The default language of the phone user interface is English. If the language of your web browser is not supported by the phone, the web user interface will use English by default. You can change the language for the phone user interface and the web user interface respectively.

**To change the language for the phone user interface:**

1. Tap  -> **Basic Settings**-->**Language**.
2. Tap ▲ or ▼ to scroll through the list of available languages.

3. Tap the desired language.



4. Tap the **Save** soft key to accept the change.  
Text displayed on the phone user interface will change to the selected language.

To change the language for the web user interface:

1. Click on **Settings->Preference**.
2. Select the desired language from the pull-down list of **Language**.

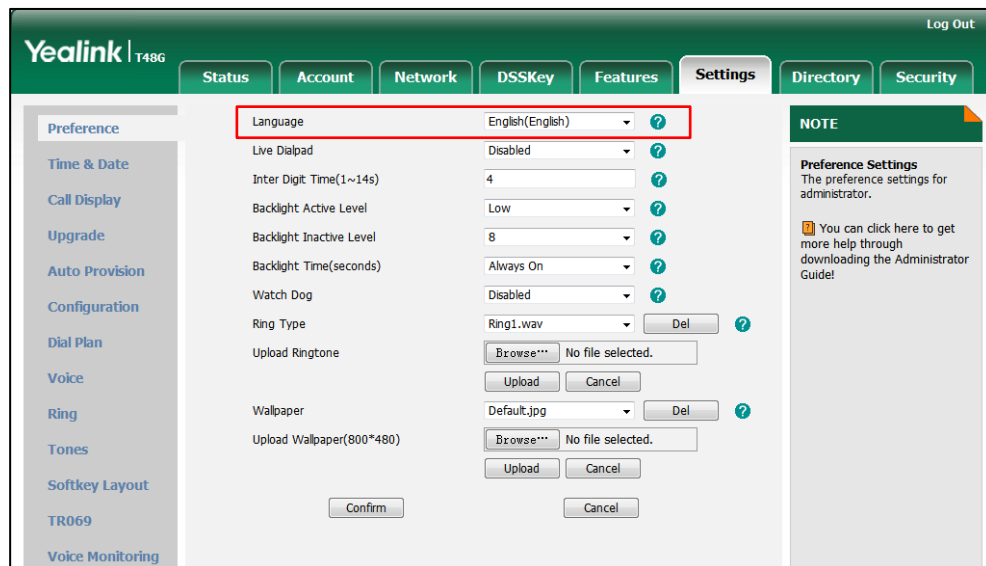

3. Click **Confirm** to accept the change.  
Text displayed on the web user interface will change to the selected language.

## Time & Date

The time and date are displayed on the right of the status bar. You can configure the phone to obtain the time and date from the SNTP server automatically, or configure the time and date manually. If the phone cannot obtain the time and date from the Simple

Network Time Protocol (SNTP) server, contact your system administrator for more information.

**To configure the SNTP setting via phone user interface:**

1. Tap  -> **Basic Settings**-->**Time & Date**->**General**.
2. Tap the gray box of the **Type** field.
3. Tap **SNTP Setting** from the pull-down list.
4. Tap the gray box of the **Time Zone** field.
5. Tap the time zone that applies to your area from the pull-down list.  
The default time zone is "+8 China(Beijing)".
6. Enter the domain names or IP addresses of SNTP servers in the **NTP Server 1** and **NTP Server 2** fields respectively.
7. Tap the gray box of the **Daylight Saving** field.
8. Tap the desired value from the pull-down list.



9. Tap the **Save** soft key to accept the change or  to cancel.

**Note** Please refer to [Appendix A - Time Zones](#) for the list of available time zones on the IP phone.

**To configure the time and date manually via phone user interface:**

1. Tap  -> **Basic Settings**-->**Time & Date**->**General**.
2. Tap the gray box of the **Type** field.
3. Tap **Manual Setting** from the pull-down list.



4. Enter the specific date and time in the corresponding fields.



5. Tap the **Save** soft key to accept the change.

The time and date displayed on the touch screen will change accordingly.

There are 7 available date formats. For example, for the date format “WWW DD MMM”, “WWW” represents the abbreviation of the weekday, “DD” represents the two-digit day, and “MMM” represents the first three letters of the month.

The date formats available:

Date Format	Example (2014-7-26)
WWW MMM DD	Sat Jul 26
DD-MMM-YY	26-Jul-14
YYYY-MM-DD	2014-07-26
DD/MM/YYYY	26/07/2014
MM/DD/YY	07/26/14
DD MMM YYYY	26 Jul 2014
WWW DD MMM	Sat 26 Jul

To configure the date and time format via phone user interface:

1. Tap  -> **Basic Settings**-->**Time & Date**->**Time & Date Format**.
2. Tap the gray box of the **Date Format** field.
3. Tap the desired date format from the pull-down list.
4. Tap the gray box of the **Time Format** field.

5. Tap the desired time format (12 Hour or 24 Hour) from the pull-down list.

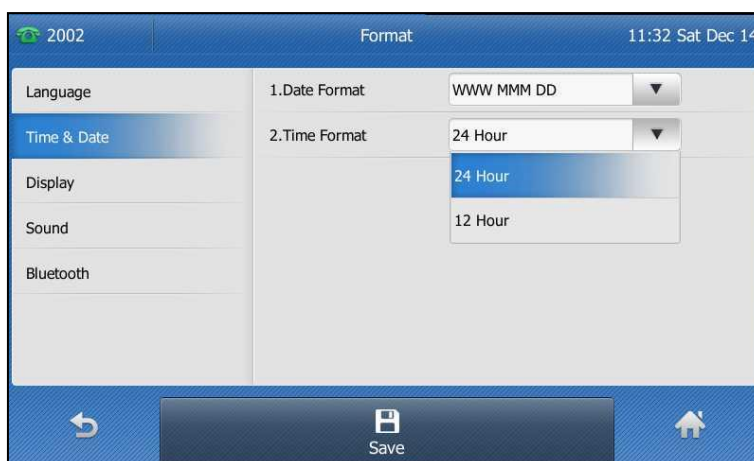

6. Tap the **Save** soft key to accept the change or  to cancel.

Time and date are configurable via web user interface at the path **Settings->Time & Date**.

## Administrator Password

The Advanced option is only accessible to the administrator. The default administrator password is “admin”. For security reasons, you should change the default administrator password as soon as possible.

**To change the administrator password via phone user interface:**

1. Tap  -> **Advanced** (default password: admin) -> **Set Password**.
2. Enter the old password in the **Current Password** field.
3. Enter the new password in the **New Password** field.
4. Re-enter the new password in the **Confirm Password** field.

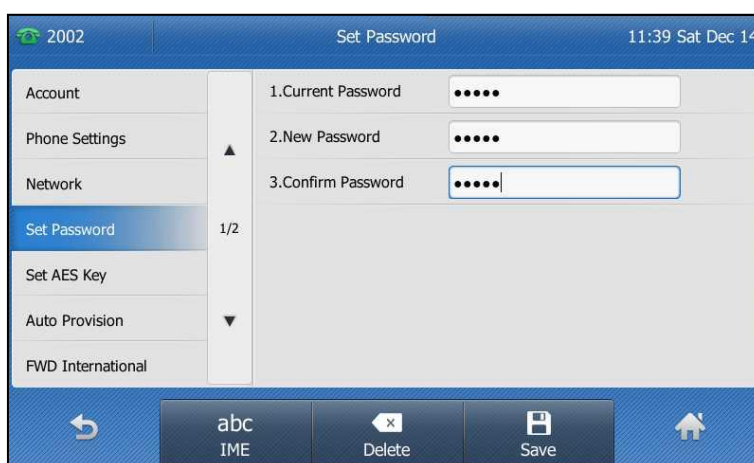

5. Tap the **Save** soft key to accept the change or  to cancel.

Administrator password is configurable via web user interface at the path **Security->Password**.

## Key as Send

You can set the "#" or "\*" to perform as a send key while dialing.

To configure key as send via phone user interface:

1. Tap  -> **Features->General**.
2. Tap the gray box of the **Key as Send** field.
3. Tap # or \* from the pull-down list, or tap **Disabled** to disable this feature.

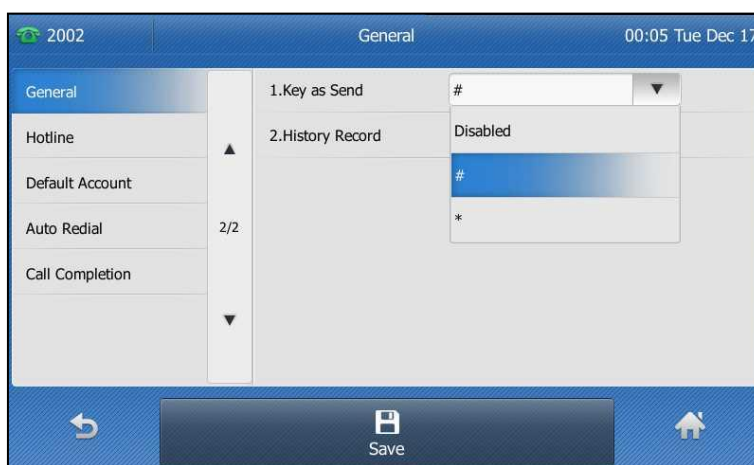

4. Tap the **Save** soft key to accept the change or  to cancel.

Key as send is configurable via web user interface at the path **Features->General Information**.

## Audio Settings

### Volume

You can press the volume key to adjust the ringer volume when the phone is idle. You can also press the volume key to adjust the receiver volume of currently engaged audio devices (handset, speakerphone or headset) when the phone is in use.

**To adjust the volume when the phone is idle:**

1. Press  to adjust the ringer volume.



**Note**

If the ringer volume is adjusted to minimum, the  icon will appear on the touch screen.

**To adjust the volume when the phone is during a call:**

1. Press  to adjust the volume of currently engaged audio device (handset, speakerphone or headset).



## Ring Tones

Ring tones are used to indicate incoming calls. You can select different ring tones to distinguish different accounts registered on your phone, or to distinguish your phone from your neighbor's.

**To select a ring tone for the phone via phone user interface:**

1. Tap  -> **Basic**->**Sound**->**Ring Tones**->**Common**.

2. Tap the desired ring tone.

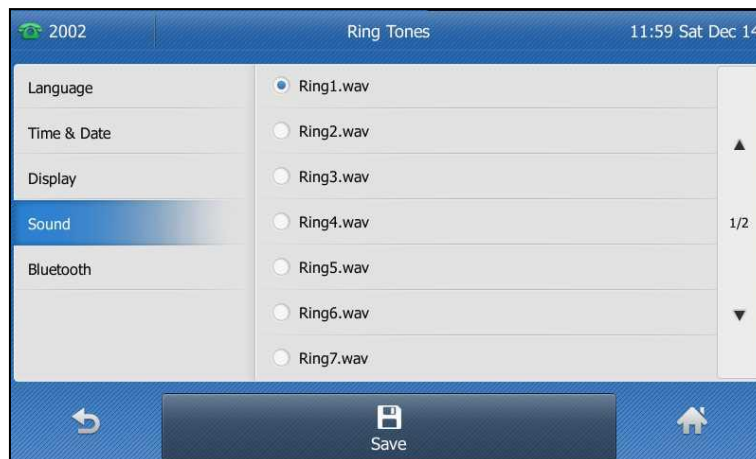

3. Tap the **Save** soft key to accept the change or  to cancel.

A ring tone for the phone is configurable via web user interface at the path **Settings->Preference->Ring Type**.

**To select a ring tone for the account via phone user interface:**

1. Tap  ->**Basic** ->**Sound**->**Ring Tones**.
2. Tap the desired account.
3. Tap the desired ring tone.

If **Common** is selected, this account will use the ring tone selected for the phone.

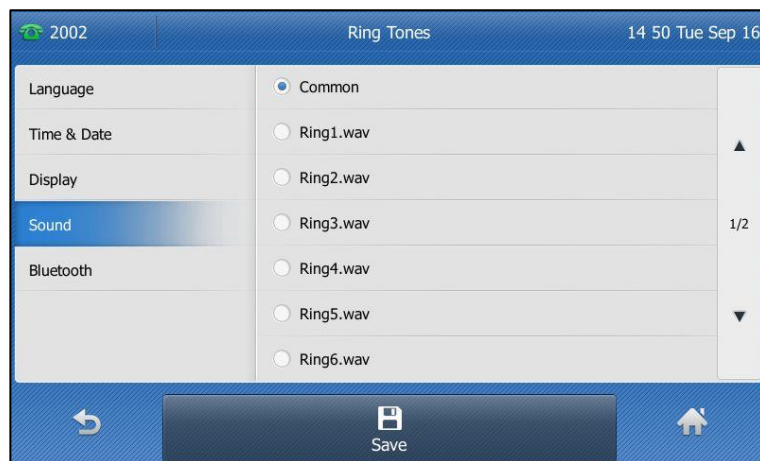

4. Tap the **Save** soft key to accept the change or the  to cancel.

A ring tone for the account is configurable via web user interface at the path **Account->Basic->Ring Type**.

**Note**

The ring tone for an incoming call on the phone may be different. For example, when the phone receives an incoming call from a contact stored in the local directory, it will play the ring tone assigned to the contact in the local directory (refer to [Adding Contacts](#)). If no ring tone is assigned to the contact, the phone will play the ring tone assigned to the associated group (refer to [Groups](#)). Otherwise, the phone will play the ring tone assigned to the account. If no ring tone is assigned to the contact, the associated group or account, the phone will play the ring tone assigned to the phone.

To upload a custom ring tone for your phone via web user interface:

1. Click on **Settings->Preference**.
2. In the **Upload Ringtone** field, click **Browse** to locate a ring tone file (the file format must be \*.wav) from your local system.

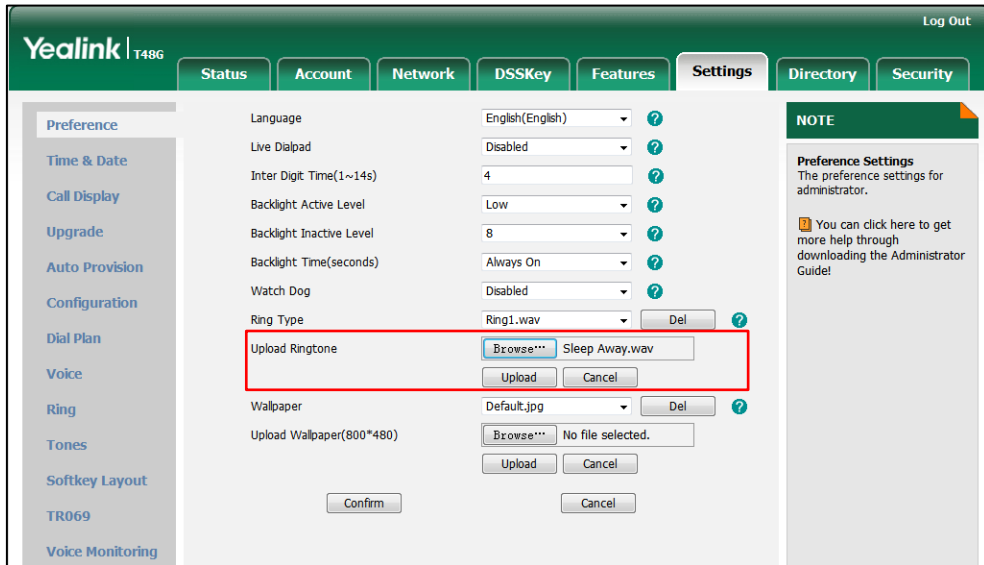

3. Click **Upload** to upload the file.

**Note**

All custom ring tone files must be no greater than 100KB. Uploading custom ring tones for your phone is configurable via web user interface only.

## Contact Management





This section provides the operating instructions for managing contacts. Topics include:

- [Directory](#)
- [Local Directory](#)
- [Blacklist](#)
- [Remote Phone Book](#)

## Directory

Directory provides easy access to frequently used lists. The lists may contain Local Directory, History, Remote Phone Book and LDAP.

To configure the directory via web user interface:

1. Click on **Directory->Setting**.
2. In the **Directory** block, select the desired list from the **Disabled** column and then click  .  
The selected list appears in the **Enabled** column.
3. Repeat step 2 to add more lists to the **Enabled** column.
4. To remove a list from the **Enabled** column, select the desired list and then click  .
5. To adjust the display order of the enabled lists, select the desired list and then click  or  .

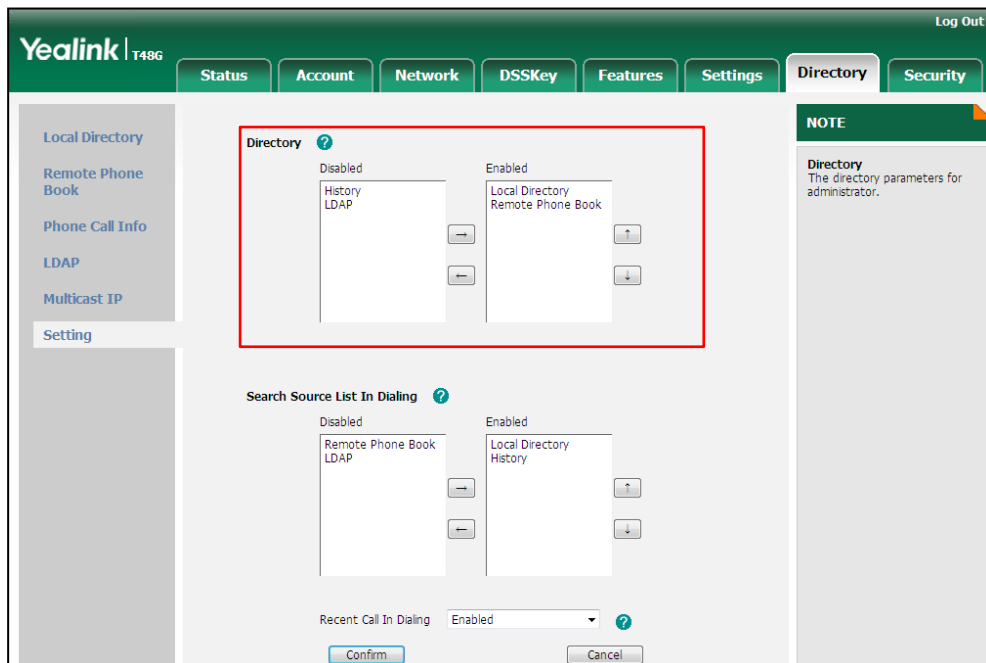

6. Click **Confirm** to accept the change.

### Note

Directory is configurable via web user interface only.

If the remote phone book and LDAP are not configured in advance, you cannot view remote phone book and LDAP lists on the phone user interface. For more information on remote phone book, refer to [Remote Phone Book](#) on page 58. For more information on LDAP, refer to *Yealink SIP-T4X\_IP\_Phones\_Administrator\_Guide*.

To view the directory via phone user interface:

1. Tap  when the phone is idle.

- If there is only one list is enabled for the directory, tap  to view the list directly.
- If more than one list is enabled for the directory, tap the desired list you want to view, and then tap the **OK** soft key.



## Local Directory

The built-in phone directory can store the names and phone numbers of your contacts. You can store up to 1000 contacts and 48 groups in your phone's local directory. There are three default groups in the local directory: Company, Family and Friend. You can add new groups and contacts, edit, delete or search for a contact, or simply dial a contact number from the local directory.

## Groups

**To add a group to the local directory:**

1. Tap  .

The IP phone enters the local directory directly as there is only Local Directory enabled in the directory by default.







If Local Directory is disabled for the directory, tap  -> **Directory**->**All Contacts** to enter the local directory.

2. Tap **Setting**.
3. Tap **New Group**.
4. Enter the desired group name in the highlighted field.



5. Tap  to accept the change.
6. Tap  to specify a ring tone for the group.
7. Tap the desired ring tone.



If **Auto** is selected, the contact in this group will use the ring tone specified for the contact. If no ring tone is specified for the contact, it will then play the ring tone specified for the account. For more information on the ring tone for the account, refer to [Ring Tones](#) on page 34.

8. Tap the **OK** soft key to accept the change.

You can also edit or delete the Company, Family, Friend and any newly added contact groups.

**To edit a group in the local directory:**

1. Tap  .

The IP phone enters the local directory directly as there is only Local Directory enabled in the directory by default.

If Local Directory is disabled for the directory, tap  ->Directory->All Contacts to enter the local directory.

2. Tap **Setting**.
3. Tap the desired group.
4. Tap  after the group name.

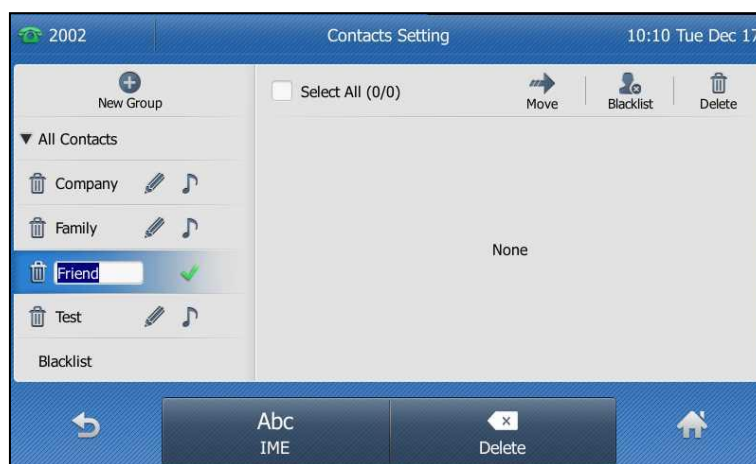



5. Edit the group name in the highlighted field.
6. Tap  to accept the change.

**To delete a group from the local directory:**

1. Tap  .

The IP phone enters the local directory directly as there is only Local Directory enabled in the directory by default.

If Local Directory is disabled for the directory, tap  ->Directory->All Contacts to enter the local directory.

2. Tap **Setting**.
3. Tap the desired group.
4. Tap  before the group name.

The touch screen prompts the following warning:

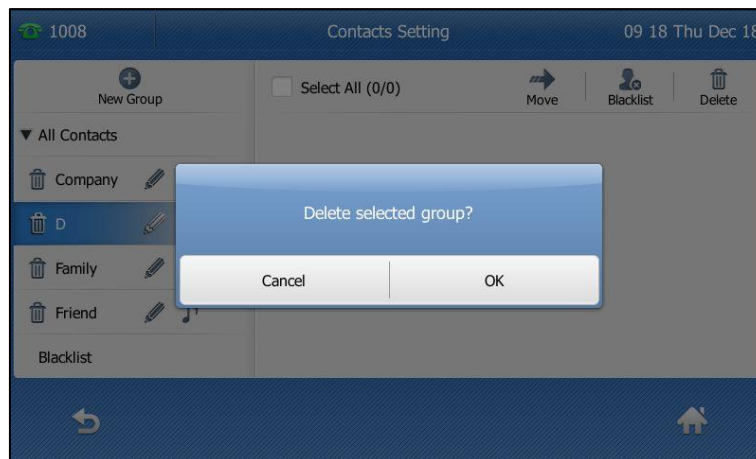

5. Tap the **OK** soft key to confirm the deletion or the **Cancel** soft key to cancel.

## Adding Contacts

You can add contacts to the local directory in one of the following ways:

- Manually
- From call history
- From a remote phone book

### Adding Contacts Manually

To add a contact to the local directory manually:

1. Tap .

The IP phone enters the local directory directly as there is only Local Directory enabled in the directory by default.

If Local Directory is disabled for the directory, tap  -> **Directory**-> **All Contacts** to enter the local directory.

2. Tap **Add**.

If you want add a contact to the specified contact group, you can tap the contact group first, and then tap **Add**.

3. Enter the name and the office, mobile or other numbers in the corresponding fields.

4. Tap the gray box of the **Account** field.
5. Tap the desired account from the pull-down list.  
If **Auto** is selected, the phone will use the first available account when placing calls to the contact from the local directory.
6. Tap the gray box of the **Ring** field.
7. Tap the desired ring tone from the pull-down list.  
If **Auto** is selected, this contact will use the ring tone assigned to the group.
8. Tap the gray box of the **Photo** field.
9. Tap the desired photo from the pull-down list.
10. Tap the **Save** soft key to accept the change or to cancel.

#### Note

If the contact already exists in the directory, the touch screen will prompt "Contact name existed!".

## Adding Contacts from Call History

To add a contact to the local directory from call history:

1. Tap .
2. Tap or to turn pages.  
You can also press or to switch pages.

3. Tap **i** after the desired entry.

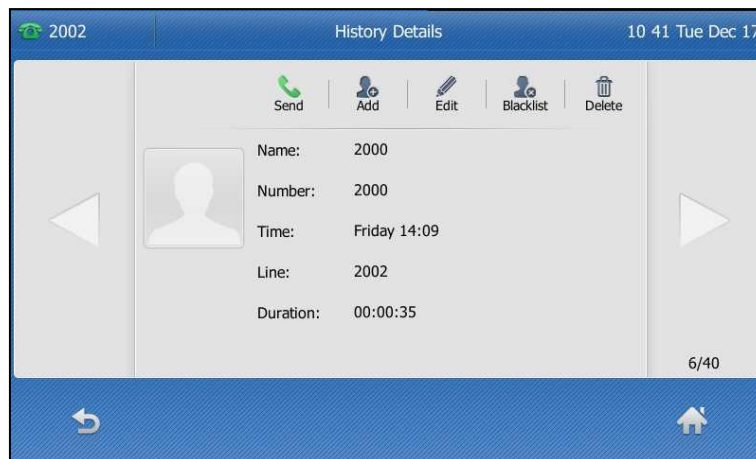

4. Tap **Add**.
5. Edit the corresponding fields.

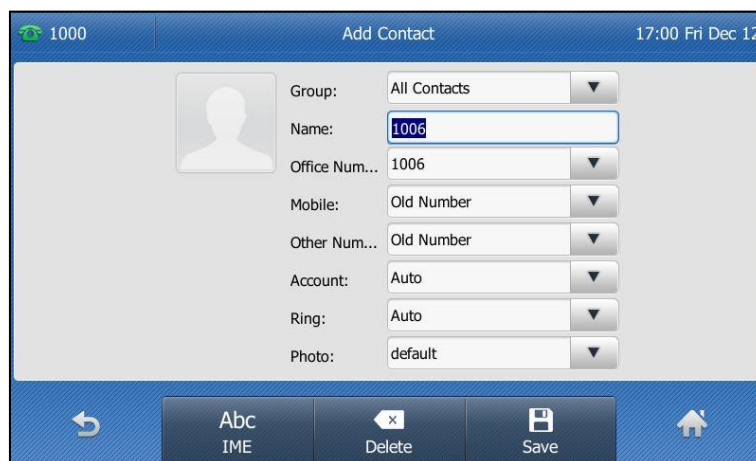

6. Tap the **Save** soft key to accept the change.  
The entry is successfully saved to the local directory.

## Adding Contacts from a remote phone book

To add a contact to the local directory from a remote phone book:

1. Tap  -> **Remote Phone Book** or tap  -> **Directory**->**Remote Phone Book** to enter the remote phone book.



2. Tap the desired remote phone book.

The phone then connects to the remote phone book and proceeds to load it. The contacts in the remote phone book are displayed on the touch screen.

3. Tap  after the desired contact in the remote phone book.

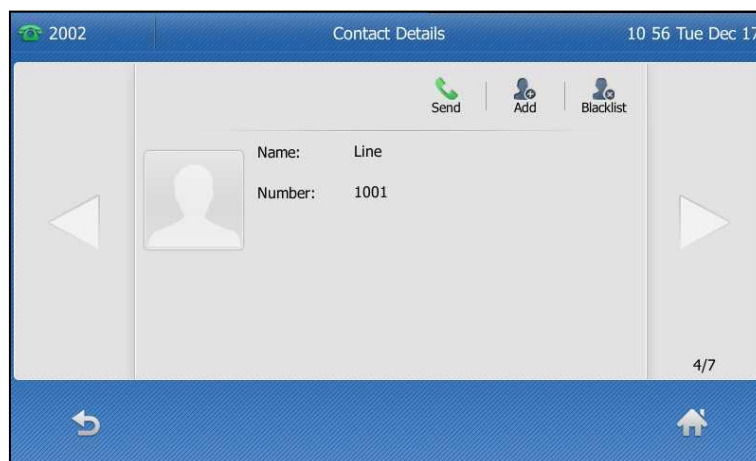

4. Tap **Add**.

5. Edit the corresponding fields.

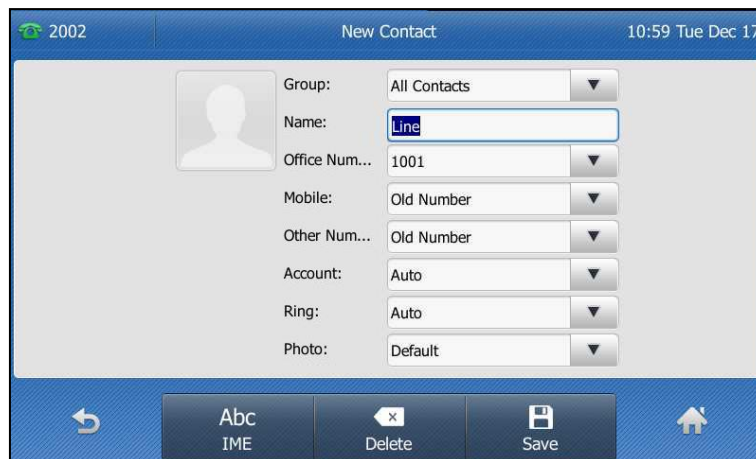

6. Tap the **Save** soft key to save the contact to the local directory.  
If the contact already exists in the local directory, the touch screen will prompt "Overwrite the original contact?". Tap the **OK** soft key to overwrite the original contact in the local directory or the **Cancel** soft key to cancel.

For more information on remote phone book operation, refer to [Remote Phone Book](#) on page 58.

## Editing Contacts

To edit a contact in the local directory:

1. Tap .

The IP phone enters the local directory directly as there is only Local Directory enabled in the directory by default.

If Local Directory is disabled for the directory, tap  -> **Directory**-> **All Contacts** to enter the local directory.

2. Tap  after the desired contact.

If the contact was added to a specified contact group, you can tap the contact group first, and then tap  after the desired contact.

3. Tap the desired field to edit the contact information.

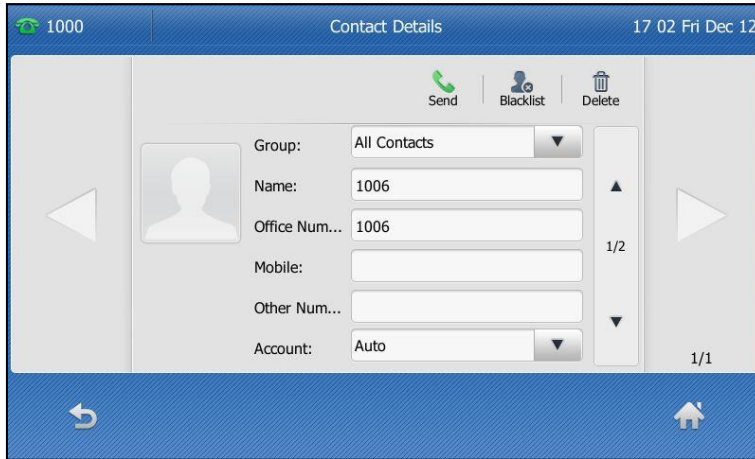

You can tap ◀ or ▶ to switch the contact you want to edit.

4. Tap the **Save** soft key to accept the change or ↶ to cancel.

## Deleting Contacts

To delete a contact from the local directory:

1. Tap .

The IP phone enters the local directory directly as there is only Local Directory enabled in the directory by default.

If Local Directory is disabled for the directory, tap  -> **Directory**->**All Contacts** to enter the local directory.



2. Tap  after the desired contact.

If the contact was added to a specified contact group, you can tap the contact group first, and then tap  after the desired contact.

3. Tap **Delete**.



The touch screen prompts the following warning:

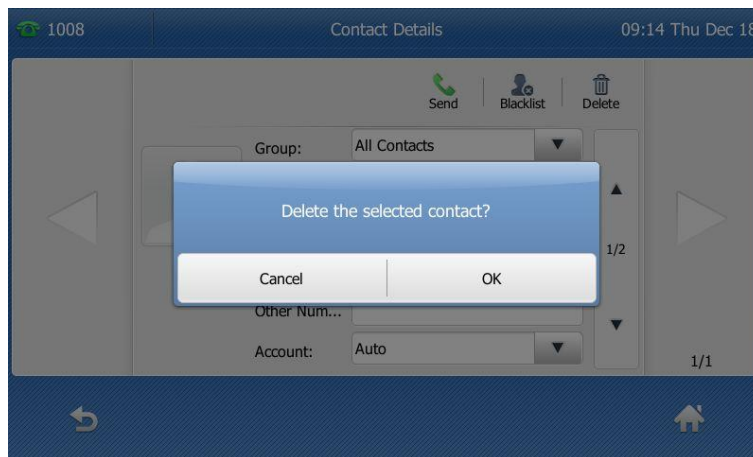

4. Tap the **OK** soft key to confirm the deletion or the **Cancel** soft key to cancel.

**To delete all contacts:**

1. Tap .

The IP phone enters the local directory directly as there is only Local Directory enabled in the directory by default.

If Local Directory is disabled for the directory, tap  -> **Directory**->**All Contacts** to enter the local directory.



2. Tap **Setting**.
3. Tap the checkbox of **Select All**.
4. Tap **Delete**.

The touch screen prompts the following warning:

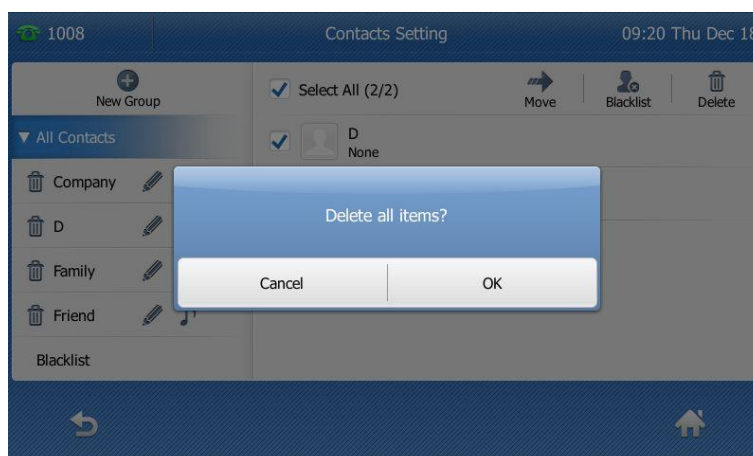

5. Tap the **OK** soft key to confirm the deletion or the **Cancel** soft key to cancel.

## Uploading Contact Photos

To upload a new custom photo for a contact via web user interface:

1. Click on **Directory->Local Directory**.
2. Click **Browse**, and then locate a photo file from your local computer.
3. Click **Upload Photo** to upload the photo.

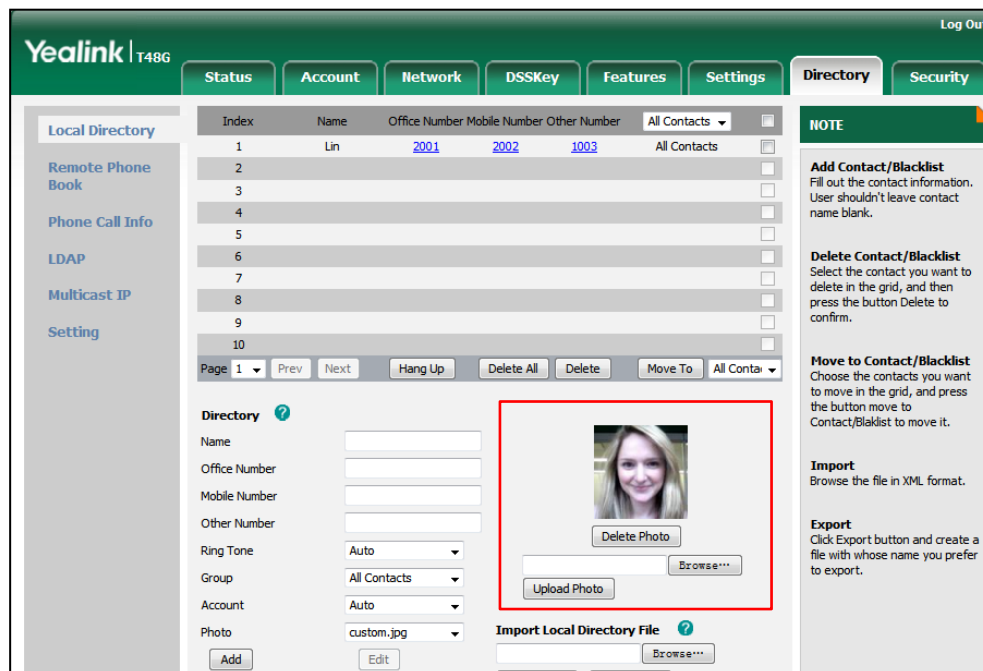

You can click **Delete Photo** to delete the custom photo.

### Note

The phone only supports \*.png, \*.jpg and .bmp format files. The file size must be less than 5M.

You can only delete custom photos.

To change the custom photo for the contact via web user interface:

1. Click on **Directory**->**Local Directory**.
2. Click the desired entry you want to edit.
3. Select the desired photo from the pull-down list of **Photo**.
4. Click **Edit** to accept the change.

When you place a call to the contact or receive a call from the contact, the touch screen will display the contact photo.

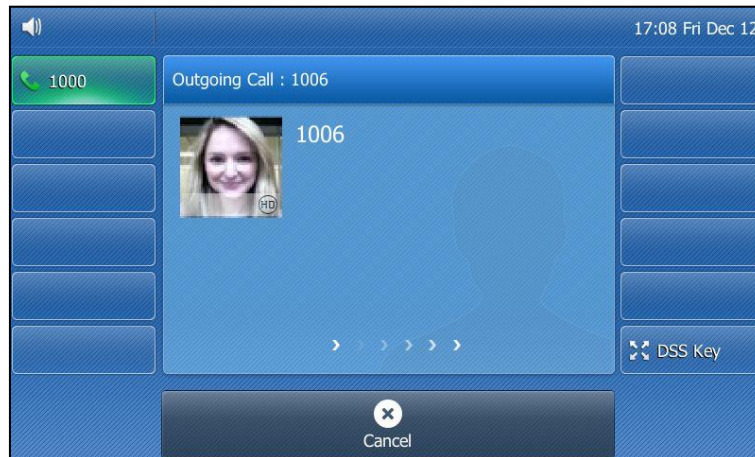

## Placing Calls to Contacts

To place a call to a contact from the local directory:

1. Tap .

The IP phone enters the local directory directly as there is only Local Directory enabled in the directory by default.



If Local Directory is disabled for the directory, tap  ->**Directory**->**All Contacts** to enter the local directory.

2. Tap the desired contact.

If the contact was added to a specified contact group, you can tap the contact group first, and then tap the desired contact.

- If only one number for the contact is stored in the local directory, the contact number will be dialed out.
- If multiple numbers for the contact are stored in the local directory, the touch screen will prompt:

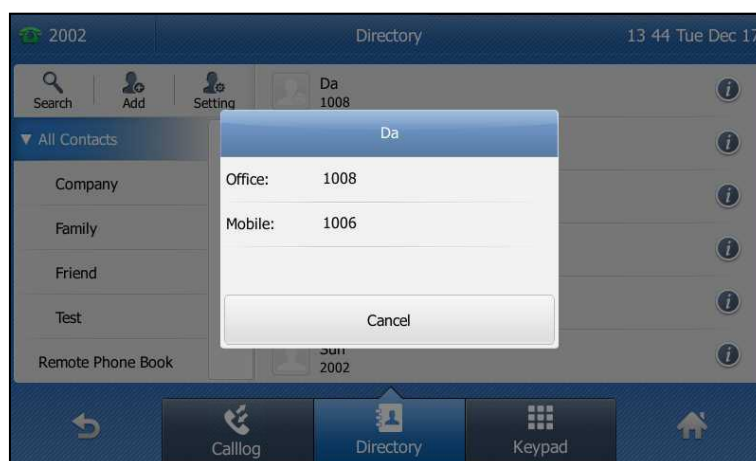

Tap the desired number.

The selected number will then be dialed out.

## Searching for Contacts

To search for a contact in the local directory:

1. Tap  .

The IP phone enters the local directory directly as there is only Local Directory enabled in the directory by default.

If Local Directory is disabled for the directory, tap  ->Directory->All Contacts to enter the local directory.

2. Tap **Search**.

3. Enter a few continuous characters of the contact name or continuous numbers of the contact number (office, mobile or other number) using the keypad.

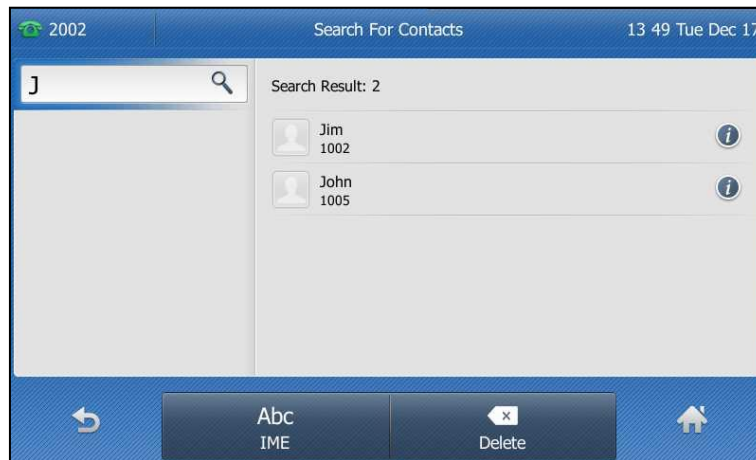

The contacts whose name or phone number matches the characters entered will appear on the touch screen. You can dial from the result list.

## Search Source List in Dialing



You can search for a contact from the desired lists when the phone is in the pre-dialing screen. The lists can be Local Directory, History, Remote Phone Book and LDAP.

**To configure search source list in dialing via web user interface:**

1. Click on **Directory->Setting**.
2. In the **Search Source List In Dialing** block, select the desired list from the **Disabled** column and click .

The selected list appears in the **Enabled** column.

3. Repeat step 2 to add more lists to the **Enabled** column.
4. (Optional.) To remove a list from the **Enabled** column, select the desired list and then click .

- To adjust the display order of the enabled list, select the desired list, and click  or  .

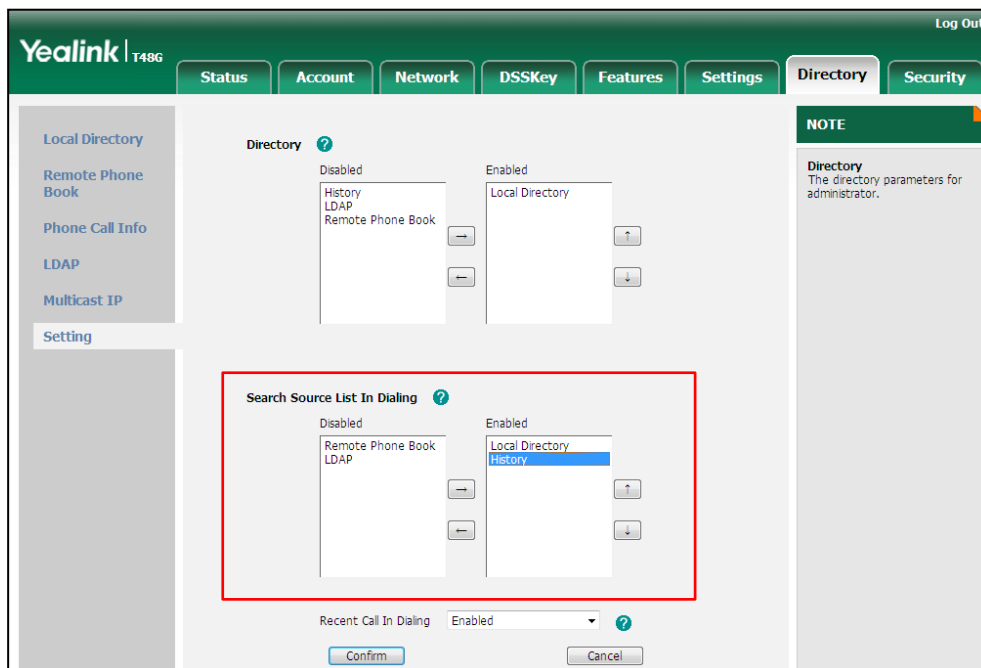

- Click **Confirm** to accept the change.  
The touch screen will display search results in the adjusted order.

**Note** Search source list in dialing is configurable via web user interface only.

**To search for an entry in the enabled search source lists:**

- Pick up the handset, press the speakerphone key or tap the line key.

2. Enter a few continuous characters of the entry's name or continuous numbers of the entry's phone number (office, mobile or other number).

The entries in the enabled search source lists whose name or phone number matches the characters entered will appear on the touch screen.

You can tap the desired entry to place a call to the entry.

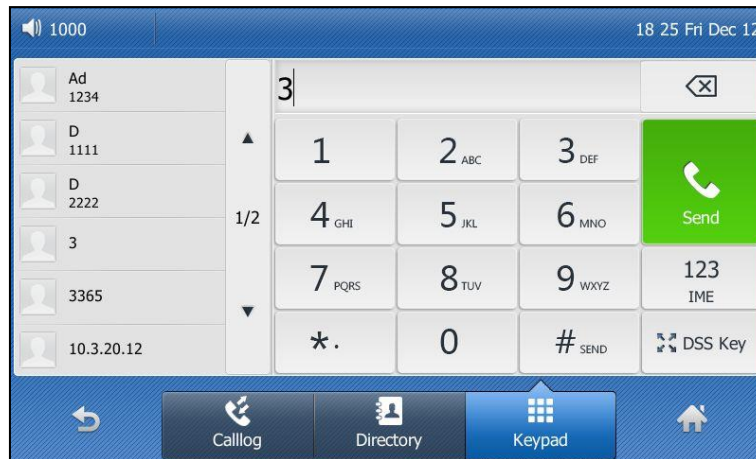

## Importing/Exporting Contact Lists

You can manage your phone's local directory via phone user interface or web user interface. But you can only import or export the contact list via web user interface.

**To import an XML contact list file via web user interface:**

1. Click on **Directory->Local Directory**.

- Click **Browse** to locate a contact list file (the file format must be \*.xml) from your local system.

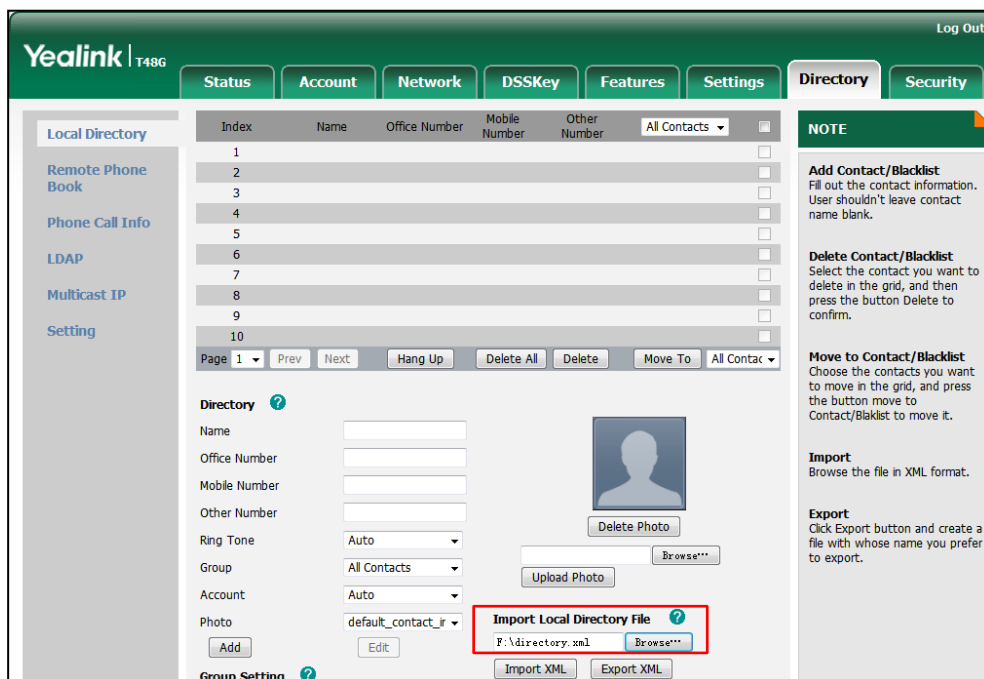

- Click **Import XML** to import the contact list.  
The web user interface prompts "The original contact will be covered, Continue?".
- Click **OK** to complete importing the contact list.

To import a CSV contact list file via web user interface:

- Click on **Directory->Local Directory**.
- Click **Browse** to locate a contact list file (the file format must be \*.csv) from your local system.
- (Optional.) Check the **Show Title** checkbox.



It will prevent importing the title of the contact information which is located in the first line of the CSV file.

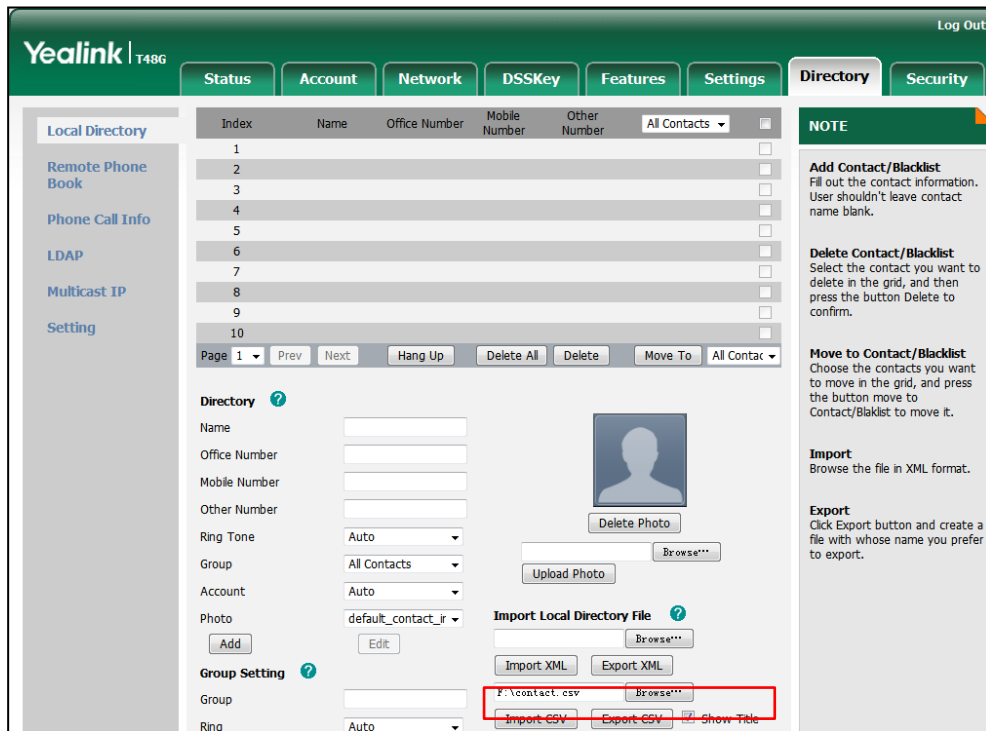

4. Click **Import CSV** to import the contact list.
5. (Optional.) Mark the **On** radio box in the **Delete Old Contacts** field.  
It will delete all existing contacts while importing the contact list.
6. (Optional.) Select the contact information you want to import into the local directory from the pull-down list of **Index**.  
At least one item should be selected to be imported into the local directory.

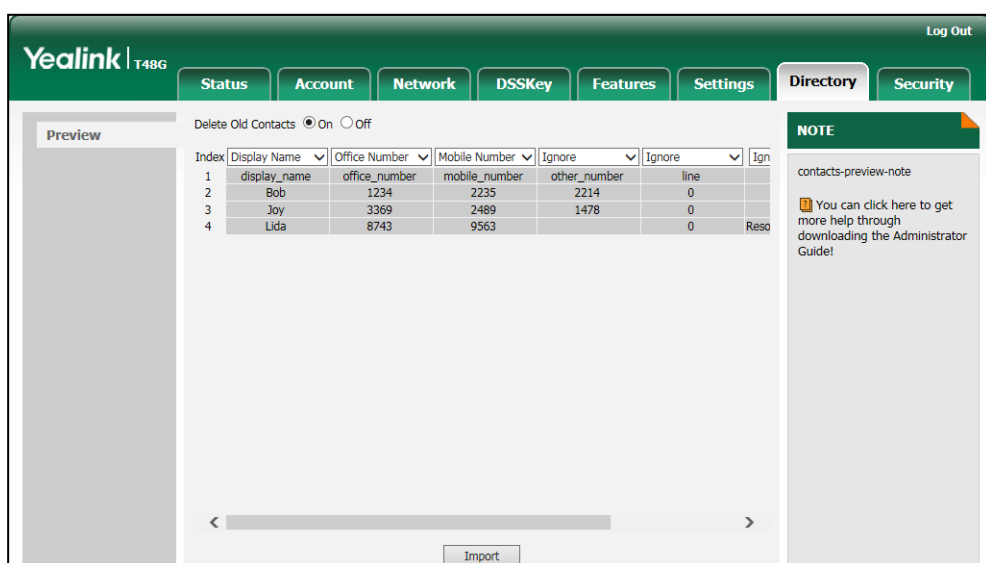

7. Click **Import** to complete importing the contact list.

**To export a contact list via web user interface:**

1. Click on **Directory**->**Local Directory**.
2. Click **Export XML** (or **Export CSV**).
3. Click **Save** to save the contact list to your local system.

**Note**

Importing/exporting contact lists is available via web user interface only.

## Blacklist

The built-in phone directory can store names and phone numbers for a blacklist. You can store up to 30 contacts; add, edit, delete or search for a contact in the blacklist directory, and even call a contact from the blacklist directory. Incoming calls from the blacklist directory contacts will be rejected automatically.

**To add a contact to the blacklist directory manually:**

1. Tap .

The IP phone enters the local directory directly as there is only Local Directory enabled in the directory by default.

2. Tap **Blacklist**.

If Local Directory is disabled for the directory, tap  ->**Directory**->**Blacklist** to enter the blacklist directory.







3. Tap **Add**.

4. Enter the contact's name and the office, mobile or other numbers in the corresponding fields.

The screenshot shows the 'Add Contact' interface. At the top, there's a status bar with '1000' on the left and '17:10 Fri Dec 12' on the right. The main area has a gray box on the left for a profile picture. To the right, there are several input fields: 'Group' (set to 'Blacklist'), 'Name' (set to 'Ad'), 'Office Num...' (set to '1234'), 'Mobile', 'Other Num...', and 'Account' (set to 'Auto'). At the bottom, there's a navigation bar with a back arrow, a '123 IME' field, a 'Delete' button, a 'Save' button, and a home icon.

5. Tap the gray box of the **Account** field.
6. Tap the desired account from the pull-down list.  
If **Auto** is selected, the phone will use the first available account when placing calls to the contact from the blacklist directory.
7. Tap the **Save** soft key to accept the change or  to cancel.

**To add a contact to the blacklist directory from the local directory:**

1. Tap .  
The IP phone enters the local directory directly as there is only Local Directory enabled in the directory by default.  
If Local Directory is disabled for the directory, tap  -> **Directory**-> **All Contacts** to enter the local directory.
2. Tap  after the desired contact.  
If the contact was added to a specified contact group, you can tap the contact group first, and then tap  after the desired contact.
3. Tap **Blacklist**.

The touch screen prompts the following warning:

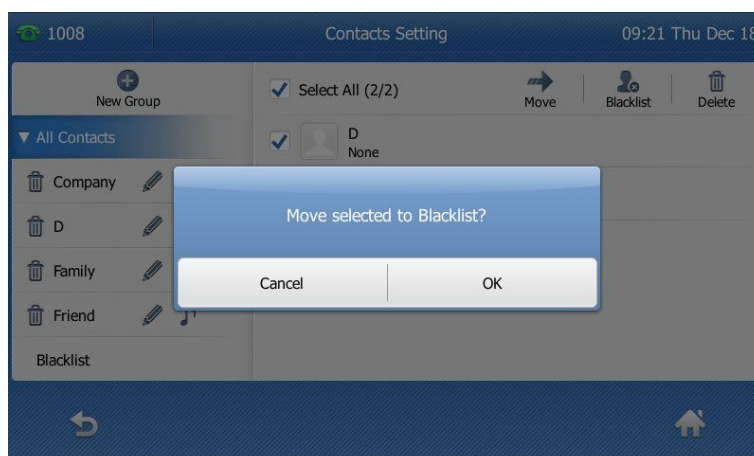

4. Tap the **OK** soft key to confirm the setting.

For operating instructions on editing, deleting, placing calls to and searching for contacts in the blacklist directory, refer to the operating instructions of [Local Directory](#) on page 38.

## Remote Phone Book

You can add contacts to the local directory, search for a contact, or simply dial a contact number from the remote phone book.

You can configure your new phone to access up to 5 remote phone books. The phone supports up to 5000 remote phone book entries. For the access URL of the remote phone book, contact your system administrator.

**To configure an access URL for a remote phone book via web user interface:**

1. Click on **Directory->Remote Phone Book**.
2. Enter the access URL in the **Remote URL** field.
3. Enter the name in the **Display Name** field.

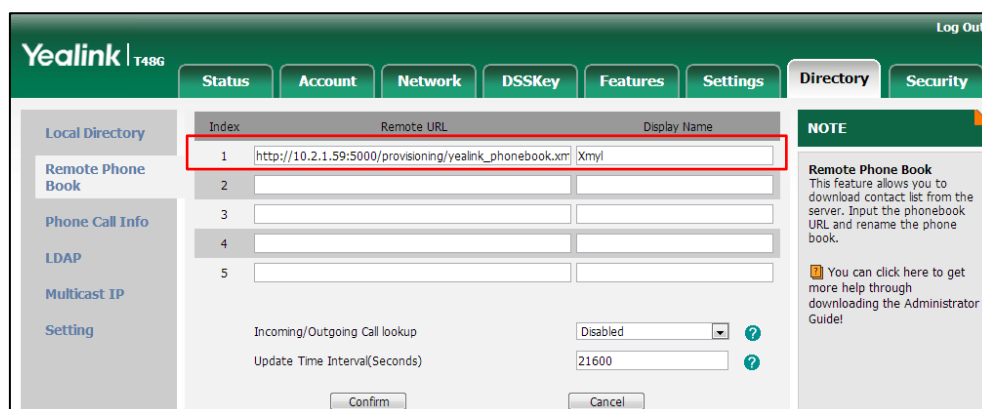



4. Click **Confirm** to accept the change.

**Note**

An access URL for a remote phone book is configurable via web user interface only.

If you want to tap  to enter the remote phone book, you should enable remote phone book in the directory lists in advance. For more information on the directory lists, refer to [Directory](#) on page 37.

**To access your remote phone book via phone user interface:**



1. Tap  ->**Remote Phone Book** or tap  ->**Directory**->**Remote Phone Book** to enter the remote phone book.
2. Tap the desired remote phone book.

The phone then connects to the remote phone book and proceeds to load it. The contacts in the remote phone book are displayed on the touch screen.



You can tap  to back to the previous interface.

**To search for a contact in the remote phone book:**

1. Tap  ->**Remote Phone Book** or tap  ->**Directory**->**Remote Phone Book** to enter the remote phone book.
2. Tap **Search**.

3. Enter a few continuous characters of the contact name or continuous numbers of the contact number using the keypad.



The contacts whose name or phone number matches the characters entered will appear on the touch screen. You can place a call from the result list.

**To place a call from the remote phone book:**

1. Tap -> **Remote Phone Book** or tap -> **Directory**->**Remote Phone Book** to enter the remote phone book.
2. Tap the desired remote phone book to load the remote phone book.
3. Tap the desired contact in the remote phone book.

In addition, you can enable the phone to present the caller identity stored in the remote phone book when receiving a call.

**To enable the presentation of caller identity stored in a remote phone book via web user interface:**

1. Click on **Directory**->**Remote Phone Book**.
2. Select **Enabled** from the pull-down list of **Incoming/Outgoing Call lookup**.
3. Enter the desired refresh period in the **Update Time Interval (Seconds)** field.

The default value is 21600 seconds.

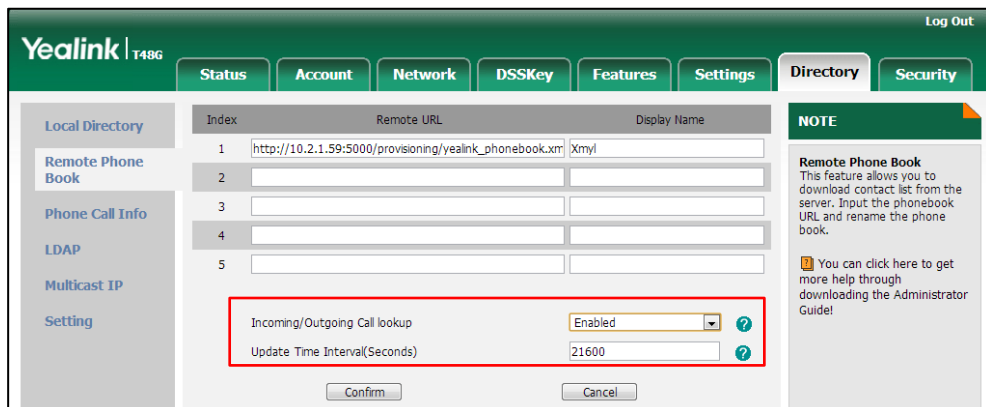

4. Click **Confirm** to accept the change.

## Call History Management

The SIP-T48G IP phone maintains call history lists of Missed calls, Placed calls, Received calls and Forwarded calls. Call history lists support up to 400 entries. You can view call history, place a call, add a contact or delete an entry from the call history list.

History record feature is enabled by default, if you don't want to save the call history, you can disable the feature.



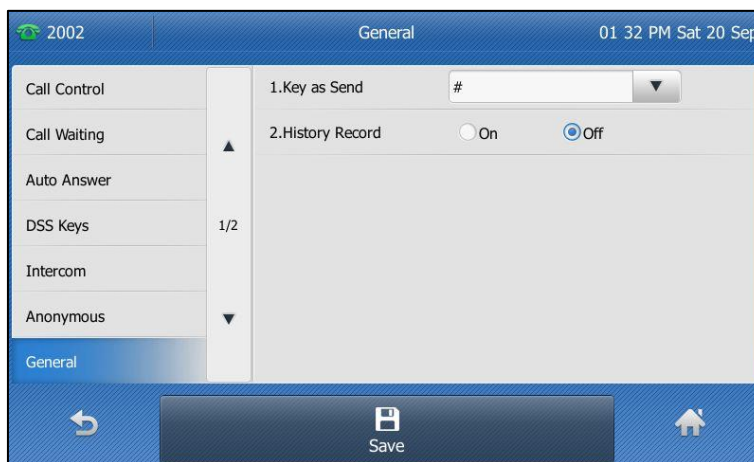

**To disable history record via phone user interface:**

1. Tap  -> **Features**->**General**.
2. Tap the **Off** radio box of the **History Record** field.



3. Tap the **Save** soft key to accept the change or  to cancel.

**To view call history:**

1. Tap  .  
The touch screen displays all call records.
2. Tap ▲ or ▼ to turn pages.  
You can also press  or  to switch pages.  
You can tap **Missed Calls**, **Placed Calls**, **Received Calls** or **Forwarded Calls** to view entries in each call list directly.
3. Tap  after the desired entry.

The detailed information of the entry appears on the touch screen.

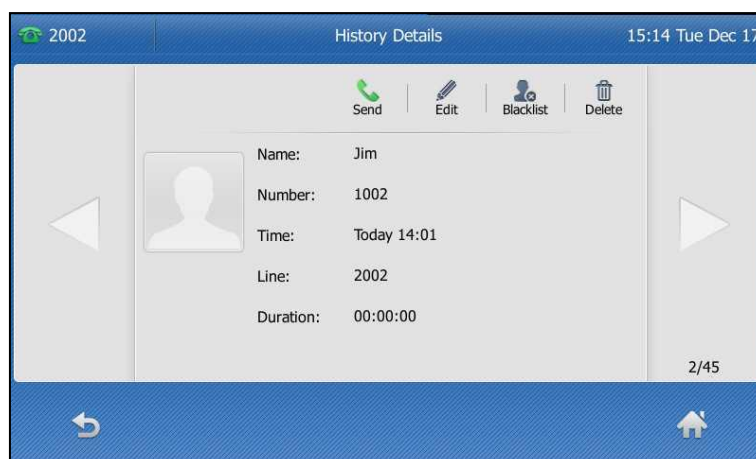



**To place a call from the call history list:**

1. Tap .

The touch screen displays all call records.

2. Tap ▲ or ▼ to turn pages.

You can also press  or  to switch pages.

You can tap **Missed Calls**, **Placed Calls**, **Received Calls** or **Forwarded Calls** to view entries in each call list directly.

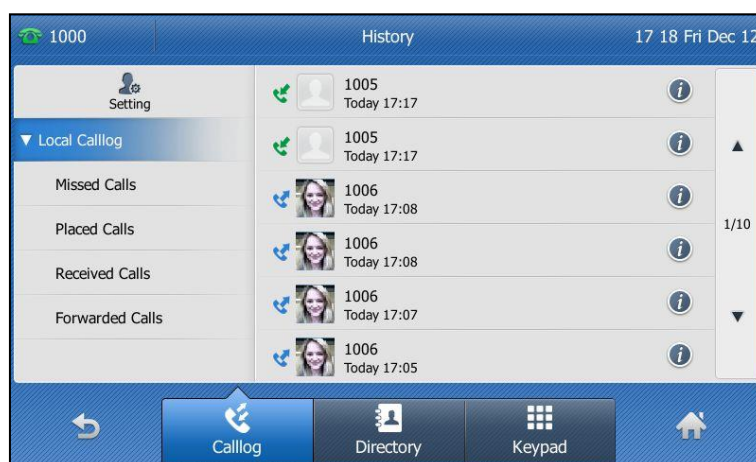

3. Tap the desired entry.

**To add a contact to the blacklist directory from the call history list:**

1. Tap .

The touch screen displays all call records.

2. Tap ▲ or ▼ to turn pages.

You can also press  or  to switch pages.

You can tap **Missed Calls**, **Placed Calls**, **Received Calls** or **Forwarded Calls** to view



entries in each call list directly.



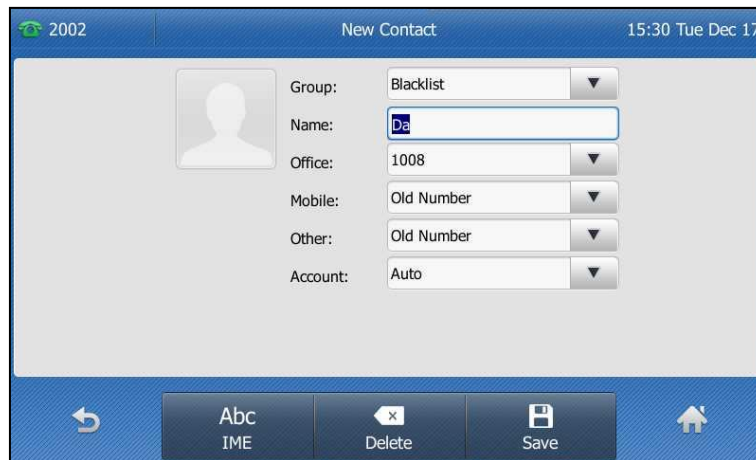



3. Tap  after the desired entry.
4. Tap **Blacklist**.



5. Enter the desired values in the corresponding fields.
6. Tap the **Save** soft key.

For more information, refer to [Contact Management](#) on page 36.

**To delete an entry from the call history list:**

1. Tap  .  
The touch screen displays all call records.
2. Tap  or  to turn pages.  
You can also press  or  to switch pages.  
You can tap **Missed Calls**, **Placed Calls**, **Received Calls** or **Forwarded Calls** to view entries in each call list directly.
3. Tap  after the desired entry.
4. Tap **Delete**.

The touch screen prompts the following warning:

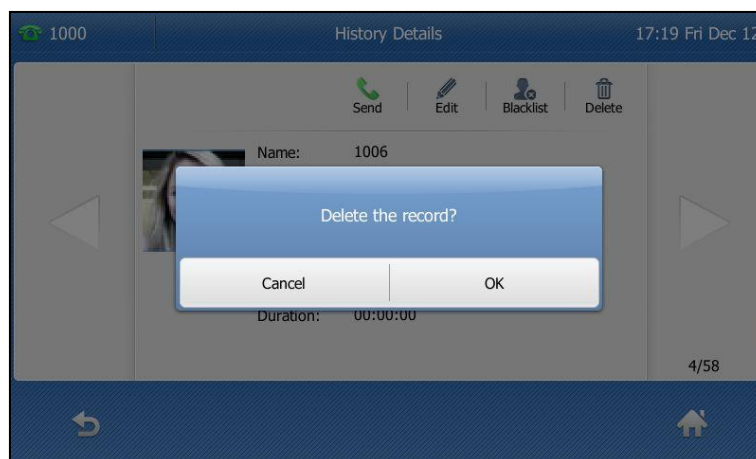

5. Tap the **OK** soft key to confirm the deletion or the **Cancel** soft key to cancel.

**To delete all entries from the call history list:**

1. Tap  .  
The touch screen displays all call records.
2. Tap ▲ or ▼ to turn pages.  
You can also press (▲) or (▼) to switch pages.  
You can tap **Missed Calls**, **Placed Calls**, **Received Calls** or **Forwarded Calls** to view entries in each call list directly.
3. Tap **Setting**.
4. Tap the checkbox of **Select All**.

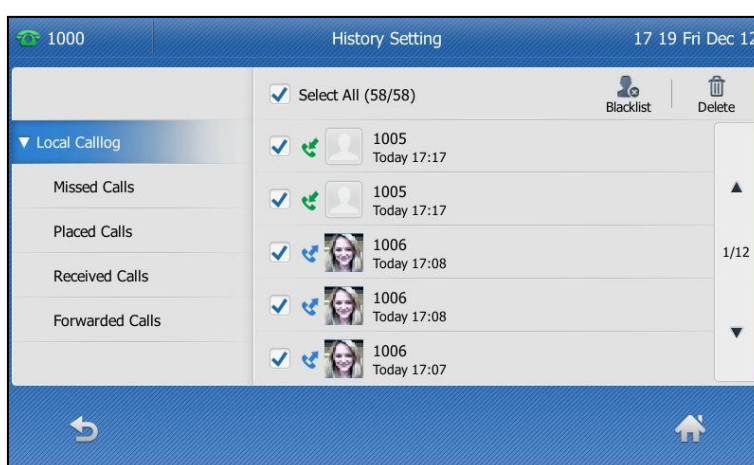

5. Tap **Delete**.

The touch screen prompts the following warning:

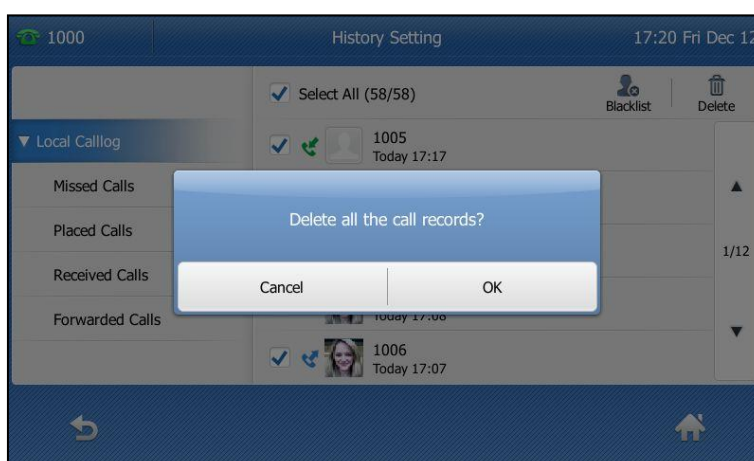

6. Tap the **OK** soft key to confirm the deletion or the **Cancel** soft key to cancel.

## System Customizations

### Headset Use

If you want to use a wired headset, physically connect your headset and activate the headset mode for use. For more information on physically connecting a headset, refer to [Phone Installation](#) on page 12.

If you want to use a wireless headset, insert the Bluetooth USB dongle BT40 into the USB port on the back of the phone. For more information on using a Bluetooth headset, refer to [Bluetooth Headset](#) on page 67.

This section provides an introduction to wired headset use.

#### Note

If both a Bluetooth headset and a wired headset are connected, only the Bluetooth headset can be used.

### Headset Mode Activation/Deactivation

#### To activate the headset mode:

1. Press  on the phone.

The HEADSET key LED illuminates solid green, and the icon  appears on the status bar of the touch screen when the headset mode is activated. When you tap the line key or the **Answer** soft key to answer an incoming call, the call is connected to your headset automatically. For more information on using the headset to answer a call, refer to [Answering Calls](#) on page 100.

With the handset on-hook, enter the desired number and tap the **Send** soft key, the phone will then place a call using the headset automatically. For more information on using the headset to place a call, refer to [Placing Calls](#) on page 98.

#### To deactivate the headset mode:

1. Press  again on the phone.

The HEADSET key LED goes out, and the icon  disappears from the touch screen when the headset mode is deactivated.

### Headset Prior

You can use headset in priority when headset prior feature is enabled. This feature is especially useful for permanent or full-time headset users.

#### To enable headset prior via web user interface:

1. Click on **Features->General Information**.

2. Select **Enabled** from the pull-down list of **Headset Prior**.

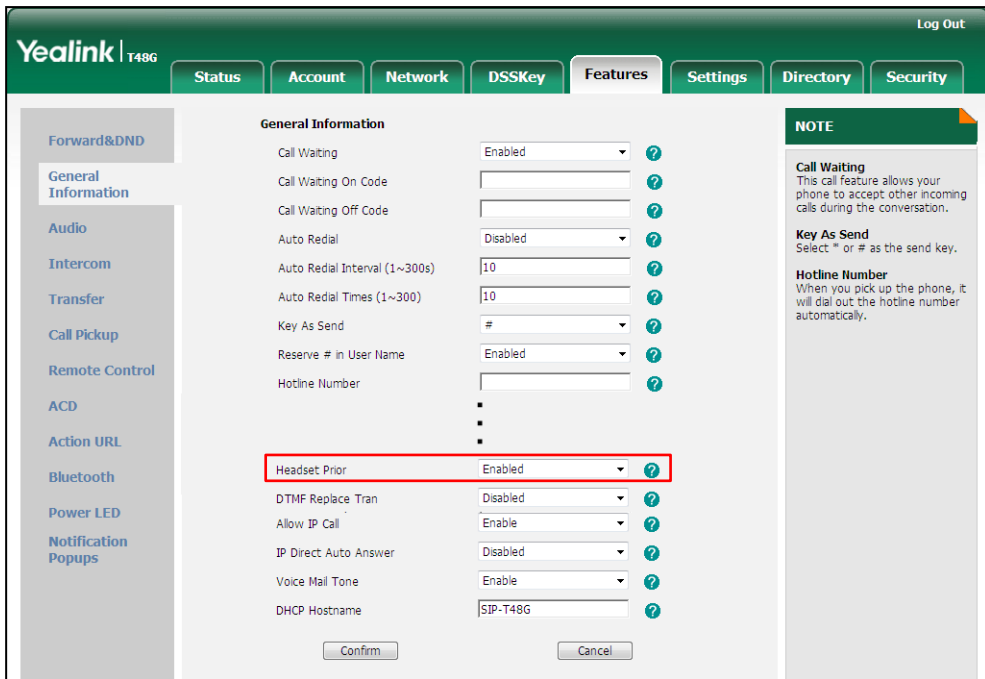

3. Click **Confirm** to accept the change.

To use headset prior, you should activate the headset mode in advance:

1. Physically connect the headset.
2. Press  to activate the headset mode.

**Note**

If headset prior is enabled, the headset mode will not be deactivated until you press the **HEADSET** key again.

If headset prior is disabled, the headset mode can be deactivated by pressing the speakerphone key or the **HEADSET** key.

Headset prior is configurable via web user interface only.

## Dual Headset

You can use two headsets when dual headset feature is enabled. To use this feature, you must physically connect headsets to the headset jack and handset jack respectively. Once the phone connects to a call, the headset connected to the headset jack will have full-duplex capabilities, while the one connected to the handset jack will only be able to listen.

To enable dual headset via web user interface:

1. Click on **Features->General Information**.

2. Select **Enabled** from the pull-down list of **Dual-Headset**.

The screenshot shows the Yealink T48G web interface. The 'Features' tab is selected, and the 'General Information' section is visible. The 'Dual-Headset' option is highlighted with a red box and is set to 'Enabled'. Other options include Call Waiting, Auto Redial, Key As Send, and Hotline Number. A 'NOTE' section on the right provides details for Call Waiting, Key As Send, and Hotline Number.

3. Click **Confirm** to accept the change.

**Note** Dual headset is configurable via web user interface only.

## Bluetooth Headset

The SIP-T48G IP phone supports Bluetooth. Bluetooth enables low-bandwidth wireless connections within a range of 10 meters (32 feet). The best performance is in the 1 to 2 meter (3 to 6 feet) range.

You can activate/deactivate the Bluetooth mode, and then pair and connect the Bluetooth headset with your phone. You can pair up to 30 Bluetooth headsets with your phone; however, only one headset can be connected at a time. You can also disconnect and delete your Bluetooth headset from the phone.

**Note** Ensure that the Bluetooth USB dongle BT40 is properly connected to the USB port on the back of the phone. For more information, refer to [Phone Installation](#) on page 12.

**To activate the Bluetooth mode via phone user interface:**

1. Tap  -> **Basic**-> **Bluetooth**.

2. Tap the **On** radio box of the **Bluetooth** field.

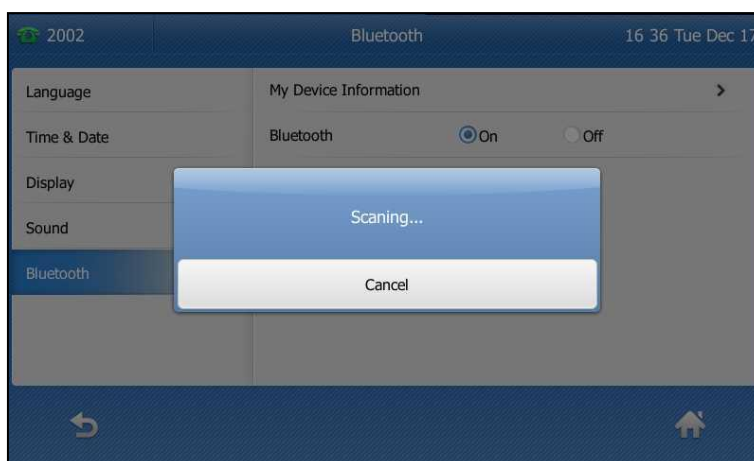

The IP phone scans the available Bluetooth headset automatically.

The LCD screen displays the Bluetooth device information (device name and MAC address).



Before you pair a Bluetooth headset, check the indicator on the Bluetooth headset to make sure that the Bluetooth headset is discoverable. For more information, refer to the documentation from the Bluetooth headset manufacturer.

**To pair and connect your Bluetooth headset to your phone:**

1. Tap  -> **Basic**-> **Bluetooth**.
2. Tap the found Bluetooth device to connect the Bluetooth headset to your phone.

If there is no Bluetooth devices found on the touch screen, tap the **Scan** soft key to search for the Bluetooth device.



3. Enter the PIN in the prompted **Password** field.

The default PIN is "0000".



4. Tap the **OK** soft key.

The Bluetooth headset is then automatically connected to your phone. The touch screen displays as below:



The Bluetooth icon  appears on the touch screen.



With the Bluetooth headset paired and connected, you can use the Bluetooth headset to place and answer calls. For more information, refer to the documentation from the Bluetooth headset manufacturer.

Auto connection feature enables or disables the phone to connect with the Bluetooth headset automatically. This feature is enabled by default.



### To configure auto connection feature via phone user interface:

1. Tap  -> **Basic**->**Bluetooth**.

The touch screen displays the paired and connected Bluetooth headset.



2. Tap  after the desired Bluetooth headset.
3. Tap the desired radio box of the **Auto Connect** field.

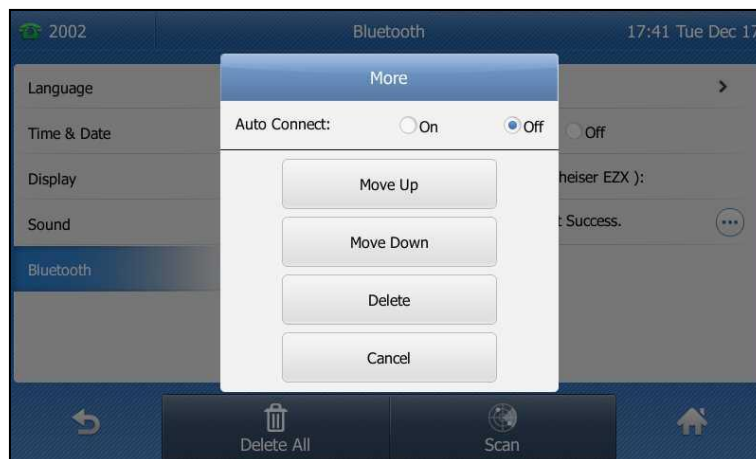

### To change the priority of paired Bluetooth devices:

1. Tap  -> **Basic**->**Bluetooth**.
2. Tap  after the desired Bluetooth headset.
3. Tap **Move Up** or **Move Down** from the prompt list.

The top device has the highest priority. If there is no Bluetooth headset connected, the phone will automatically connect to a Bluetooth headset with the highest priority.

You can disconnect the Bluetooth headset from your phone. After you disconnect the Bluetooth headset, it will still remain paired and be displayed in the **Bluetooth Devices** list. So you can easily connect it to your phone again.

**To disconnect your Bluetooth headset from your phone:**



1. Tap  -> **Basic**->**Bluetooth**.
2. Tap the connected Bluetooth headset.



The Bluetooth headset is disconnected. To connect it to your phone again, tap the Bluetooth headset again.

You can delete your Bluetooth headset from your phone. When you delete the Bluetooth headset, it disappears from the **Bluetooth Devices** list. To connect it to your phone again, you need to scan it first, and then connect it again.

**To delete your Bluetooth headset from your phone:**

1. Tap  -> **Basic**->**Bluetooth**.
2. Tap  after the desired Bluetooth headset you want to delete.
3. Tap the **Delete** soft key from the prompt list.

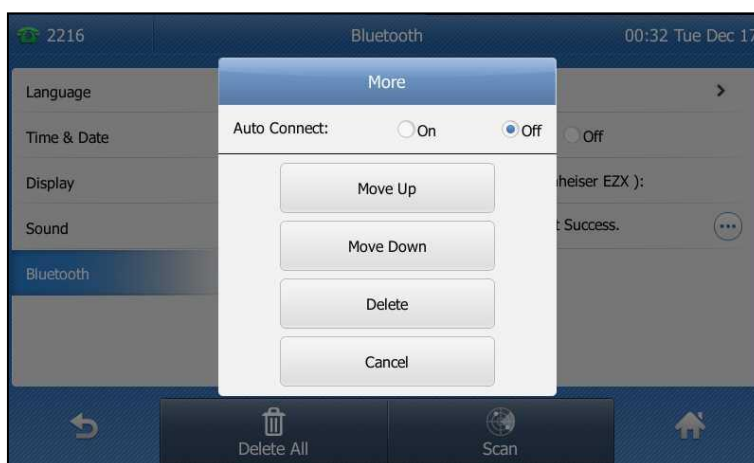

The touch screen prompts the following warning “Delete the selected item?”.

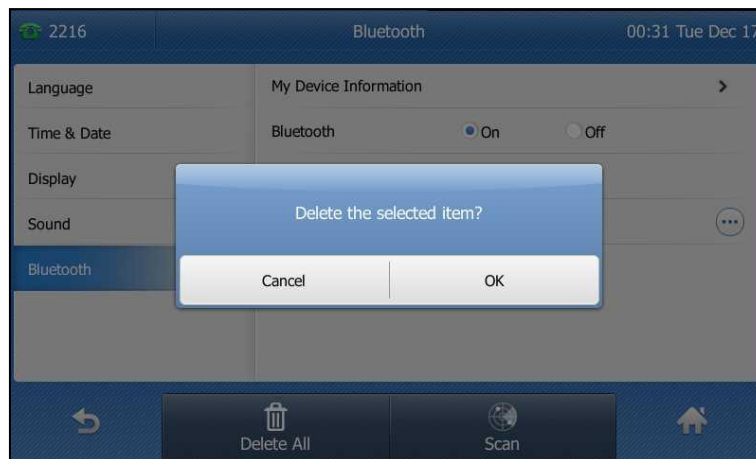

4. Tap the **OK** soft key to confirm the deletion or the **Cancel** soft key to cancel.  
You can also delete all headsets by tapping the **Delete All** soft key.

#### Note

If you cannot connect a Bluetooth headset to the phone successfully, we recommend that you delete the Bluetooth headset in the **Bluetooth Devices** list (if it exists) before pairing it.

**To deactivate the Bluetooth mode via phone user interface:**

1. Tap  -> **Basic**->**Bluetooth**.
2. Tap the **Off** radio box of the **Bluetooth** field.



The Bluetooth icon  disappears from the touch screen.

If a Bluetooth headset is paired and connected, and then you deactivate the Bluetooth mode, it will disappear from the **Bluetooth Devices** list. The Bluetooth headset won't be connected anymore, but it will still be paired. When you activate the Bluetooth mode again, the Bluetooth headset will be connected automatically if Auto connection feature is enabled.

Bluetooth mode is configurable via web user interface at the path **Features->Bluetooth**.



## DSS Keys

There are three types of DSS keys: Line Keys, Programmable Keys and Ext Keys. Details will be introduced in the following. The SIP-T48G IP phone supports 30 line keys.

### Line Keys

You can assign predefined functionalities to line keys. You can also define a label for a line key feature which will appear on the touch screen. Line keys allow you to quickly access features such as recall and voice mail. The line key can indicate the monitored status when the line keys are assigned with particular features, such as BLF. The default key type of line key 1-16 is Line. The default key type of line key 30 is DSS Key, which provides a quick access to the line key screen. You can also tap and hold the line keys 1-11 on the idle screen to enter the line key configuration screen directly.

**To assign functionality to a line key via phone user interface:**

1. Tap  -> **Features->DSS Keys**.
2. Tap the desired line key.
3. Select the desired key type from the **Type** field.
4. (Optional.) Select the desired key event type from the **Key Type** field.
5. (Optional.) Select the desired line from the **Account ID** field.
6. (Optional.) Enter a label that will appear on the touch screen in the **Label** field.
7. (Optional.) Enter the corresponding value in the **Value** field.
8. (Optional.) Enter the corresponding value in the **Extension** field.  
This option is only applicable to BLF feature. For more information, refer to [Busy Lamp Field \(BLF\)](#) on page 137.
9. Tap the **Save** soft key to accept the change or  to cancel.

You can also tap the line key 30 (DSS Key), and then tap the desired line key to assign functionality to it.

You can specify labels for some key features, which will be displayed on the idle LCD screen. If the length of the label exceeds the maximum display length, the phone only displays the first few characters. You can configure the phone to display more characters (up to 20 in two lines) via label length feature.

**To configure the label length via web user interface:**

1. Click on **DSSKey->Line Key**.

2. Select **Extended** from the pull-down list of **Label Length**.

The screenshot shows the Yealink T486 web interface. The 'DSSKey' tab is selected. A dropdown menu for 'Label Length' is open, showing 'Extended' selected. Below this is a table for configuring line keys:

Key	Type	Value	Label	Line	Extension
Line Key1	Line		2224	Line 1	
Line Key2	Line			Line 2	
Line Key3	Line			Line 3	
Line Key4	Line			Line 4	
Line Key5	Line			Line 5	
Line Key6	Line			Line 6	
Line Key7	Line			Line 7	
Line Key8	Line			Line 8	
Line Key9	Line			Line 9	
Line Key10	Line			Line 10	
Line Key11	Line			Line 11	

At the bottom of the table are 'Confirm' and 'Cancel' buttons. To the right is a 'NOTE' section with the following text:

**Key Type**  
The free function key 'Types' Speed Dial, Key Event, Intercom.

**Key Event**  
Key events are predefined shortcuts to phone and call functions.

**Intercom**  
Enable the 'Intercom' mode and it is useful in an office environment as a quick access to connect to the operator or the secretary.

You can click here to get more help through downloading the Administrator Guide!

3. Click **Confirm** to accept the change.

#### Note

Page icon status and label length features are configurable via web user interface only.

Line key features are explained in the following subchapters in detail:

- Line
- Speed Dial
- Voice Mail
- Directed Pickup
- Group Pickup
- DTMF
- Prefix
- Local Group
- XML Group
- XML Browser
- LDAP
- Conference
- Forward
- Transfer
- Hold
- DND
- Group Listening
- Zero Touch

- URL
- Directory

For the features not listed above, refer to [Basic Call Features](#) on page 97 and [Advanced Phone Features](#) on page 137. For more information, contact your system administrator.

### Line

You can use this key feature to accept incoming calls, place active calls on hold or resume a held call. It performs in the same way as a hard line key.

**Dependencies:** *Type (Line)*

*Account ID (the account this feature will be applied to)*

*Label (key label displayed on the LCD screen)*

**Usage:** When the phone receives an incoming call,

1. Tap the line key to accept the incoming call.
2. Tap the line key to place the active call on hold.
3. Tap the line key again to resume the held call.

### Speed Dial

You can use this key feature to speed up dialing the numbers frequently used or hard to remember.

**Dependencies:** *Type (Speed Dial)*

*Account ID (the account this feature will be applied to)*

*Label (key label displayed on the touch screen)*

*Value (the number you want to dial out)*

**Usage:** Tap the speed dial key to dial out the number specified in the **Value** field, using the account selected from the **Account ID** field.

### Voice Mail

You can use this key feature to quickly connect voice mail. For more information, refer to [Voice Mail](#) on page 158.

**Dependencies:** *Type (Key Event)*

*Key Type (Voice Mail)*

*Account ID (the account this feature will be applied to)*

*Label (key label displayed on the touch screen)*

*Value (the voice mail access code)*

**Usage:** Tap the voice mail key to dial out the voice mail access code. Then follow the voice prompt to listen to the voice mails.

### Directed Pickup

You can use this key feature to answer someone else's incoming call on the phone.

**Dependencies:** *Type (Key Event)*

*Key Type (DPickup)*

*Account ID (the account this feature will be applied to)*

*Label (key label displayed on the touch screen)*

*Value (the directed pickup code followed by the target phone number)*

**Usage:** Tap the directed pickup key on your phone when the target phone number receives an incoming call. The call is then answered on your phone.

### Group Pickup

You can use this key feature to answer incoming calls in a group that is associated with their own group.

**Dependencies:** *Type (Key Event)*

*Key Type (Gpickup)*

*Account ID (the account this feature will be applied to)*

*Label (key label displayed on the touch screen)*

*Value (the group pickup code)*

**Usage:** Tap the group pickup key on your phone when a phone number in the group receives an incoming call. The call is answered on your phone.

### DTMF

You can use this key feature to send the specification of arbitrary key sequences via DTMF.

**Dependencies:** *Type (Key Event)*

*Key Type (DTMF)*

*Label (key label displayed on the touch screen)*

*Value (DTMF sequence)*

### Note

DTMF sequence can only contain "0-9", "\*", "#" and "A-D".

**Usage:** Tap the DTMF key during an active call to send the key sequence specified in the **Value** field.

### Prefix

You can use this key feature to add a specified prefix number before the dialing number.

**Dependencies:** *Type (Key Event)*

*Key Type (Prefix)*

*Label (key label displayed on the touch screen)*

*Value (the prefix number)*

**Usage:** Tap the prefix key when the phone is idle, the phone will then enter the

pre-dialing screen and display the prefix number that you specified in the **Value** field. You can enter the remaining digits and then dial out.

### Local Group

You can use this key feature to quickly access a contact group in the local directory. For more information, refer to [Local Directory](#) on page 38.

**Dependencies:** *Type (Key Event)*

*Key Type (Local Group)*

*Local Group (the contact group name you want to access)*

*Label (key label displayed on the touch screen)*

**Usage:** Tap the local group key to access the contact group specified in the **Local Group** field.

### XML Group

You can use this key feature to quickly access a remote group in your remote phone book. You should configure a remote phone book in advance. For more information, refer to [Remote Phone Book](#) on page 58.

**Dependencies:** *Type (Key Event)*

*Key Type (XML Group)*

*XML Group (the remote group name you want to access if the remote phone book is configured)*

*Label (key label displayed on the touch screen)*

**Usage:** Tap the XML group key to access the remote group specified in the **XML Group** field.

### XML Browser

You can use this key feature to quickly access a XML browser. The XML browser allows you to create custom services which meet your functional requirements on the server. You can customize practical applications, such as weather report, stock information, Google search, etc.

**Dependencies:** *Type (Key Event)*

*Key Type (XML Browser)*

*Label (key label displayed on the touch screen)*

*Value (the access URL for XML browser)*

**Usage:** Tap the XML browser key to access the XML browser specified in the **Value** field.

### LDAP

You can use this key feature to quickly access a LDAP search screen.

**Dependencies:** *Type (Key Event)*

*Key Type (LDAP)*

*Label (key label displayed on the touch screen)*



**Usage:**

1. Tap the LDAP key to access the LDAP search screen.
2. Enter a few continuous characters of the contact name or continuous numbers of the contact number using the keypad.

The contacts whose name or phone number matches the characters entered will appear on the touch screen.

**Conference**

You can use this key feature to set up a conference call. For more information, refer to [Conference](#) on page 126.

**Dependencies: *Type (Key Event)***

*Key Type (Conference)*

*Label (key label displayed on the touch screen)*

*Value (the number you want to add to the conference)*

**Usage:** Tap the conference key during an active call to set up a conference with the number specified in the **Value** field.

**Note**

If the **Value** field is left blank, the conference key performs the same as the **Conference** soft key during a call.

**Forward**

You can use this key feature to forward an incoming call to someone else. For more information, refer to [Call Forward](#) on page 115.

**Dependencies: *Type (Key Event)***

*Key Type (Forward)*

*Label (key label displayed on the touch screen)*

*Value (the number you want to forward to)*

**Usage:** Tap the forward key to forward an incoming call to the number specified in the **Value** field.

**Note**

If the **Value** field is left blank, the forward key performs the same as the **Forward** soft key when receiving an incoming call.

**Transfer**

When there is an active call on the phone, you can use this key feature to handle the call differently depending on the transfer mode assigned to the DSS key.

**Dependencies: *Type (Key Event)***

*Key Type (Transfer)*

*Label (key label displayed on the touch screen)*

*Value (the number you want to transfer to)*

**Usage:**

- When the transfer mode on DSS key is **Blind Transfer**, tap the transfer key to complete the blind transfer to the number specified in the **Value** field.
- When the transfer mode on DSS key is **Attended Transfer**, tap the transfer key to dial out the number specified in the **Value** field, and then perform the attended or semi-attended transfer.
- When the transfer mode on DSS key is **New Call**, tap the transfer key to place a new call to the number specified in the **Value** field.

**Note**

Transfer mode via DSS key is configurable via web user interface at the path **Features->Transfer**. For more information on how to configure the transfer mode via DSS key, refer to [Busy Lamp Field \(BLF\)](#) on page 137.

If the **Value** field is left blank, the transfer key performs the same as the **TRANSFER** key or the **Transfer** soft key during a call. For more information, refer to [Call Transfer](#) on page 123.

**Hold**

You can use this key feature to place an active call on hold or retrieve a held call.

**Dependencies:** *Type (Key Event)*

*Key Type (Hold)*

*Label (key label displayed on the touch screen)*

**Usage:**

1. Tap the hold key during an active call to place the call on hold.
2. Tap the hold key again to retrieve the held call.

**DND**

You can use this key feature to activate or deactivate DND. You can also use this key feature to access the custom DND screen. For more information, refer to [Do Not Disturb \(DND\)](#) on page 110.

**Dependencies:** *Type (Key Event)*

*Key Type (DND)*

*Label (key label displayed on the touch screen)*

**Usage:**

When DND is in phone mode:

1. Tap the DND key to activate DND.
2. Tap the DND key again to deactivate DND.

When DND is in custom mode:

1. Tap the DND key to access the custom DND screen. You can activate or deactivate DND for one or all accounts.

## Group Listening

You can use this key feature to activate the Speakerphone and Handset/Headset mode at the same time. It is suitable for group conversations which have more than one person at one side. You are able to speak and listen through the handset/headset, while the others nearby can only listen through the speaker.

**Dependencies:** *Type (Key Event)*

*Key Type (Group Listening)*

*Label (key label displayed on the touch screen)*

**Usage:**

1. During a call, tap the group listening key to activate the group listening mode.  
You can then speak and listen through the handset/headset, while other people at your side can only listen through the speaker at the same time.
2. Tap the group listening key again to deactivate the group listening mode.

## Zero Touch

You can use this key feature to quickly configure auto provision and network parameters.

**Dependencies:** *Type (Key Event)*

*Key Type (Zero Touch)*

*Label (key label displayed on the touch screen)*

**Usage:**

1. Tap the zero touch key to access the zero touch screen.
2. Tap the **OK** soft key within a few seconds.
3. Configure the network parameters in the corresponding fields.
4. Tap the **Next** soft key.
5. Configure the auto provision parameters in the corresponding fields.
6. Tap the **Next** soft key.

The phone will reboot to update configurations.

## URL

You can use this key feature to trigger the phone to send an HTTP GET request containing a specific URL.

**Dependencies:** *Type (URL)*

*Label (key label displayed on the touch screen)*

*URL (the URL contained in the HTTP GET request)*

**Usage:** Tap the URL key to trigger the phone to send an HTTP GET request containing the URL specified in the **URL** field.

## Directory

You can use this key feature to easily access frequently used lists. For more information, refer to [Directory](#) on page 37.

**Dependencies:** *Type (Key Event)*

*Key Type (Directory)*

*Label (key label displayed on the touch screen)*

**Usage:** Tap the directory key to immediately access to frequently used lists.

### Note

The directory key performs the same function as the **Directory** soft key when the phone is idle.

## Programmable Keys

You can customize the soft keys, navigation keys and function keys.

**To customize programmable keys via web user interface:**

1. Click on **DSSKey->Programable Key**.
2. Customize specific features for these keys.

Key	Type	Line	Value	Label	Extension
SoftKey 1	History	Local History			
SoftKey 2	Directory	N/A			
SoftKey 3	DND	N/A			
SoftKey 4	Menu	N/A			
Up	History	Local History			
Down	N/A	N/A			
Left	Switch Account	N/A			
Right	Switch Account	N/A			
OK	Status	N/A			
Cancel	N/A	N/A			
HOLD	N/A	N/A			
MUTE	N/A	N/A			
TRAN	Forward	N/A			

3. Click **Confirm** to accept the change.

You can click **Reset to default** to reset custom settings to defaults.

Then you can press the keys on the phone to perform the features you configured.

For example:

### Switch Account Up

You can press this key to switch default account.

**Dependencies:** *Type (Switch Account Up)*

**Usage:** Press the programmable key to scroll up the account list to select the desired default account.

**Switch Account Down**

You can press this key to switch default account.

**Dependencies:** *Type (Switch Account Down)*

**Usage:** Press the programmable key to scroll down the account list to select the desired default account.

**Note** Programmable keys are configurable via web user interface only.

**Ext Keys**

You can customize features to Ext keys.

To customize Ext keys via web user interface:

1. Click on **DSSKey->Ext Key**.
2. Customize specific features for these keys.

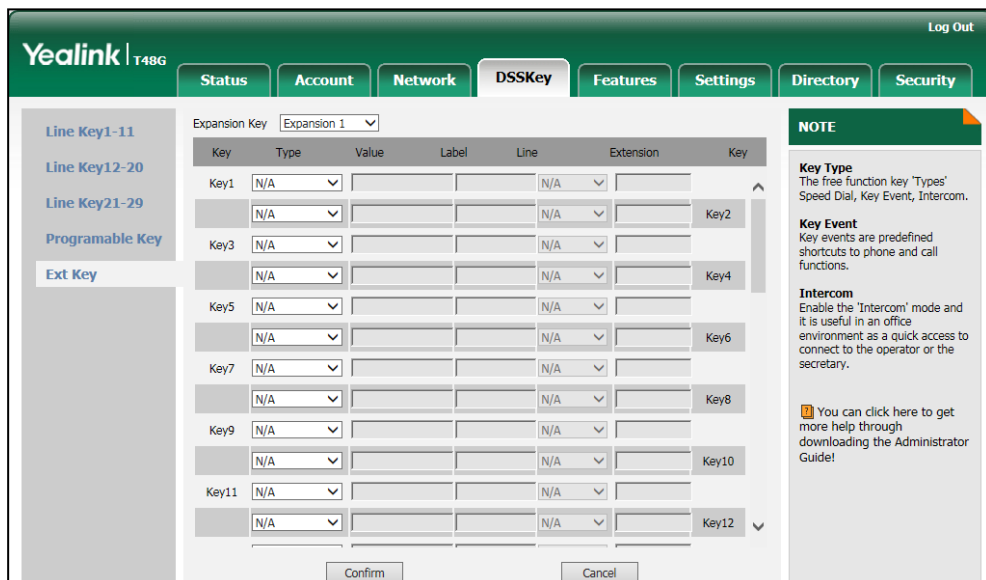

3. Click **Confirm** to accept the change.

For more information, refer to EXP40 User Guide.



**Note** Ext keys are configurable via web user interface only.

## Account Management

You can register one or multiple accounts on the SIP-T48G IP phone. You can also configure each line key to associate with an account or configure multiple line keys to associate with an account.

### Account Registration

To register an account via phone user interface:

1. Tap  -> **Advanced** (default password: admin) -> **Account**.
2. Tap the desired account.
3. Tap the gray box of the **Account Status** field.
4. Tap **Enabled** from the pull-down list.
5. Enter the desired values in the **Label**, **Display Name**, **Register Name**, **User Name**, **Password** and **SIP Server1/2** fields respectively. Contact your system administrator for more information.
6. Tap the **Save** soft key to accept the change or  to cancel.

You can repeat steps 2 to 5 to register more accounts.

The following figures demonstrate single or multiple accounts registered on the phone:



**Single account:**



**Multiple accounts:**



**To disable an account via phone user interface:**

1. Tap  -> **Advanced** (default password: admin) -> **Account**.
2. Tap the desired account.
3. Tap the gray box of the **Account Status** field.
4. Tap **Disabled** from the pull-down list.
5. Tap the **Save** soft key to accept the change or  to cancel.

Account registration is configurable via web user interface at the path **Account->Register**.

**To configure the default account via phone user interface:**

1. Tap  -> **Features->Default Account**.
2. Tap the gray box of the **Default Account** field.
3. Tap the desired account from the pull-down list.



4. Tap the **Save** soft key to accept the change or  to cancel.

The label of the default account is displayed on the left of the status bar. The IP phone

will use this account by default when dialing out.

You can also tap the label of the default account, and then tap the desired account to be the new default account.



You can also press ◀ or ▶ to select the desired account as the default account.

## Multiple Line Keys per Account

You can configure multiple line keys to associate with an account. This enhances call visualization and simplifies call handling.

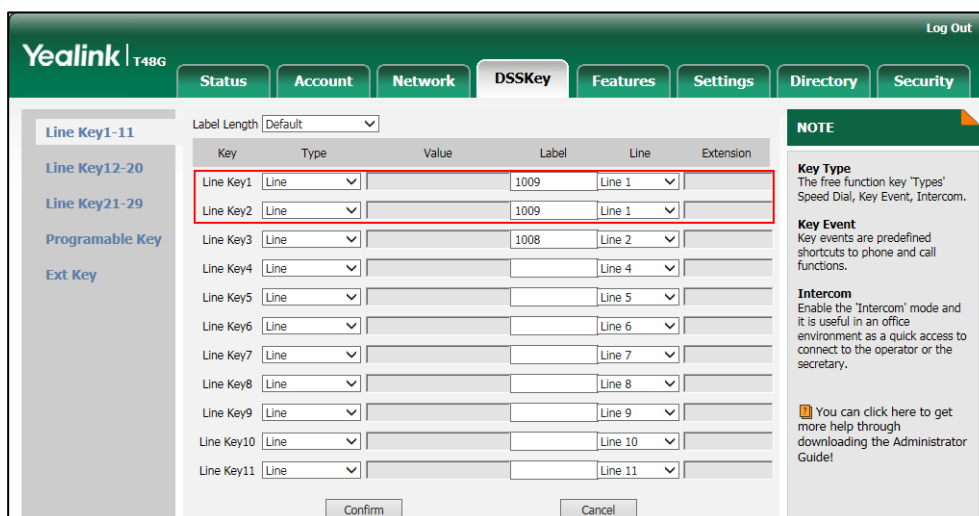



If this is the case, the touch screen will resemble the following figure:

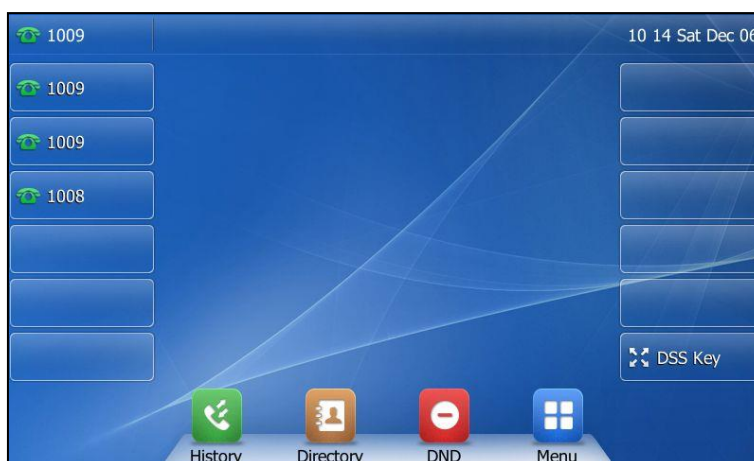

Incoming calls to this account will be distributed evenly among the available line keys. Outgoing calls will be distributed similarly.

Your phone can be configured to have a combination of accounts with a single line key and accounts with multiple line keys.

## Dial Plan

Dial plan is a string of characters that governs the way your SIP-T48G IP phone processes the inputs received from your phone keypad. The SIP-T48G IP phone supports the following dial plan features:

- [Replace Rule](#)
- [Dial-now](#)
- [Area Code](#)
- [Block Out](#)

Basic expression syntaxes you need to know:

Syntax	Description
.	The dot "." can be used as a placeholder or multiple placeholders for any character. Example: "12." would match "123", "1234", "12345", "12abc", etc.
x	An "x" can be used as a placeholder for any character. Example: "12x" would match "121", "122", "123", "12a", etc.
[]	The square brackets "[]" can be used as a placeholder for a single character which matches any of a set of characters. Example: "91[5-7]1234" would match "9151234", "9161234", "9171234".
()	The parentheses "( )" can be used to group together patterns, for instance, to logically combine two or more patterns. Example: "([1-9])([2-7])3" would match "923", "153", "773", etc.

Syntax	Description
\$	<p>The "\$" should be followed by the sequence number of a parenthesis. The "\$" plus the sequence number means the whole character or characters placed in the parenthesis. The number directs to the right parenthesis when there are more than one. Example:</p> <p>A replace rule configuration, Prefix: "001(xxx)45(xx)", Replace: "9001\$145\$2". When you dial out "0012354599" on your phone, the IP phone will replace the number with "9001<b>235</b>45<b>99</b>". "\$1" means 3 digits in the first parenthesis, that is, "235". "\$2" means 2 digits in the second parenthesis, that is, "99".</p>

**Note** Dial plan is configurable via web user interface only.

## Replace Rule

You can configure one or more replace rules (up to 100) to remove the specified string and replace it with another string. You can configure a pattern with wildcards (refer to the expression syntax in the table above), so that any string that matches the pattern will be replaced. This feature is convenient for you to dial out a long number. For example, a replace rule is configured as "Prefix: 1" and "Replace: 1234", when you try to dial out the number "1234", you just need to enter "1" on the phone and then tap the Send soft key.

**To add a replace rule via web user interface:**

1. Click on **Settings->Dial Plan->Replace Rule**.
2. Enter the string (e.g., 1) in the **Prefix** field.
3. Enter the string (e.g., 1234) in the **Replace** field.
4. Enter the desired line ID in the **Account** field or leave it blank.

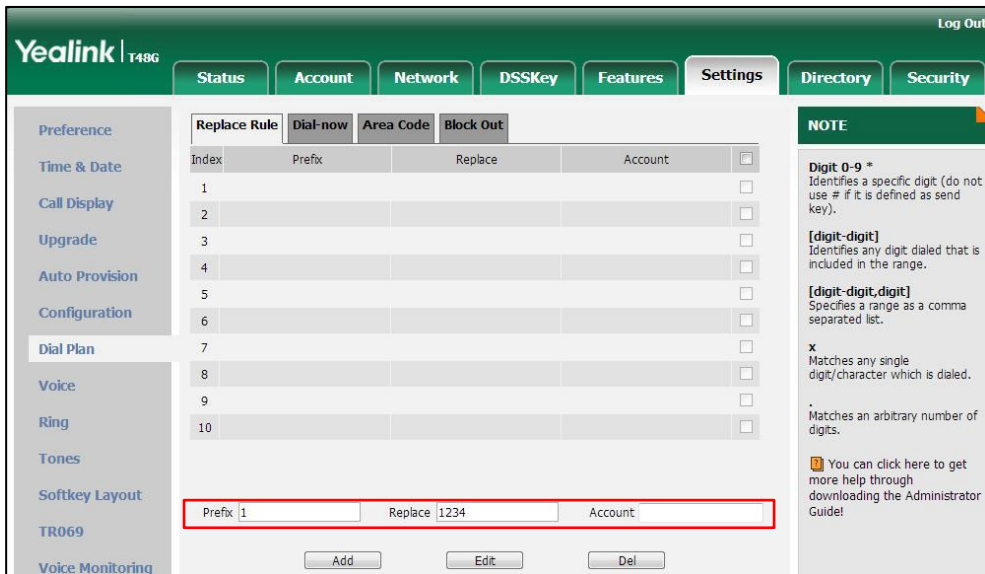

5. Click **Add** to add the replace rule.

When you enter the number "1" using the keypad and then tap the **Send** soft key, the phone will dial out "1234" instead.

**Note**

The valid values for the **Account** field can be one or more digits among 1-16. Every two digits must be separated by a comma. For example, when you enter the value "1, 2" in the **Account** field, this replace rule will apply to account1 and account2.

If you leave the **Account** field blank or enter 0, the replace rule will apply to all accounts.

**To edit a replace rule via web user interface:**

1. Click on **Settings->Dial Plan->Replace Rule**.
2. Select the desired replace rule by checking the checkbox.
3. Edit the values in the **Prefix** and **Replace** fields.
4. Enter the desired line ID in the **Account** field or leave it blank.
5. Click **Edit** to accept the change.

**To delete one or more replace rules via web user interface:**

1. Click on **Settings->Dial Plan->Replace Rule**.
2. Select one or more replace rules by checking the checkbox(es).
3. Click **Del** to delete the replace rule(s).

## Dial-now

You can configure one or more dial-now rules (up to 100) on your phone. When the dialed number matches the dial-now string, the number will be dialed out automatically. For example, a dial-now rule is configured as "2xx", any entered three-digit string beginning with 2 will then be dialed out automatically on the phone.

**To add a dial-now rule via web user interface:**

1. Click on **Settings->Dial Plan->Dial-now**.
2. Enter the desired value (e.g., 2xx) in the **Rule** field.
3. Enter the desired line ID in the **Account** field or leave it blank.

For more information on the valid values for the **Account** field, refer to [Replace Rule](#) on page 88.

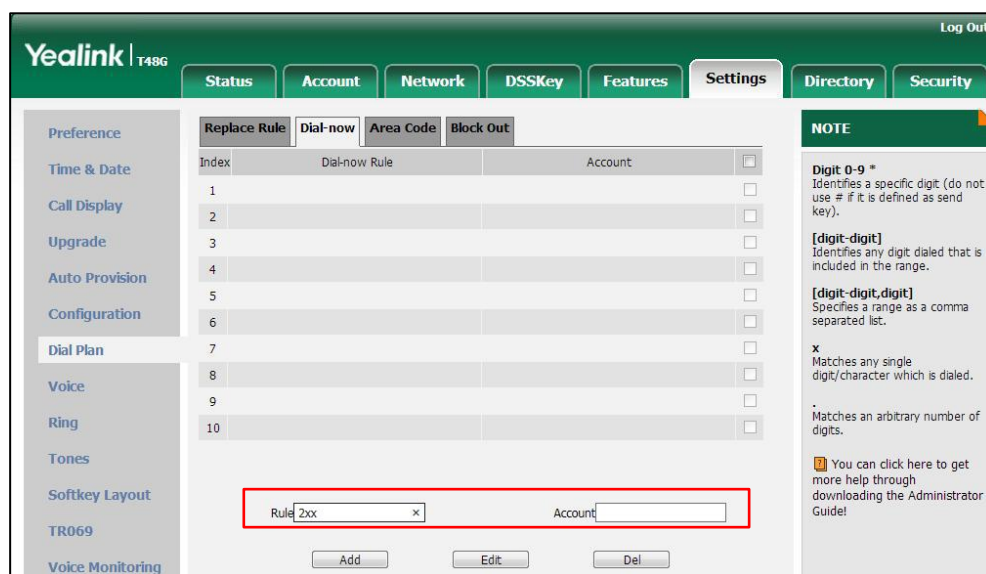

4. Click **Add** to add the dial-now rule.

When you enter the number “234” using the keypad, the phone will dial out “234” automatically without the pressing of any key.

#### Note

You can also edit or delete the dial-now rule, refer to [Replace Rule](#) on page 88 for more information.

### Delay Time for Dial-Now Rule

You can configure the delay time for dial-now rules. That is, you can configure your phone to automatically dial out the phone number which matches a dial-now rule, after the designated delay time.

**To configure the delay time for dial-now rule via web user interface:**

1. Click on **Features->General Information**.

- Enter the time between 1 and 14 (seconds) in the **Time-Out for Dial-Now Rule** field. The default value is 1.

The screenshot shows the Yealink T48G web interface with the 'Features' tab selected. The 'General Information' section is expanded, and the 'Time-Out for Dial-Now Rule' field is highlighted with a red box. The field contains the value '1'. Other fields in the section include Call Waiting (Enabled), Auto Redial (Disabled), Auto Redial Interval (10), Auto Redial Times (10), Key As Send (#), Reserve # in User Name (Enabled), Hotline Number, Hotline Delay (4), Busy Tone Delay (0), Return Code When Refuse (486), Return Code When DND (480), Call Completion (Disabled), and Feature Key Synchronization (Enabled). A 'NOTE' section on the right provides information about Call Waiting, Key As Send, and Hotline Number features.

- Click **Confirm** to accept the change.

#### Note

Delay time for dial-now rule is configurable via web user interface only.

## Area Code

Area codes are also known as Numbering Plan Areas (NPAs). They usually indicate geographical areas in a country. This feature is necessary when dialing a phone number outside the code area. For example, an area code is configured as "Code: 0592, Min Length: 1, Max Length: 15". When you dial out the number "56789" (the length of the number is between 1 and 15), the phone will add the area code and dial out the number "059256789". You can only configure one area code rule on your phone.

**To configure the area code and lengths via web user interface:**

- Click on **Settings->Dial Plan->Area Code**.
- Enter the desired values in the **Code**, **Min Length (1-15)** and **Max Length (1-15)** fields.
- Enter the desired line ID in the **Account** field or leave it blank.

For more information on the valid values for the **Account** field, refer to [Replace Rule](#) on page 88.

4. Click **Confirm** to accept the change.

**Note** The default values of minimum and maximum length are 1 and 15 respectively.

## Block Out

You can block some specific numbers (up to 10) from being dialed on your phone. When you dial a block out number on your phone, the dialing will fail and the touch screen will prompt "Forbidden Number".

**To add a block out number via web user interface:**

1. Click on **Settings->Dial Plan->Block Out**.
2. Enter the desired value in the **BlockOut Number** field.
3. Enter the desired line ID in the **Account** field or leave it blank.

For more information on the valid values for the **Account** field, refer to [Replace Rule](#) on page 88.

Block Out Number	Account
Block Out Number1	Account
Block Out Number2	Account
Block Out Number3	Account
Block Out Number4	Account
Block Out Number5	Account
Block Out Number6	Account
Block Out Number7	Account
Block Out Number8	Account
Block Out Number9	Account
Block Out Number10	Account

**NOTE**

**Digit 0-9 \***  
Identifies a specific digit (do not use # if it is defined as send key).

**[digit-digit]**  
Identifies any digit dialed that is included in the range.

**[digit-digit,digit]**  
Specifies a range as a comma separated list.

**x**  
Matches any single digit/character which is dialed.

**.**  
Matches an arbitrary number of digits.

You can click here to get more help through downloading the Administrator Guide!

4. Click **Confirm** to add the block out number.

## Live Dialpad

You can enable live dialpad on the SIP-T48G IP phone, which enables the IP phone to automatically dial out a phone number without the pressing of the send key. You can also configure a delay, where the phone will dial out the phone number automatically after the designated period of time.

**To enable the live dialpad via web user interface:**

1. Click on **Settings->Preference**.
2. Select **Enabled** from the pull-down list of **Live Dialpad**.

3. Enter the desired delay time in the **Inter Digit Time (1~14s)** field.

The default delay time is 4s.

The screenshot shows the Yealink T48G web interface. The 'Settings' tab is active. The 'Inter Digit Time(1~14s)' field is highlighted with a red box, showing a value of 4. Other settings include Language (English), Live Dialpad (Enabled), Backlight Active Level (Low), Backlight Inactive Level (8), Backlight Time (Always On), Watch Dog (Disabled), Ring Type (Ring1.wav), and Upload Ringtone/Wallpaper options. A 'Confirm' button is visible at the bottom of the settings area.

4. Click **Confirm** to accept the change.

**Note** Live dialpad is configurable via web user interface only.

## Hotline

You can dial a hotline number immediately upon lifting the handset, pressing the speakerphone key or tapping the line key. You can also configure a delay, where the phone will dial out the hotline number automatically after a designated period of time.

**To configure the hotline number via phone user interface:**

1. Tap  -> **Features**-> **Hot Line**.
2. Enter the desired number in the **Number** field.



3. Enter the desired delay time in the **HotLine Delay** field.

The valid values range from 0 to 10s.

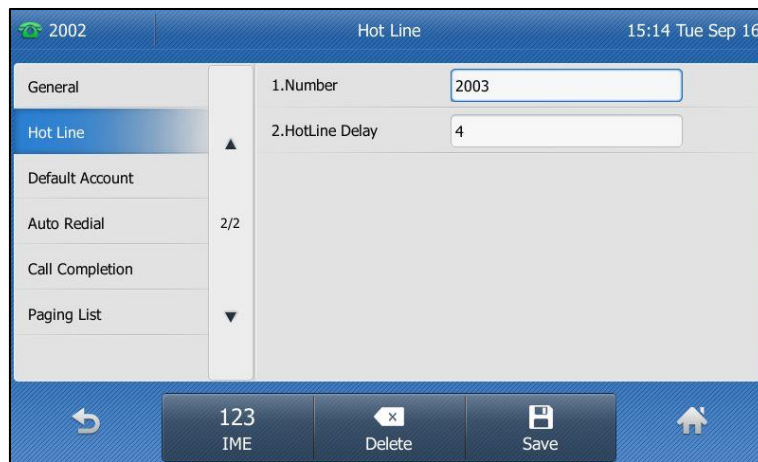

4. Tap the **Save** soft key to accept the change or  to cancel.

Hotline is configurable via web user interface at the path **Features->General Information**.



## Basic Call Features

---

The SIP-T48G IP phone is designed to be easily used like a regular phone on a public switched telephone network (PSTN). You can place calls, answer calls, transfer a call to someone else, or conduct a conference call.

This chapter provides basic operating instructions for the SIP-T48G IP phone. Topics include:

- [Placing Calls](#)
- [Answering Calls](#)
- [Ending Calls](#)
- [Redialing Numbers](#)
- [Recent Call In Dialing](#)
- [Auto Answer](#)
- [Auto Redial](#)
- [Call Completion](#)
- [Recall](#)
- [Call Mute](#)
- [Call Hold/Resume](#)
- [Do Not Disturb \(DND\)](#)
- [Call Forward](#)
- [Call Transfer](#)
- [Call Waiting](#)
- [Conference](#)
- [Call Park](#)
- [Call Pickup](#)
- [Anonymous Call](#)
- [Anonymous Call Rejection](#)

If you require additional information or assistance with your new phone, contact your system administrator.

## Placing Calls

You can place a call in one of three ways using your SIP-T48G IP phone:

- Using the handset
- Using the speakerphone
- Using the headset

You can also dial the number first, and then choose the way you want to speak to the other party.

You can also dial an entry/contact from call history, local directory or remote phone book. For more information, refer to [Contact Management](#) on page 36 and [Call History Management](#) on page 61.

During a call, you can alternate between Speakerphone, Headset, and Handset modes by pressing the Speakerphone key, the HEADSET key, or by picking up the handset.

The call duration of the call is visible on the touch screen. In the figure below, the call to “1006” has lasted 6 seconds.

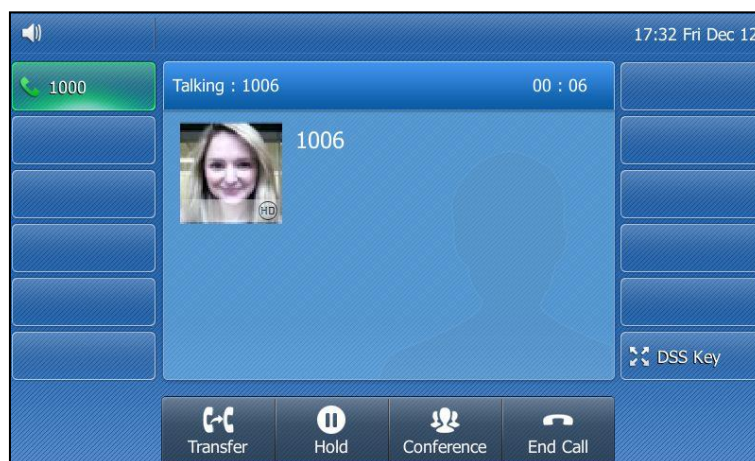



### To place a call using the handset:

1. Pick up the handset.
2. Enter the desired number using the keypad.

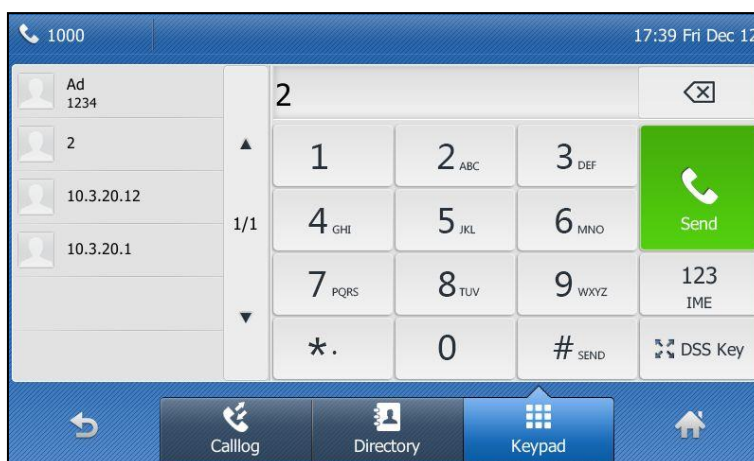
You can enter the number using the keypad displayed on the touch screen.



3. Press  ,  , or tap the **Send** soft key.

The # key is configured as a send key by default. You can also set the \* key as the send key, or set neither. For more information, refer to the [Key as Send](#) on page 33.

You can also tap the **Calllog** soft key or the **Directory** soft key to search for an entry or contact after picking up the handset, and then tap the desired entry or contact to place a call.







#### Note

You can also dial using the SIP URI or IP address. To obtain the IP address of a phone, press the **OK** key when the phone is idle. The maximum SIP URI or IP address length is 32 characters. For example, SIP URI: 3606@sip.com, IP: 192.168.1.15.

Your phone may not support direct IP dialing. Contact your system administrator for more information.

#### To place a call using the hands-free speakerphone mode:



Do one of the following:



- With the handset on-hook, press  or tap the line key to obtain a dial tone.  
Enter the desired number using the keypad or the on-screen keypad.  
Press  ,  or tap the **Send** soft key.
- With the handset on-hook, enter the desired number using the keypad.  
Press  ,  ,  or tap the **Send** soft key.

#### To place a call using the headset:

Do one of the following:

- With the optional headset connected, press  to activate the headset mode.  
Tap the line key to obtain a dial tone.  
Enter the desired number using the keypad or the on-screen keypad.

Press  ,  , or tap the **Send** soft key.





- With the optional headset connected, press  to activate the headset mode. Enter the desired number using the keypad. Press  ,  , or tap the **Send** soft key.

**Note** To permanently use the headset mode, refer to [Headset Prior](#) on page 65.

The SIP-T48G IP phone can handle multiple calls at a time. However, only one active call (the call that has audio associated with it) can be in progress at any given time. The SIP-T48G IP phone can handle a maximum of 6 calls at one time.

#### To place multiple calls:

You can have more than one call on your SIP-T48G IP phone. To place a new call during an active call, do one of the following:

- Tap the line key. The active call is placed on hold. Enter the desired number using the keypad or the on-screen keypad. Press  ,  , or tap the **Send** soft key.
- Press  or tap the **Hold** soft key to place the original call on hold. Tap the **New Call** soft key. Enter the desired number using the keypad or the on-screen keypad. Press  ,  , or tap the **Send** soft key.

You can tap the desired call, and then tap the **Resume** soft key to retrieve it.

**Note** If multiple accounts are registered on the phone, you can first tap the desired line key in the idle screen or tap the desired line from the status bar in dialing screen, and then you can use the selected account to place a call.

## Answering Calls

When you are not in another call, you can answer a call in one of three ways:

- Using the handset
- Using the speakerphone
- Using the headset

**Note** You can reject incoming calls by pressing the **X** key or tapping the **Reject** soft key to stop the phone from playing ring tone. You can also activate the Do Not Disturb mode to reject the incoming calls without ringing on your phone. For more information, refer to [Do Not Disturb \(DND\)](#) on page 110.

You can forward incoming calls to someone else by tapping the **Forward** soft key. For more information, refer to [Call Forward](#) on page 115.

### Answering When Not in Another Call

Call duration and destination will always appear on the touch screen for the active call.

#### To answer a call using the handset:

1. Pick up the handset.

#### To answer a call using the hands-free speakerphone mode:

Do one of the following:

- Press  .
- With the handset on-hook and the headset mode deactivated, tap the **Answer** soft key.
- With the handset on-hook and the headset mode deactivated, tap the line key (the line key illuminates green).

#### To answer a call using the headset:

Do one of the following:

- Press  .
- With the headset mode activated, tap the **Answer** soft key.
- With the headset mode activated, tap the line key (the line key illuminates green).

### Answering When in Another Call

If you have an active call, and an incoming call arrives on the phone. The incoming call information is displayed on the touch screen.



1. Press  or tap the **Answer** soft key.  
The incoming call is answered and the original call is placed on hold.

## Ending Calls

### To end a call:

Do one of the following:

- If you are using the handset, tap the **End Call** soft key or hang up the handset.
- If you are using the headset, tap the **End Call** soft key.
- If you are using the speakerphone, press  or tap the **End Call** soft key.

### Note

To end a call placed on hold, you can tap the **End Call** soft key to end the call directly, or tap the **Resume** soft key to resume the call before ending it.

## Redialing Numbers

### To redial the last dialed number from your phone:

1. Press  twice.

A call to your last dialed number is attempted.

### To redial a previously dialed number from your phone:

1. Press  when the phone is idle.
2. Tap the desired entry from the placed calls list.

## Recent Call In Dialing

To view the placed calls list when the phone is in the pre-dialing interface, you should enable recent call in dialing in advance.

### To enable recent call in dialing via web user interface:

1. Click on **Directory->Setting**.



2. Select **Enabled** from the pull-down list of **Recent Call In Dialing**.

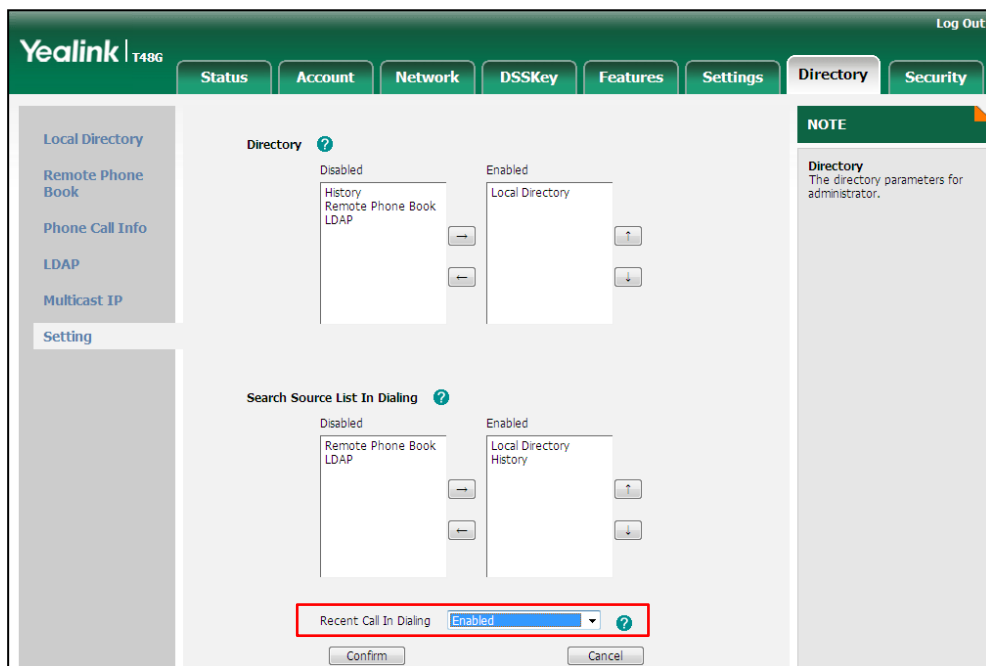

3. Click **Confirm** to accept the change.

#### Note

Recent call in dialing is configurable via web user interface only.

To view placed calls list when the phone is in the pre-dialing interface:

1. Pick up the handset, press the speakerphone key or tap the line key.  
The touch screen displays the placed calls list.



You can tap ▲ or ▼ to scroll through placed calls page by page.

## Auto Answer

You can use auto answer to automatically answer an incoming call on a line. Auto answer is configurable on a per-line basis.

To configure auto answer via phone user interface:

1. Tap  -> **Features**->**Auto Answer**.
2. Tap the **On** radio box of the desired line.

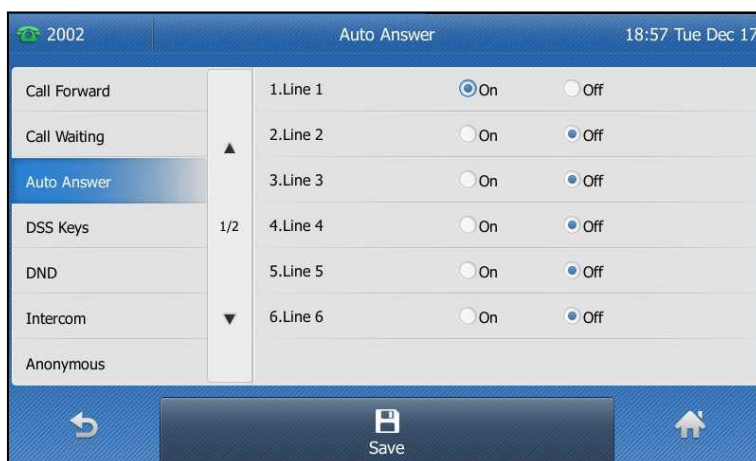

3. Tap the **Save** soft key to accept the change or  to cancel.

The  icon appears on the touch screen.



Auto answer is configurable via web user interface at the path **Account**->**Basic**.

### Note

Auto answer is only applicable when there is no other call in progress on the phone.

## Auto Redial

You can enable auto redial to automatically redial a phone number when the called party is busy. You can also configure the number of auto redial attempts and the time to wait between redial attempts.

**To configure auto redial via phone user interface:**

1. Tap  -> **Features**->**Auto Redial**.
2. Tap the **On** radio box of the **Auto Redial** field.
3. Enter the desired time (in seconds) in the **Redial Interval** field.  
The default time interval is 10 seconds.
4. Enter the desired number of redial attempts in the **Redial Times** field.  
The default value is 10.

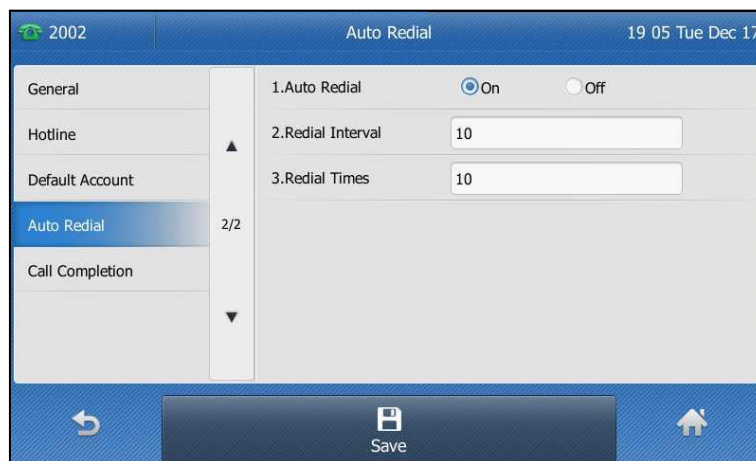

5. Tap the **Save** soft key to accept the change or  to cancel.

Auto redial is configurable via web user interface at the path **Features->General Information**.

**To use auto redial:**

When the called party is busy, the touch screen prompts the following:



1. Tap the **OK** soft key to activate auto redial.

The touch screen prompts the following:



2. Wait for the designated period of time or tap the **OK** soft key to redial the phone number.

The phone will retry as many times as configured until the called party is idle.

## Call Completion

You can use call completion to notify the caller who failed to reach a desired party when the party becomes available to receive a call.

**To enable call completion via phone user interface:**

1. Tap  -> **Features**-> **Call Completion**.

2. Tap the **On** radio box of the **Call Completion** field.

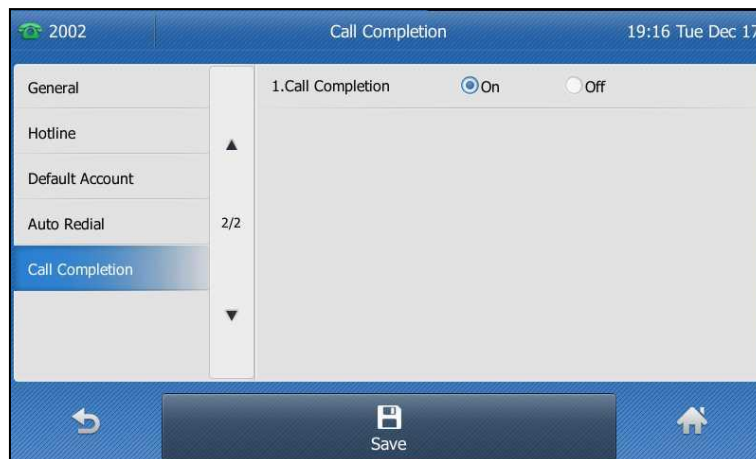

3. Tap the **Save** soft key to accept the change or  to cancel.

Call completion is configurable via web user interface at the path **Features->General Information**.

**To use call completion:**

When the called party is busy, the following prompt will appear on the touch screen of the phone:

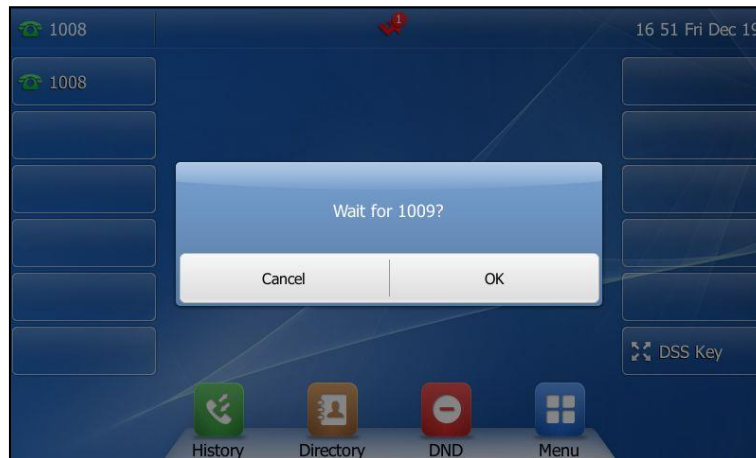

1. Tap the **OK** soft key, the phone will then returns to the idle screen and call completion will be activated.

2. When the called party becomes idle, the touch screen prompts the following:

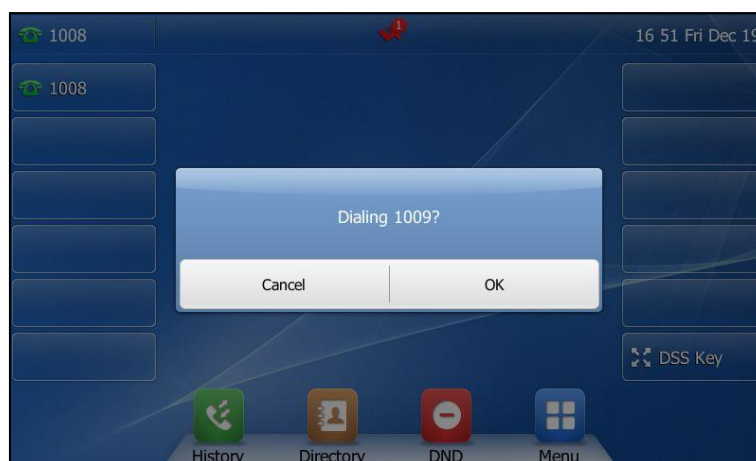

3. Tap the **OK** soft key to redial the number.

**Note**

Call completion is not available on all servers. For more information, contact your system administrator.

## Recall

You can tap a recall key to place a call back to the last incoming call.

**To configure a recall key via phone user interface:**

1. Tap **DSS Key**.
2. Tap the desired line key.
3. Tap the gray box of the **Type** field.
4. Tap **Key Event** from the pull-down list.
5. Tap the gray box of the **Key Type** field.
6. Tap **ReCall** from the pull-down list.

- (Optional.) Enter a label that will appear on the touch screen in the **Label** field.



- Tap the **Save** soft key to accept the change or  to cancel.
- Tap **DSS Key** to return to the idle screen.

Recall key is configurable via web user interface at the path **DSSKey->Line key**.

## Call Mute

You can mute the microphone of the active audio device during an active call so that the other party cannot hear you. Call mute applies to all modes (Handset, Headset and Speakerphone).

### To mute a call:

- Press  during an active call.

The touch screen indicates that the call is muted. The mute key LED illuminates solid red when the call is muted.

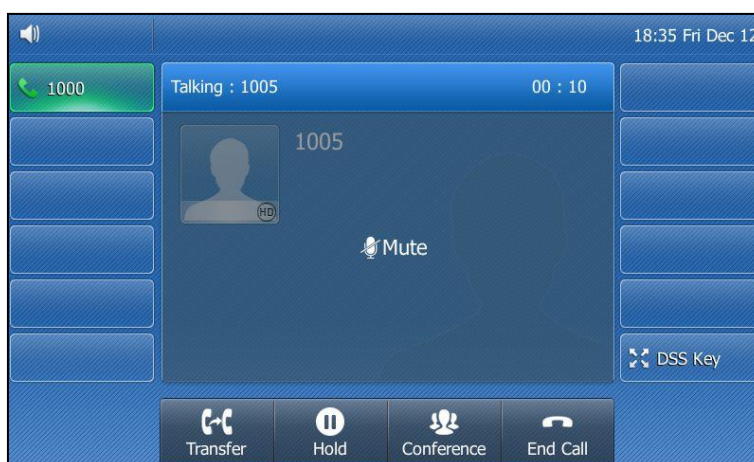

**To un-mute a call:**

1. Press  again to un-mute the call.

## Call Hold/Resume

You can place an active call on hold. Only one active call can be in progress on the phone at any time. Other calls can be made and received while placing the original call on hold. When you place a call on hold, your IP PBX may play music to the other party while waiting.

**To place a call on hold:**

1. Press  or tap the **Hold** soft key during a call.  
The touch screen indicates that the call is on hold.

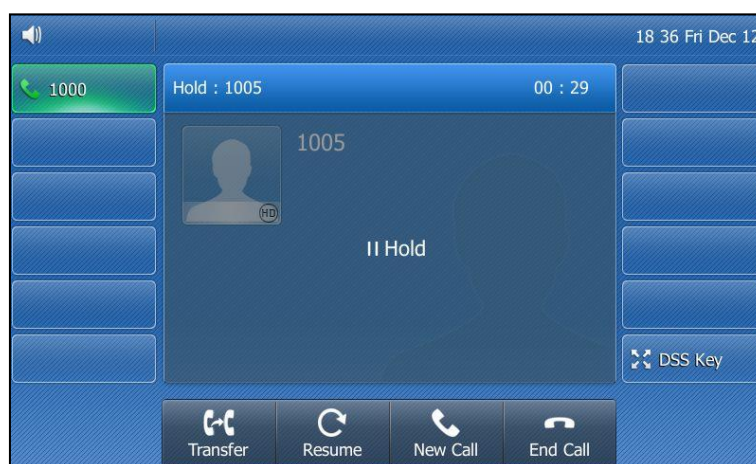

The phone will beep softly every 30 seconds to remind you that you still have a call on hold.

**To resume a held call:**

1. Press  or tap the **Resume** soft key.

**Multiple Calls on Hold:**

If multiple calls are placed on hold, do one of the following:

- Tap the desired call, and then tap the **Resume** soft key to retrieve it.
- Tap the desired call, and then tap the corresponding line key to retrieve it.

## Do Not Disturb (DND)

You can use DND to reject incoming calls automatically on the phone. The prompt message "**n New Missed Call(s)**" ("n" indicates the number of missed calls) will appear on the touch screen, and callers will receive a busy message. All calls you receive while



DND is enabled are logged to your missed calls list.

### Note

The prompt message will display only if Missed Call Log for the line is enabled. Missed call log is configurable via web user interface at the path **Account->Basic->Miss Call Log**.

Do not disturb is local to the phone, and may be overridden by the server settings. For more information, contact your system administrator.

You can enable/disable DND for the phone system, or you can customize DND for each or all accounts. Two DND modes:

- **Phone** (default): DND is effective for the phone system.
- **Custom**: DND can be configured for each or all accounts.

You can receive incoming calls from authorized numbers when DND is enabled.

To configure the DND mode via web user interface:

1. Click on **Features->Forward & DND**.
2. In the **DND** block, mark the desired radio box in the **Mode** field.

The screenshot shows the Yealink T48G web user interface. The 'Features' tab is selected, and the 'Forward & DND' section is active. The 'DND' block is highlighted with a red box, showing the 'Mode' field set to 'Phone' (selected) and 'Custom' (unselected). Other fields in the 'DND' block include 'Account' (2002), 'DND Status' (Off), 'DND On Code', and 'DND Off Code'. The 'Forward' section includes 'Always Forward' and 'Busy Forward' options, each with 'On' and 'Off' radio buttons and 'Target', 'On Code', and 'Off Code' input fields. The 'No Answer Forward' section includes an 'After Ring Time' dropdown set to 12, and 'Target', 'On Code', and 'Off Code' input fields. A 'NOTE' panel on the right provides definitions for 'Forward', 'Target', 'On Code', and 'Off Code'. The 'Confirm' and 'Cancel' buttons are at the bottom.

3. Click **Confirm** to accept the change.

### Note

DND mode is configurable via web user interface only.

**To activate DND in phone mode:**

1. Tap .

The  icon on the status bar indicates that DND is enabled.

Incoming calls will be rejected automatically and "n New Missed Call(s)" ("n" indicates the number of missed calls) will appear on the touch screen.

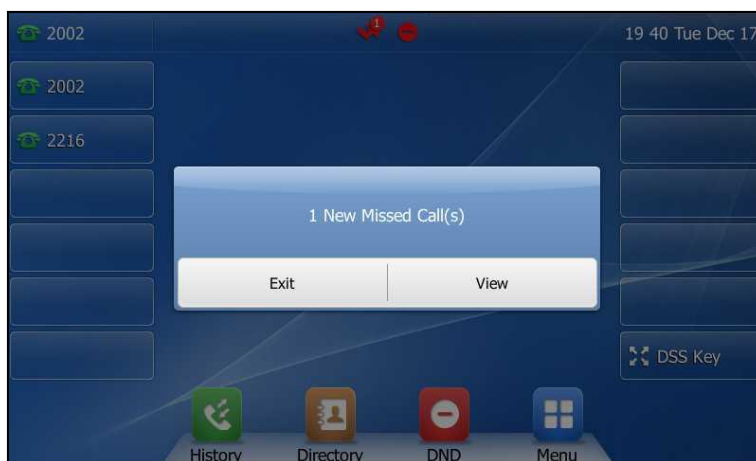

**Note**

When DND and busy forward are enabled in phone mode, calls will be sent to the configured destination number. For more information on busy forward, refer to [Call Forward](#) on page 115.

**To activate DND in custom mode for a specific account:**

1. Tap .

The touch screen displays a list of accounts registered on the phone.



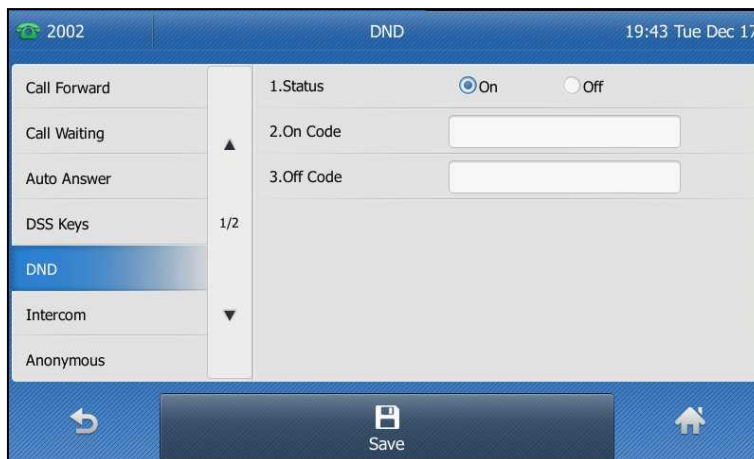

2. Tap the desired account.

3. Tap the **On** radio box of the **Status** field.



4. Tap the **Save** soft key to accept the change.

If you activate DND for the default account, the associated line icon will change to , and the  icon will appear on the status bar.

If you activate DND for the non-default account, only the associated line icon will change to .

Incoming calls on the specific line will be rejected automatically, and the touch screen will prompt "**n New Missed Call(s)**" ("n" indicates the number of missed calls).

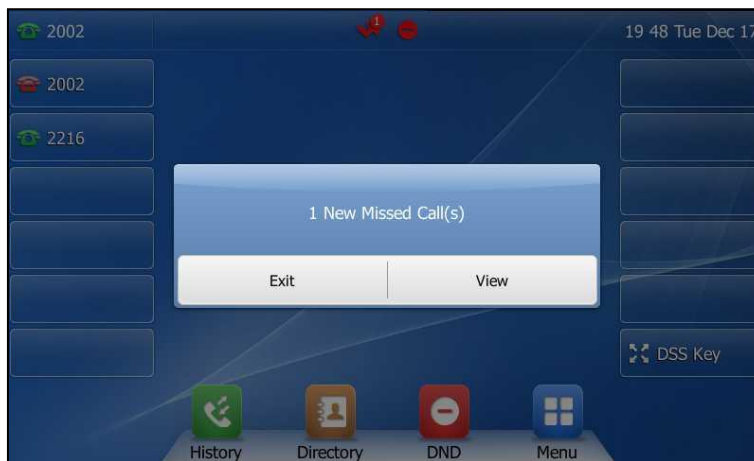

#### Note

When DND and busy forward are enabled for a specific account, calls from the specific account will be sent to the configured destination number. For more information on busy forward, refer to [\\_Call Forward\\_](#) on page 115.

To activate DND in custom mode for all accounts:

1. Tap .

The touch screen displays a list of accounts registered on the phone.

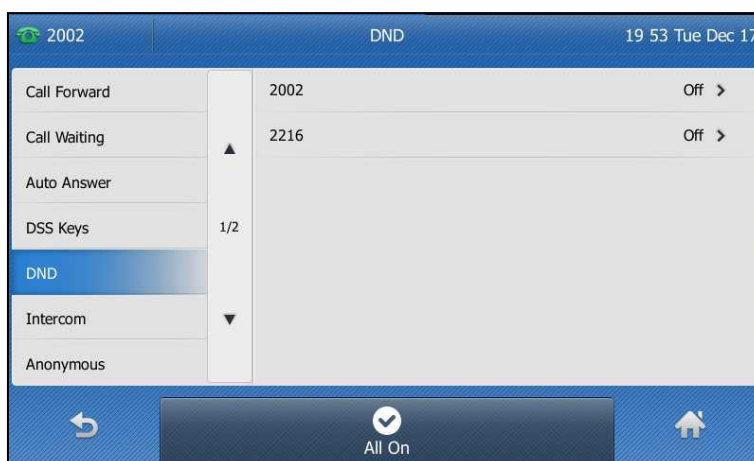

2. Tap the **All On** soft key to activate DND for all accounts.
3. Tap  to return to the idle screen.

The  icon appears on the status bar, and all line icons change to .

Incoming calls will be rejected automatically, and the touch screen will prompt "n **New Missed Call(s)**" ("n" indicates the number of the missed calls).

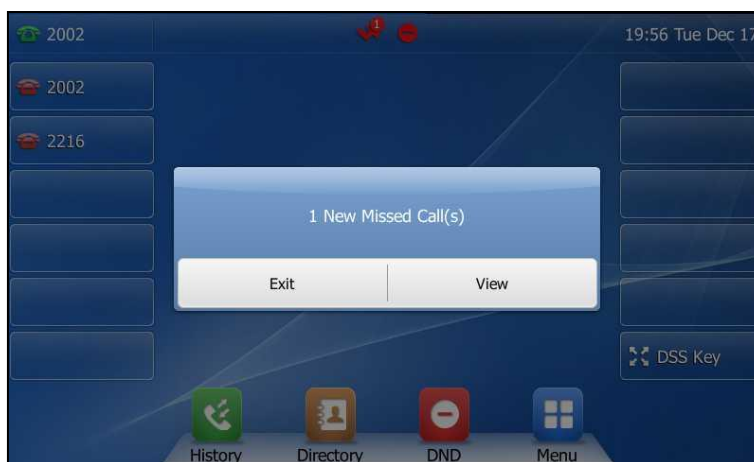

**To configure the DND authorized numbers via web user interface:**

1. Click on **Features->Forward & DND**.
2. Select **Enabled** from the pull-down list of **DND Emergency**.
3. Enter the numbers in the **DND Authorized Numbers** field.

For multiple numbers, enter a comma between every two numbers.

The screenshot shows the Yealink T48G web interface with the 'Features' tab selected. The 'Forward' section is expanded, showing settings for 'Always Forward', 'Busy Forward', and 'No Answer Forward'. Below these, the 'DND' section is highlighted with a red box. In the 'DND' section, 'DND Emergency' is set to 'Enabled' and 'DND Authorized Numbers' is set to '2001,2003'. The 'Forward' section also includes options for 'Mode' (Phone/Custom), 'Account' (2002), and various 'On Code' and 'Off Code' fields for each forwarding mode.

4. Click **Confirm** to accept the change.

When DND is enabled on the phone, the phone can still receive incoming calls from the numbers specified in the **DND Authorized Numbers** field.

#### Note

DND authorized number is configurable via web user interface only.

When the phone receives a voice mail, the voice mail prompt window will pop up by default, if you want to disable the feature, contact your system administrator for more information.

## Call Forward

You can configure your phone to forward incoming calls to another party through the static forwarding. You can also forward calls while your phone is ringing; refer to the dynamic forwarding.

### Static Forwarding

Three types of static forwarding:

- **Always Forward:** Incoming calls are immediately forwarded.
- **Busy Forward:** Incoming calls are immediately forwarded if the phone is busy.

- **No Answer Forward:** Incoming calls are forwarded if not answered after a period of time.

You can enable/disable call forward for the phone system, or you can customize call forward for each or all accounts. Two call forward modes:

- **Phone (default):** Call forward is effective for the phone system.
- **Custom:** Call forward can be configured for each or all accounts.

To configure the call forward mode via web user interface:



1. Click on **Features->Forward & DND**.
2. In the **Forward** block, mark the desired radio box in the **Mode** field.

The screenshot shows the 'Forward & DND' configuration page in the Yealink T48G web interface. The 'Forward' section is highlighted with a red box, showing the 'Mode' field with 'Phone' selected. Other fields include Account (2002), Always Forward (On/Off), Busy Forward (On/Off), No Answer Forward (On/Off), and DND (Emergency, Authorized Numbers, Mode, Account, Status, On Code, Off Code). A 'NOTE' section on the right explains the Forward feature and its codes.

3. Click **Confirm** to accept the change.

**Note** Call forward mode is configurable via web user interface only.

To enable call forward in phone mode:

1. Tap  -> **Features->Call Forward** or press  when the phone is idle.
2. Tap the desired forwarding type.

3. Depending on your selection:

a.) If you tap **Always Forward**:

- 1) Tap the **On** radio box of the **Always Forward** field.
- 2) Enter the destination number you want to forward all incoming calls to in the **Forward to** field.
- 3) (Optional.) Enter the always forward on code or off code respectively in the **On Code** or **Off Code** field.

2002 Always Forward 20:04 Tue Dec 17

Call Forward

1. Always Forward  On  Off

2. Forward to 2003

3. On Code \*71

4. Off Code \*72

123 IME Delete Save

b.) If you tap **Busy Forward**:

- 1) Tap the **On** radio box of the **Busy Forward** field.
- 2) Enter the destination number you want to forward incoming calls to when the phone is busy in the **Forward to** field.
- 3) (Optional.) Enter the busy forward on code or off code respectively in the **On Code** or **Off Code** field.

2002 Busy Forward 20:05 Tue Dec 17

Call Forward

1. Busy Forward  On  Off

2. Forward to 2003

3. On Code \*73

4. Off Code \*74

123 IME Delete Save

c.) If you tap **No Answer Forward**:

- 1) Tap the **On** radio box of the **No Answer Forward** field.
- 2) Enter the destination number you want to forward unanswered incoming

calls to in the **Forward to** field.

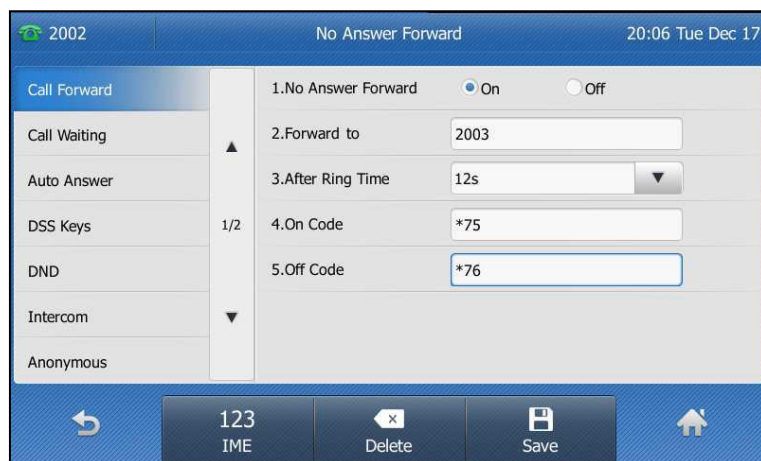

- 3) Tap the gray box of the **After Ring Time** field.
- 4) Tap the desired ring time to wait before forwarding from the pull-down list.  
The default ring time is 12 seconds.
- 5) (Optional.) Enter the no answer forward on code or off code respectively in the **On Code** or **Off Code** field.



4. Tap the **Save** soft key to accept the change.

The  icon on the idle screen indicates that the call forward is enabled.

#### To enable call forward in custom mode:

1. Tap  -> **Features**->**Call Forward** or press  when the phone is idle.  
The touch screen displays a list of accounts registered on the phone.
2. Tap the desired account.
3. Tap the desired forwarding type.
4. Depending on your selection:
  - a.) If you tap **Always Forward**:
    - 1) Tap the **On** radio box of the **Always Forward** field.
    - 2) Enter the destination number you want to forward all incoming calls to in the **Forward to** field.



- 3) (Optional.) Enter the always forward on code or off code respectively in the **On Code** or **Off Code** field.

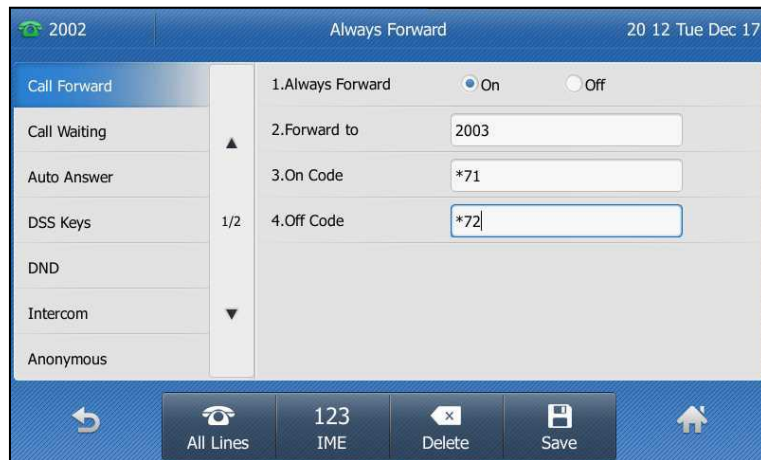

You can also enable always forward for all accounts. Do the following:

- 1) Tap the **All Lines** soft key.

The touch screen prompts "Copy to all lines?".

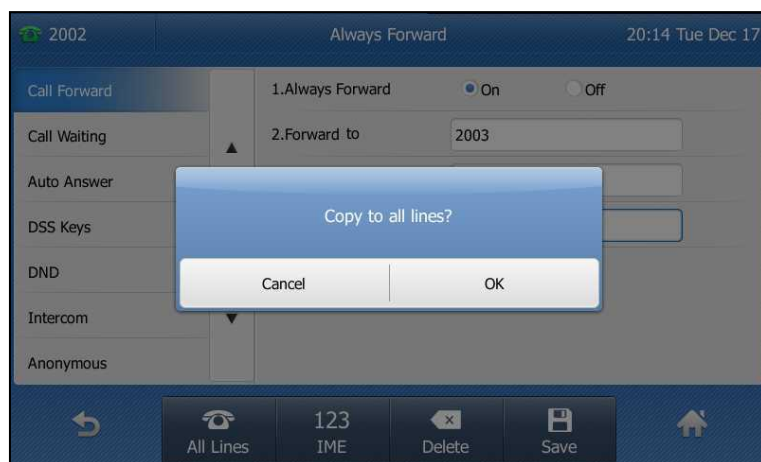

- 2) Tap the **OK** soft key to accept the change or the **Cancel** soft key to cancel.

- b.) If you select **Busy Forward**:

- 1) Tap the **On** radio box of the **Busy Forward** field.
- 2) Enter the destination number you want to forward incoming calls to when the phone is busy in the **Forward to** field.

- 3) (Optional.) Enter the busy forward on code or off code respectively in the **On Code** or **Off Code** field.

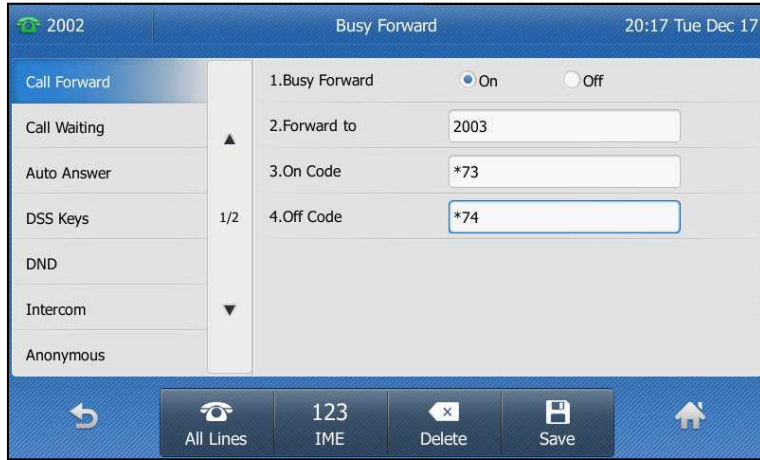

You can also enable busy forward for all accounts. Do the following:

- 1) Tap the **All Lines** soft key.  
The touch screen prompts “Copy to all lines?”.

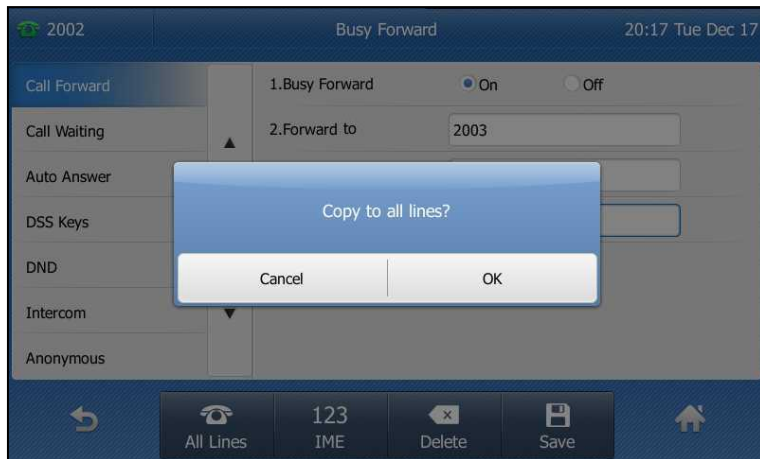

- 2) Tap the **OK** soft key to accept the change or the **Cancel** soft key to cancel.
- c.) If you select **No Answer Forward**:
- 1) Tap the **On** radio box of the **No Answer Forward** field.
  - 2) Enter the destination number you want to forward unanswered incoming calls to in the **Forward to** field.
  - 3) Tap the gray box of the **After Ring Time** field.
  - 4) Tap the desired ring time to wait before forwarding from the pull-down list.  
The default ring time is 12 seconds.

- 5) (Optional.) Enter the no answer forward on code or off code respectively in the **On Code** or **Off Code** field.

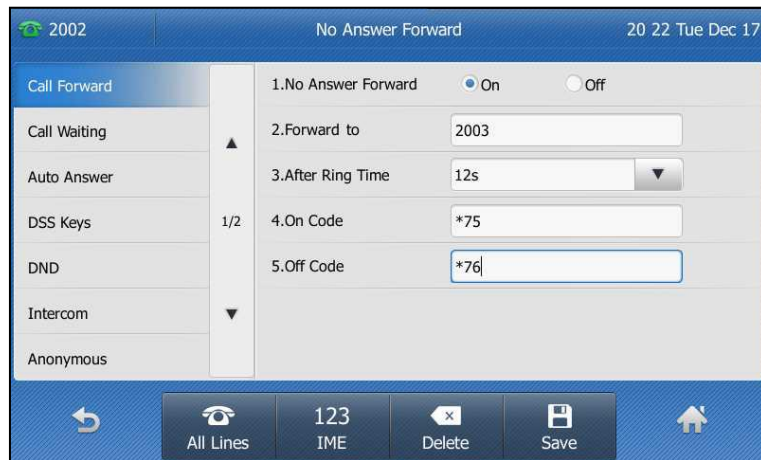



You can also enable no answer forward for all accounts. Do the following:

- 1) Tap the **All Lines** soft key.

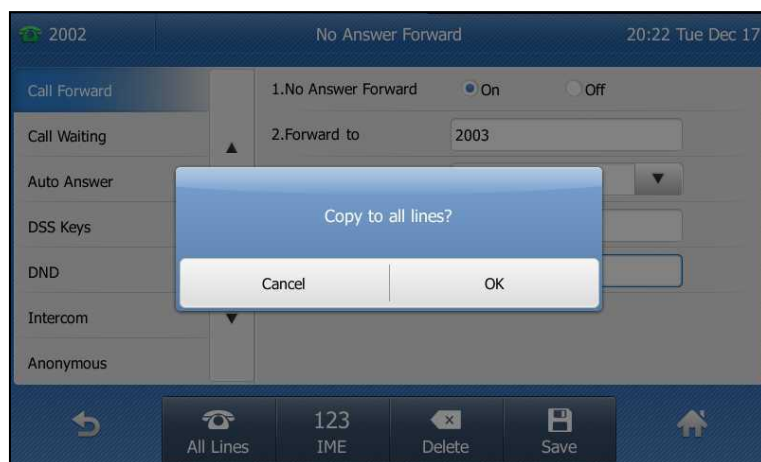
The touch screen prompts “Copy to all lines?”.



- 2) Tap the **OK** soft key to accept the change or the **Cancel** soft key to cancel.
5. Tap the **Save** soft key to accept the change.

If you activate call forward for the default account, the associated line icon will change to , and the  icon will appear on the status bar.

If you activate call forward for the non-default account, only the associated line icon will change to .



Call forward is configurable via web user interface at the path **Features->Forward & DND**.



**Note**

You can also enter the SIP URL or IP address in the **Forward to** field. For more information on using the SIP URL or IP address, refer to [Placing Calls](#) on page 98.



Call forward is local to the phone, and may be overridden by the server settings. Call forward on code or off code may be different among servers. For more information, contact your system administrator.

**To disable call forward in phone mode:**

Do one of the following:

- Press  when the phone is idle.  
You can also tap the forward key to disable call forward directly if a forward key is configured.
- Tap  ->**Features->Call Forward**.  
Tap the desired forwarding type.  
Tap the **Off** radio box.  
Tap the **Save** soft key to accept the change.

**To disable call forward in custom mode for a specific account:**



1. Tap  ->**Features->Call Forward** or press  when the phone is idle.  
The touch screen displays a list of accounts registered on the phone.
2. Tap the desired account.
3. Tap the desired forwarding type.
4. Tap the **Off** radio box.
5. Tap the **Save** soft key to accept the change.

## Dynamic Forwarding

To forward an incoming call to another party:

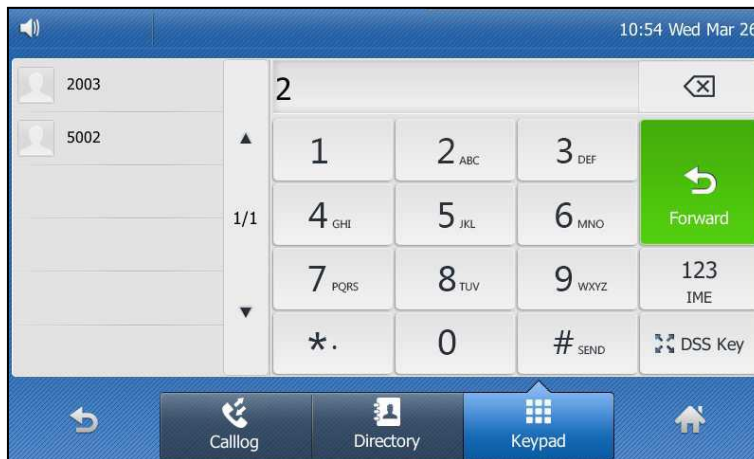
1. When the phone is ringing, tap the **Forward** soft key.
2. Enter the number you want to forward the incoming call to.



3. Press  ,  , or tap the **Forward** soft key.

The touch screen prompts a call forward message.

### Note

When the phone forwards a call, the forward call prompt window will pop up by default, if you want to disable the feature, contact your system administrator for more information.

## Call Transfer

You can transfer a call to another party in one of three ways:

- **Blind Transfer:** Transfer a call directly to another party without consulting.
- **Semi-Attended Transfer:** Transfer a call when the target phone is ringing.
- **Attended Transfer:** Transfer a call with prior consulting.

To perform a blind transfer:





1. Press  or tap the **Transfer** soft key during a call.

2. Enter the number you want to transfer the call to.





3. Press  or tap the **Transfer** soft key to complete the transfer.  
The call is then connected to the number to which you are transferring.

**To perform a semi-attended transfer:**

1. Press  or tap the **Transfer** soft key during a call.
2. Do one of the following:
  - Enter the number you want to transfer the call to, and then press  or  to dial out.
  - Tap the **Directory** soft key, and then tap **All Contacts**. Search for the contact and tap the desired contact to dial out. (Directory should be configured in advance. Refer to [Directory](#) on page 37 for more information.)
  - Tap the **Directory** soft key, and then tap **Remote Phone Book**. Search for the contact and tap the desired contact to dial out. (Directory and remote phone book should be configured in advance. Refer to [Directory](#) on page 37 and [Remote Phone Book](#) on page 58 for more information.)
  - Tap the **History** soft key, and then tap the desired list. Tap the desired entry to dial out.
3. Press  or tap the **Transfer** soft key to complete the transfer when receiving ringback.

**To perform an attended transfer:**

1. Press  or tap the **Transfer** soft key during a call.
2. Do one of the following:
  - Enter the number you want to transfer the call to, and then press  or  to dial out.
  - Tap the **Directory** soft key, and then tap **All Contacts**. Search for the contact and tap the desired contact to dial out. (Directory should be configured in

advance. Refer to [Directory](#) on page 37 for more information.)

- Tap the **Directory** soft key, and then tap **Remote Phone Book**. Search for the contact and tap the desired contact to dial out. (Directory and remote phone book should be configured in advance. Refer to [Directory](#) on page 37 and [Remote Phone Book](#) on page 58 for more information.)
  - Tap the **History** soft key, and then tap the desired list. Tap the desired entry to dial out.
3. After the party answers the call, press  or tap the **Transfer** soft key to complete the transfer.

If you are using a handset, the transfer can be completed by hanging up the handset.

## Call Waiting

You can enable or disable call waiting on the phone. If call waiting is enabled, you can receive another call when there is already an active call on the phone. Otherwise, another incoming call is automatically rejected by the phone with a busy message when there is an active call on the phone. You can also enable or disable the phone to play a warning tone when receiving another call.

**To configure call waiting via phone user interface:**

1. Tap  -> **Features**->**Call Waiting**.
2. Tap the **On** radio box of the **Call Waiting** field.
3. Tap the **On** radio box of the **Play Tone** field.
4. (Optional.) Enter the call waiting on code or off code respectively in the **On Code** or **Off Code** field.



5. Tap the **Save** soft key to accept the change or  to cancel.

Call waiting is configurable via web user interface at the path **Features**->**General Information**.

## Conference

You can use the SIP-T48G IP phone to create a conference with other two parties using the phone's local conference or create a conference with multiple participants which is called network conference.

### Note

Network conference is not available on all servers. For more information, contact your system administrator.

## Local Conference

The SIP-T48G IP phone supports up to 3 parties (including yourself) in a conference call. This is the default method of conference called Local Conference. You can create a conference between an active call and a call on hold at any time by tapping the Conference soft key.

### To set up a local conference call:

1. Place a call to the first party.
2. When the first party answers the call, tap the **Conference** soft key to place a new call.

The active call is placed on hold.

3. Enter the number of the second party, and then press **OK** , **#SEND** , or tap the **Conference** soft key.
4. When the second party answers the call, tap the **Conference** soft key again to join all parties in the conference.

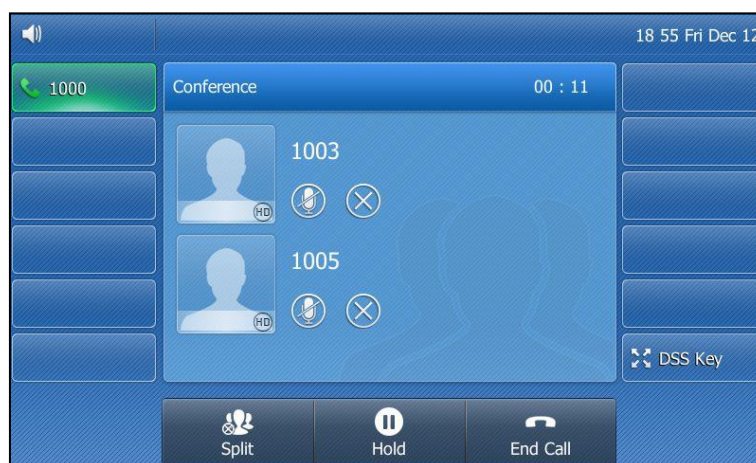

### To join two calls in a conference:





1. Place two calls using two different accounts on the phone (for example, place the first call using account 1, and then place the second call using account 2).

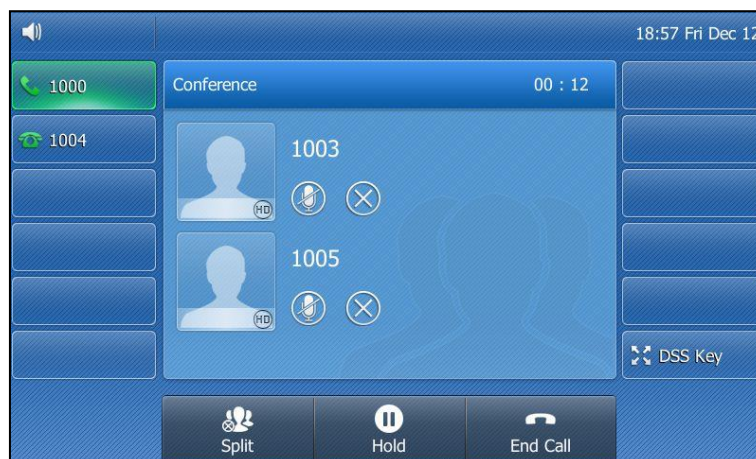

2. Tap the desired call for conference and ensure that the call is active (for example, tap the call on account 1).
3. Tap the **Conference** soft key to join the two calls in the conference on the selected account.



**During the conference call, you can do the following actions:**

- Press  or tap the **Hold** soft key to place the conference call on hold.
- Tap the **Split** soft key to split the conference call into two individual calls on hold.
- Tap  to remove the desired party.
- Press  to mute the conference call.
- Tap  to forbid the desired party from speaking. The muted party can hear everyone, but no one can hear the muted party.
- Tap the **End Call** soft key to drop the conference call.

## Network Conference

You can use network conference feature on the SIP-T48G IP phone to conduct a conference with multiple participants.

This feature allows you to perform the following:

- Join two calls together into a conference call.
- Invite another party into an active conference call.

To use this feature, contact your system administrator for the network conference URI in advance.

**To configure network conference via web user interface:**

1. Click on **Account->Advanced**.
2. Select **Network Conference** from the pull-down list of **Conference Type**.



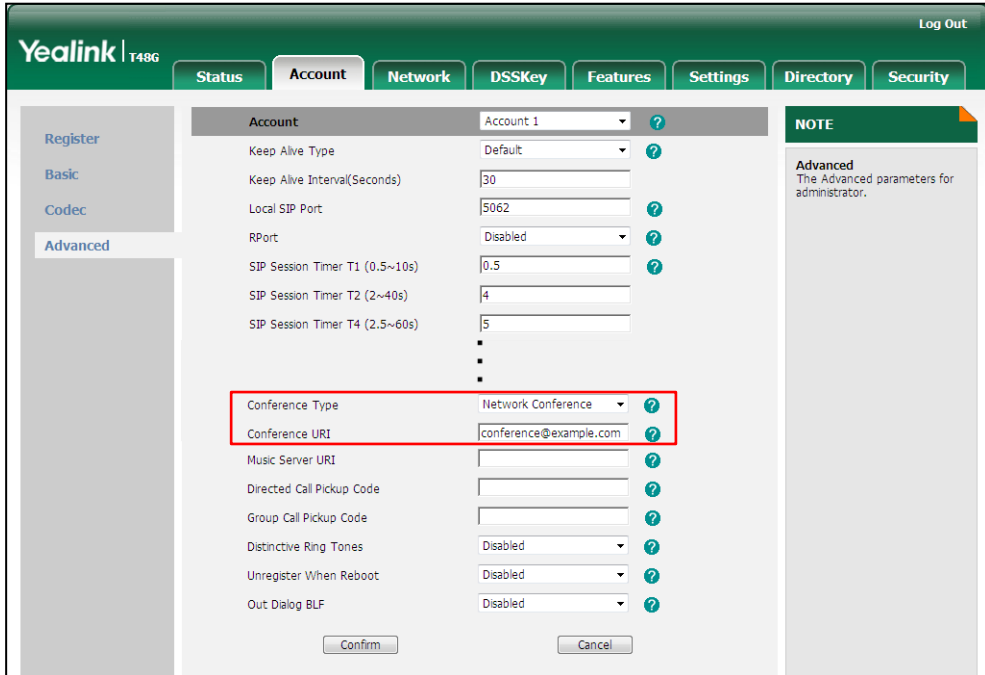

3. Enter the conference URI (e.g., conference@example.com) in the **Conference URI** field.



4. Click **Confirm** to accept the change.

**Note** Network conference is configurable via web user interface only.

**To set up a network conference call:**

1. Place a call to the first party.
2. Tap the **Conference** soft key to place a new call.  
The active call is placed on hold.
3. Enter the number of the second party and press  ,  , or tap the **Send** soft key.
4. When the second party answers the call, tap the **Conference** soft key to add the second party to the conference.
5. Tap the **Conference** soft key to place a new call.  
The conference call is placed on hold.
6. Enter the number of the new party and then press  ,  , or tap the **Send** soft key.
7. When the new party answers the call, tap the **Conference** soft key to add the new party to the conference.
8. Repeat steps 5 to 7 until you have added all intended parties.

The procedures to set up a network conference call on specific servers may be different from introduced above. Contact your system administrator for more information.

## Call Park

You can use call park to place a call on hold, and then retrieve the call from another phone in the system (for example, a phone in another office or conference room). You can park an active call by tapping the call park key on the phone. If the call is parked successfully, the response is either a voice prompt confirming that the call was parked, or a visible prompt on the touch screen.

### Note

Call park is not available on all servers. Contact your system administrator for more information.

To configure a call park key via phone user interface:

1. Tap **DSS Key**.
2. Tap the desired line key.
3. Tap the gray box of the **Type** field.
4. Tap **Key Event** from the pull-down list.
5. Tap the gray box of the **Key Type** field.
6. Tap **Call Park** from the pull-down list.
7. Tap the gray box of the **Account ID** field.
8. Tap the desired line from the pull-down list.
9. (Optional.) Enter the string that will appear on the touch screen in the **Label** field.
10. Enter the call park code in the **Value** field.



11. Tap the **Save** soft key to accept the change or  to cancel.
12. Tap **DSS Key** to return to the idle screen.

Call park key is configurable via web user interface at the path **DSSKey->Line Key**.

To use call park:

1. User on phone A places a call to phone B.
2. User on phone A wants to take the call in a conference room for privacy, and so taps the call park key on phone A.
3. User on phone A walks to an available conference room where the phone is designated as phone C. The user dials the call park retrieve code to retrieve the parked call.

The system establishes the call between phone C and B.

**Note**

The call park code and call park retrieve code are predefined on the system server. Contact your system administrator for more information.

If the parked call is not retrieved within a period of time assigned by the system, the phone performing call park will receive a call back.

## Call Pickup

You can use call pickup to answer someone else's incoming call on your phone. The SIP-T48G IP phone supports directed call pickup and group call pickup. Directed call pickup is used for picking up a call that is ringing at a target phone number. Group call pickup is used for picking up a call that is ringing at any phone number in a certain group. The pickup group should be predefined, contact your system administrator for more information.

You can pick up an incoming call by using the **DPickup/Gpickup** soft key. To use call pickup, you need to configure the call pickup code beforehand on a global or per-line basis via web user interface. The call pickup code configured on a per-line basis takes precedence over that configured on a global basis.

**Note**

If there are many incoming calls at the same time, tapping the **Gpickup** soft key on the phone will pick up the call that rings first.

### Directed Call Pickup

**To enable directed call pickup and configure the directed call pickup code on a global basis via web user interface:**

1. Click on **Features->Call Pickup**.
2. Select **Enabled** from the pull-down list of **Directed Call Pickup**.

- Enter the directed call pickup code in the **Directed Call Pickup Code** field.

- Click **Confirm** to accept the change.

To configure the directed call pickup code on a per-line basis via web user interface:

- Click on **Account**.
- Select the desired account from the pull-down list of **Account**.
- Click on **Advanced**.
- Enter the directed call pickup code in the **Directed Call Pickup Code** field.

- Click **Confirm** to accept the change.

To pick up a call directly:

- Pick up the handset or tap the line key.

The **DPickup** soft key appears above the on-screen keypad.



2. Tap the **DPickup** soft key on your phone when the target phone receives an incoming call.
3. Enter the phone number which is receiving an incoming call.
4. Tap the **DPickup** soft key again.

The call is answered on your phone.

You can also configure a line key as a directed pickup key via phone user interface or web user interface. Once configured, you can pick up a call by tapping the directed pickup key directly. For more information, refer to [Line Keys](#) on page 74.

## Group Call Pickup

To enable group call pickup and configure the group call pickup code on a global basis via web user interface:

1. Click on **Features->Call Pickup**.
2. Select **Enabled** from the pull-down list of **Group Call Pickup**.
3. Enter the group call pickup code in the **Group Call Pickup Code** field.

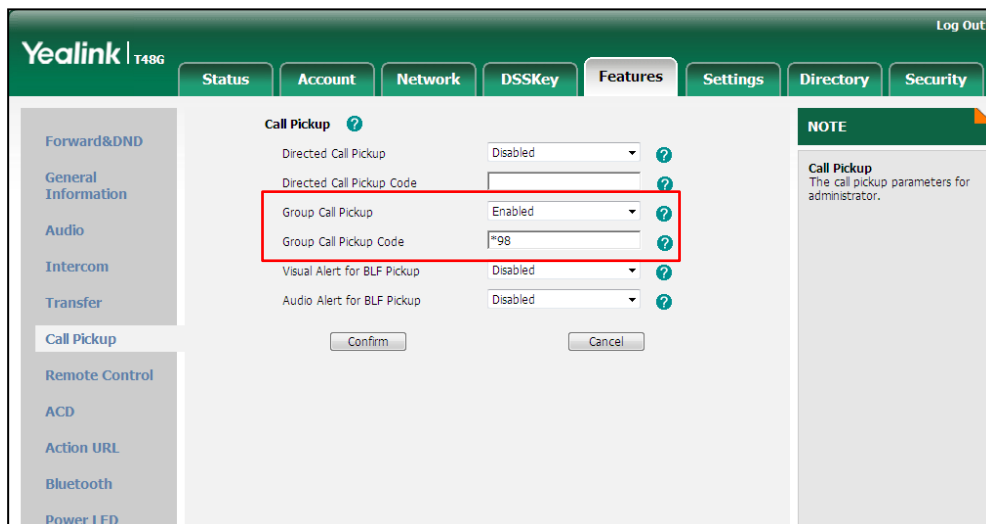

4. Click **Confirm** to accept the change.

To configure the group call pickup code on a per-line basis via web user interface:

1. Click on **Account**.
2. Select the desired account from the pull-down list of **Account**.
3. Click on **Advanced**.
4. Enter the group call pickup code in the **Group Call Pickup Code** field.

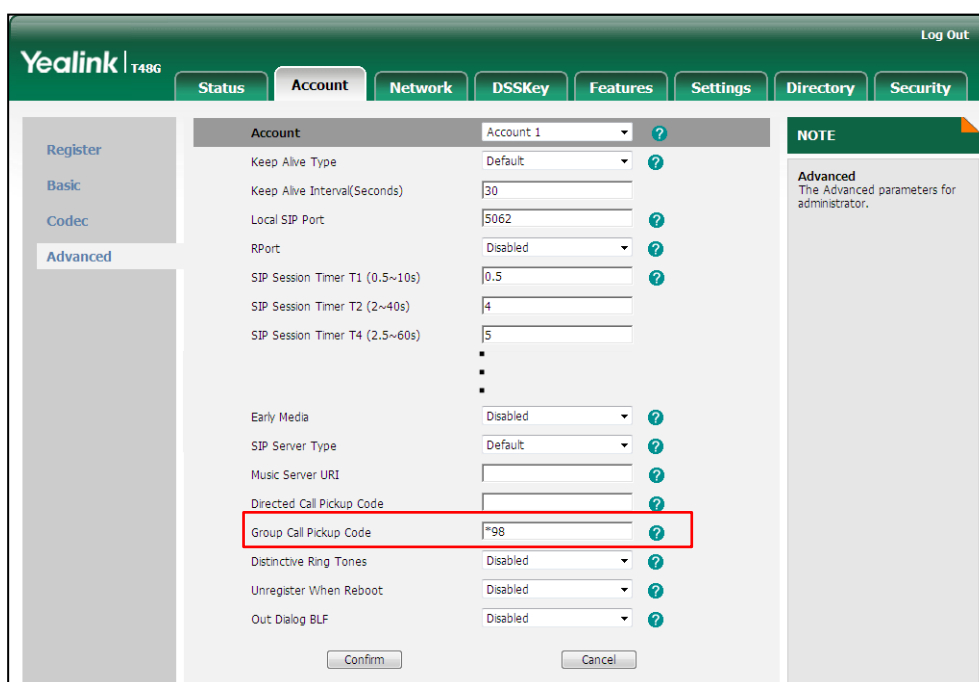

5. Click **Confirm** to accept the change.

To pick up a call in the group:

1. Pick up the handset or tap the line key.  
The **Gpickup** soft key appears on the on-screen keypad.



2. Tap the **Gpickup** soft key on your phone when a phone in the group receives an

incoming call.

The call is answered on your phone.

You can also configure a line key as a group pickup key via phone user interface or web user interface. Once configured, you can pick up a call by tapping the group pickup key directly.

**Note**

The directed call pickup code and group call pickup code are predefined on the system server. Contact your system administrator for more information.

## Anonymous Call

You can use anonymous call to block your identity and phone number from appearing to the called party when you call someone. For example, you want to call to consult some of the services, but don't want to be harassed. Anonymous call is configurable on a per-line basis. You can also configure the phone to send anonymous call on/off code to the server to activate/deactivate anonymous call on the server side.

**Note**

Anonymous call is not available on all servers. Contact your system administrator for the anonymous call on code and off code.

**To configure anonymous call via phone user interface:**

1. Tap  -> **Features**->**Anonymous**.
2. Tap the desired line.
3. Tap the **On** radio box of the **Local Anonymous** field.
4. (Optional.) Tap the **On Code** or **Off Code** radio box of the **Send Anonymous Code** field.
5. (Optional.) Enter the anonymous call on code and off code respectively in the **On Code** and **Off Code** field.



The phone will send the configured on code or off code depending on your selection when you enable or disable anonymous call feature on the phone.

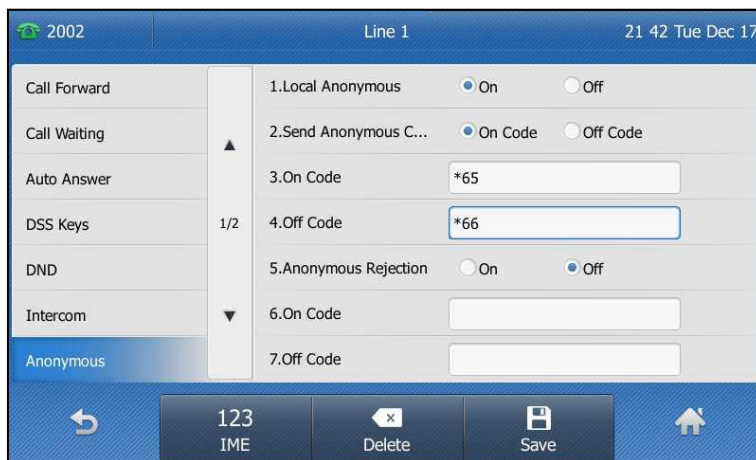

6. Tap the **Save** soft key to accept the change or  to cancel.

Anonymous call is configurable via web user interface at the path **Account->Basic**.

**To place an anonymous call:**

1. Using the specific line on the phone to place a call to phone B.

The touch screen of phone B prompts an incoming call from anonymity.



## Anonymous Call Rejection

You can use anonymous call rejection to reject incoming calls from anonymous callers. Anonymous call rejection automatically rejects incoming calls from callers who deliberately block their identities and numbers from being displayed. Anonymous call rejection is configurable on a per-line basis. You can also configure the phone to send anonymous call rejection on/off code to the server to activate/deactivate anonymous call rejection on the server side.

To configure anonymous call rejection via phone user interface:

1. Tap  -> **Features**->**Anonymous**.
2. Tap the desired line.
3. Tap the **On** radio box of the **Local Anonymous Rejection** field.
4. (Optional.) Tap the **On Code** or **Off Code** radio box of the **Send Anonymous Rejection Code** field.
5. (Optional.) Enter the anonymous call rejection on code and off code respectively in the **On Code** and **Off Code** field.

The phone will send the configured on code or off code depending on your selection when you enable or disable local anonymous rejection feature on the phone.

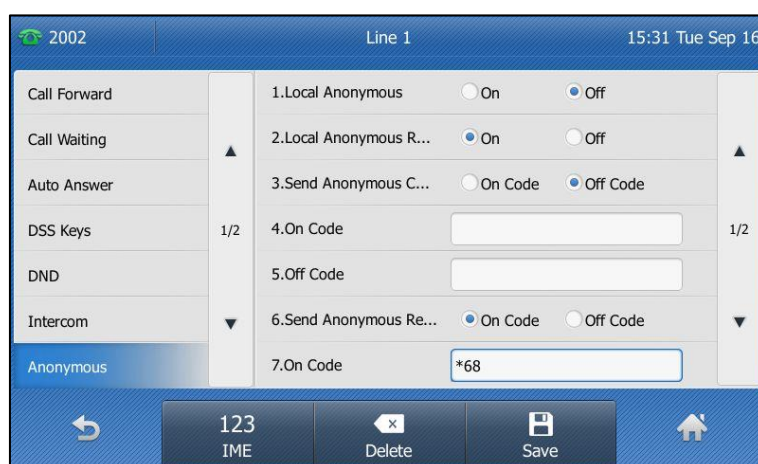

6. Tap the **Save** soft key to accept the change or  to cancel.

Anonymous call rejection is configurable via web user interface at the path **Account->Basic**.

If phone B has anonymous call feature enabled and places a call to your phone, the call will be rejected, and the touch screen of the phone B will display the following:



---

# Advanced Phone Features

---

This chapter provides operating instructions for the advanced features of the SIP-T48G IP phone. Topics include:

- [Busy Lamp Field \(BLF\)](#)
- [BLF List](#)
- [Call Recording](#)
- [Hot Desking](#)
- [Intercom](#)
- [Multicast Paging](#)
- [Music on Hold](#)
- [Automatic Call Distribution \(ACD\)](#)
- [Messages](#)

If you require additional information or assistance with your new phone, contact your system administrator.

## Busy Lamp Field (BLF)

You can use BLF to monitor a specific line for status changes on the phone. For example, you can configure a BLF key on the phone to monitor the status of a friend's line (busy or idle). The BLF key illuminates solid red when the friend's line is in use.

You can tap a BLF key to dial out the monitored phone number when the monitored line is idle. You can receive a visual or/and an audio alert (if enabled), and also pick up calls that are received on the monitored line. For more information, contact your system administrator.

### To configure a BLF key via phone user interface:

1. Tap **DSS Key**.
2. Tap the desired line key.
3. Tap the gray box of the **Type** field.
4. Tap **BLF** from the pull-down list.
5. Tap the gray box of the **Account ID** field.
6. Tap the desired line from the pull-down list.
7. (Optional.) Enter the string that will appear on the touch screen in the **Label** field.
8. Enter the phone number or extension you want to monitor in the **Value** field.

- (Optional.) Enter the pickup code in the **Extension** field.

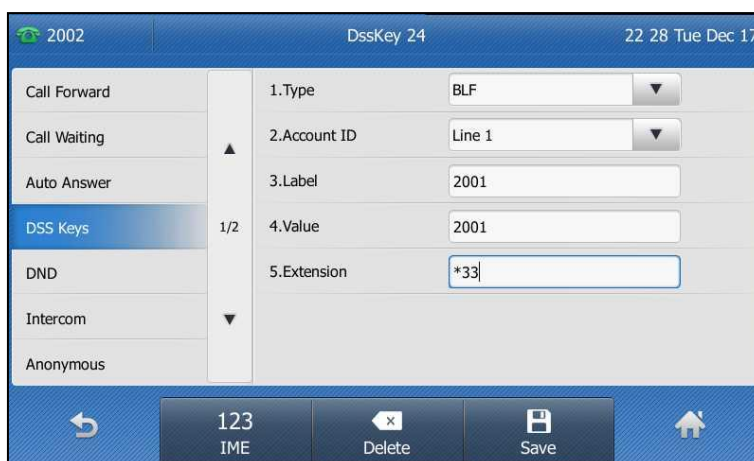

- Tap the **Save** soft key to accept the change or to cancel.

- Tap **DSS Key** to return to the idle screen.

BLF key is configurable via web user interface at the path **DSSKey->Line key**.

The following table lists the BLF key icon status:

Status of the BLF Key Icon	Status of the Monitored User
	The monitored user is idle.
(flashing)	The monitored user is placing a call to another user.
(flashing)	The monitored user receives an incoming intercom call.
	The monitored user is on an active call.
	The call of the monitored user is parked.
	The monitored user does not exist.

You can enable audio alert feature for BLF pickup on the phone. This allows the monitoring phone to play a warning tone when the monitored line receives an incoming call. You can also enable visual alert feature for BLF pickup on the phone. This allows the touch screen of the monitoring phone to display the caller ID when the monitored line receives an incoming call.

**To enable visual and audio alert features via web user interface:**

- Click on **Features->Call Pickup**.
- Select **Enabled** from the pull-down list of **Visual Alert for BLF Pickup**.

- Select **Enabled** from the pull-down list of **Audio Alert for BLF Pickup**.

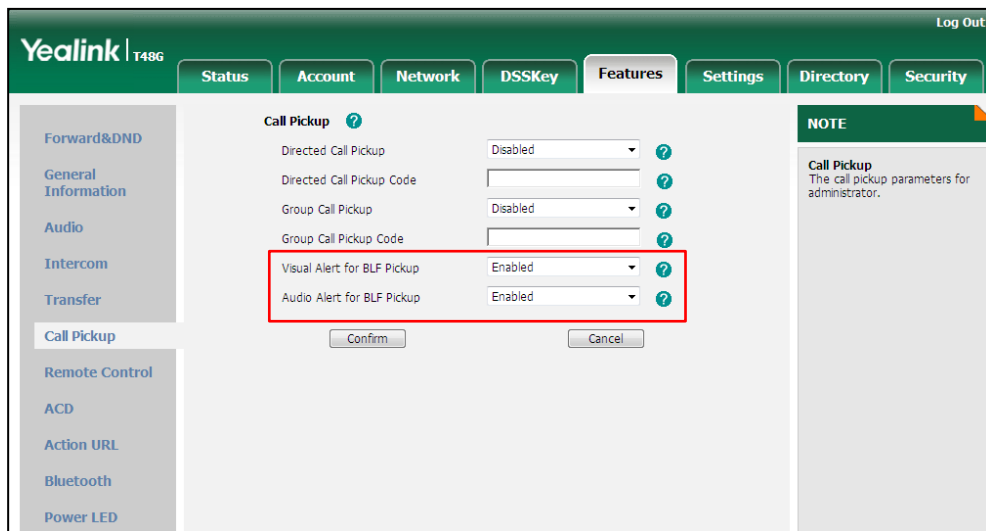

- Click **Confirm** to accept the change.

#### Note

Visual and audio alert features are configurable via web user interface only.

When the monitored line receives an incoming call, the following occurs on your phone:

- The phone plays a warning tone (if enabled).
- The BLF key icon illuminates red and flashes.
- The caller ID appears on the touch screen (if enabled).

In the following figure, the touch screen shows an incoming call from 2003 on the monitored line.



When there is an active call on the IP phone, you can transfer the active call or place a new call to the monitored phone number directly by tapping the BLF key. The phone handles the active call differently depending on the transfer mode via DSS key.

To configure the transfer mode via DSS key via web user interface:

1. Click on **Features->Transfer**.
2. Select the desired transfer mode from the pull-down list of **Transfer Mode Via Dsskey**. Depending on your selection:
  - If you select **Blind Transfer**, tap the BLF key to blind transfer the call to the monitored phone number.
  - If you select **Attended Transfer**, tap the BLF key to dial out the monitored phone number. Then you can perform the attended or semi-attended transfer.
  - If you select **New Call**, tap the BLF key to place a new call to the monitored user. The original call is placed on hold.

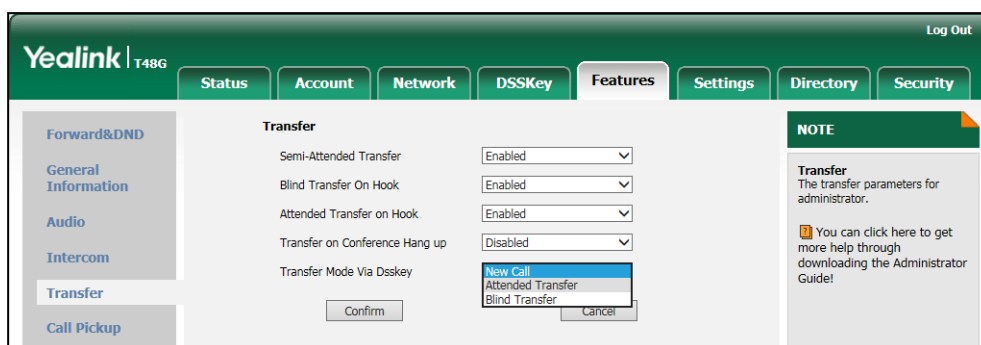

3. Click **Confirm** to accept the change.

#### Note

Transfer mode via DSS key is configurable via web user interface only.

## BLF List

You can use the BLF List feature to monitor a list of users defined by your system administrator. For example, your system administrator enables BLF List, and creates a BLF List URI (e.g., BLFList@example.com) including a list of user1, user2 on the server. The BLF List keys on the IP phone can present the status of user1 and user2. The key LEDs illuminate either flashing or solid depending on the status of those users. For more BLF List key LED indications, refer to LED Instructions on page 4.

You can use the BLF List keys in the following ways:

- When the monitored user is idle, tap the BLF list key to dial out the phone number.
- When there is already an active call on the IP phone, you can transfer the active call to the monitored user by tapping the BLF List key. The phone handles the active call differently depending on the transfer mode on DSS key. For more information on the transfer mode on DSS key, refer to [Transfer](#) on page 79.
- When the monitored user receives an incoming call, tap the BLF list key to pick up the call directly. Before picking up an incoming call, ensure that the directed

pickup code has been configured in advance. If the directed pickup code is not configured, the phone will place a call to the monitored user instead of picking up the incoming call of the monitored user when you press the BLF List key.

- When there is a conversation on the monitored user, tap the BLF list key to barge in and set up a conference call. Before barging in an active call, ensure that the barge-in code has been configured in advance. If the BLF list barge in code is not configured, the phone will place a call to the monitored user instead of barging in an active call of the monitored user when you press the BLF List key.
- When a call is being parked against the monitored phone, press the BLF List key to retrieve the parked call from the monitored user. Before retrieving the parked call, ensure that the BLF List Retrieve call parked Code has been configured in advance. If the code is not configured, the phone will place a call to the monitored user instead of retrieving the parked call when you press the BLF List key.

**To configure BLF List settings via web user interface:**

1. Click on **Account->Advanced**.
2. Select the desired account from the pull-down list of **Account**.
3. Enter the BLF List URI in the **BLF List URI** field.
4. (Optional.) Enter the directed pickup code in the **BLF List code** field.
5. (Optional.) Enter the barge-in code in the **BLF List Barge In Code** field.
6. (Optional.) Enter the call park retrieve code in the **BLF List Retrieve call parked Code** field.

The screenshot shows the Yealink T48G web user interface. The 'Account' tab is selected, and the 'Advanced' sub-tab is active. The 'BLF List' settings are highlighted with a red box. The settings are as follows:

Field	Value
Account	Account 1
Keep Alive Type	Default
Keep Alive Interval(Seconds)	30
BLF List URI	4609@pbx.yealink.com
BLF List Code	*97
BLF List Barge In Code	*33
BLF List Retrieve call parked Code	*88
Shared Line	Disabled
Dialog Info Call Pickup	Disabled
BLA Number	
Group Call Pickup Code	
Distinctive Ring Tones	Enabled
Unregister When Reboot	Disabled
Out Dialog BLF	Disabled
VQ RTPC-XR Collector name	
VQ RTPC-XR Collector address	
VQ RTPC-XR Collector port	5060
Accept SIP Trust Server Only	Disabled

Buttons for 'Confirm' and 'Cancel' are visible at the bottom of the form. A 'NOTE' box on the right side of the page provides additional information about the advanced parameters.

7. Click **Confirm** to accept the change.

**Note**

For more information on BLF List URI/BLF List Code/BLF List Barge In Code/BLF List Retrieve Call Parked Code, contact your system administrator.

According to the response message from the server, the IP phone will automatically configure the BLF List keys beginning from the first unused DSS key (The default order of BLF list keys assigned automatically is Line Key->Ext Key). Once any DSS key is seized, the IP phone will skip to configure the next DSS key.

You can receive a visual or/and an audio alert (if enabled) on your phone when the monitored user receives an incoming call. For more information, refer to Busy Lamp Field (BLF) on page [137](#).

**Note**

The pickup code is used in the following order of preference: BLF List Code (Account->Advanced)>Directed Call Pickup Code (Account->Advanced)>Directed Call Pickup Code (Features->Call Pickup). If all of them are not configured, tapping the BLF List key will directly call the monitored user when he/she receives an incoming call. For more information about pickup Code, refer to [Call Pickup](#) on page [130](#).

## Call Recording

You can record calls by tapping a record key on the phone. The SIPT48G IP phone supports record and URL record.

Two ways of call recording:

- **Record:** The phone sends a SIP INFO message containing a specific header "Record: on/off" to trigger a recording.
- **URL Record:** The phone sends an HTTP URL request to trigger a recording. Contact your system administrator for the predefined URL.

**Note**

Call record is not available on all servers. Contact your system administrator for more information.

**To configure a record key via phone user interface:**

1. Tap **DSS Key**.
2. Tap the desired line key.
3. Tap the gray box of the **Type** field.
4. Tap **Key Event** from the pull-down list.
5. Tap the gray box of the **Key Type** field.
6. Tap **Record** from the pull-down list.



- (Optional.) Enter a label that will appear on the touch screen in the **Label** field.



- Tap the **Save** soft key to accept the change or  to cancel.
- Tap **DSS Key** to return to the idle screen.

To configure a URL record key via phone user interface:

- Tap **DSS Key**.
- Tap the desired line key.
- Tap the gray box of the **Type** field.
- Tap **URL Record** from the pull-down list.
- (Optional.) Enter a label that will appear on the touch screen in the **Label** field.
- Enter the URL (e.g., `http://10.1.2.224/phonerecording.cgi`) in the **URL Record** field.



- Tap the **Save** soft key to accept the change or  to cancel.
- Tap **DSS Key** to return to the idle screen.

Record and URL record keys are configurable via web user interface at the path **DSSKey->Line Key**.



The Record and URL Record keys control the recording function, and are available:

- During an active call
- When calls are on hold or muted
- During a blind or attended transfer
- During a conference call





The Record and URL Record keys are not available when:

- There are no connected calls on your phone
- You place a new call

To record a call:

1. Tap the Record key or URL Record key during a call.  
If the recording starts successfully, the recording icon will appear on the touch screen and the icon of the Record key or URL Record key changes to .
2. Tap the Record key or URL Record key again to stop recording.  
The recording icon disappears from the touch screen and the icon of the Record key or URL Record key changes to .

Recording status indications you need to know:

Circumstance	Icons on the touch screen
A recording is started	 appears on the touch screen
A recording cannot be started	 appears for 1 second
A recording cannot be started	 appears for 1 second, then goes back to the recording icon
The recording box is full	 appears for 1 second
The call cannot be recorded	 appears for 1 second

You can listen to the recordings stored on your server system. For example, you can dial an access code to listen to the recordings.

**Note**

The way in which you listen to the recordings may be different depending on the server. Contact your system administrator for more information.

## Hot Desking

Hot desking originates from the definition of being the temporary physical occupant of a work station or surface by a particular employee. A primary motivation for hot desking is cost reduction. This feature is regularly used in places where not all the employees are in the office at the same time, or not in the office for very long, which means that actual personal offices would be often vacant, consuming valuable space

and resources.

You can use hot desking on the SIP-T48G IP phone to log out of existing accounts and then log into a new account. As a result, many users can share the phone resource at different times. To use this feature, you need to configure a hot desking key in advance.

**Note**

Hot desking is not available on all servers. Contact your system administrator for more information.

**To configure a hot desking key via phone user interface:**

1. Tap **DSS Key**.
2. Tap the desired line key.
3. Tap the gray box of the **Type** field.
4. Tap **Key Event** from the pull-down list.
5. Tap the gray box of the **Key Type** field.
6. Tap **Hot Desking** from the pull-down list.
7. (Optional.) Enter a label that will appear on the touch screen in the **Label** field.



8. Tap the **Save** soft key to accept the change or  to cancel.
9. Tap **DSS Key** to return to the idle screen.

Hot desking key is configurable via web user interface at the path **DSSKey->Line Key**.

**To use hot desking:**

1. Tap the **Hot Desking** key when the phone is idle.

The touch screen prompts the following warning:

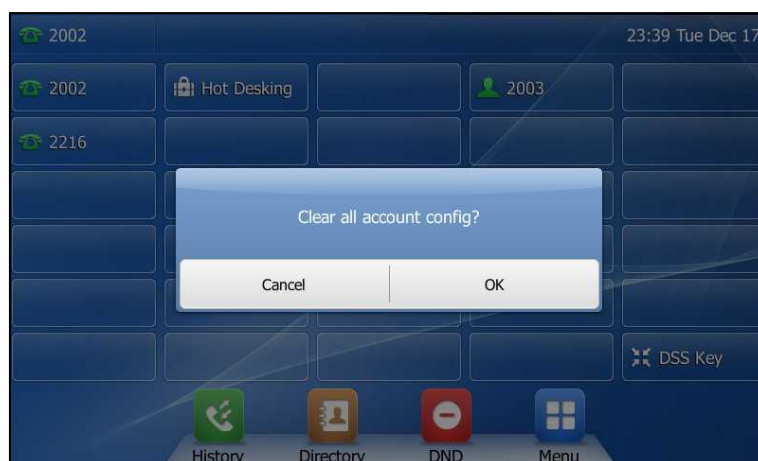

2. Tap the **OK** soft key.

Registration configurations of all accounts on the phone will be cleared immediately.

The login wizard will be displayed as below:



3. Enter the login information in each field.
4. Tap the **Save** soft key to login or  to cancel.

## Intercom

Intercom is a useful feature in an office environment to quickly connect with the operator or the secretary. You can tap the intercom key to automatically connect with a remote extension for outgoing intercom calls, and the remote extension will automatically answer incoming intercom calls.

**Note** Intercom is not available on all servers. Contact your system administrator for more information.

## Outgoing Intercom Calls

To configure an intercom key via phone user interface:

1. Tap **DSS Key**.
2. Tap the desired line key.
3. Tap the gray box of the **Type** field.
4. Tap **Intercom** from the pull-down list.
5. Tap the gray box of the **Account ID** field.
6. Tap the desired line from the pull-down list.
7. (Optional.) Enter the string that will appear on the touch screen in the **Label** field.
8. Enter the remote extension number in the **Value** field.

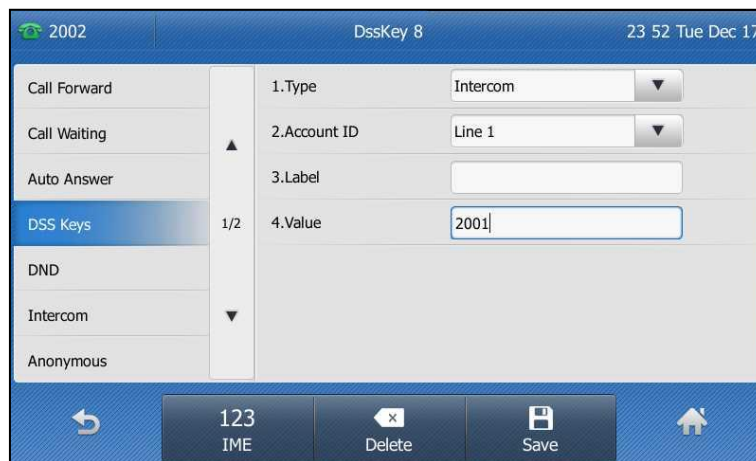

9. Tap the **Save** soft key to accept the change or  to cancel.
10. Tap **DSS Key** to return to the idle screen.

Intercom key is configurable via web user interface at the path **DSSKey->Line Key**.

To place an intercom call:

1. Tap the intercom key when the phone is idle.  
The phone is automatically connected to the extension specified in the **Value** field.
2. Tap the intercom key again or the **End Call** soft key to end the intercom call.

## Incoming Intercom Calls

The SIP-T48G IP phone supports to automatically answer an incoming intercom call by default. The phone automatically plays a warning tone when it receives an incoming intercom call. In addition, you can enable the phone to mute the microphone when it automatically answers an incoming intercom call. You can also enable the phone to

automatically answer an incoming intercom call while there is already an active call on the phone. The active call is then placed on hold.

Intercom features you need to know:

Intercom Feature	Description
Accept Intercom	Enable or disable the IP phone to automatically answer an incoming intercom call.
Intercom Mute	Enable or disable the IP phone’s microphone for intercom calls.
Intercom Tone	Enable or disable the IP phone to play a warning tone when it receives an incoming intercom call.
Intercom Barge	Enable or disable the IP phone to automatically answer an incoming intercom call while there is already an active call on the phone.

To configure intercom features via phone user interface:

1. Tap  -> **Features->Intercom**.
2. Make the desired changes.



3. Tap the **Save** soft key to accept the change or  to cancel.

These specific parameters are configurable via web user interface at the path **Features->Intercom**.

### Accept Intercom

You can enable or disable the phone to automatically answer an incoming intercom call. If Accept Intercom is enabled, the phone will automatically answer an incoming intercom call. If Accept Intercom is disabled, the phone will reject incoming intercom calls and send a busy message to the caller. Accept Intercom is enabled by default.

**Note**

Your administrator can set a period of delay time before the phone automatically answers intercom calls. Contact your system administrator for more information.

### Intercom Mute

You can mute or un-mute the phone's microphone for intercom calls automatically. If Intercom Mute is enabled, the microphone will be muted for intercom calls. If Intercom Mute is disabled, the microphone will work for intercom calls. Intercom Mute is disabled by default.

### Intercom Tone

You can enable or disable the phone to play a warning tone when receiving an intercom call. If Intercom Tone is enabled, the phone will play a warning tone before answering the intercom call. If Intercom Tone is disabled, the phone will automatically answer the intercom call without warning. Intercom Tone is enabled by default.

### Intercom Barge

You can enable or disable the phone to automatically answer an incoming intercom call while there is already an active call on the phone. If Intercom Barge is enabled, the phone will automatically answer the intercom call and place the active call on hold. If Intercom Barge is disabled, the phone will handle an incoming intercom call like a waiting call. Intercom Barge is disabled by default.

## Multicast Paging

You can use multicast paging to quickly and easily forward out time sensitive announcements out to people within the multicast group. You can configure a multicast paging key or a paging list key on the phone, which allows you to send a Real Time Transport Protocol (RTP) stream to the pre-configured multicast address(es) without involving SIP signaling. You can configure the phone to receive an RTP stream from pre-configured multicast listening address(es) without involving SIP signaling. You can specify up to 10 multicast listening addresses.

## Sending RTP Stream

To configure a multicast paging key via phone user interface:

1. Tap **DSS Key**.
2. Tap the desired line key.
3. Tap the gray box of the **Type** field.
4. Tap **Key Event** from the pull-down list.
5. Tap the gray box of the **Key Type** field.
6. Tap **Paging** from the pull-down list.
7. (Optional.) Enter the string that will appear on the touch screen in the **Label** field.

8. Enter the multicast IP address and port number (e.g., 224.5.6.20:10008) in the **Value** field.

The valid multicast IP addresses range from 224.0.0.0 to 239.255.255.255.



9. Tap the **Save** soft key to accept the change or  to cancel.
10. Tap **DSS Key** to return to the idle screen.

Multicast paging key is configurable via web user interface at the path **DSSKey->Line Key**.

**To configure a paging list key via phone user interface:**

1. Tap **DSS Key**.
2. Tap the desired line key.
3. Tap the gray box of the **Type** field.
4. Tap **Key Event** from the pull-down list.
5. Tap the gray box of the **Key Type** field.
6. Tap **Paging List** from the pull-down list.
7. (Optional.) Enter the string that will appear on the touch screen in the **Label** field.





8. Tap the **Save** soft key to accept the change or  to cancel.

Paging list key is configurable via web user interface at the path **DSSKey->Line Key**.

**To configure paging list via phone user interface:**

1. Tap the paging list key when the phone is idle.
2. Tap a desired paging group.

The default tag is Empty if it is not configured before.

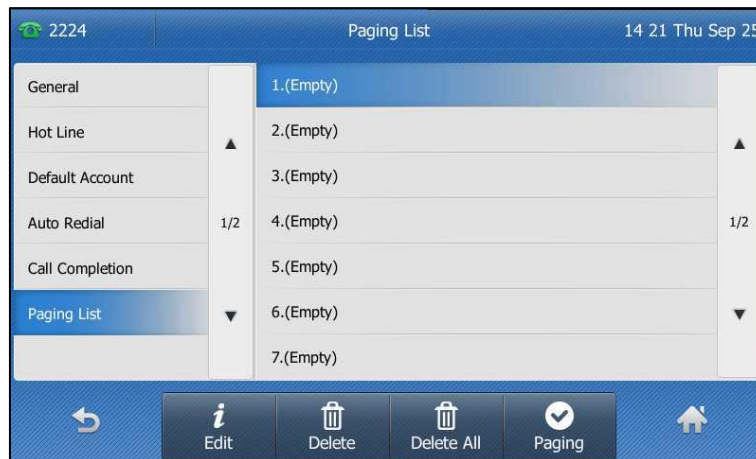

3. Tap the **Edit** soft key.

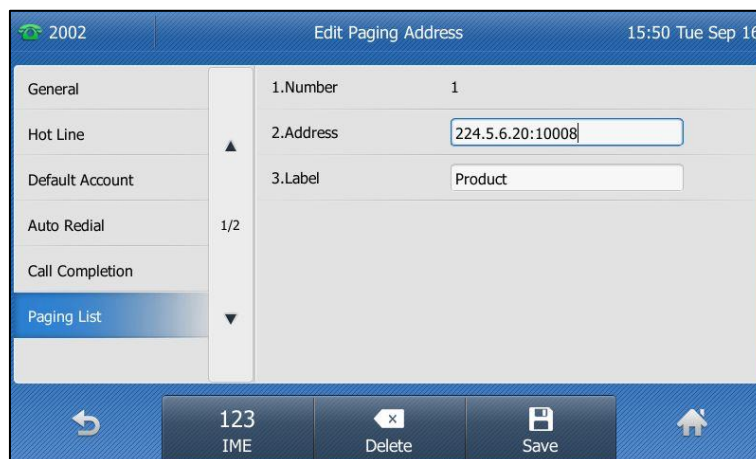

4. Enter the multicast IP address and port number (e.g., 224.5.6.20:10008) in the **Address** field.

The valid multicast IP addresses range from 224.0.0.0 to 239.255.255.255.

5. Enter the string that appear on the touch screen in the **Label** field
6. Tap the **Save** soft key to accept the change.
7. Repeat the step 2-6, you can add more paging groups.

Paging list is configurable via web user interface at the path **Directory->Multicast IP**.

**To delete paging group via phone user interface:**

1. Tap the Paging list key when the phone is idle.
2. Tap a desired group.
3. Tap the **Delete** soft key.

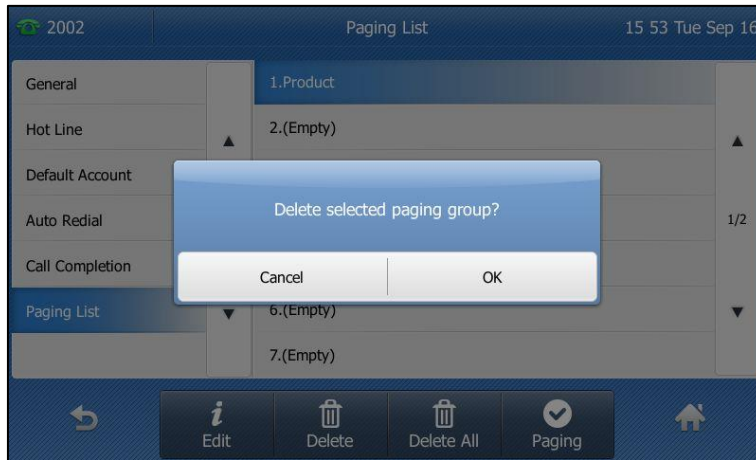

4. Tap the **OK** soft key to accept the change or the **Cancel** soft key to cancel.

If you want to delete all paging group, you can tap the **Delete All** soft key.

You can also configure the phone to use a default codec for sending multicast RTP stream via web user interface.

**To configure a default codec for multicast paging via web user interface:**

1. Click on **Features->General Information**.
2. Select the desired codec from the pull-down list of **Multicast Codec**.

The default codec is G722.

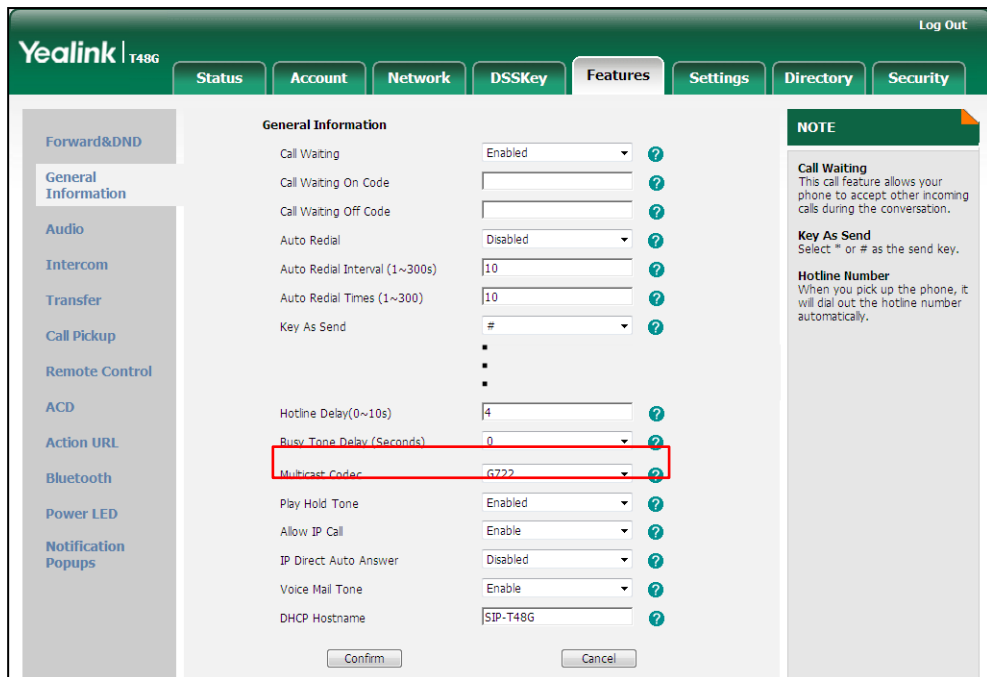

3. Click **Confirm** to accept the change.

**Note**

If G722 codec is used for multicast paging, the touch screen will display the icon  to indicate that it is providing high definition voice.

Default codec for multicast paging is configurable via web user interface only.

**To send RTP stream via a multicast paging key:**

1. Tap the multicast paging key when the phone is idle.

The phone sends RTP to a preconfigured multicast address (IP: Port). Any phone configured to listen to the multicast address may automatically answer the paging call and play receiving RTP. For more information on how to configure a phone to listen to a multicast, refer to [Receiving RTP Stream](#) on page 154. For both sending and receiving of the multicast RTP, there is no SIP signaling involved.

The multicast paging key illuminates solid green.

The following figure shows a multicast RTP session on the phone:



2. Tap the **Hold** soft key to place the current multicast RTP session on hold.
3. Tap the **End Call** soft key to cancel the multicast RTP session.

**Note**

Multicast RTP is one way only from the sender to the multicast address(es) (receiver). For outgoing RTP multicasts, all other existing calls on the phone will be placed on hold.

**To send RTP stream via a paging key list:**

1. Tap the paging list key when the phone is idle.

2. Tap the desired group.

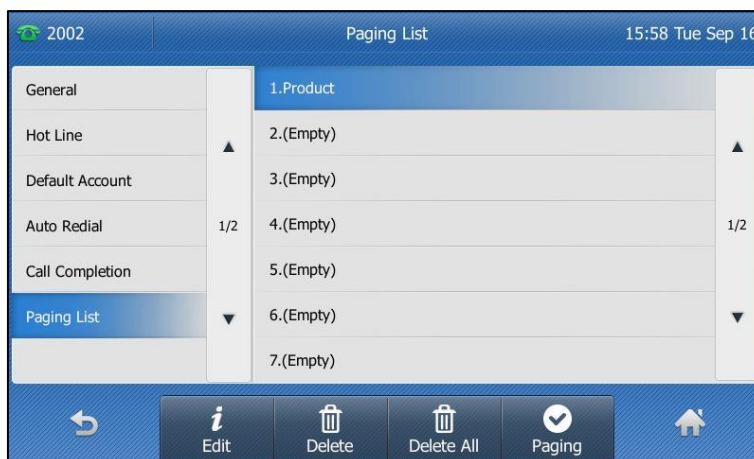

3. Tap the **Paging** soft key to send RTP.
4. Tap the **Hold** soft key to place the current multicast RTP session on hold.
5. Tap the **End Call** soft key to cancel the multicast RTP session.

## Receiving RTP Stream

You can configure the phone to receive a Real Time Transport Protocol (RTP) stream from the pre-configured multicast address(es) without involving SIP signaling. You can specify up to 10 multicast addresses that the phone listens to on the network.

How the phone handles incoming multicast paging calls depends on Paging Barge and Paging Priority Active parameters configured via web user interface.

### Paging Barge

The paging barge parameter defines the priority of the voice call in progress. If the priority of an incoming multicast paging call is lower than that of the active call, it will be ignored automatically. If Disabled is selected from the pull-down list of Paging Barge, the voice call in progress will take precedence over all incoming multicast paging calls. Valid values in the Paging Barge field:

- **1 to 10:** Define the priority of the active call, 1 with the highest priority, 10 with the lowest.
- **Disabled:** The voice call in progress will take precedence over all incoming paging calls.

### Paging Priority Active

The paging priority active parameter decides how the phone handles incoming multicast paging calls when there is already a multicast paging call on the phone. If enabled, the phone will ignore incoming multicast paging calls with lower priorities, otherwise, the phone will answer incoming multicast paging calls automatically and

place the previous multicast paging call on hold. If disabled, the phone will automatically ignore all incoming multicast paging calls.

**To configure multicast listening addresses via web user interface:**

1. Click on **Directory->Multicast IP**.
2. Select the desired value from the pull-down list of **Paging Barge**.
3. Select the desired value from the pull-down list of **Paging Priority Active**.
4. Enter the multicast IP address(es) and port number (e.g., 224.5.6.20:10008) which the phone listens to for incoming RTP multicast in the **Listening Address** field.
5. Enter the label in the **Label** field.

Label will appear on the touch screen when receiving the multicast RTP stream.

The screenshot shows the Yealink T48G web interface. The 'Directory' tab is selected, and the 'Multicast IP' sub-tab is active. The 'Paging Barge' dropdown is set to '10' and 'Paging Priority Active' is set to 'Enabled'. A table lists 10 multicast listening addresses. The first entry is '224.5.6.20:10008' with the label 'Paging 1' and priority '1'. A 'NOTE' box on the right states: 'Multicast IP: The multicast IP parameters for administrator.' At the bottom, there are 'Confirm' and 'Cancel' buttons.

IP Address	Listening Address	Label	Priority
1 IP Address	224.5.6.20:10008	Paging 1	1
2 IP Address			2
3 IP Address			3
4 IP Address			4
5 IP Address			5
6 IP Address			6
7 IP Address			7
8 IP Address			8
9 IP Address			9
10 IP Address			10

6. Click **Confirm** to accept the change.

### Note

The priorities of listening addresses are predefined: 1 with the highest priority, 10 with the lowest.

Both the multicast paging sender and the receiver's phones play a warning tone when establishing a multicast paging call.

Multicast listening addresses are configurable via web user interface only.

## Music on Hold

Music on hold (MoH) is the business practice of playing recorded music to fill the silence that would be heard by the party placed on hold. To use this feature, you should specify a SIP URI pointing to a Music on Hold Server account. When a call is placed on hold, the phone will send a SIP INVITE message to the Music on Hold Server account. The Music on Hold Server account automatically answers the SIP INVITE messages and immediately plays audio from some source located anywhere (LAN, Internet) to the

held party. Contact your system administrator for the SIP URI.

**To configure music on hold server via web user interface:**

1. Click on **Account**.
2. Select the desired account from the pull-down list of **Account**.
3. Click on **Advanced**.
4. Enter the SIP URI (e.g., sip:moh@sp.com) in the **Music Server URI** field.

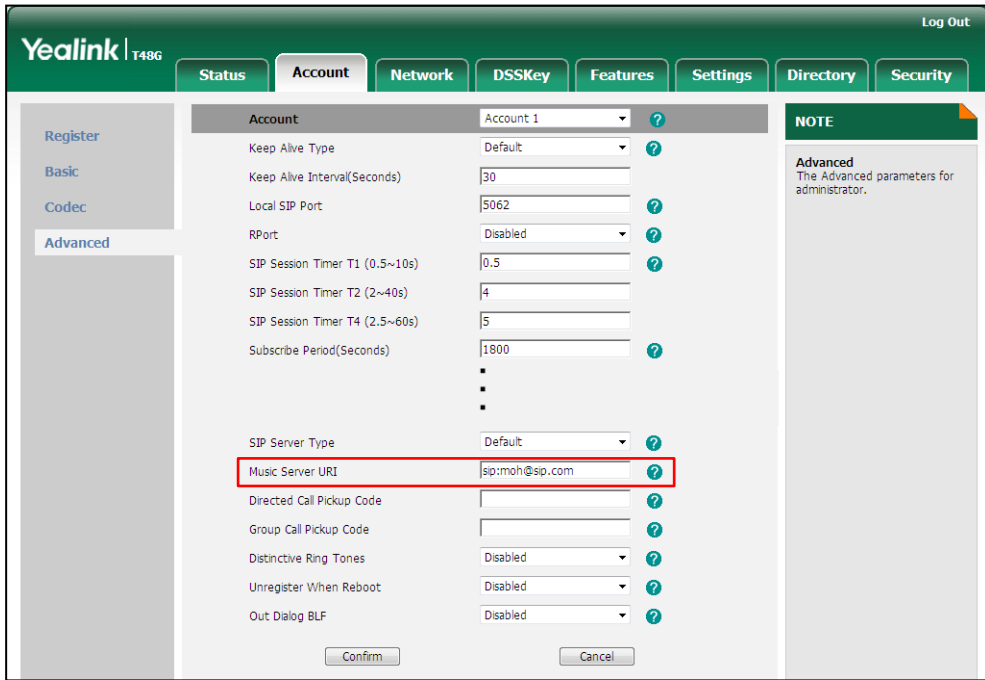

5. Click **Confirm** to accept the change.

When you place a call on hold, music will be played to the held party.

**Note**

For this feature to function, all involved parties cannot use encrypted RTP (SRTP).  
Music on hold server is configurable via web user interface only.

## Automatic Call Distribution (ACD)

ACD is often used in offices for customer service, such as call center. The ACD system handles large volumes of incoming calls from callers who have no need to talk to a specific person but who require assistance from any of multiple persons at the earliest opportunity. ACD on the SIP-T48G IP phone allows the ACD system to distribute large volumes of incoming calls to the registered ACD users. To use this feature, you should configure an ACD key in advance.

**Note**

Make sure ACD is enabled on your IP phone. For more information on enabling ACD, contact your system administrator.

**To configure an ACD key via phone user interface:**

1. Tap  -> **Features**->**DSS Keys**.
2. Tap the desired DSS key.
3. Tap the gray box of the **Type** field.
4. Tap **ACD** from the pull-down list.
5. (Optional.) Enter a label that will appear on the touch screen in the **Label** field.

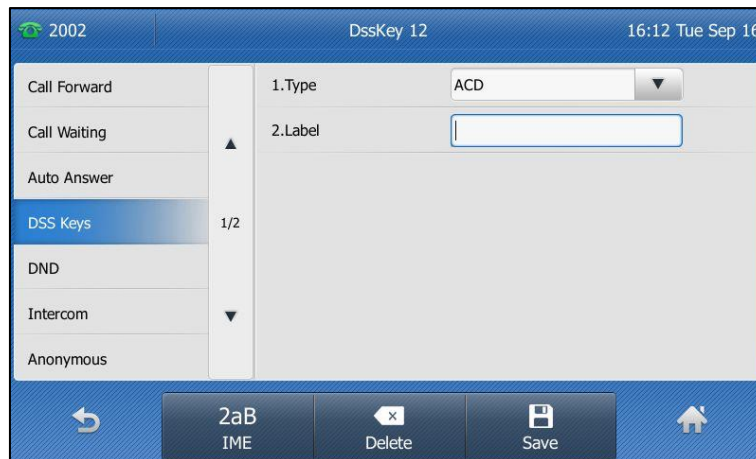

6. Tap the **Save** soft key to accept the change or  to cancel.

ACD key is configurable via web user interface at the path **DSSKey->Line Key**.

**To log into the ACD system:**

1. Tap the ACD key when the phone is idle.

The LCD screen prompts you the following information:

**User ID:** the identity used to log into the queue.

**Password:** the password used to log into the queue.

2. Tap the **Login** soft key to log in.

**Note**

Contact your system administrator for the User ID and Password to access the ACD system.

After configuring an ACD key, you can tap the ACD key to log into the ACD system. After logging in, you are ready to receive calls from the ACD system. You can tap the ACD key to show your current ACD user status. You can tap the **Available/Unavailable** soft key to change your ACD user status. ACD user status synchronizes on both IP phone and ACD system.

When you set the ACD user status to be available, the ACD key LED illuminates solid green, and then the server begins distributing calls to your phone.

When you set the ACD user status to be unavailable, the ACD key LED flashes green, and then the server temporarily stops distributing calls to your phone. To log out of the

ACD system, tap the **Logout** soft key.

**Note** It is recommended you configure no more than one ACD key per phone. At any time, at most one ACD key can be in progress on your phone.

## Messages

### Voice Mail

You can leave voice mails for someone else using the SIP-T48G IP phone. You can also listen to the voice mails that are stored in a voice mailbox. When receiving a new voice mail, the phone will play a warning tone, and the power indicator LED will slow flash red. The touch screen will prompt that the phone receives a new voice mail with the number of waiting voice mails (e.g., New Voice Mail(1)) and the  icon.

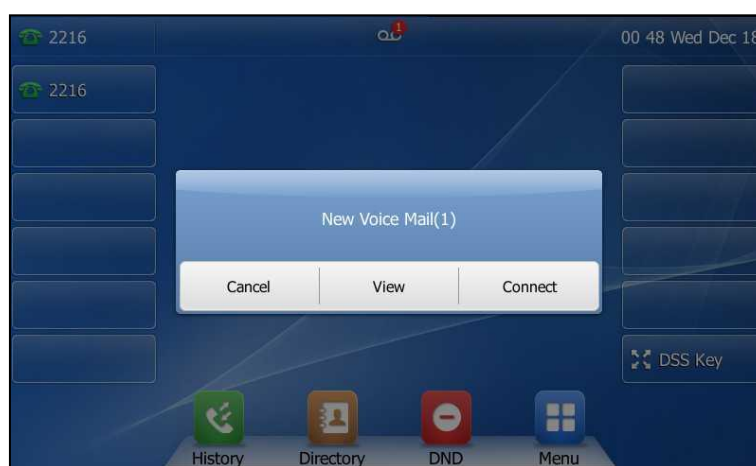

If the voice mail pop-up message box disappears, it won't pop up again unless the user receives a new voice mail or the user re-registers the account that has unread voice mail(s).

**Note** Voice Mail is not available on all servers. You can configure the phone not to display the pop-up prompt, contact your system administrator for more information.

The  icon on the status bar has a counter indicating the number of messages you haven't heard yet.

#### To leave a voice mail:

You can leave a voice mail for someone else when he/she is busy or inconvenient to answer the call. Follow the voice prompt from the system server to leave a voice mail, and then hang up.

#### To configure voice mail access codes via phone user interface:



1. Tap  -> **Messages**-> **Set Voice Mail**.
2. Enter the voice mail access code (e.g., \*88) in the desired account field.  
You can tap the **123** soft key to select the proper input mode.

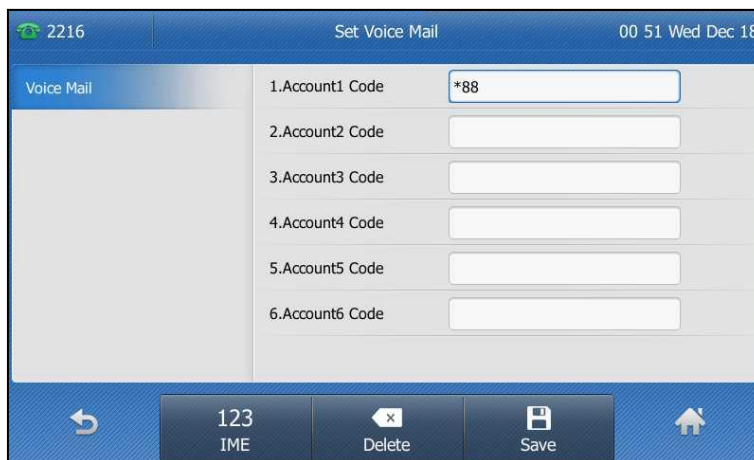



3. Tap the **Save** soft key to accept the change or  to cancel.

**Note**

Voice mail access codes must be predefined on the system server. Contact your system administrator for the more information.

**To listen to voice mails:**

1. When the touch screen prompts that the phone receives a new voice mail, press  or tap the **Connect** soft key to dial out the voice mail access code.
2. Follow the voice prompt to listen to your voice mails.

You can tap the  icon when the phone is idle to open the dialog box, and then tap the **Connect** soft key.

**Note**

Before listening to voice mails, ensure that the voice mail access code has been configured.

To view the voice mail via phone user interface:

1. Tap  -> Messages->View Voice Mail.

The touch screen displays the amount of new and old voice mails

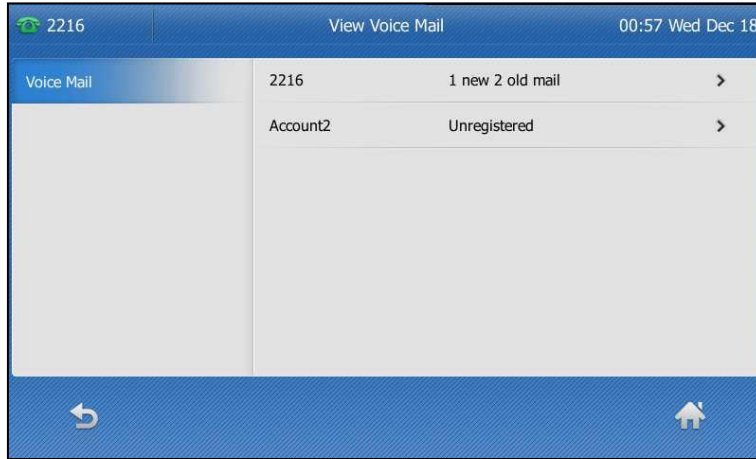

You can tap the account to listen to voice mails.

## Message Waiting Indicator (MWI)

The SIP-T48G IP phone supports MWI when receiving a new voice message. If someone leaves you a voice mail, you will receive a message waiting indicator. MWI will be indicated in three ways: a warning tone, an indicator message (including a voice mail icon) on the touch screen, and the power indicator LED slow flashes red. This will be cleared when you retrieve all voice mails or delete them.

The MWI service is unsolicited for some servers, so the SIP-T48G IP phone only handles the MWI messages sent from the server. But for other servers, the MWI service is solicited, so the SIP-T48G IP phone must enable subscription for MWI.

### Note

MWI service is not available on all servers. Contact your system administrator for more information.

The MWI subscription parameters you need to know:

Options	Description
<b>Subscribe for MWI</b>	Enable or disable a subscription for MWI service.
<b>MWI Subscription Period</b>	Period of MWI subscription. The IP phone sends a refresh SUBSCRIBE request before initial subscription expires.
<b>Subscribe MWI To Voice Mail</b>	Enable or disable a subscription to the voice mail number for MWI service.

Options	Description
	To use this feature, you should also configure the voice mail number.

**Note**

The phone will send SUBSCRIBE messages for MWI service to the account or the voice number MWI service depending on the server. Contact your system administrator for more information.

**To configure subscribe for MWI via web user interface**

1. Click on **Account**.
2. Select the desired account from the pull-down list of **Account**.
3. Click on **Advanced**.
4. Select **Enabled** from the pull-down list of **Subscribe for MWI**.
5. Enter the period time in the **MWI Subscription Period (Seconds)** field.

The screenshot shows the Yealink T48G web interface. The 'Account' tab is active, and the 'Advanced' sub-tab is selected. The 'Subscribe for MWI' setting is set to 'Enabled', and the 'MWI Subscription Period(Seconds)' is set to 3600. A red box highlights these two settings. Other settings visible include 'Keep Alive Type' (Default), 'Keep Alive Interval(Seconds)' (30), 'Local SIP Port' (5062), 'RPort' (Disabled), 'SIP Session Timer T1 (0.5~10s)' (0.5), 'SIP Session Timer T2 (2~40s)' (4), 'SIP Session Timer T4 (2.5~60s)' (5), 'Subscribe Period(Seconds)' (1800), 'DTMF Type' (RFC2833), 'DTMF Info Type' (DTMF-Relay), 'DTMF Payload Type(96~127)' (101), and 'Retransmission' (Disabled). A 'NOTE' box on the right states: 'Advanced: The Advanced parameters for administrator.'

6. Click **Confirm** to accept the change.

The IP phone will subscribe to the account number for MWI service by default.

**To enable Subscribe MWI to Voice Mail via web user interface:**

1. Click on **Account**.
2. Select the desired account from the pull-down list of **Account**.
3. Click on **Advanced**.
4. Select **Enabled** from the pull-down list of **Subscribe MWI To Voice Mail**.

- Enter the desired voice mail number in the **Voice Mail** field.

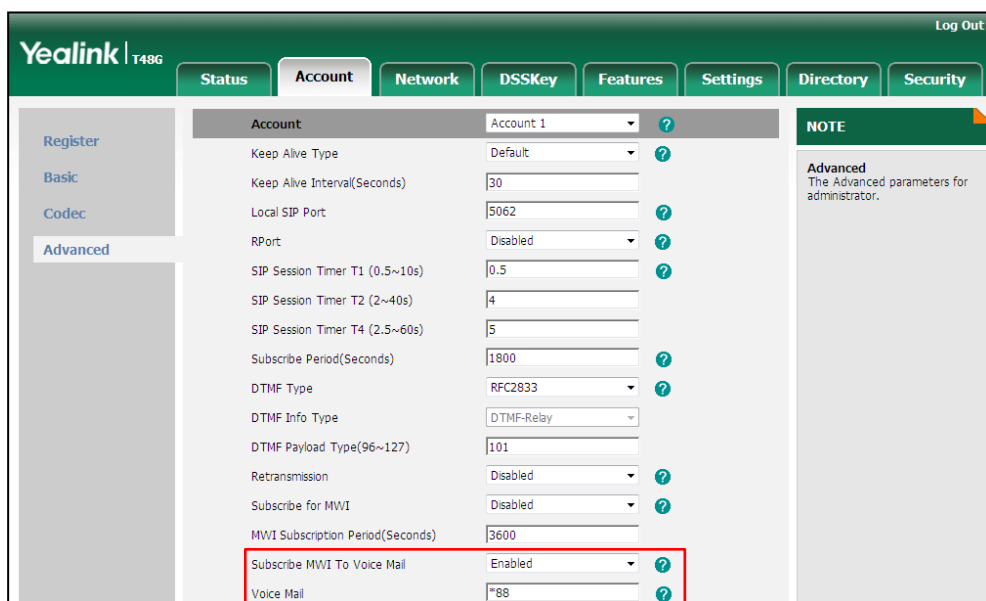

- Click **Confirm** to accept the change.

The IP phone will subscribe to the voice mail number for MWI service using **Subscribe MWI to Voice Mail**.

**Note** MWI subscription is configurable via web user interface only.

# Troubleshooting

---

This chapter provides general troubleshooting information to help you solve the problems you might encounter when using your SIP-T48G IP phone.

If you require additional information or assistance with your new phone, contact your system administrator.

## Why is the touch screen blank?

- Ensure that the phone is properly plugged into a functional AC outlet.
- Ensure that the output of the power adapter is 5V/2A.
- Ensure that the phone is plugged into a socket controlled by a switch that is on.
- If the phone is plugged into a power strip, try to plug it directly into a wall outlet instead.
- If the phone is powered from PoE, ensure that you use a PoE-compliant switch or hub.

## Why does the phone display "Network Unavailable.?"

- Ensure that the Ethernet cable is plugged into the Internet port on the phone and the Ethernet cable is not loose.
- Ensure that the switch or hub in your network is operational.

## Why doesn't the phone display time and date correctly?

Check if you have configured the phone to obtain the time and date from the SNTP server automatically. If the phone fails to connect to the SNTP server, contact your system administrator for more information. You can also configure the time and date manually. For more information, refer to [Time & Date](#) on page 29.

## How do I find the basic information of the IP phone?

Press the OK key when the IP phone is idle to check the basic information of the IP phone, such as IP address and firmware version. For more basic information, refer to [Phone Status](#) on page 19.

## How to obtain the MAC address of a phone when the phone is not powered on?

Three ways to obtain the MAC address of a phone:

- You can ask your supplier for the shipping information sheet which includes MAC addresses according to the corresponding PO (Purchase Order).
- You can find the MAC address on the label of carton box.

- You can also find the MAC address from the phone's bar code on the back of the phone.

#### **Why can't I get a dial tone?**

- Check for any loose connections and that the phone has been installed properly. For the installation instructions, refer to [Phone Installation](#) on page 12.
- Switch between the Handset, Headset (if present) or Hands-Free Speakerphone to check whether the dial tone is present for one of the audio modes.  
If the dial tone exists on another audio mode, connect a different handset or headset to isolate the problem.

#### **Why doesn't the phone ring?**

Check the ringer volume on the phone. To adjust the ringer volume setting, press the Volume key when the phone is on-hook and idle. For more information, refer to [Volume](#) on page 33.

#### **Why can't I receive calls?**

- Check the SIP registration with your system administrator.
- Check that the DND (Do Not Disturb) mode is deactivated on your phone. Refer to [Do Not Disturb \(DND\)](#) on page 110.
- Check that call forward is disabled on the phone. Refer to [Call Forward](#) on page 115.
- Check whether the caller number is stored in the blacklist directory. Refer to [Blacklist](#) on page 56.

#### **Why does my handset not work?**

Check that the handset cord is fully connected to both the handset jack on the phone and handset. Refer to [Phone Installation](#) on page 12.

#### **Why does my headset not work?**

- Check that the headset cord is properly connected to the headset jack on the phone. Refer to [Phone Installation](#) on page 12.
- Check that the headset mode is activated. Refer to [Headset Use](#) on page 65.
- Check that the headset volume is adjusted to an appropriate level. Refer to [Volume](#) on page 33.

#### **What is the difference between user name, register name and display name?**

Both user name and register name are defined by the server. A user name is used to identify the account while a register name matched with a password is used for

authentication if required by the server. Display name is the caller ID that will be displayed on the called party's touch screen. Server configuration may override the local configuration.

### Why does the phone play a tone when there is a call on hold? How to disable it?

When there is a call on hold, the phone will play a hold tone every 30 seconds. Call hold tone is enabled by default. Call hold tone and the interval of playing a hold tone are configurable via web user interface only.

To configure call hold tone and call hold tone delay via web user interface:

1. Click on **Features->General Information**.
2. Select the desired value from the pull-down list of **Play Hold Tone**.
3. Enter the desired time in the **Play Hold Tone Delay** field.

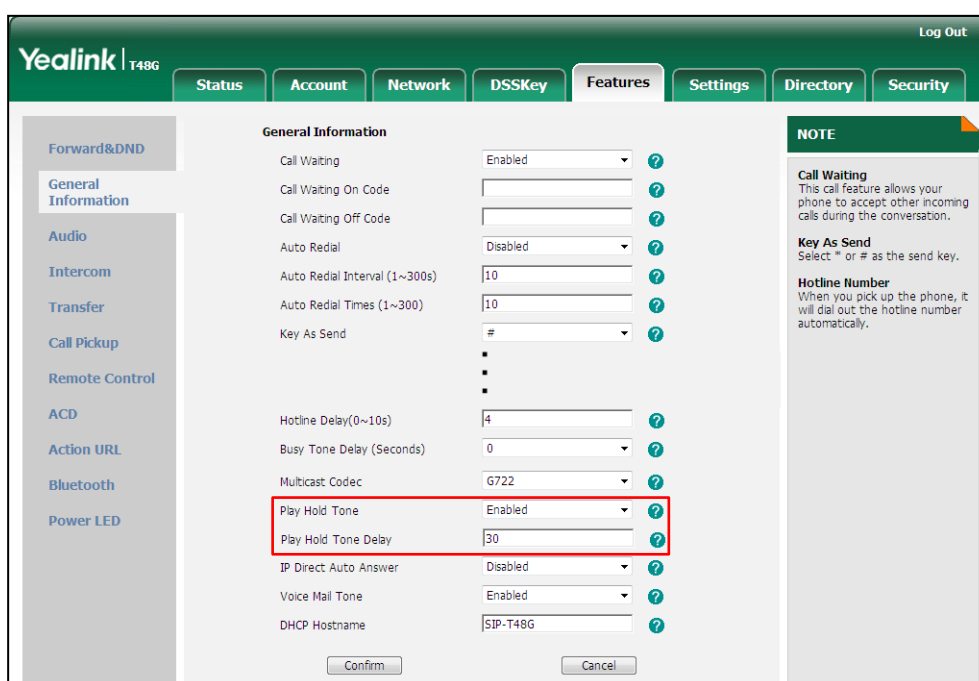

4. Click **Confirm** to accept the change.

### Why does the wallpaper has bad display?

Do one of the following:

- Check that the custom image is clear.
- Check that the file format of the custom image for the wallpaper is \*.jpg, \*.png or \*.bmp.
- Check that the custom image is neither too large nor too small. The phone will adjust the image to be able to display it.
- Check the picture resolution of the wallpaper. The wallpaper resolution of the SIP-T48G IP phone is 800\*480 pixels.

## How to change the user password?

To change the user password via web user interface:

1. Click on **Security->Password**.
2. Select **User** from the pull-down list of **User Type**.
3. Enter the new user password in the **New Password** field and **Confirm Password** field.

The screenshot shows the 'Security' tab in the Yealink T48G web interface. Under the 'Password' sub-tab, there is a form with the following fields: 'User Type' (a dropdown menu currently showing 'User'), 'Old Password' (a text input field), 'New Password' (a masked text input field), and 'Confirm Password' (another masked text input field). Each field has a help icon (a question mark in a circle). At the bottom of the form are 'Confirm' and 'Cancel' buttons. On the right side of the form, there is a 'NOTE' box with the following text: 'User Type: Select your type. If you log in as user, you can only change your own password. If you login as an administrator, you can modify both the user's and admin's passwords.'

4. Click **Confirm** to accept the change.

You can also contact your system administrator for help.

### Note

If you are logging into the web user interface of the phone with user credentials, you need to enter the current user password in the **Old Password** field.

User password is configurable via web user interface only.

## How to make a call using SRTP?

You can enable SRTP to encrypt the audio stream(s) of phone calls. The parties participating in the call should enable SRTP on a per-line basis.

To enable SRTP on a per-line basis via web user interface:

1. Click on **Account**.
2. Select the desired account from the pull-down list of **Account**.
3. Click on **Advanced**.



- Select the desired value (Optional or Compulsory) from the pull-down list of RTP Encryption (SRTP).

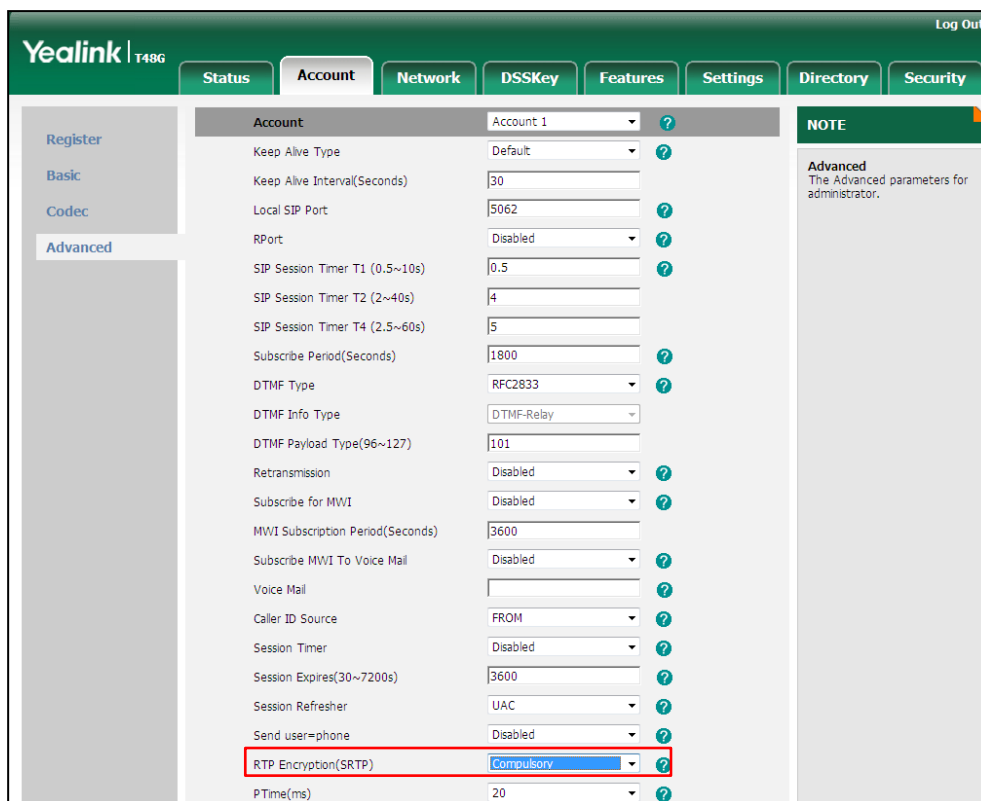

- Click **Confirm** to accept the change.

**Note**

SRTP is not available on all servers. Contact your system administrator for more information.

SRTP is configurable via web user interface only.

**How to reboot the phone?**

To reboot the phone via web user interface:

- Click on **Settings->Upgrade**.
- Click **Reboot** to reboot the IP phone.

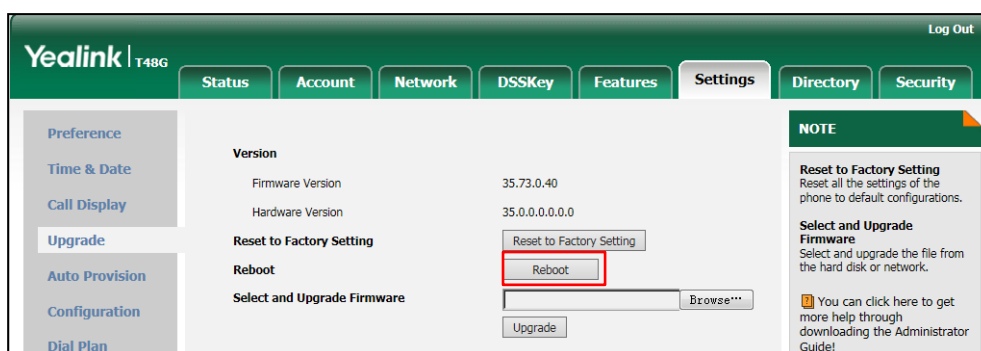

Any reboot of the phone may take a few minutes.

### How to export PCAP trace?

We may need you to provide a PCAP trace to help analyze your problem.

#### To export a PCAP trace via web user interface:

1. Click on **Settings->Configuration**.
2. Click **Start** to begin capturing signal traffic.
3. Recreate the error to be documented in the trace.
4. Click **Stop** to stop the capture.
5. Click **Export** to open the file download window, and then save the file to your local system.

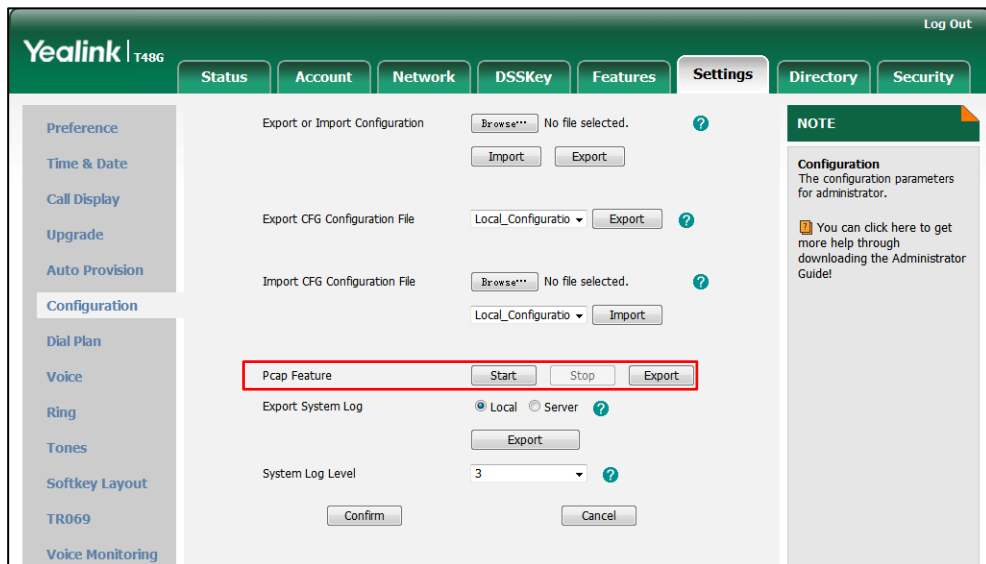

### How to export system log?

We may need you to provide a system log to help analyze your problem.

#### To export the system log to a local PC via web user interface:

1. Click on **Settings->Configuration**.
2. Select **6** from the pull-down list of **System Log Level**.
3. Click **Confirm** to accept the change.
4. Mark the **Local** radio box in the **Export System Log** field.
5. Reproduce the issue.

- Click **Export** to open the file download window, and then save the file to your local system.

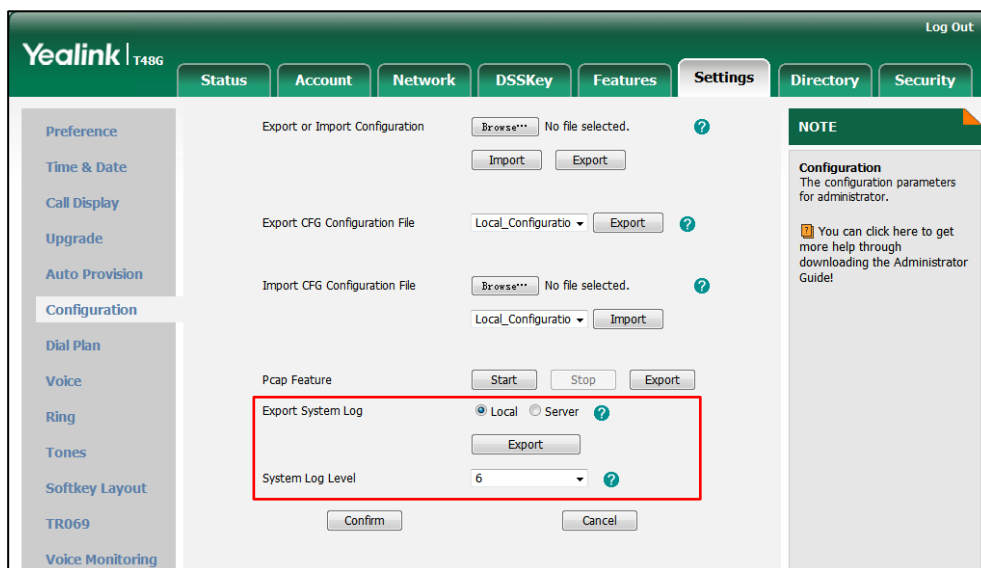

You can also export the system log to a syslog server. Contact your system administrator for more information.

**Note**

It is recommended to reset the syslog level to 3 after exporting the system syslog.

**How to export/import the phone configurations?**

We may need you to provide the phone configurations to help analyze your problem. In some instance, you may need to import configurations to your phone.

**To export the phone configurations via web user interface:**

- Click on **Settings->Configuration**.

- In the **Export or Import Configuration** block, click **Export** to open the file download window, and then save the file to your local system.

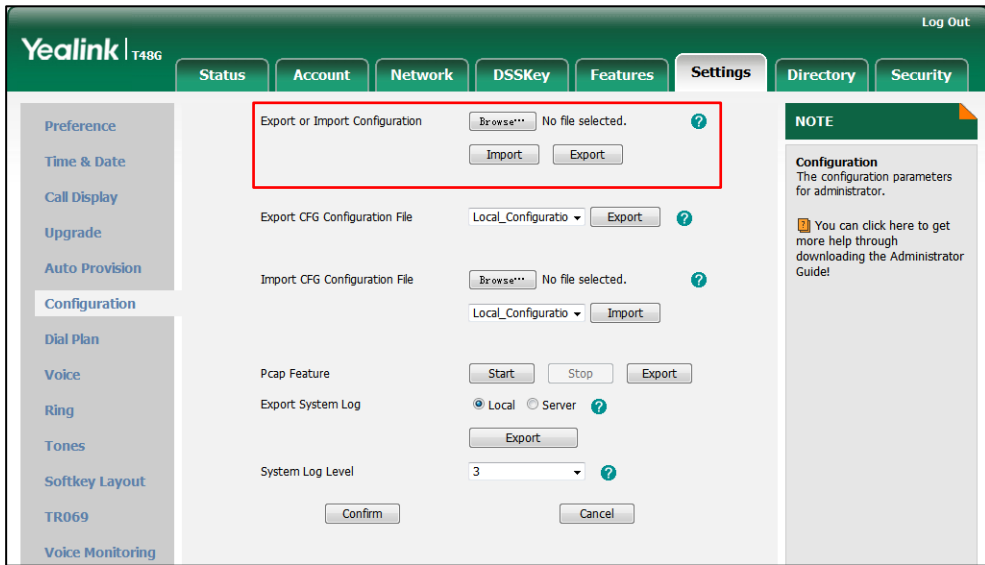

**To import the phone configurations via web user interface:**

- Click on **Settings->Configuration**.
- In the **Export or Import Configuration** block, click **Browse** to locate a configuration file from your local system.
- Click **Import** to import the configuration file.

**Note** The file format of the configuration file must be \*.bin.

**How to upgrade firmware?**

**To upgrade firmware via web user interface:**

- Click on **Settings->Upgrade**.
- Click **Browse** to locate the required firmware from your local system.

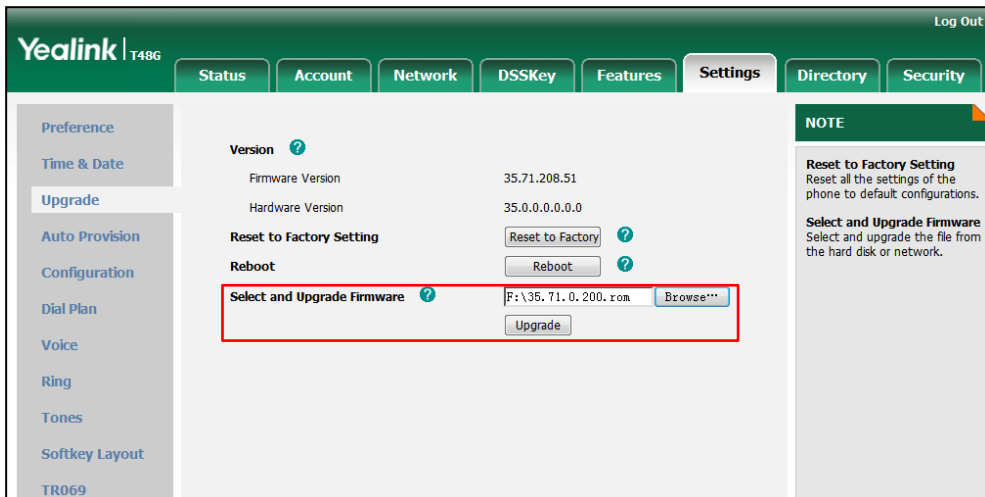

3. Click **Upgrade** to upgrade the firmware.

The browser pops up the dialog box "Firmware of the SIP Phone will be updated. It will take 5 minutes to complete. Please don't power off!".

4. Click **OK** to confirm upgrading.

### How to reset the phone?

Reset the phone to factory configurations after you have tried all troubleshooting suggestions but do not solve the problem.

Three ways to reset the phone:

- **Full Reset:** All configurations and userdata on the phone will be reset.
- **Config Reset:** All configurations (e.g., account, call history) set on the phone will be reset.
- **Userdata Reset:** All custom data (e.g., ring tone) set on the phone will be reset.

Contact your system administrator before resetting the phone.

### To reset the phone via phone user interface:

1. Tap  -> **Advanced** (default password: admin) -> **Reset to Factory**.
2. Tap the gray box of the **Reset Option** field.
3. Tap the desired reset option from the pull-down list.
4. Tap the **Reset** key.

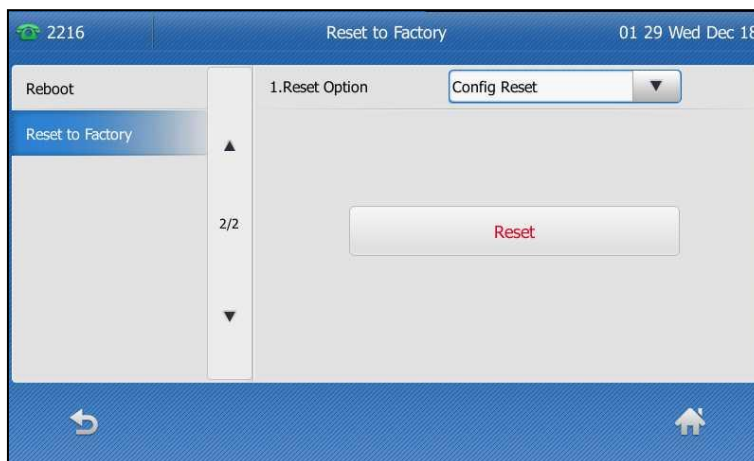

The touch screen prompts the following warning:

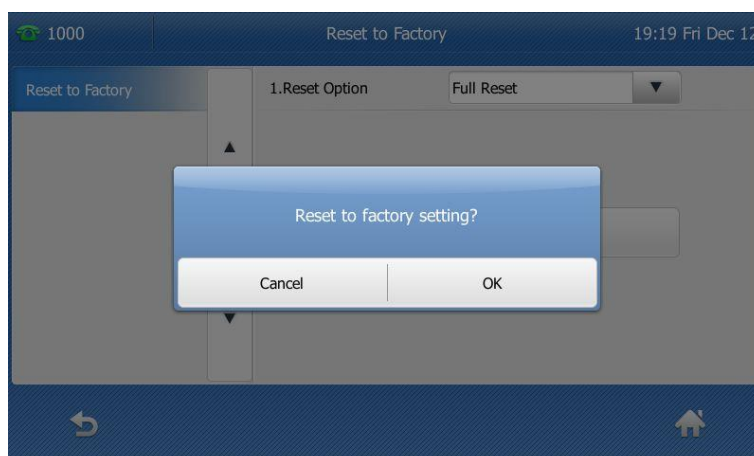

5. Tap the **OK** soft key.

The phone begins resetting.

After reset, the touch screen prompts "Welcom Initializing...Please wait".

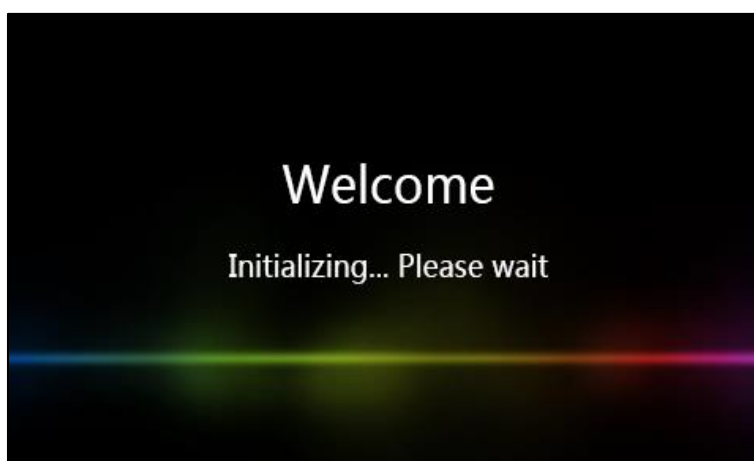

The phone will be reset to factory settings successfully after startup.

**Note**

Reset of your phone may take a few minutes. Do not power off until the phone has started up successfully.

# Regulatory Notices

## Service Agreements

Contact your Yealink Authorized Reseller for information about service agreements applicable to your product.

## Limitations of Liability

TO THE FULL EXTENT ALLOWED BY LAW, YEALINK EXCLUDES FOR ITSELF AND ITS SUPPLIERS ANY LIABILITY, WHETHER BASED IN CONTRACT OR TORT (INCLUDING NEGLIGENCE), FOR INCIDENTAL, CONSEQUENTIAL, INDIRECT, SPECIAL, OR PUNITIVE DAMAGES OF ANY KIND, OR FOR LOSS OF REVENUE OR PROFITS, LOSS OF BUSINESS, LOSS OF INFORMATION OR DATA, OR OTHER FINANCIAL LOSS ARISING OUT OF OR IN CONNECTION WITH THE SALE, INSTALLATION, MAINTENANCE, USE, PERFORMANCE, FAILURE, OR INTERRUPTION OF ITS PRODUCTS, EVEN IF YEALINK OR ITS AUTHORIZED RESELLER HAS BEEN ADVISED OF THE POSSIBILITY OF SUCH DAMAGES, AND LIMITS ITS LIABILITY TO REPAIR, REPLACEMENT, OR REFUND OF THE PURCHASE PRICE PAID, AT YEALINK'S OPTION. THIS DISCLAIMER OF LIABILITY FOR DAMAGES WILL NOT BE AFFECTED IF ANY REMEDY PROVIDED HEREIN SHALL FAIL OF ITS ESSENTIAL PURPOSE.

## Safety Instructions

**Save these instructions. Read these safety instructions before use!**

The following basic safety precautions should always be followed to reduce the risk of fire, electrical shock, and other personal injury.

### General Requirements

- Before you install and use the device, read the safety instructions carefully and observe the situation during operation.
- During the process of storage, transportation, and operation, please always keep the device dry and clean.
- During the process of storage, transportation, and operation, please avoid collision and crash of the device.
- Please do not attempt to dismantle the device by yourself. In case of any discrepancy, please contact the appointed maintenance center for repair.
- Without prior written consent, no organization or individual is permitted to make any change to the structure or the safety design of the device. Yealink is under no circumstances liable to consequences or legal issues caused by such changes.
- Please refer to the relevant laws and statutes while using the device. Legal rights of others should also be respected as well.

### Environmental Requirements

- Place the device at a well-ventilated place. Do not expose the device under direct sunlight.
- Keep the device dry and free of dust.

- Place the device on a stable and level platform.
- Please do not place heavy objects on the device in case of damage and deformation caused by the heavy load.
- Keep at least 10 cm between the device and the closest object for heat dissipation.
- Do not place the device on or near any inflammable or fire-vulnerable object, such as rubber-made materials.
- Keep the device away from any heat source or bare fire, such as a candle or an electric heater.
- Keep the device away from any household appliance with a strong magnetic field or electromagnetic field, such as a microwave oven or a refrigerator.

### **Operating Requirements**

- Do not let a child operate the device without guidance.
- Do not let a child play with the device or any accessory in case of accidental swallowing.
- Please only use the accessories provided or authorized by the manufacturer.
- The power supply of the device must meet the requirements of the input voltage of the device. Please use the provided surge protection power socket only.
- Before plugging or unplugging any cable, make sure that your hands are completely dry.
- Do not spill liquid of any kind on the product or use the equipment near water, for example, near a bathtub, washbowl, kitchen sink, wet basement or near a swimming pool.
- Do not tread on, pull, or over-bend any cable in case of malfunction of the device.
- During a thunderstorm, stop using the device and disconnect it from the power supply. Unplug the power plug and the Asymmetric Digital Subscriber Line (ADSL) twisted pair (the radio frequency cable) to avoid lightning strike.
- If the device is left unused for a rather long time, disconnect it from the power supply and unplug the power plug.
- When there is smoke emitted from the device, or some abnormal noise or smell, disconnect the device from the power supply, and unplug the power plug immediately. Contact the specified maintenance center for repair.
- Do not insert any object into equipment slots that is not part of the product or auxiliary product.
- Before connecting a cable, connect the grounding cable of the device first. Do not disconnect the grounding cable until you have disconnected all other cables.

### **Cleaning Requirements**

- Before cleaning the device, stop using it and disconnect it from the power supply.
- Use a piece of soft, dry and anti-static cloth to clean the device.
- Keep the power plug clean and dry. Using a dirty or wet power plug may lead to electric shock or other perils.



## Appendix A - Time Zones

Time Zone	Time Zone Name
- 11:00	Samoa
- 10:00	United States-Hawaii-Aleutian
- 09:30	French Polynesia
- 09:00	United States-Alaska Time
- 08:00	Canada(Vancouver, Whitehorse)
- 08:00	Mexico(Tijuana, Mexicali)
- 08:00	United States-Pacific Time
- 07:00	Canada(Edmonton, Calgary)
- 07:00	Mexico(Mazatlan, Chihuahua)
- 07:00	United States-Mountain Time
- 07:00	United States-MST no DST
- 06:00	Canada-Manitoba(Winnipeg)
- 06:00	Chile(Easter Islands)
- 06:00	Mexico(Mexico City, Acapulco)
- 06:00	United States-Central Time
- 05:00	Bahamas(Nassau)
- 05:00	Canada(Montreal, Ottawa, Quebec)
- 05:00	Cuba(Havana)
- 05:00	United States-Eastern Time
- 04:30	Venezuela(Caracas)
- 04:00	Canada(Halifax, Saint John)
- 04:00	Chile(Santiago)
- 04:00	Paraguay(Asuncion)
- 04:00	United Kingdom-Bermuda(Bermuda)
- 04:00	United Kingdom(Falkland Islands)
- 04:00	Trinidad&Tobago
- 03:30	Canada-New Foundland(St.Johns)
- 03:00	Denmark-Greenland(Nuuk)
- 03:00	Argentina(Buenos Aires)
- 03:00	Brazil(no DST)
- 03:00	Brazil(DST)
- 02:30	Newfoundland and Labrador
- 02:00	Brazil(no DST)
- 01:00	Portugal(Azores)
0	GMT
0	Greenland
0	Denmark-Faroe Islands(Torshavn)
0	Ireland(Dublin)
0	Portugal(Lisboa, Porto, Funchal)
0	Spain-Canary Islands(Las Palmas)
0	United Kingdom(London)
0	Morocco
+ 01:00	Albania(Tirane)
+ 01:00	Austria(Vienna)
+ 01:00	Belgium(Brussels)
+ 01:00	Caicos
+ 01:00	Chad
+ 01:00	Spain(Madrid)
+ 01:00	Croatia(Zagreb)
+ 01:00	Czech Republic(Prague)
+ 01:00	Denmark(Kopenhagen)

Time Zone	Time Zone Name
+01:00	France(Paris)
+01:00	Germany(Berlin)
+01:00	Hungary(Budapest)
+01:00	Italy(Rome)
+01:00	Luxembourg(Luxembourg)
+01:00	Macedonia(Skopje)
+01:00	Netherlands(Amsterdam)
+01:00	Namibia(Windhoek)
+02:00	Estonia(Tallinn)
+02:00	Finland(Helsinki)
+02:00	Gaza Strip(Gaza)
+02:00	Greece(Athens)
+02:00	Israel(Tel Aviv)
+02:00	Jordan(Amman)
+02:00	Latvia(Riga)
+02:00	Lebanon(Beirut)
+02:00	Moldova(Kishinev)
+02:00	Russia(Kaliningrad)
+02:00	Romania(Bucharest)
+02:00	Syria(Damascus)
+02:00	Turkey(Ankara)
+02:00	Ukraine(Kyiv, Odessa)
+03:00	East Africa Time
+03:00	Iraq(Baghdad)
+03:00	Russia(Moscow)
+03:30	Iran(Teheran)
+04:00	Armenia(Yerevan)
+04:00	Azerbaijan(Baku)
+04:00	Georgia(Tbilisi)
+04:00	Kazakhstan(Aktau)
+04:00	Russia(Samara)
+04:30	Afghanistan(Kabul)
+05:00	Kazakhstan(Aqtobe)
+05:00	Kyrgyzstan(Bishkek)
+05:00	Pakistan(Islamabad)
+05:00	Russia(Chelyabinsk)
+05:30	India(Calcutta)
+05:45	Nepal(Katmandu)
+06:00	Kazakhstan(Astana, Almaty)
+06:00	Russia(Novosibirsk, Omsk)
+06:30	Myanmar(Naypyitaw)
+07:00	Russia(Krasnoyarsk)
+07:00	Thailand(Bangkok)
+08:00	China(Beijing)
+08:00	Singapore(Singapore)
+08:00	Australia(Perth)
+08:00	Russia(Irkutsk, Ulan-Ude)
+08:45	Eucla
+09:00	Korea(Seoul)
+09:00	Japan(Tokyo)
+09:00	Russia(Yakutsk, Chita)
+09:30	Australia(Adelaide)
+09:30	Australia(Darwin)
+10:00	Australia(Sydney, Melbourne, Canberra)
+10:00	Australia(Brisbane)
+10:00	Australia(Hobart)

---

<b>Time Zone</b>	<b>Time Zone Name</b>
+ 10:00	Russia(Vladivostok)
+ 10:30	Australia(Lord Howe Islands)
+ 11:00	New Caledonia(Noumea)
+ 11:00	Russia(Srednekolymk Time)
+ 11:30	Norfolk Island
+ 12:00	New Zealand(Wellington, Auckland)
+ 12:00	Russia(Kamchatka Time)
+ 12:45	New Zealand(Chatham Islands)
+ 13:00	Tonga(Nukualofa)
+ 13:30	Chatham Islands
+ 14:00	Kiribati



# Index

## A

About This Guide [v](#)  
 Account Management [84](#)  
 Account Registration [84](#)  
 ACD [156](#)  
 Adding Contacts [41](#)  
 Administrator password [32](#)  
 Anonymous Call [134](#)  
 Anonymous Call Rejection [135](#)  
 Answering Calls [100](#)  
 Area Code [91](#)  
 Attaching Stand [12](#)  
 Audio Settings [33](#)  
 Auto Answer [100](#)  
 Auto Redial [105](#)

## B

Backlight [27](#)  
 Basic Network Settings [21](#)  
 Blacklist [56](#)  
 Block Out [92](#)  
 Bluetooth [67](#)  
 Busy Lamp Field (BLF) [137](#)  
 BLF List [140](#)

## C

Call Completion [106](#)  
 Call Forward [115](#)  
 Call Mute [109](#)  
 Call History Management [61](#)  
 Call Hold/Resume [110](#)  
 Call Park [129](#)  
 Call Pickup [130](#)  
 Call Recording [140](#)  
 Call Transfer [123](#)  
 Call Waiting [125](#)  
 CE Mark Warning [vi](#)  
 Conference [126](#)  
 Contact Management [36](#)  
 Contrast [27](#)  
 Copyright [v](#)  
 Customizing Your Phone [25](#)

## D

Declaration of Conformity [vi](#)  
 Deleting Contacts [46](#)  
 Dial-now [89](#)  
 Dial Plan [87](#)  
 Do Not Disturb (DND) [110](#)  
 Documentation [7](#)  
 DSS Keys [74](#)

## E

Editing Contacts [45](#)  
 Ending Calls [102](#)

## G

General Settings [25](#)  
 Getting Started [9](#)

## H

Hardware Component Instructions [1](#)  
 Headset Use [65](#)  
 Headset Mode Activation/Deactivation [65](#)  
 Hotline [94](#)  
 Hot Desking [144](#)

## I

Icon Instructions [3](#)  
 Importing/Exporting Contact lists [53](#)  
 In This Guide [v](#)  
 Incoming Intercom Calls [147](#)  
 Intercom [146](#)

## K

Key as Send [33](#)

## L

Language [28](#)  
 LED Instructions [4](#)  
 Limitation of Liability [173](#)  
 Line Keys [74](#)  
 Live Dialpad [93](#)  
 Local Conference [126](#)  
 Local Directory [38](#)

## M

Message Waiting Indicator [160](#)  
 Messages [156](#)  
 Multicast Paging [149](#)  
 Multiple Line Keys per Account [85](#)  
 Music on Hold [155](#)

## N

Network Conference [127](#)  
 Network Connection [12](#)

## P

Packaging Contents [9](#)  
 Phone Initialization [14](#)  
 Phone Installation [12](#)  
 Phone Status [19](#)

Phone User Interface 5  
Placing Calls 98  
Placing Calls to Contacts 49  
Programmable Keys 82

## O

Outgoing Intercom Calls 147  
Overview 1  
Optional Accessories 10

## R

Recent Call In Dialing 102  
Redialing Numbers 102  
Registration 15  
Regulatory Notices 173  
Remote Phone Book 58  
Replace Rule 88  
Ring Tones 34  
Recall 108

## S

Safety Instructions 173  
Search Source List in Dialing 51  
Searching for Contacts 50  
Semi-attended Transfer 123  
Service Agreements 173  
System Customizations 65

## T

Touch Screen Display 15  
Time & Date 29  
Time Zones 175  
Troubleshooting 163

## U

User Interfaces 5

## V

Voice Mail 158  
Volume 33

## W

Warranty vi  
Wallpaper 25  
Web User Interface 5  
WEEE Warning vii