

Brave – Door Entry System

Brave SlimDP - 01

Brave SlimDP - 02

Brave SlimDP - 04



User and Service Manual
Version 2.6

Welcome

Congratulation on purchasing the Brave SlimDP 'BRAVE Slim Door Phone', which is a continuation of the successful SlimDP 'Slim Door Phone'.

The Brave SlimDP is a universal project with the title "BRAVE" with different designs bringing a wider spectrum of functions and possibilities.

This manual is for the following options:

Brave SlimDP – 01	- 1 button
Brave SlimDP – 02	- 2 buttons
Brave SlimDP – 04	- 4 buttons

Basic functions of the new line

- Electronic volume control without the need to open the front cover;
- Programmable tone detection for call disconnection or repeat calls;
- Programming with a DTMF phone or USB cable from a PC;
- 24 digit telephone numbers including * # Flash and Pause;
- LED backlit name tags;



Manual Version V2.6 22.10.2013

Alphatech Technologies s.r.o.

Jeremenkova 88

140 00 Praha 4

Czech Republic, EU

www.alphatechtechnologies.cz

Table of Contents

1	BASIC FEATURES	6
1.1	FEATURES	6
1.2	TERMINOLOGY	7
1.3	BRAVE SLIMDP VERSIONS AND DIFFERENCES	8
1.4	UNIT FEATURES.....	8
2	INSTALLATION	9
2.1	OPENING, WIRING, WALL MOUNTING AND SETTINGS	9
2.1.1	<i>Name card panel</i>	9
2.1.2	<i>Uncover control elements</i>	9
2.1.3	<i>Wiring and wall mounting</i>	10
2.1.4	<i>Switches</i>	12
2.1.5	<i>Voice level</i>	13
2.2	LOCATION OF DOORPHONE COMPONENTS	14
2.3	CHANGING NAME CARDS	15
2.4	FINAL CLOSING OF DOORPHONE.....	15
2.4.1	<i>Covering control elements</i>	15
2.4.2	<i>Replacing name card panel</i>	15
2.5	CONNECT THE KEYBOARD	16
2.6	CODE RELAY (COSW).....	17
2.7	OTHER ACCESSORIES.....	18
2.7.1	<i>Time Relay</i>	18
2.7.2	<i>Power supply 12V AC</i>	18
2.7.3	<i>Power supply 12V DC</i>	18
2.7.4	<i>USB Programming cable</i>	18
3	DOOR ENTRY SYSTEM OPERATION	19
3.1	SIGNALLING OVERVIEW	19
3.2	CALLER AT THE DOOR.....	19
3.3	RELAYS REGIMES	21
3.4	PERSON IN THE BUILDING.....	21
3.4.1	<i>Outbound call</i>	21
3.4.2	<i>Incoming call</i>	22
3.4.3	<i>Door Entry System with keyboard – module SlimKey</i>	22
4	PARAMETER PROGRAMMING	23
4.1	PROGRAMMING WITH THE HELP OF A PHONE	23
4.1.1	<i>Entry into the programming</i>	23
4.1.2	<i>Parameter programming</i>	23
4.2	PROGRAMMING WITH THE HELP OF A PC – PROGRAMME BRAVESET	24
5	DESCRIPTION OF PROGRAMMABLE PARAMETERS	25

5.1	DIRECT DIALLING - MEMORY	25
5.2	RELAYS	26
5.3	BASIC PARAMETERS	31
5.4	TIME PARAMETERS	33
5.5	SYSTEM PARAMETERS	37
5.6	BASIC SETTING AND DELETION	43
5.7	END OF PROGRAMMING	43
5.8	PARAMETER OVERVIEW	44
6	TECHNICAL PARAMETERS.....	47
6.1	ELECTRICAL PARAMETERS	47
6.2	MECHANICAL DIMENSIONS	47
7	TABLE FOR EASY PROGRAMMING.....	48
8	DRILLING MASTER BOARD.....	52

1 Basic features

1.1 Features

- Voice communication is powered from a telephone line
- Impulse and tone (DTMF) options
- Storage of 2 24-digit long numbers per button (including*, #, Flash and pause)
- Option to prolong a call with * or #
- Option to connect one electronic locks, to open doors
- Potential to use up to 6 relay regimes (for electrical lock, an additional bell, lighting etc.)
- Two codes to disconnect the Door Entry System from a phone
- One code to open doors from the phone for 1-impulse and one code for 2-impulse
- 3 x 6 code locks for relay (password from door buttons)
- Can be connected electrically secure lock on the switch (serial activation code - COSW)
- Option to disconnect a call by the repeated pressing of a button
- Option to switch on a 'baby call' regime (no number dialling)
- Option to switch on a regime to suppress the DTMF connection from the microphone
- Option to switch on a 'ticking' sound into a call to announce another call
- Option to switch on acoustic signalling for relay connection
- Option to set the number of rings before connecting a call
- Programmable parameters for tone options Flash length and Pause length
- Programmable parameters for acoustic signalisation
- Programmable parameters for tone detection
- Electronic volume setting without the need to open the front cover
- Version A is with integrated 1W amplifier
- Programmable with PC, via USB cable, and remote DTMF programming
- Integrated regulated heating of the PCB

1.2 Terminology

Telephone line	Analogue (2 conductors) connecting to a public telephone network (public line) or to a local telephone system (local line).
Line connection	The start of a telephone connection (the same as picking up a phone handset).
Line disconnection	End of connection (the same as replacing a phone handset).
Option	DTMF - a tone option combination of two tones (chooses also special signs * and #, uses breaking the loop Flash) Impulsive – option by breaking the loop (chooses only digits)
Incoming call	Connection between a Brave and a phone made by selecting an option on the phone. The Brave connects the call after set number of rings. The Brave can be programmed from the phone following a connection by inputting a password.
Outbound call	Connection between the Brave and a phone made by choosing an option on the Brave (i.e. Pressing a button).
Call connection	Signalled when following the dialled number is picked up. This signal is not available on an analogue line, but the ringing tone ends and a connection begins. It is difficult to identify the exact moment this occurs.
Code lock	Function for relay connections by inputting a combination of up to 4 buttons or keyboard keys (after pressing the key symbol)
Code relay	between Doorphone Brave and the electric lock can be connected code relay (COSW - CodeSwitch), which is located at the lock and lock activates only when is the same the specified serial combination of the Brave and set the code on the board relay (COSW).
External code	Combination of 1-2-or-4 buttons or 10 keyboard keys (after pressing the key symbol) for a relay connection. External = being input on the Brave outside the building
Internal code	Digits combination dial from phone for relay activation (DTMF). Internal = dial by phone – inside building (phone connected to other PBX extension)



The manufacturer continuously improves the product firmware. The technology used allows you to upload to Brave the latest version of the firmware any time using a standard computer with BraveSet and USB cable. The latest version of the firmware is available at www.alphatechtechnologies.cz

1.3 Brave SlimDP versions and differences

The **Brave** door entry system is conceived as system that provides a final solution based on a modular design. The features and parameters that are available to, and can be set, differ for each version of the **Brave**. It is therefore necessary to set the parameters for all versions including any add-on parameters for each version.

Available Features:

basic models:	Brave SlimDP – 01	- 1 button
	Brave SlimDP – 02	- 2 buttons
	Brave SlimDP – 04	- 4 buttons

 Parameters that are not specified in this manual is not recommended to change because they are not available for the version of Brave SlimDP. If you do happen to change a parameter, so it is recommended to make the defaults parameters.

1.4 Unit features

Three versions are available plus keyboard :



Brave SlimDP-01



Brave SlimDP-02



Brave SlimDP-04



Keyboard



Rain hood

2 Installation

This compact unit is fixed by 2 screws to the wall.

2.1 Opening, wiring, wall mounting and settings

2.1.1 Name card panel

1. Every unit is supplied with a special key which is used to release the name cards on the front panel. Push the key into the hole in the speaker grille (see figure - 1).
2. Push the name card panel down and then push it towards to grille (see figure-2).
3. The panel will be released. Pull it towards you to remove (see figure – 3).

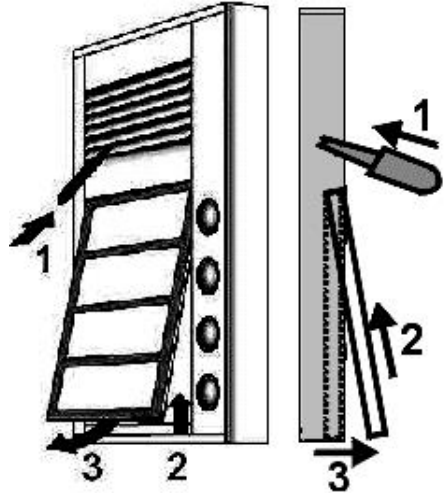

2.1.2 Uncover control elements

4. Push the aluminium speaker grille down (see figure – 4).

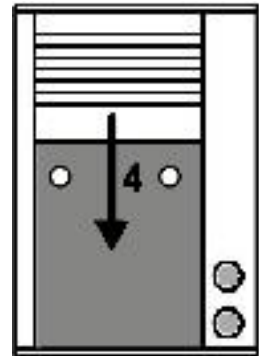

2.1.3 Wiring and wall mounting

5. Use the wall mounting template at the end of the manual to mark the position for the screw holes and cable connection on the mounting surface. Drill the holes.

6. Feed the cable (analogue line, power supply, lock – see figure - 6) through the cable hole.

Fix the panel to the wall using the screws and rawplugs supplied.

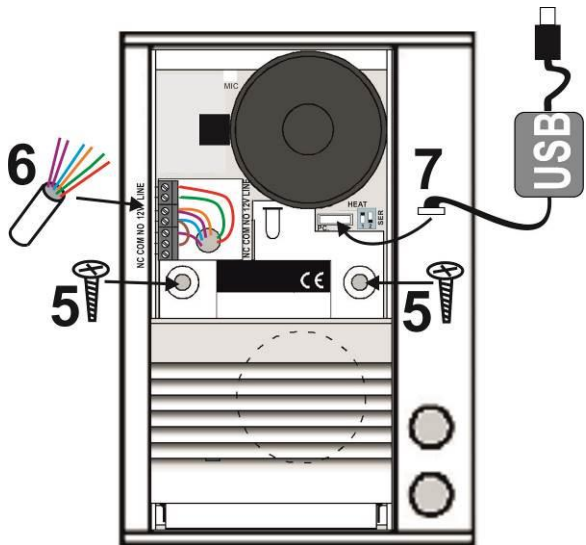

Drill draw is on page 52

Note: Some materials such as metal and wood may require special screw types.

To power the unit for voice, connect the telephone wires into the terminal (on the right side). Using either a standard analogue phone line or an analogue extension on a PBX.

For the external power supply, connect to the terminal "12V" external power supply AC min. 10V / max. 18V or DC min. 12V / max. 24V.

The energy consumption of a connected electrical (magnetic) lock (0,5A – 1,0A) determines the load on the power supply. If you activate the heating feature the PCB current will climb to about 150mA. We recommend power supply AC 12V/1A for normal version and we recommend power supply DC 12V/1A for version with amplifier.

The wiring of relay contacts is explained in the next picture. The symbol "NO" means contact normally open, "COM" means sharing output (central) and "NC" means contact normally closed. The relay contact is isolated from the other circuits on the board. For the variants of lock connection see the picture below.

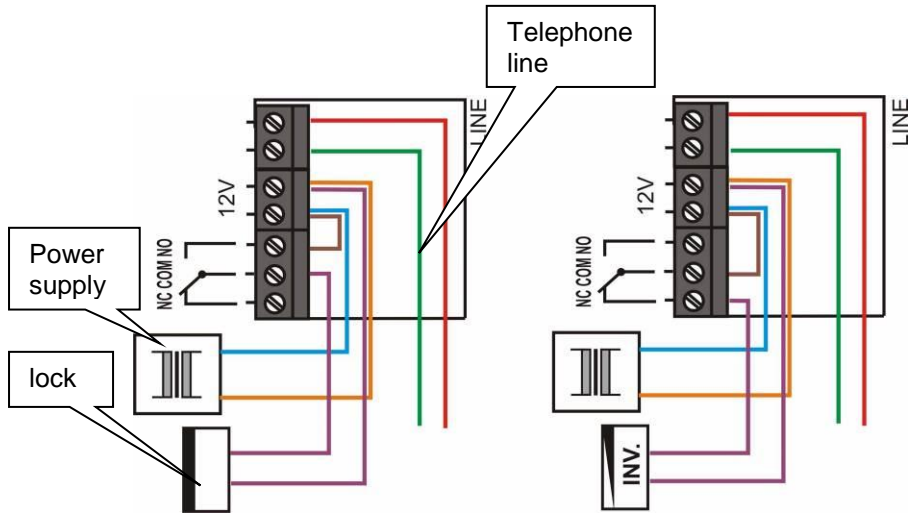

Wiring of **standard** and **magnetic (inverse)** lock

7. A special USB cable enables the doorphone to be connected to a PC for programming of individual parameters. A dedicated Windows program is included on the CD (requires version W98SE or higher).



Under no circumstances use 120V or 230V direct current (DC)! This can be solved by the use of contactors (power relays).

2.1.4 Switches

8. The switch marked **HEAT** (see figure – 8) activates **heating** of the PCB. This is for increased resistance against humidity. To use this feature you must connect an external 12V power supply.
9. The switch marked **SERVICE** (see figure – 9) is required for programming the unit when the password is forgotten. It is performed by ordinary phone (DTMF – tone dial).

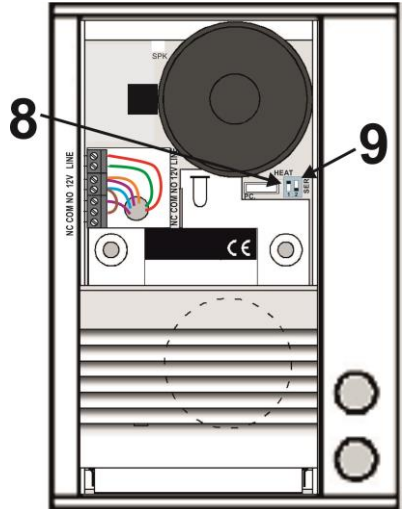
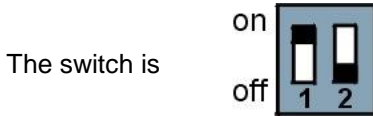

The PCB heating has two major benefits. Firstly, it warms the board during winter time (temperatures under -20 C, most circuits have warranty operation down to -20 C) and secondly it helps to protect the PCB against humidity when installed outside.

! *Note:* Door entry system Brave SlimDP is designed in such a way that it is possible to connect 10-18V AC or 12-24V DC to the terminals 12V (polarity is unimportant). The motherboard heating system has a regulator so that resistors won't burn out at a higher voltage.

2.1.5 Voice level

The principle of setting acoustic paths:

Here we have three parameters 71, 72 and 73. Using the interaction of these parameters can be set to sound in different conditions.

1. quiet environment parameters 71, 72, 73 are set to 7
2. environment where there is a strong ambient noise at the communicator and quiet environment at the phone. Here it is both necessary to reduce the microphone gain (parameter 72 = 1-3) and also change the ratio of the parameters 71/73. We enlarge the parameter (parameter 73 = 11-15) and 71 parameter smaller value (71 = 2-4)
3. environment where there is a strong ambient noise at the phone and quiet environment at the communicator. Here we leave the parameter value of 72 = 7 and 73 and 71 parameters set as follows - parameter 71 = 11 to 14 and 73 = 2 to 4

The principle of setting parameters is - signal from the microphone is amplified by the sum of parameters **72+71 = volume of microphone** and signal to the speaker is amplified by the sum of parameters **71+73 = volume of speaker**. To switch the direction of the ratio is evaluated parameters (**threshold**) 73/72.

- If parameter 72 is greater than the parameter 73, thus favoring the direction from the microphone. We choose when the direction to the phone is interrupted.
- If parameter 73 greater than parameter 72, thus favored direction to the speaker. We choose this if the interrupted sound in the speaker of communicator.

2.2 Location of Doorphone components

All mounting, control and setting elements are located under the speaker front aluminium grille.

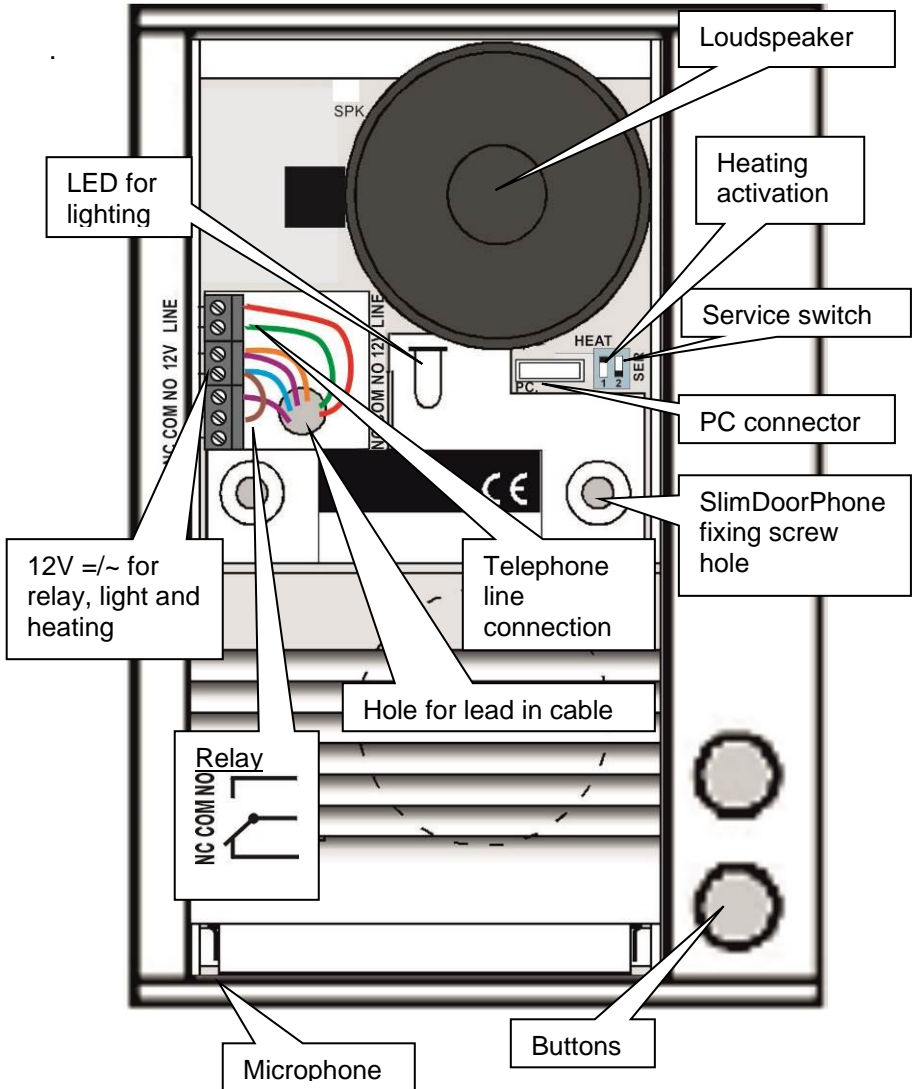

2.3 Changing name cards

Name card panel (2.1.1 on page 9) has spaces to insert printed name cards. Insert name cards from top (see picture). Cards can easily be printed with pictures as well as text using the included software. The card outline is marked for easy cutting .

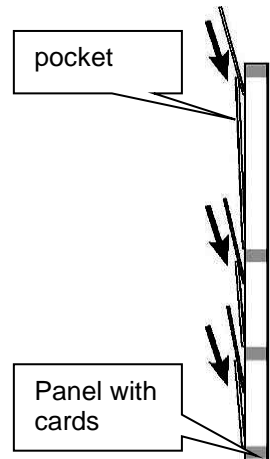

2.4 Final closing of Doorphone

2.4.1 Covering control elements

1. Push aluminium speaker cover back up (see picture). Take care when re-covering the speaker. The aluminium edge of the speaker may be gently pressed if required.

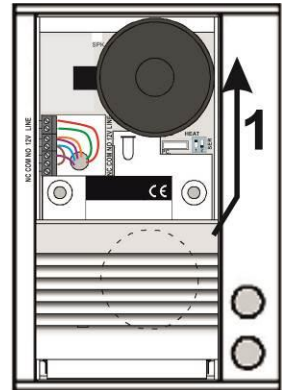

2.4.2 Replacing name card panel

2. Push key into hole in speaker grille as far as possible. (see figure -2).
3. Push name card panel upwards and push the bottom edge in (see figure -3).
4. Push the name card panel back down behind the lip of the casing (see figure -4).

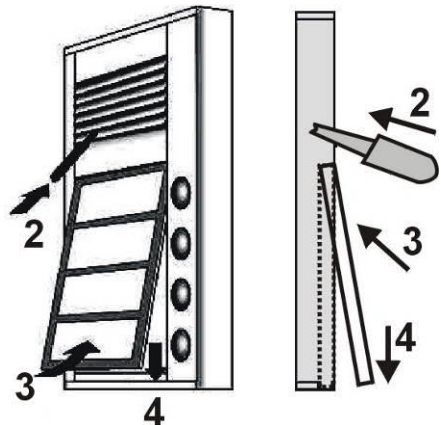

2.5 Connect the Keyboard

Keyboard work as separate code lock, he has connection power supply 12V, input for departure button and one relay with change-over contact. In case connection by special cable keyboard with Doorphone characteristics those code lock expand and keyboard can be use not only to control relay in keyboard, but relay in doorphone Doorphone contol too and use so 10 codes for one and 10 codes for second relay. Further it is possible keyboard use to dialling numbers. Exit button can control one or the other relay and relay in keyboard it is possible control from phone during conversation too (*parameter.30*). Code lock for relay in Doorphone from buttons stays conserved.

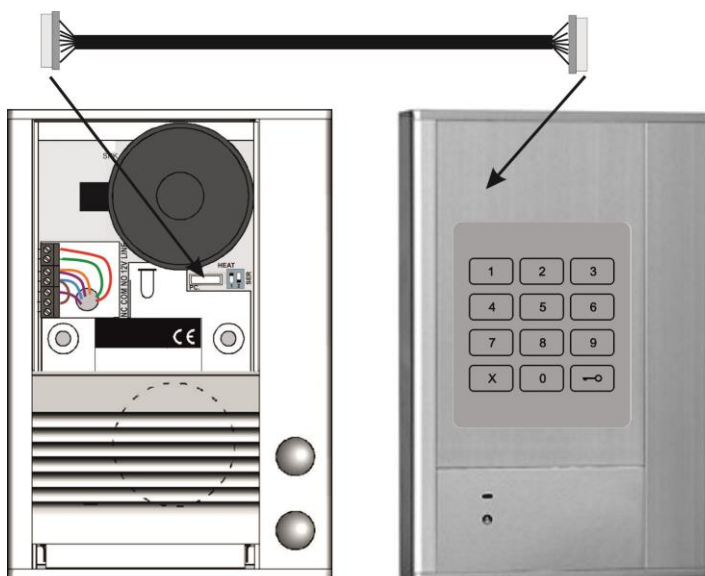

Connection by special cable is make that way will you use programming connectors 8pin. To programming from PC is usings same USB cable USB-KABslim and program ID-Manager is in new version 2010 equipped also by program for setting keyboard.

To basic function is necessary have connected to **Doorphone telephone line** and to keyboard 12V. 12V for heating board and power supply of relay in Doorphone can use from same source and it is possible use also for power supply of locks. Recommended is use low power locks.

The choice is entered by gradual pressing of buttons with digits. Firstly the key symbol must be pressed to enter a password. When pressing **X**, the guard will hang up.

2.6 Code relay (COSW)

For the switch (relay) is available function code relay (COSW CodeSwitch). It serves primarily to secure transmission of information by switching the electric lock. When using this function is not possible connecting or disconnecting the voltage at the terminals to lock this lock activated. Activation is performed only when positive result compared serial information transmitted between Brave and the board code relay

Brave is set in several codes to activate the relay code. Relay can be activated codes for one or two impulses can differentiate activated from the phone (DTMF) or from keys (keyboard). The last option is

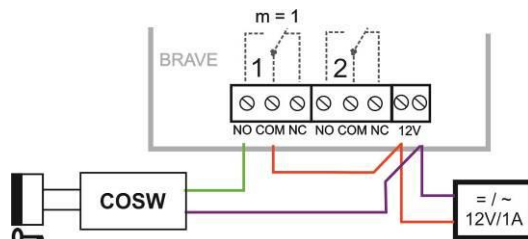

the activation code in another mode switch than the lock.

The code information is 8 bits, but the code is 4 bits with security 4 bits which is total of 8 bits. Practically, this is performed so that after activation the switch is first transmits the serial code, and if they agree, so code relay connects the electric lock.



The code relays can be connected in parallel to increase the number of switches, but can never combine connections electric lock and the code relay parallel!

2.7 Other accessories

2.7.1 Time Relay

The time relay enables wider functionality of the relays. It is a separate product and detailed instructions can be found at www.alphatechtechnologies.cz

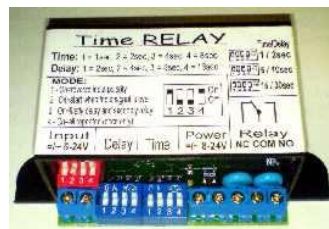

2.7.2 Power supply 12V AC

A 12V/1A AC alternative power supply is recommended for the Brave SlimDP normal version. This is not a part of delivery and must be ordered separately. Further details of power supplies and electric locks can be found at www.alphatechtechnologies.cz



2.7.3 Power supply 12V DC

A 12V/1A DC alternative power supply is recommended for the Brave SlimDP version with **amplifier**. This is not a part of delivery and must be ordered separately. Further details of power supplies and electric locks can be found at www.alphatechtechnologies.cz



2.7.4 USB Programming cable

The USB cable is the same as that used for the SlimDP door entry system. The USB drivers can be found on the web site www.alphatechtechnologies.cz















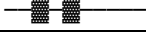

3 Door Entry System Operation

The Brave SlimDP door entry system's functions are set by establishing parameters (see the chapter on parameter programming page 23).

3.1 Signalling overview

Brave SlimDP acoustic signals that occur during its operation. Samples of sounds can be listened to in the setting programme 'BraveSet'.

State	Tones	Tone frequency
Pick up line type 1		980-1333-1650
Disconnection of line type 1		1650-1333-980
Pick up line type 2		800-1067-1200-1333
Disconnection of line type 2		1333-1200-1067-800
Confirmation of command from the phone		800
Ticking during a call		
Notice about the end of a call		1333
Relay switch signal		Modulated
Entry into programming from the phone		980-1067-1180
Programming from the phone		Modulated
Parameter confirmation		800
Entry into programming from the PC		980-1067-1180
Line connection (Reset)		1850-1067-1850
Error (generally something is not right)		800
Empty memory (no number is programmed)		1300-2100

It is useful to know what tones the Brave SlimDP plays during installation as it will assist in the analysis of its state and operation. The sounds can be turned off in several levels (*parameters 61,62,63 and 65*).

3.2 Caller at the door

The door entry system's buttons are labelled in the same way as normal doorbell buttons. Visitor finds the appropriate name (for example Mr Smith)

and presses the button. The Brave will pick up a line, "plays" the pick up line tone (if it is not prohibited *para.62*) and dials the phone number saved under that button (*parameter 1 or 2* depending on system regime). From the Brave's speaker a ringing tone will be heard and Mr Smith's phone will ring. As soon as Mr Smith picks up he can talk to his visitor. If an electric lock is also connected to the Brave, Mr Smith can press a DTMF code on his phone and let visitor in. If he puts down the phone the Brave will disconnect. If the call lasts longer than the pre-set limit (*parameter 52*), 10sec before disconnection the Brave will send a line disconnection tone, but Mr Smith can dial * or # (*parameter 42*), to prolong the call for the length of time set in *parameter 52*.

The dialled number depends on the regime mode, which is set in the system (*parameter 47*):





- **Regime Day/Night** = if the system is in 'Day' mode, it dials the number set in *parameter 1*, if the system is in 'Night' mode, it dials a number set in *parameter 2*. The switching over of regimes manually is set in *parameters 45,46*.
- **Regime 2 groups** of numbers = the first press of the button always dials a number set in *parameter 1*. Following the repeated pressing of the same button, when it detects a busy tone (10sec after choice), or after a pre-set number of rings (*parameter 56*) the system dials a number from the second group (*parameter 2*). After another press of the same button the system will again dial the number from the first group (or after detecting a busy tone on the dialling of a number from the group 2 the repetition ends).

If a visitor presses the button after the system has picked up, the system will disconnect for a length of time as set in *parameter 54* before it picks up the line and dials a new number. The number choice takes place either by tone (DTMF) or impulse according to the setting in *parameter 41*. There is one more option, disconnection of line after repeat pressing of the same button (*parameter 4**).

It is possible to control a relay switch (**code lock**) with the first 4 buttons. If visitor at the door presses buttons in the correct combination according to a pre-programmed code (*parameter 32-34*) and the length of time between presses isn't greater than the pre-set time (*parameter 53*) the system picks up, switches the appropriate relay (if it is set in mode $m=1$) for the length of time given in *parameter 37 or 39,30* and then disconnects.

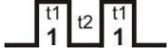
Relays can switch on one or two impulses depending on control code with the length of time between impulses set in *parameter 30*. See Tab. 1.

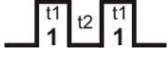
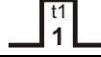
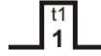
3.3 Relays regimes

Regime $m = 1$ (parameter 3111 and 3121)			
Action	Note	Parameter	Relay
Evaluation of correct internal code from the buttons	According to setting Day/Night	3211-3215	
		3311-3315 3411-3415	
	According to setting Day/Night	321*	
		331* 341*	
Internal code from the phone	Option to choose 1 or 2 digits of code 2 digit code is basic and it is possible to shorten it by using * in the first place of code during programming	351	
		361	
Regime $m = 4$			
Action	Note	Parameter	Relay
Press buttons	Any number of button other than in 311*	3114	
	Button set in 311*	3114	
Regime $m = 6$			
Action	Note	Parameter	Relay
Press of the button	Any number of button other than in 311*	3116	-
	Button set in 311* or 312*	3116	

Note t1 – time of connection of relay 1 (parameter 371)
t2 – time between impulses of relay 1 (parameter 301)

Tab. 1 Table of relay controls

3.4 Person in the building

The person in the building means the person who is in telephone contact with the Brave entry system (i.e. Mr Smith).

3.4.1 Outbound call

An outbound call is a call from the Brave system (i.e. started by a visitor). Once the system has been dialled, a phone inside of the building rings and on pick up it is possible to talk to the visitor at the door. By choosing a code it is possible to switch on a relay (parameter 35) if it is set in mode $m=1$, switch over the Day/Night regime (parameter 45, 46) and disconnect the connection (parameter 43). 10sec before the end of the call (parameter 52) the system

sends a notice about the end of the call but choosing a code (parameter 42) it is possible to pro-long the call. By replacing the handset the call is terminated (the switchboard phone will send a system busy tone and the system will disconnect). There is one more option, disconnection of line after repeat pressing of the same button (parameter 4*).

3.4.2 Incoming call

An incoming call is a call to the system (started by a person inside the building). After choosing the branch the system is connected and the line rings, following a set number of rings (*parameter 51*) the system will then pick up and it is possible to speak. The options are the same as an 'outgoing call' (chapter 21)

- One exception is in the first 10sec. when it is also possible to input '#' and a service password' (*parameter 44*) directing the system to go to the programming regime.
- Another exception is during incoming call and DIP1 is switched to on ("SERVIS") when the system also goes to the programming regime (without a service password).
- The final exception is relay controls (*parameter 381*), when an incoming call can disable the relay controls.

3.4.3 Door Entry System with keyboard – module SlimKey

If a keyboard module is connected to the system, then it is necessary to set the following parameters:

Parameters for control second relay is in parameters same for relay 1 (inside Brave SlimDP), but with index relay 2.

For using features in SlimKey is need set in SlimKey parameter – "connection with SlimDP" to "on". Next is possible dial telephone numbers from keyboard and control relay 1 by code from SlimKey and from exit button connected on SlimKey. This settings is on SlimKey, in Brave SlimDP is connection with SlimKey detected automatically.

4 Parameter programming

4.1 Programming with the help of a phone

4.1.1 Entry into the programming

There are two ways to enter the Brave's programming system:

1. **With the help of a password** –incoming calls only! – pick up a phone and dial the number that the Brave is connected to (*either the number of the branch, if you are connected to a switchboard line, or the number of the line to the building, where the Brave is and ask be connected to the branch to which the Brave is connected*). The brave will pick up (you will hear the pick-up tone – see chapter 3.1 page 19) within 10 secs. press '**#xxxx**', where xxxx is the service password to enter the programme system (*in the basic setting xxxx=0000*), if correct there will be a programming entry tone followed immediately by a programming tone (see chapter 3.1 page.19).
2. **With the help of DIP 1 "SERVICE"** –incoming call only! – connect to the Brave as in part 1 above, but where the DIP switch is in position 1 "on", the Brave will go straight to the programming regime – you will hear the pick-up tone for entry to programming followed immediately by the programming tone (see chapter 3.1 page.19).
Do not forget to put DIP switch to position "off" at the end.

4.1.2 Parameter programming

The default state for programming is announced with a programming tone, the Brave always returns to this state after a specified time (5sec), whether you started programming or not.

There are two types of parameters used during programming. These are parameters with a **fixed length**, which is the majority of them, when programming is confirmed after it fulfils the mandatory length and is immediately 'written in' with a **confirming tone** and parameters **with variable length** (*parameters 1,2,32,33,34*) when the **confirmation** is made only after time of inaction (5 sec). The only case when there is an immediate 'writing in' of parameters is when the maximum number of 'written in' signs (numbers) are filled up, for parameters 1 and 2 it is 24, for parameters 32,33,34 it is 6.

If you input a number (sign) that is unacceptable during the programming the Brave immediately sends an **error tone**, the parameter is not 'written in' and the Brave reverts to a default state where it is possible to either repeat the parameter programming or start programming a different parameter.

The Brave will automatically disconnect form the programming regime after a period of inaction, 30 sec. With each DTMF tone dialled the time will always resets to 30 sec. It is also possible to end the programming regime by choosing parameter 9.

Note. *If you want to keep a connection opened during the programming (prolong the 30 sec time) regime (i.e. before a customer decides what else he wants to be set) then you can press * or #, the Brave immediately answers with an error tone but will prolong the time before disconnecting.*

4.2 Programming with the help of a PC – programme BraveSet

To programme the Brave with the PC you will; need to use the special cable USB-KABslim and programme BraveSet. The Brave will also need to be connected to a telephone line.

Procedure:

- Connect the Brave SlimDP to the line;
- Connect Brave SlimDP to the PC via the USB cable. The Brave will pick up a line and within 3 seconds a tone for programming entry will be heard (see chapter 3.1 Page.19).
- Run programme BraveSet. Until the USB is disconnected the Brave is connected to the PC and is in programming regime and will not run any other operations. If you lose connection, you will need to reconnect the USB cable – the Brave will then pick up.
- Connection between the Brave and the programme is indicated by the firmware on the bottom.

For ease of orientation the parameters in the BraveSet programme are marked with the same codes as per the phone programming.

The details about parameter setting can be found in 'help' of the programme.

5 Description of programmable parameters

Parameters always start with a fixed/mandatory part (address) followed by a variable part, which is your choice. The range and explanation is always under the table, sometimes with examples. Everything is dialled exactly as it is shown in the table, nothing needs to be confirmed in any way, after writing into a memory a confirmation tone can be heard and if an incorrect value is input then an error tone will be heard.

5.1 Direct dialling - memory

Parameter	Value	Meaning	Basic
1	tt nn...	number nn under button tt	-

tt – button number (memory), always input 2 digits [01-04]

nn – telephone number as long as 24 digits that are to be saved. For saving of other sign choices always use the assignation as per the table.

Numbers saved in parameter 1 are numbers of the **first group**, or numbers of the regime **Day**.

Basic settings never change or delete these saved numbers.

meaning	choice
0 - 9	0 - 9
#	#
*	**
Flash	* #
Pause	* 0

Parameter	Value	Meaning	Basic
2	tt nn...	number nn under button tt	-

tt – button number (memory), always input 2 digits [01-04]

nn – telephone number as long as 24 digits that are to be saved. For saving of other sign choices always use the assignation as per the table.

Numbers saved in parameter 2 are numbers of the **second group**, or numbers of the regime **Night**.

Basic setting never change or delete these saved numbers.

meaning	choice
0 - 9	0 - 9
#	#
*	**
Flash	* #
Pause	* 0

Note. The Day/Night regime switch over remains set in the Brave even after a line disconnection.

Examples of setting:

1. first button is supposed to dial 358 during the day and 0603441296 during the night, then the programming is - 101358 and wait for 🎵, then 2010 *0 603441296 and wait for 🎵
2. second button is supposed to dial 123#1*2Flash3 during day and night, then the programming is 102123#1 ** 2 *# 3 and wait for 🎵, then 202123#1 ** 2 *# 3 and wait for 🎵

Note. If you are not using regime Day/night or regime 2 groups of numbers, then it is recommended to set regime Day/Night (*parameter 47*) and then set the same code for switching over Day/Night (*parameters 45 and 46*). *His way it is guaranteed that Brave will always be in Day regime and you can only programme telephone numbers for the day regime (parameter 1).*

5.2 Relays

Parameter	Value	Meaning	Basic
31	r m	relay r operates in regime m (1-8)	11 21

r – relay number [1 in SlimDP]

m – relay regime [1-6 – *not m=5*]

regimes **m=1, 4, 5, 6** are explained in detail in Relay Regimes Tab. 1 on page 21

m=1 mode **relay** – switched on with command (internal code) or with a password (external) 1 impulse for length of time t1 (use for electric locks) or 2 impulses when it switches on for time t1, off for t2 and again switches on for t1 (opening of sliding gates).

m=2 is switched on for time when the line is picked up (**camera**) – switches on when system picks up and off when it disconnects.

m=3 is switched on for time when the line is picked up and extra time t1 after disconnection (**lights**) - switches on for time when the line is picked up and extra time t1 after disconnection (for this time the line is busy)

m=4 regime **button** – switched on when any button is pressed and off after t1 (use is for example connection of external bell or siren)

m=6 switches on depending on pressed button (it is set in parameter 31r*). In this way it is possible to choose only **one button** for each relay, which when pressed switches on relay for time t1. This regime is used instead of connecting separate doorbell to the system.

Parameter	Value	Meaning	Basic
31	r* tt	button tt switches on relay r in regime m=6 (01-04)	01

r – relay number relay number [1 in SlimDP]

tt – button number (memory), always in two digits [01-99]

This parameter is only for relay regime m=6. Value tt determines which button starts switching on for time t1 of relay r.

Parameter	Value	Meaning	Basic
32	rp hh...	In regime Day + Night password hh... for relay r , in order p=1-5 for 1 impulse and p=* for 2 impulses (11-444444)	-
33	rp hh...	In regime Day password hh... for relay r , in order p=1-5 for 1 impulse and p=* for 2 impulses (11-444444)	-
34	rp hh...	In regime Night password hh... for relay r , in order p=1-5 for 1 impulse and p=* for 2 impulses (11-444444)	-

r – relay number [relay number [1 in SlimDP]

p – order [1 - 5] for 1 impulse. 5 passwords (external codes) from Brave's buttons (external code of code lock)

p – order = * to set password (external code) for 2 impulses

hh... – password (external code) for relay switching on from button or keyboard [2 to 6 places]. Buttons 1 - 4 are programmed as numbers 1-4.

All together 3x12 passwords, depending on the Day/Night setting, combinations are be input either with the help of the buttons (only butons on panel – max. 4). Switching on a relay is affected by the relay **regime** and the choice **Day/Night**, if the regime **2 groups of numbers** is set, the system is constantly in regime **DAY**.

There are several rules that needs to be followed when setting a password:

- Choose the first button of password from buttons that are the least used for direct dialling (-prolonging time).
- Be mindful about conformity of numbers (i.e. when 1 password contains another.

Note. When setting parameter **32,33,34** signs # and * and 5,6,7,8,9,0 are not used because they are not on the button panel

Parameter	Value	Meaning	Basic
35	r aa	command aa from phone for switching relay r 1 impulse (00-99,*0-*9)	155 266

r – relay number relay number [1 in SlimDP , 2 in SlimKey]

aa – command (internal code) for switching on the relay from the phone [2 spaces] /¹

To set the same commands for both relays (internal code) so that both relays activate at the same time. It is also recommended that the same command is set for 'relay on' and 'command to disconnection of system (*parameter 43*) **aa=bb**.

/¹ – command is always 2 digits, but if you wish to control relay with a single digit from the phone, there is an option to input "***a**", where **a** is a single number and the star represents an empty space and must be in the first place.

Example:

1 relay switch on internal code 48 – is programmed **35148** ♪

2 relay switch on internal code 8 - is programmed **352*8** ♪

By choosing no 8 on the phone we switch on just the second relay, with option 48 we switch on both relays

Note: second relay is in SlimKey module, works only if is SlimKey connected.

Parameter	Value	Meaning	Basic
36	r cc	command aa from phone for switching relay r 2 impulses (00-99,*0-*9)	150 260

r – relay number relay number [1 in SlimDP]

cc – command (internal code) for switching on the relay from the phone [2 spaces]/¹

To set the same command for both relays (internal code) so that both relays activate at the same time

¹ – command is always 2 digits, but if you wish to control relay with a single digit from the phone, there is an option to input "***a**", where **a** is a single number and the star represents an empty space and must be in the first place.

Switching a relay on with 2-impulses is used for sliding gates replacing a gate entry.

Example:

Command for switching on 1st relay 1 impulse is for example ***8**, the command for disconnection is ***8** and the command for switching on 1st relays 2 impulses is ***9**.

Programming: **351*8** ♪ , **431*8** ♪ , **361*9** ♪.

If you are in conversation with the Brave, the command to open a gate would be button **9**, the first impulse starts and the gate opens, the second impulse stops it, the time the gate is opened "opened space" is set by time between the impulses (*parameter 30*) after people enter press **8**, then Brave makes 1 impulse and disconnects, gate closes.

Parameter	Value	Meaning	Basic
37	r ss	time ss [sec] of relay r on for time t1 (01-99)	105 205

r – relay number relay number [1 in SlimDP]

ss – time **t1** for which relay 1 is switched on [2 spaces 00-99], where time 00 means 0,5sec

Parameter	Value	Meaning	Basic
38	r p	relay r control during incoming call (0/1)	11 21

r – relay number relay number [1 in SlimDP]

p – parameter whether it is allowed **p=1** or disallowed **p=0** to control relay during incoming call.

To prohibit 'control' during an incoming call, for use with relay 2 in mode 1 for controlling a garage door, so the electronics open the garage door and the car passing through the door, closes the door. Then control from the phone could result in a permanently opened door (i.e. the door doesn't close because car didn't enter).

Parameter	Value	Meaning	Basic
30	r zz	time zz [sec] between impulses for switching on relay r 2 impulses- time t2 (01-99)	105 205

r – relay number relay number [1 in SlimDP , 2 in Slimey]

zz – time t2 between first and second impulse for switching on relay 1 [2 spaces 00-99], where time 00 means 0,5sec

Parametr	Value	Description	Default
3#0	p	p = 1 enabled / disabled p = 0 connection code relay COSW (0/1)	0

p – turns on transmission serial code to activate the first relay.

CAUTION - at activation this function never connect to the circuit electric lock without board COSW - code relay - threatens to destroy the relay in Brave communicator!

The following codes may be the same or different for the resolution switching on multiple parallel connected relay code.

Parametr	Value	Description	Default
3#1	abcd	activation code 1 pulse from buttons (0000-1111)	0000

abcd – Brave sends a serial code for the code relay (COSW) after evaluation code from keys (keyboard) namely for 1 pulse

Parametr	Value	Description	Default
3#2	abcd	activation code 1 pulse from phone (0000-1111)	0000

abcd – Brave sends a serial code for the code relay (COSW) after evaluation code from telephone (DTMF) namely for 1 pulse

Parametr	Value	Description	Default
3#3	abcd	activation code 2 pulses from buttons (0000-1111)	0000

abcd – Brave sends a serial code for the code relay (COSW) after evaluation code from keys (keyboard) namely for 2 pulses

Parametr	Value	Description	Default
3#4	abcd	activation code 2 pulses from phone (0000-1111)	0000

abcd – Brave sends a serial code for the code relay (COSW) after evaluation code from telephone (DTMF) namely for 2 pulses

Parametr	Value	Description	Default
3#5	abcd	activation code from other modes of switch (0000-1111)	0000

abcd – Brave sends a serial code for the code relay (COSW) after evaluation code from other modes m of relay 1

5.3 Basic parameters

Parameter	Value	Meaning	Basic
41	v	Type of choice v – time/impulse (0/1)	0

v – type of choice **v=0** is DTMF tone choice, **v=1** is impulse choice

Parameter	Value	Meaning	Basic
42	z	Sign for call prolonging (* / #)	*

z – sign for prolonging a call * or # (10secs. before the end of the call the Brave sends signal, after pressing this the Brave prolongs the call)

Parameter	Value	Meaning	Basic
43	g bb	Command for disconnecting Brave from the phone (00-99,*0-*9)	155 266

g – Command order [1-2] (there are 2 to disconnect the Brave from both relays)

bb – Command for disconnecting the Brave from the phone [2 spaces]
/1 It is advantageous to set the same command for relay switching on (*parameter 35,36*) and command for the Brave disconnection **aa=bb** or **aa=cc**.

/1 – command is always 2 digits, but if you wish to control relay with a single digit from the phone, there is an option to input **"*a"**, where **a** is a single number and the star represents an empty space and must be in the first place (*e.g. at parameters 35,36*).

Parameter	Value	Meaning	Basic
44	xxxx	Service password (0000-9999)	0000

xxxx – service password to programme from a phone (DTMF)



If you forget the password, the following procedure is recommended:

1. Open the Brave front cover;
2. Switch 'DIP 2' to 'ON';
3. Call the Brave;
4. Once the Brave picks up the system is in programming regime. In this regime it is possible to change the password 44xxxx;
5. Switch 'DIP 2' to 'OFF'; and
6. Close the front cover.

Parameter	Value	Meaning	Basic
45	dd	Command for switch over to DAY (00-99,*0-*9)	11
46	nn	Command for switchover to NIGHT (0099,*0-*9)	10

Dd command to switch over to the **DAY** regime [2 spaces] /1

Nn command to switch over to the **NIGHT** regime [2 spaces] /1

/1 command is always 2 digits, but if you wish to switch over from Day to Night with a single digit from the phone, there is an option to input "*a", where **a** is a single number and the star represents an empty space and must be in the first place (e.g. parameters 35,36)

Note. The Day/Night switch over regime stays set following line disconnection.

Parameter	Value	Meaning	Basic
47	e	Regime system choice (0/1)	1

e – Choice of regime numbers; **e=0** selects numbers from first and second group, **e=1** selects numbers in accordance with the **Day/Night** regime.

 **WARNING !!** setting this parameter materially affects the number dialling!

Parameter	Value	Meaning	Basic
4*	k	Line disconnection function by repeatedly pressing a button (0/1)	1

k – Line disconnection by repeated pressing of the same number:

k=0 function is disabled; and

k=1 repeatedly pressing the same button to disconnect the line.

 **WARNING !!** setting of this parameter materially affects number dialling!

5.4 Time parameters

Parameter	Value	Meaning	Basic
51	q	Number of rings before the Brave picks up (1-9)	2

q – The number of rings before an incoming call is picked up. The Brave picks up between rings 2 secs. after detecting the **q**-th ring. It is possible to set the number of rings between 1 and 9.

Parameter	Value	Meaning	Basic
52	d	Maximum length of a call (0-9,*,#)	2

d – The maximum length of time for which the Brave is busy. It is possible to prolong this time during the call by choosing a key (* or #) from the phone (*parameter 42*). The setting of this time is in accordance with the adjacent table.

Time [min]	Option
0,5	0
1 - 9	1 - 9
15	*
30	#

Parameter	Value	Meaning	Basic
53	w	Time between button presses (1-9)	2

w – maximum time [in seconds] between button presses [range 1 - 9]

- **Normal buttons**

- **Relay switch on** – if the time between presses is longer than time **w**, then the code will not work correctly.
- **Choice of number** – if the pressed button is the first number of a password to switch on a relay then the choice is delayed by time **w**.

Parameter	Value	Meaning	Basic
54	z	Time of disconnection for repeat dialling (1-5)	2

z – Time [secs.] the Brave disconnects before it picks up again for repeat dialling (press of a button during a call, detection of busy tone) [range 1-5].

Parameter	Value	Meaning	Basic
55	z	Time before commencing a choice (1-5)	1

z – Time [sec] after the Brave picks up, before it commences a choice [range 1-5]. This time is different for each switchboard phone system, but generally most operate within 2 seconds after a line is picked up.

Parameter	Value	Meaning	Basic
56	hh	Number of rings before it disconnects (04-99)	12

h After the choice finishes it will start counting CRT (control ringing tones), if the number is higher than **hh**, then it will disconnect [range 04-99]. It repeats the choice if the regime of dialling 2 groups of numbers is set.

Parameter	Value	Meaning	Basic
500	x	Medium frequency of tone detector (1-0)	3 (375-475Hz)
501	y	Number of busy tones (2-0)	4
502	z	Time length of permanent tone (1-5)	3 (3s)

x Medium frequency of tone detector is set if there is a non-standard signal from the telephone switchboard.

y Minimum number of busy tones necessary for detection [2-0], where 0 means 10 busy tones.

z Minimum length of time of a permanent tone (for detection of notification tone at branch switchboard) [1-5 sec].

frequency [Hz]	x - choice
275-375	1
325-425	2
375-475	3
425-525	4
475-575	5
525-625	6
575-675	7
625-725	8
675-775	9
725-825	0

Parameter	Value	Meaning	Basic
503	tt	Tone length of time for DTMF (tone) choice (04-16)	10 (100ms)
504	mm	Time of gap between DTMF tones (04-16)	10 (100ms)
505	f	Length of flash time (1-6)	1 (100ms)
506	p	Length of time of pause/digit gap (1-0)	4 (800ms)

- tt** Length of DTFM tone choices is specified by the formulae:
(the entered number) x 10 = time length of tone [ms]
[range 04-16 which is 40-160ms]
- m** Length of gap between DTMF tone choices is specified by the formulae:
(the entered number) x 10 = time length of gap [ms]
[range 04-16 which is 40-160ms]
- f** Length of flash is specified by the formulae:
the entered number x 100 = time length Flash [ms]
[range 1-6 which is 100-600ms]
- p** Length of pause is specified by the formulae:
the entered number x 100 + 400 = time length of pause [ms]
[range 1-0 which is 500-1400ms]
- Time **p** is the simultaneously length of gap between button taps for an impulse choice.

Parameter	Value	Meaning	Basic
507	uu	Transmit level of DTMF choice v [-dBm] (04-16)	10

- uu** Transmission level of (DTMF) choice to the line, the range is -4 to -16dBm, input the required level where uu=04 is -4dBm, uu=10 is -10dBm

Parameter	Value	Meaning	Basic
508	p	preemphasis DTMF (0/1)	0
509	S	Listening in DTMF – level (1-4)	2

p Preemphasis is the ratio of the upper and lower groups of DTMF frequencies. It is possible to choose ratio 2.2 dB - p=0 (Europe) or ratio 3.2dB - p=1 (Australia)

s Choice of **DTMF** volume levels (4 levels):

Volume in DTMF [dB]	s - choice
-15	1
-9	2
-3	3
+3	4

5.5 System parameters

Parameter	Value	Meaning	Basic
61	z	Acoustic signals (confirmation, error, empty memory, end of call) (0/1)	1

The Brave's comes with standard acoustic signals. However, using parameter "z" it is possible to switch off the acoustic signals. The values are:

z=0 Acoustic signals **off**; and

z=1 Acoustic signals **on**.

Parameter	Value	Meaning	Basic
62	v	Acoustic signals introduction/conclusion (0/1/2)	1

The acoustic signals for the connection and disconnection of a line are standard, but this may cause false choices with some phone systems. So using parameter "v" it is possible to switch off these signals. The values required are:

z=0 Introduction/conclusion signalisation is off;

z=1 Pick up and disconnection signalisation on (intro/concl.- type1);

z=2 Pick up and disconnection signalisation on (intro/concl.- type2).

Parameter	Value	Meaning	Basic
63	u	Acoustic ticking signal during a call (0/1)	0

Ticking during a call is switched off as standard. However, by switching it on you can differentiate on the switchboard a call from the Brave by a faint ticking. The values are:

u=0 Ticking into a call is off

u=1 Ticking into a call is on

Parameter	Value	Meaning	Basic
65	z	Acoustic signals for switching on a relay (0/1)	0

The signal for switching on a relay is standard, **z=0**. However, it is possible to use this function when using a uni-directional supply 12V, so when the door lock is open there is **no** buzzing so the person at the door won't know the door is open. When set to **z=1** the time the relay is switched (door open) then there is a specific sound.

Note1 This function is available only for regimes **m=1**

Note2 During the relay switch-on (2 impulses) there is acoustic signal for the whole time of the sequence (even during gap between impulses).

Parameter	Value	Meaning	Basic
66	i	Suppression of the reception DTMF from the microphone (0/1)	0

Suppression of the reception DTMF from the microphone is off as a default **i=0**. It is possible to open the door with a personal dialler without disturbing a person inside the building. For higher security it is possible to switch on the suppression function **i=1** and stop a person with an unauthorised copy of the DTMF code from entering.

Parameter	Value	Meaning	Basic
67	b	Baby Call – call without the need to programme a telephone number (0/1)	0

This function is turned **off** as standard **b=0**. By switching on this function **b=1** the acoustic signal for an empty memory is cancelled, so after pressing a button with an empty memory there is only a beep (confirmation) and a call is activated as if there were a number.

Warning: During the first 10 seconds of a call the tone detector is inactive (there is a pause before the switchboard responds or number dialling by the switchboard).

Parameter	Value	Meaning	Basic
68	b	Mute at the lock activated (0/1)	0

Default is off **m = 0** By enabling the **m = 1** mutes the acoustic path at close relay (1 or 2) in "electric lock" (modes 1 and 5). This feature is there because if you often use code lock function or exit button, so the switch-on time to hear the tone exchange. For some customers, this can be distracting.

Parameter	Value	Meaning	Basic
6#	s	Setting of the number of buttons on the main panel.	2

This constant serves a purpose to identify the no.1 button in the composition of the module. After entering the number of buttons **s** the button no 1 is moving so it is always first.

Number of buttons on the main panel	s - choice
1	1
2	2
4	4

 **WARNING !!** setting this parameter materially affects number dialling.

Parameter	Value	Meaning	Basic
6*	t	Delayed start for switchboards with line testing (Siemens) (0/1)	0

This function is off as standard **t=0**. By switching this function on **t=1** the processor goes into sleep mode immediately after the line connection, and after 3 secs. The Brave initialises. The line connection after the power supply connection is then delayed - state switching on/restarting of the switchboard. If this function is not working and the telephone switchboard still identifies a line fault, then there is no other option but to use :

- BestBox (external module)
- module SlimKeyboard (include permanent power doorphone from 12V)

5.6 Parameter setting Hands Free



First ensure that the rubber seal on the microphone fits properly, otherwise setting the acoustic parameters will be difficult.

Parameter	Value	Meaning	Basic
71	gg	Reception volume 01-16 (16 is the highest) (SPK)	07
72	ff	Transmission volume 01-16 (16 is the highest) (MIC)	07
73	rr	Speaker volume 01-16 (16 is the highest) (TRH)	07

gg/ff/rr Each number is entered as 2 digits with a range 01-16. After receiving a confirmation tone 🎵 the new value is immediately active and can be tested.

Facilitation: you can also add/reduce the volume with help of buttons on the phone * = - and # = +

Stops for the maximum and minimum volume are acoustically signalled (3 tones like the signal for the end of a call). If you don't press anything for 5 seconds then the 'set value' is saved and you hear a confirmation tone 🎵.

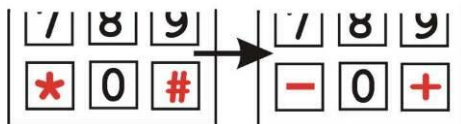

WARNING !! Default values are set by the manufacturer and it is not recommended that you change them unless absolutely necessary.

Parameter	Value	Meaning	Basic
74	c	Soft transition of switch over (0/1)	1

This function is set to **off** as standard **c=0**, it is a character of the semi-duplex operation switch over on the telephone line. If the character of silencing is too steep, it is possible to soften it using **c=1**.

Parameter	Value	Meaning	Basic
75	n	Suppression of background noise (0/1)	1

This function is set to **off** as standard **n=0**. If the Brave is installed in noisy location (train station, busy street, car park etc.) by switching on this circuit **n=1** the noise level is set as a default threshold for switching on the microphone and is not one way opened. This is related to setting of parameters 71, 76, 77.

Parameter	Value	Meaning	Basic
76	b	Threshold for switching on the microphone 1-4 (4 is the highest)	2

There is a simultaneous signal from the microphone and the speaker on the telephone line, to ensure that the Brave doesn't produce acoustic feedback. In the Hands Free circuit there are several functioning blocks for suppressing this feedback. The basic one is a circuit for semi-duplex operation, where the incoming signal weakens the microphone and the signal from the microphone weakens the incoming signal. Thresholds for switching on the microphone are set in this parameter, the lower the value the higher the sensitivity of the microphone. In noisy surroundings it is recommended to use a higher value with combination of parameters 71,75, 77.

Parameter	Value	Meaning	Basic
77	s	Speed of switching over voice atomisation 1-4 (4 is the slowest)	2

Parameters 75, 76 describes the principle of acoustic feedback and the speed with which the circuit switches over, the quality of incoming or outgoing sounds are set with parameter 77.

Switchover time [ms]	s - choice
1	1
2	2
4	3
8	4

Parameter	Value	Meaning	Basic
78	I	VA characteristic for line connection (0/1)	1

Nearly every country in the world has different telephone norms and this parameter enables you to lower the voltage on the Brave's terminals to connect telephone line voltages in active state by 1V. Where it is required the respective norm **I=0** lowers line voltage by 1V, as standard it is **I=1**.

Parameter	Value	Meaning	Basic
79	k	Compensation for loss of conduit depending on line current (0/1/2)	1

The Brave has a circuit for installations remote from the switchboard (>100m) that can compensate for the loss caused by a conduit. This function is switched **off** as standard **k=0**, but it is possible to set on 2 levels, depending on the current that switchboard can supply (short circuit current I_0).

Switchboard current I_0	k - choice
Function off	0
20mA-50mA	1
45mA-75mA	2

Parameter	Value	Meaning	Basic
70	uu	Level of signal transmission v [-dBm] (04-16)	10

uu The signal transmission range to the line is -4 to -16dBm, entered is required level, which is uu=04 is -4dBm, uu=10 is -10dBm ...

5.7 Basic setting and deletion

Parameter	Value	Meaning	Basic
8#	#	Basic setting	provide

This setting does not affect parameters 1 and 2 (numbers saved in memory)

Parameter	Value	Meaning	Basic
81		Deletes all numbers in 1st group (regime Day)	
82		Deletes all numbers in 2nd group (regime night)	
83		Basic setting only for parameters 3x	only 3..
84		Basic setting only for parameters 4x	only 4..
85		Basic setting only for parameters 5x	only 5..
86		Basic setting only for parameters 6x	only 6..
87		Basic setting only for parameters 7x	only 7..

Parameters 81 and 82 deletes all numbers saved in the button memory.

Parameters 83 – 87 deletes selective basic setting for parameters starting with 3,4,5,6,7. Values for the basic setting are stated for each parameter in the right hand - column "Basic".

 **WARNING !!!** deletion is irreversible and it would be necessary to reprogramme them again!

5.8 End of programming

Parameter	Value	Meaning	Basic
9		E N D of programming	

After choosing 9 programming tone the Brave disconnects.

5.9 Parameter overview

Parameter	Value	Meaning	Basic
1	tt nn...	number nn under button tt	-
2	tt nn...	number nn under button tt	-
31	r m	relay r works in regime m (1-6)	11 21
31	r* tt	button tt causes switching on of relay r in regime m=6 (01-04)	1*01
32	rp hh...	In regime DAY + NIGHT password hh... for relay r , in order p=1-5 , for 1 impulse and p=* for 2 impulses (11-444444)	-
33	rp hh...	In regime DAY password hh... for relay r , in order p=1-5 , for 1 impulse and p=* for 2 impulses (11-444444)	-
34	rp hh...	In regime NIGHT password hh... for relay r , in order p=1-5 , for 1 impulse and p=* for 2 impulses (11-444444)	-
35	r aa	command aa from the phone for switching on relay r 1 impulse (00-99,*0-*9)	155 266
36	r cc	command aa from the phone for switching on relay r 2 impulses (00-99,*0-*9)	150 260
37	r ss	time ss [sec] of relay r switch on for time t1 (01-99)	105 205
38	r p	Control of relay r during incoming call (0/1)	11 21
30	r zz	period zz [sec] between impulses for switching on 2 impulses of relay r – time length t2 (01-99)	105 205
3#0	p	p = 1 enabled / disabled p = 0 connection code relay COSW (0/1)	0
3#1	abcd	activation code 1 pulse from buttons (0000-1111)	0000
3#1	abcd	activation code 1 pulse from phone (0000-1111)	0000
3#1	abcd	activation code 2 pulses from buttons (0000-1111)	0000
3#1	abcd	activation code 2 pulses from phone (0000-1111)	0000
3#5	abcd	activation code from other modes of switch (0000-1111)	0000
41	v	Type of choice v – ton/impulse (0/1)	0
42	z	Sign for call prolonging (* / #)	*
43	g bb	Command for Brave disconnection from the phone (00-99,*0-*9)	155 266

44	xxxx	Service password (0000-9999)	0000
45	dd	Command for switch over to DAY (00-99,*0-*9)	11
46	nn	Command for switch over to NIGHT (0099,*0-*9)	10
47	e	Regime system choice (0/1)	1
4*	k	Line disconnection by repeat press of the same button (0/1)	1
51	q	Umber of rings before Brave picks up (1-9)	2
52	d	Maximum length of call (0-9,*,#)	2
53	w	Time between button presses (1-9)	2
54	z	Time of disconnection for repeat choice (1-5)	2
55	z	Time before choice begins (1-5)	1
56	hh	Number of rings before disconnection (04-99)	12
500	x	Medium frequency of tone detector (1-0)	3 (375-475Hz)
501	y	Number of busy tones (2-0)	4
502	z	Length of time for permanent tone (1-5)	3 (3s)
503	tt	Length of time for DTMF (tone) choice (04-16)	10 (100ms)
504	mm	Length of time for gap between DTMF tones (04-16)	10 (100ms)
505	f	Length of time Flash (1-6)	1 (100ms)
506	p	Length of time for pause/inter-digit gap (1-0)	4 (800ms)
507	uu	Level of transmission of DTMF choice v [-dBm] (04-16)	10
508	p	preemphasis DTMF (0/1)	0
509	S	Listening in DTMF – level (1-4)	2
61	z	Acoustic signalisation (confirmation, error, empty memory, end of call...) (0/1)	1
62	v	Acoustic signalisation Intro/Concl. (0/1)	1
63	u	Acoustic signalisation ticking into a call (0/1)	0
65	z	Acoustic signalisation for relay switch on (0/1)	0
66	i	Suppression of reception DTMF from microphone (0/1)	0

67	b	Baby Call – call without the need to programme in number (0/1)	0
68	b	Mute at the lock activated (0/1)	0
6#	s	Setting of number of buttons on the main panel	2
6*	t	Delayed start for switchboards with line tests (Siemens) (0/1)	0
71	gg	Reception volume 01-16 (16 is the highest) (SPK)	07
72	ff	Transmission volume 01-16 (16 is the highest) (MIC)	07
73	rr	Speaker volume 01-16 (16 is the highest) (TRH)	07
74	c	Soft transition of switchover (0/1)	1
75	n	Suppression of background noise (0/1)	1
76	b	Threshold for switching on the microphone 1-4 (4 is the highest)	2
77	s	Speed of switching over voice atomisation 1-4 (is the slowest)	2
78	l	VA characteristic for line connection (0/1)	1
79	k	Compensation for loss of conduit depending on line current (0/1/2)	1
70	uu	Level of signalisation transmission in [-dBm] (04-16)	10
8#	#	Basic setting	provide
81		Deletes all numbers in 1st group (regime Day)	
82		Deletes all numbers in 2nd group (regime night)	
83		Basic setting only for parameters 3x	only 3..
84		Basic setting only for parameters 4x	only 4..
85		Basic setting only for parameters 5x	only 5..
86		Basic setting only for parameters 6x	only 6..
87		Basic setting only for parameters 7x	only 7..
9		E N D	

6 Technical parameters

6.1 Electrical parameters

Parameter	Value	Conditions
Minimum line current	18mA	Line picked up
Minimum line voltage	18V	Line disconnected
Voltage on the line when Brave picks up (VA characteristic)	< 8V < 12V ¹⁾	I = 20mA I = 60 mA
Lead in in disconnected state	< 30uA	U = 60V
Impedance of line ending	220R + 820R paral. 115nF	Line picked up
Bandwidth	300Hz – 3400 Hz	20 - 60mA
Impedence of ringing	> 2Kohm	25 – 60 Hz
Sensitivity of ringing detector	min. 10 – 25 V	
Impulse choice	40 / 60 ms	
Level of tone choice	-6 a -8 dB ¹⁾	20 – 60 mA
Sensitivity of tone choice	min. -40 dB	20 – 60 mA
Sensitivity of tone detector	min. -30 dB	20 – 60 mA
Power supply for name tag back lighting, relay, heating and current circuit for exit button	12V DC(12V-24V) , 12V AC(10V-18V)	
Max off take of backlighting and heating	250mA	12Vss
Max. Voltage of relay contact	48V	When I < 1 A
Max. Current of relay contact	1,5A	When U < 30 V
Operating temperature	- 20 to + 60 st.	
Level of cover	IP44	

1) Potential to change by programming.

6.2 Mechanical dimensions

Dimensions WxHxD	104mm x 153mm x 16mm
Weight	360g
Unit material	elox aluminium profile
Name card panel material	acrylglas (plexiglass)

7 Table for easy programming

Fill in the values you want to programme into the empty part of the table, in the double framed part there are whole programming commands to make programming easier. You can keep the programmed values in the manual for future changes.

Meaning		Programming sequence		No of spaces
description	specify	par.	Fill the values	
Number under button 1	Day/1gr.	101		24
Number under button 2	Day/1gr.	102		24
Number under button 3	Day/1gr.	103		24
Number under button 4	Day/1gr.	104		24
Number under button 1	Night/2gr.	201		24
Number under button 2	Night/2gr.	202		24
Number under button 3	Night/2gr.	203		24
Number under button 4	Night/2gr.	204		24
Relay 1 works in mode	m=1 - 6	311		1
Passw. for relay 1 (1 imp.)	Day+Night	3211		6
Passw. for relay 1 (1 imp.)	Day+Night	3212		6
Passw. for relay 1 (1 imp.)	Day+Night	3213		6
Passw. for relay 1 (1 imp.)	Day+Night	3214		6
Passw. for relay 1 (1 imp.)	Day+Night	3215		6
Passw. for relay 1 (2 imp.)	Day+Night	321*		6
Passw. for relay 1 (1 imp.)	Day	3311		6
Passw. for relay 1 (1 imp.)	Day	3312		6
Passw. for relay 1 (1 imp.)	Day	3313		6
Passw. for relay 1 (1 imp.)	Day	3314		6
Passw. for relay 1 (1 imp.)	Day	3315		6
Passw. for relay 1 (2 imp.)	Day	331*		6
Passw. for relay 1 (1 imp.)	Night	3411		6
Passw. for relay 1 (1 imp.)	Night	3412		6
Passw. for relay 1 (1 imp.)	Night	3413		6
Passw. for relay 1 (1 imp.)	Night	3414		6
Passw. for relay 1 (1 imp.)	Night	3415		6
Passw. for relay 1 (2 imp.)	Night	341*		6

Button choice for 1 relay	m=6	311*		2
Switch on r 1 from phone	1 impulse	351		2
Switch on r 2 from phone <i>On keyboard - option</i>	1 impulse	352		2
Switch on r 1 from phone	2 impulses	361		2
Length of time for r 1 switch on	[sec]	371		2
Control of r 1 during incoming call	1 / 0	381		1
Control of r 2 during incoming call	1 / 0	382		1
Length of time between impulses of r 1	[sec]	301		2
Enable code relay (COSW-sw.1)	0/1	3#0		1
code for activation 1 imp./btn.	0000-1111	3#1		4
code for activation 1 imp./phn.	0000-1111	3#2		4
code for activation 2 imp./btn.	0000-1111	3#3		4
code for activation 2 imp./phn.	0000-1111	3#4		4
code for activation other mode	0000-1111	3#5		4
Type of choice tone / imp.	0 / 1	41		1
Sign for prolonging of call	* / #	42		1
Brave disconnection from phone	00-*9	431		2
Brave disconnection from phone	00-*9	432		2
Service password	0000-9999	44		4
Command for switch over to DAY	00-*9	45		2
Command for switch over to NIGHT	00-*9	46		2
Regime system choice	1 / 0	47		1
Disconnection by repeat press of the same button	0 / 1	4*		1
Number of rings for pick up	1-0	51		1
Maximum length of time	[min]	52		1
Time between button presses	[sec]	53		1
Time of disconnection for repeat choice	[sec]	54		1
Time before choice commences	[sec]	55		1
Number of rings before disconnection	04-99	56		2

Frequency of tone detector	table	500	ms	1
Number of busy tones	4-0	501		1
Length of time of permanent tone	1-5	502	sec	1
Length of time of tone choice	nn x 10	503	ms	2
Gap between DTMF tones	nn x 10	504	ms	2
Length of time Flash	n x 100	505	ms	1
Length of time of pause / gap	n x100+400	506	ms	1
Transmitting level DTMF	04-16	507	-dBm	2
preemphasis DTMF	0 / 1	508		1
Listening in DTMF - level	1-4	509		1
Acoustic signalisation (other)	0 / 1	61		1
Acoustic signalisation Intro/Concl.	0 / 1	62		1
Acoustic sign. ticking	0 / 1	63		1
Signal tone turning on relay	0 / 1	65		1
Suppression of reception from microphone	0 / 1	66		1
Baby Call	0 / 1	67		1
Mute at the lock activated	0 / 1	68		1
no of buttons on the panel	Type dependant	6#		1
Delayed start (Siemens)	0 / 1	6*		1
Reception volume (TRH)	01-16	71		2
Transmitting volume (MIC)	01-16	72		2
Speaker volume (SPK)	01-16	73		2
Soft transition of switch over	0 / 1	74		1
Suppression of background noise	0 / 1	75		1
microphone switch on threshold	1 - 4	76		1
Speed of switching over voice atomization	1 - 4	77		1
VA characteristic	0 / 1	78		1
Compensation for loss of conduit	0 / 1 / 2	79		1
Level of signalisation trans.	04 - 16	70	-dBm	2

WARRANTY:

Each and every product has been tested before it leaves the factory. The manufacturer guarantees that the product and its features will work in accordance with the descriptions in this manual as long as the customer uses the product in accordance with the manufacturer’s instructions.

Warranties will be extended when a warranty repair has been undertaken. Although all warranty repairs will be handled by the manufacturer it is important that warranty claims are handled through your dealer. Warranty claims should be accompanied by:

- The product in question;
- A description of the problem;
- Proof of purchase; and
- Your full name and address.

The warranty does not cover:

- Mechanical, chemical, thermal or any other faults cause by the user
- Faults caused by natural disasters
- Faults caused by repairs or changes made by the user or any other authorised or unauthorised person(s)
- Purposely done damage
- Incorrect use of the product, caused by incorrect installation, programming etc., and
- Damages cause during the transport of the product to and from the purchaser.

Manufacturer:
Dealer:
Date of sale:

8 Drilling master board

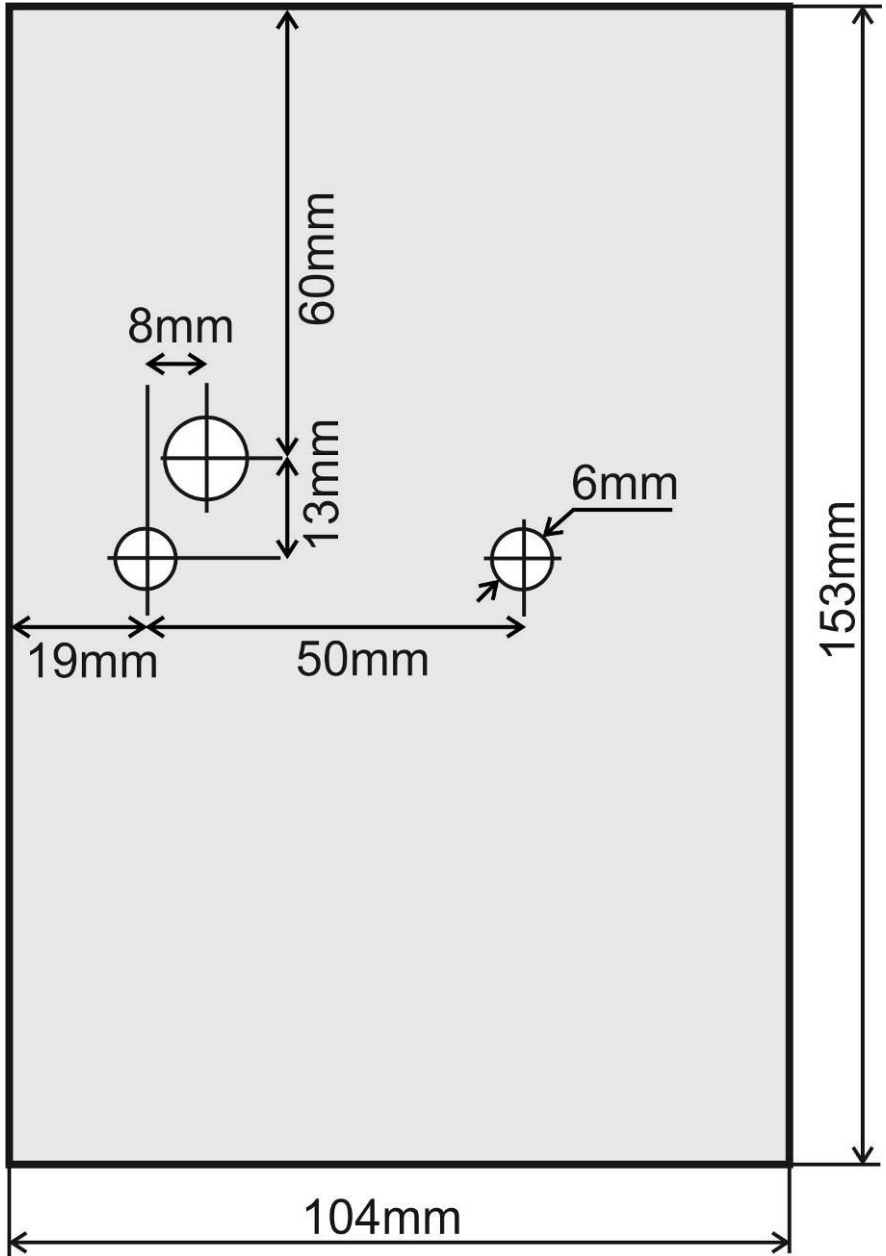

ALPHA

Tech