



Spectralink IP-DECT Server 6500

Installation and Configuration Guide

14215700 Version 6.0
October, 2015

Copyright Notice

© 2013 Spectralink Corporation All rights reserved. Spectralink™, the Spectralink logo and the names and marks associated with Spectralink's products are trademarks and/or service marks of Spectralink Corporation and are common law marks in the United States and various other countries. All other trademarks are property of their respective owners. No portion hereof may be reproduced or transmitted in any form or by any means, for any purpose other than the recipient's personal use, without the express written permission of Spectralink.

All rights reserved under the International and pan-American Copyright Conventions. No part of this manual, or the software described herein, may be reproduced or transmitted in any form or by any means, or translated into another language or format, in whole or in part, without the express written permission of Spectralink Corporation.

Do not remove (or allow any third party to remove) any product identification, copyright or other notices.

Notice

Spectralink Corporation has prepared this document for use by Spectralink personnel and customers. The drawings and specifications contained herein are the property of Spectralink and shall be neither reproduced in whole or in part without the prior written approval of Spectralink, nor be implied to grant any license to make, use, or sell equipment manufactured in accordance herewith.

Spectralink reserves the right to make changes in specifications and other information contained in this document without prior notice, and the reader should in all cases consult Spectralink to determine whether any such changes have been made.

NO REPRESENTATION OR OTHER AFFIRMATION OF FACT CONTAINED IN THIS DOCUMENT INCLUDING BUT NOT LIMITED TO STATEMENTS REGARDING CAPACITY, RESPONSE-TIME PERFORMANCE, SUITABILITY FOR USE, OR PERFORMANCE OF PRODUCTS DESCRIBED HEREIN SHALL BE DEEMED TO BE A WARRANTY BY SPECTRALINK FOR ANY PURPOSE, OR GIVE RISE TO ANY LIABILITY OF SPECTRALINK WHATSOEVER.

Spectralink Corporation,
2550 55th Street,
Boulder CO 80301,
USA

Spectralink Europe ApS,
Langmarksvej 34,
8700 Horsens,
Denmark

Contents

Preface

Important Information Before You Begin	4
Related Documentation	5
Acronyms	6

Introduction to Spectralink IP-DECT Server 6500

Solution Components	9
Requirements for the Spectralink IP-DECT Server 6500 Solution	11
Installation Prerequisites	13

Installing Spectralink IP-DECT Server 6500 and Spectralink Media Resource

Description	15
Installation	18

Installing Spectralink Base Station

Spectralink IP-DECT Base Station Description	23
Installing the Spectralink Base Station	26
Recording the Installation Information	28

Installing Spectralink Repeater

Spectralink Repeater Description	29
Installing the Spectralink Repeater	31
Recording the Installation Information	33
Checking Indicators	33
Powering the Spectralink Repeater	34
Programming with the Spectralink Programming Kit	34
Use of Spectralink Repeater With External Antenna	37

Basic Network Configuration

Recommended Network Configuration	38
Assigning DHCP Server Options	39
Assigning DHCP Server Reservations	39

Configuring the IP-DECT Server 6500

Discovering the Spectralink IP-DECT Server 6500 via UPnP	40
Accessing the Web Based Administration Page	40
Configuring a Spectralink IP-DECT Server 6500 Using Static IP Address	43
Checking Indicators	51
Deployment of a Multi-Cell Solution	51

Configuring Spectralink Media Resources

Configuring a Spectralink Media Resource Using Static IP Address	58
Checking Indicators	59

Configuring Spectralink IP-DECT Base Station

Powering up the Spectralink Base Station	60
Accessing the Web Based Administration page of the Base Station	60
Accessing the Web Based Administration Page	61
Configuring a Spectralink Base Station	63
Checking Indicators	68

Spectralink Handset Registration

Registering Spectralink Handsets	69
--	----

Spectralink Handset Management

Viewing Handset/User Configuration	72
Searching for Handset/User Information	72
Unsubscribing Spectralink Handsets	73
Removing Spectralink Handsets from the List (Deregistering)	74
Changing User Configurations	76
Exporting Handset Registration Data	77

Restoring Handset Registration Data	78
Importing Handset Registration Data - CSV Format	79

System Management

Spectralink IP-DECT Server 6500	82
Spectralink Media Resources	93
Spectralink IP-DECT Base Station	98

Messaging over MSF

Description of Different Types of MSF Messages	105
Sending Text Messages	106

Regulatory Notices

International Regulatory and Product Information	107
Safety	111
Important Safety Instructions and Product Information	111

Open Source Software Notice.

Open Source Software Notice	115
-----------------------------------	-----

Repeater Numbering

Overview of Ports and Protocols

Figures 110

Chapter 1: Preface

This guide is intended for qualified technicians who will install, configure and maintain the Spectralink IP-DECT Server 6500 Solution. To qualify to install the Spectralink IP-DECT Server 6500 Solution, you must have successfully completed the Spectralink IP-DECT Server 6500 technical training. The guide provides all the necessary information for successful installation and maintenance of the wireless solutions.

This includes the installation and configuration of:

- Spectralink IP-DECT Server 6500
- Spectralink Media Resource
- Spectralink IP-DECT Base Station
- Spectralink DECT Repeater

The Installation Guide also provides you with information about:

- Web based Administration Page of the Spectralink IP-DECT Server 6500, media resource and base station

Important Information Before You Begin

This guide assumes the following:

- that users have a working knowledge of the call handler's operations
- that the call handler is installed and initialized and is working correctly
- that you have a working knowledge of deployment in general
- that a site survey has been conducted and that the installer has access to these plans



Note

The site survey should determine the number of handsets, base stations and repeaters are needed and where to place them. The site survey should also determine how many RF channels are needed.

Related Documentation

For information about the Spectralink IP-DECT Server 6500 not covered by this manual, refer to the following documentation:

Table 1 Related Documentation

Subject	Documentation
Handset Operation	Handset User's Guide
Release Notes	Every software release is accompanied by a release note. The release note describes software changes, bug fixes, outstanding issues, and hardware compatibility considerations for the new software release. Read the release note before you begin a software upgrade! To obtain the release note, see www.Spectralink.com

Acronyms

AC	Authentication Code
ARI no.	Access Rights Identity - Serial number of the Spectralink IP-DECT Server 6500
CLI	Command Line Interface
dB	Decibels (deciBells)
DECT	Digital Enhanced Cordless Telecommunications
DHCP	Dynamic Host Configuration Protocol
DNS	Domain Name System
e.i.r.p.	Equivalent Isotropic Radiated Power
GAP	Generic Access Profile
HW PCS	Hardware Product Change Status - Hardware edition
IP	Internet Protocol
IPEI	International Portable Equipment Identity - Serial number of the handset - SN
IWU	Inter Working Unit
Spectralink IP-DECT Server 6500	Spectralink IP-DECT Server 6500
LAN	Local Area Network
LED	Light Emitting Diode
MAC	Media Access Control - hardware address of a device connected to a network
MTU	Maximum Translation Unit
MWI	Message Weighing Indication
NIC	Network Interface Card
NTP	Network Time Protocol
PBX	Private Branch eXchange
PCS	Product Change Status (Edition)
PoE	Power over Ethernet
PP	Portable Parts - wireless handset
RSSI	Received Signal Strength Indicator
RTP	Real-time Transport Protocol
SIP	Session Initiated Protocol
SW PCS	Software Product Change Status - Software edition
TFTP	Trivial File Transfer Protocol
UDP	User Datagram Protocol

VoIP	Voice over Internet Protocol
WLAN	Wireless Local Area Network
WRFP	Wireless Radio Fixed Part - Wireless Repeater

Chapter 2: Introduction to Spectralink IP-DECT Server 6500

A typical Spectralink IP-DECT Server 6500 configuration includes a number of the following components, in addition to the Spectralink IP-DECT Server 6500:

- Media resources
- Base stations
- Repeaters

Figure 1 Overview of the Whole Solution

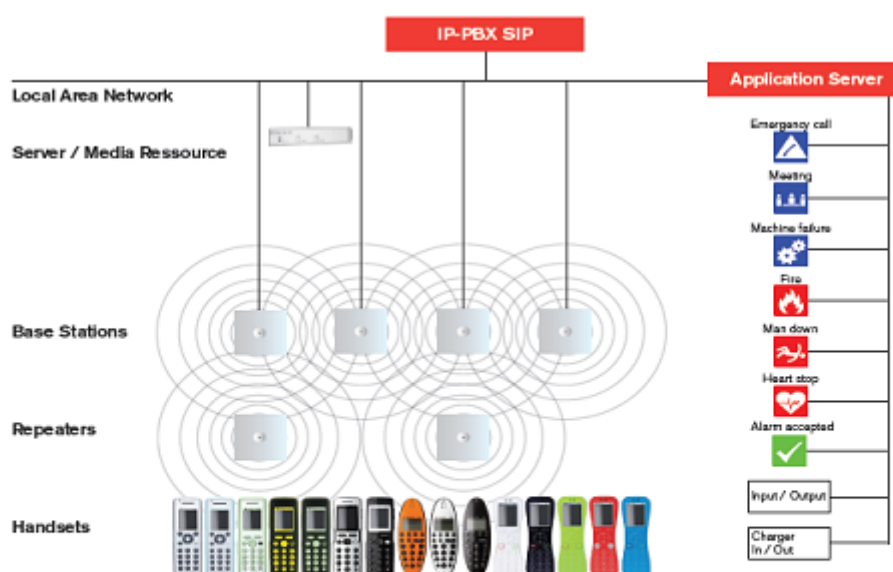

The IP-PBX SIP is also known as the call handler. Throughout this document the term call handler is used.

Solution Components

Spectralink IP-DECT Server 6500

The following is an overview of the system capacity of the Spectralink IP-DECT Server 6500

Table 2 Overview of System Capacity

Description	Capacity
Max. number of base stations. A minimum of 1 base station is required, as the Spectralink IP-DECT Server 6500 does not have a built-in radio.	512
Max. number of simultaneous calls on each base station	11
Max. number of repeaters on each base station	3
Max. number of simultaneous calls media resource (G.711, G.726)	32
Max. number of simultaneous calls per media resource (G.729)	12
Max. number of media resources	32*
Max. number of simultaneous calls with 32 media resources	1024
Max. number of registered handsets	4096

The Spectralink IP-DECT Server 6500 controls the wireless infrastructure. It manages media resources, base stations, repeaters and the IP interface to the call handler.

The communication protocol between the Spectralink IP-DECT Server 6500 and the call handler is a SIP line interface.

A Spectralink IP-DECT Server 6500 is installed directly on the LAN and must be managed as part of the corporate network.

Wireless Bands

The wireless solution supports two wireless bands, allowing operation in various countries and regions. Supported wireless bands are:

- ETSI DECT (1880-1900 MHz), referred to as DECT
- USA DECT (1920-1930 MHz), referred to as 1G9 or DECT 6.0
- SAM DECT (1910-1930Mhz), referred to as DECT IG9

The wireless band used by a Spectralink IP-DECT Server 6500 solution is determined by the base stations and handsets ordered with the solution.

Spectralink Media Resource

The media resource is a print board that is placed within the same rack next to the Spectralink IP-DECT Server 6500 board. Up to 2 media resources can be placed in the same rack that houses the Spectralink IP-DECT Server 6500 board.

The media resource performs media conversion between the call handler and the Spectralink IP-DECT Server 6500 and is the media termination point for incoming and outgoing calls.

Each Spectralink IP-DECT Server 6500 contains one built in media resource. The Spectralink IP-DECT Server 6500 can support a total of 32 media resources. Each media resource adds 32 voice channels. The maximum number of simultaneous calls for a fully loaded system is 1024 calls at the same time. If secure RTP is enabled, however, the number of voice channels supported by each media resource decreases to 24.

Spectralink Base Station

The base stations are positioned in the area to create coverage for DECT handset's ability to make and receive calls and messages. The base station contains internal antennas and has 12 channels. One channel is used for synchronization and 11 channels can be used simultaneously as speech channels. A base station is able to synchronize with other base stations. When the base station is synchronized with other base stations, a person speaking in a handset can move between base stations without any interference. This is known as seamless handover.

LAN transmission length is up to 100 meters/329 feet according to IEEE 802.3u on a twisted pair cable, minimum cat.5e. The base station can be powered by a power supply or by PoE. The base station is a class 1 PoE device (802.3af) and must be powered accordingly (maximum power supply consumption 3.0W according to PoE 802.3af). The radius coverage of the base station is up to 90 meters/295 feet indoor and up to 300 meters/984 feet outdoor, with a handset in line-of-sight.

Coverage area decreases depending on choice of building materials and obstructive elements. To ensure proper coverage in the areas required, it is necessary to conduct a site survey and deployment by certified technicians. For more information about deployment, refer to the online Deployment Guide.

Spectralink Repeater

The repeater can be used to extend the coverage area in a wireless solution. The wireless repeater is used in areas with limited voice traffic, where cabling is difficult. The repeater does not increase the number of traffic channels, but increases the coverage area established with the base station. Up to three repeaters can be placed in cascade formation directing coverage in a certain direction.

The base station can support up to 3 repeaters.

Spectralink Handset

The handset is a portable unit compatible with DECT GAP standard.

The handset is designed to provide the subscriber with most of the features available for a wired phone, in addition to its roaming and handover capabilities.

The Spectralink IP-DECT Server 6500 supports up to 4096 registered handsets.

Auto Login and Handover

Auto login refers to the ability to log on to more than one system, enabling you to use the same handset on up to 15 different systems. If a handset is subscribed to two or more systems, you can use Auto Login.

- Auto Login is used if a handset is subscribed to two or more systems.

Handover refers to the ability to move between the coverage areas of different radio units on the same system while talking, without interruptions in the conversation.

Requirements for the Spectralink IP-DECT Server 6500 Solution

This section provides information about the environmental and electrical requirements and software requirements for the Spectralink IP-DECT Server 6500 solution.

Spectralink IP-DECT Server 6500/Spectralink Media Resources

Environmental Requirements

The installation area must:

- be clean, free of traffic and excess dust, dry, and well ventilated
- be within the temperature ranges of 10°C and 40°C/50°F and 104°F
- be between 20% and 80% non-condensing relative humidity



Note

The installation area must be of sufficient height from the floor to prevent water damage. 1U rack space in a 19" cabinet or respective space on the wall when mounting the IP-DECT Server 6500 in vertical position on a wall.

Spectralink Base Stations and Spectralink Repeaters

Environmental Requirements

- Avoid installing base stations and repeaters on large concrete or marble columns because these columns affect radio coverage. If possible, place the base station a minimum of one meter/3.3 feet from these types of columns.
- Do not install a base station or repeater with the antenna housings near metal objects. Be careful not to damage existing wiring or panels.
- Do not position base stations and repeaters in ducts, plenums, or hollow spaces used to transport environmental air except where the duct, plenum or hollow space is created by a suspended ceiling having lay-in panels. When you need more than one base station in a cell to meet traffic requirements, position the base stations at the same cell center.
- Keep the base station and repeater away from steel constructions.
- Do not position base stations and repeaters directly on metallic surfaces. If possible, place the base station a minimum of one meter/3.3 feet from these types of surfaces.
- Do not position base station and repeaters behind furniture.
- Only position base stations and repeaters where the signal is needed.
- The installation area must be clean, free of traffic and excess dust, dry, and well ventilated.
- The installation area must be within the temperature ranges of 10°C and 40°C/50°F and 104°F.
- The installation area must be between 20% and 80% non-condensing relative humidity.
- Minimum distance between two base stations varies depending on material and construction of buildings, but there must always be synchronization chains and radio coverage overlap between the two base stations or handover between radio units. The time it takes a person to cross the common coverage area must be 10 seconds or more, as the handset needs time to scan for an alternative base station.

Electrical Requirements for Base Station

The following electrical requirements must be met:

- The base station operates on standard twisted pair ethernet cable - e.g. minimum Cat.5e - to prevent disturbances from other equipment.
- Maximum power supply consumption is 3.0W (IEEE 802.3af class 1 device).
- The max. radiated output power for the antenna is 10mW e.i.r.p/channel.
- The supplied power (power supply) for the charger must be 110 V to 120 V
- V ac nominal (or 220 V to 230 V ac nominal), 50/60 Hz.

Electrical Requirements for Repeater

- The supplied power (power supply) for the charger must be 110 V to 120 V ac nominal (or 220 V to 230 V ac nominal), 50/60 Hz.

Spectralink Handsets

Environmental Requirements

- The area where the handset is used must be within the temperature ranges of 0°C and 40°C/32°F and 104°F.
- For correct battery charging, the room temperature must be between 0°C and 40°C/0°F and 104°F. Therefore, the handset must not be placed in direct sunlight. The battery has a built-in heat sensor which will stop charging if the battery temperature is too high.
- For battery information, refer to the handset user guide.
- The area where the handset is used must be between 20% and 80% non-condensing relative humidity.

Electrical Requirements

The following electrical requirement must be met:

- The supplied power (power supply) for the charger must be 110 V to 120 V ac nominal (or 220 V to 230 V ac nominal), 50/60 Hz.

Spectralink Maintenance Software

Software Requirements

The following is required to run the handset and repeater installation and maintenance tools.

- OS: Windows XP or newer

Installation Prerequisites



Note

Ensure that a site survey and deployment have been conducted and that the installer has access to these plans before proceeding any further.

Before you start the installation you need to find the following information and perform the following tasks:

- ARI codes (serial numbers) for the Spectralink IP-DECT Server 6500 (see label on the rear of the KWS unit)
- Serial numbers for handsets.
- AC codes (authentication codes)

The AC is a customer-defined optional subscription pin code of a maximum of eight digits for the individual handset. The AC can be used when connecting the handset to the Server.

- Repeaters:

Mark each repeater with the number of the related base station. This way you can easily configure the system on site.

- Handsets:

To use the handsets, you must first install the radio infrastructure, e.g. base stations and repeaters to transmit and receive radio signals to and from the handsets. There are no direct connections between the handset and the system.

- Charging battery

When charging the handset battery for the first time, leave the handset in the charger for 14 - 16 hours to ensure that the battery is fully charged and the handset ready for use. Refer to the handset user guide for more information.

Chapter 3: Installing Spectralink IP-DECT Server 6500 and Spectralink Media Resource

This section provides a description of the Spectralink IP-DECT Server 6500 and media resource. The section also provides information about resetting the Spectralink IP-DECT Server 6500 hardware using the Reset button on the Spectralink IP-DECT Server 6500/media resource print board.



Note

The installation of a media resource is optional. Installation of a media resource will augment the number of simultaneous voice calls supported by a stand-alone server. The Spectralink IP-DECT Server 6500 comes with one build-in media resource.

Before you install the equipment, ensure that a site planner defines the locations of the Spectralink IP-DECT Server 6500 and media resources.

Description

Types and Part Numbers

The following table includes a list of available Spectralink IP-DECT Server 6500 and their part numbers.

Table 3 Spectralink IP-DECT Server 6500 Part Numbers

Variants of Spectralink IP-DECT Server 6500	Part Number
Spectralink IP-DECT Server 6500 Rack (two empty slots)	02350000

Spectralink Media Resource Types and Part Numbers

The following table includes a list of available media resources and their part numbers.

Table 4 Spectralink Media Resource Part Numbers

Variants of Spectralink Media Resources	Part Number
Spectralink Media Resource	02344400
Spectralink Media Resource mounted in 19" in Rack	02351000

Spectralink IP-DECT Server 6500/Spectralink Media Resource Appearance and Components

Figure 2 Add-on media resource for empty slot in a Server 6500 Rack



The Spectralink IP-DECT Server 6500/media resource front includes the following (see figure below).

Figure 3 Spectralink IP-DECT Server 6500/Media Resource - Front



Spectralink IP-DECT Server 6500/Spectralink Media Resource LED Indicators

Front Faceplate

The Spectralink IP-DECT Server 6500/media resource front cover has one indicator describing the faults and failures of the device. The indicator is off when the Spectralink IP-DECT Server 6500/media resource is not powered. The LED flashes when the Spectralink IP-DECT Server 6500/media resource initializes. The indicator is on when the Spectralink IP-DECT Server 6500/media resource is operating.

Table 5 LED Indicator Description - Front Faceplate

LED Indicator	Meaning
Steady green	OK and idle
Slow green flashing	OK and active voice call
Fast green flashing	Active, in operation with the maximum active connections (busy)
Slow red flashing	Missing media resource or base station (if it is a media resource: missing connection to Spectralink IP-DECT Server 6500)
Fast red flashing	Error
Steady red	Reset/shutdown in progress
Steady red for 5 seconds followed by fast red flashing	Reset to factory settings

Front Lan Port

Table 6 LED Indicator Description - Front Lan port

LED Indicator	Meaning
LINK Indicator - yellow	Link layer software has established connection
Activity Indicator - green flashing	Activity

Spectralink IP-DECT Server 6500/Spectralink Media Resource - Reset Button

It is possible to restart or reset the Spectralink IP-DECT Server 6500/media resource by pressing the Reset button on the front of the Spectralink IP-DECT Server 6500/media resource.

Resetting the Spectralink IP-DECT Server 6500/Spectralink Media Resource Hardware

The following table contains a description of the different actions that take place when you press the Reset button.

Table 7 Reset Button Description

Press button	Action
Short press (2 to 5 sec.)	System restarts when button is released.
Long press (5 to 9 sec.) until front LED flashes red, then release button	Resets the system to factory default settings (original IP settings and empty user data base) and restarts the system. Firmware version is not affected.

Installation

The Spectralink IP-DECT Server 6500/media resource is mountable in a rack.

Figure 4 Spectralink IP-DECT Server 6500/Media Rack Mounting



- 1 Mount the two wings with the screws. If you are mounting the Spectralink IP-DECT Server 6500 on a wall, twist the wings 90° degrees.
- 2 Mount the cabinet in the 19" rack or on the wall, Screws and nuts/rawl plugs are not supplied.
- 3 Connect the RJ45 ethernet plug to the front of the cabinet. All servers and media resources must be connected to a switch port. Installed Media Resources must have their own switch port.
- 4 Connect the power on the back of the cabinet.

The following images illustrate how to install the media resource.

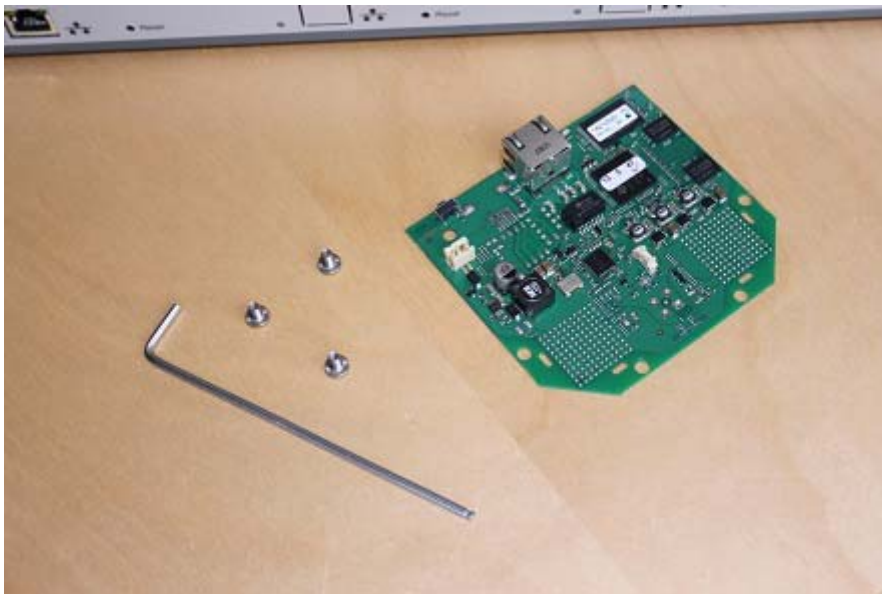
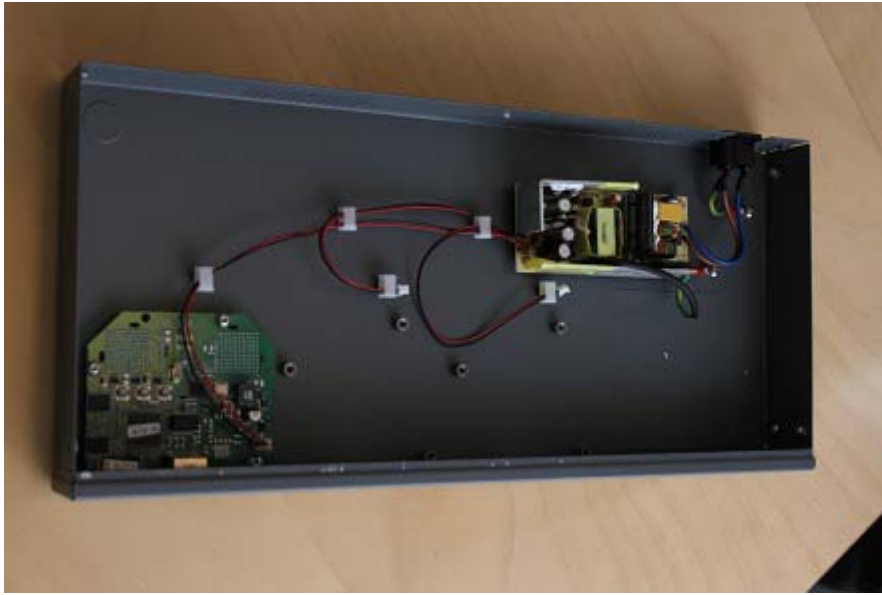



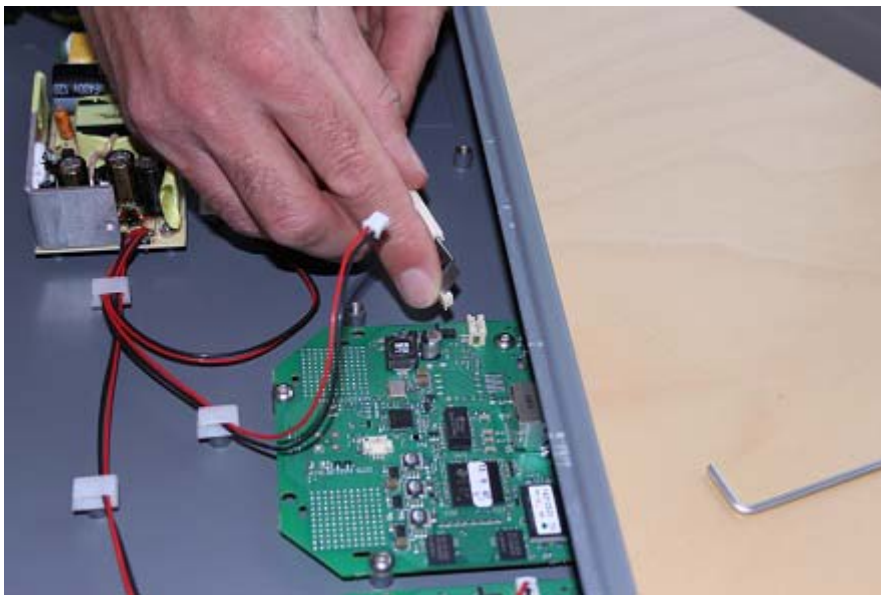

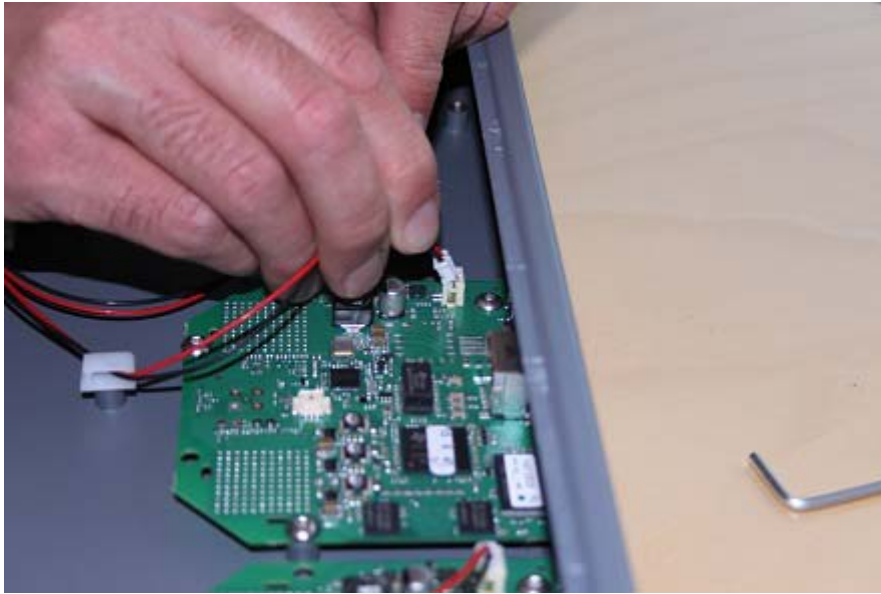

Chapter 4: Installing Spectralink Base Station

This section provides information about the base station and how to install it.

Before you install the equipment, ensure that a site planner defines the location of the base stations.

Spectralink IP-DECT Base Station Description

Spectralink Base Station Provides DECT Coverage to Spectralink Handsets

The base station is a compact device that contains RF circuitry and transmit/receive antennas. The main function of the base station is to provide audio and data communication between the handsets and the Spectralink IP-DECT Server 6500. The base station supports 11 RF channels for speech channels.



Note

The base station is also termed by some manufacturers as the RFP (Radio Fixed Part)

DECT coverage is provided according to the band standard at the site:

- Base station - DECT provides 11 RF channels of 1.8 GHz, DECT standard, used in Europe, Australia and South America.
- Base station - USA DECT provides 11 RF channels of the 1.9 GHz, USA DECT standard, used in North America.

Spectralink Base Station Types and Part Numbers

The base station contain RF circuitry that comply with the local band standards: UPCS, DECT, or ETSI DECT. The following table includes a list of available base stations and their part numbers.

Table 8 Spectralink Base Station Part Numbers

Variants of Spectralink Base Stations	Part Number
Spectralink IP-DECT Base Station, 1G8 version (conforms with standard DECT markets)	02337400
Spectralink IP-DECT Base Station, 1G9 version (for North America)	02337401

Spectralink Base Station Appearance and Components

The base station front cover includes the following:

- LED that indicates the operating status of the unit

Figure 5 Base Station - Front view



The base station front includes the following (see figure below).

Figure 6 Base Station - Front

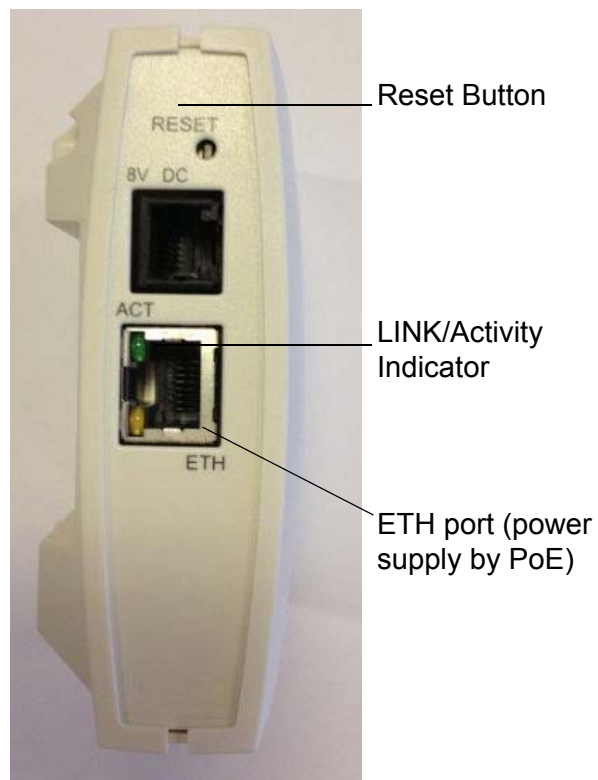

Spectralink Base Station LED Indicators

Front Cover

The base station front cover has one indicator describing the base station faults and failures. The indicator is off when the base station is not powered. The LED flashes when the base station initializes. The indicator is on when the base station is operating.

Table 9 LED Indicator Description - Front Cover

LED Indicator	Meaning
Steady green	OK and idle
Slow green flashing	OK and active voice call
Fast green flashing	No sync over air possible, or sync master is not available.
Slow red flashing	Missing media resource or base station (if it is a media resource: missing connection to Spectralink IP-DECT Server 6500)
Fast red flashing	Error
Steady red	Reset/shutdown in progress
Steady red for 5 seconds followed by fast red flashing	Reset to factory settings

LAN Port on Face Plate

Figure 7 LED Indicator Description - LAN port
Table 4-1

LED Indicator	Meaning
LINK Indicator - yellow	Link layer software has established connection
LINK Indicator - green flashing	Activity

Spectralink Base Station - Reset Button

It is possible to restart or reset the base station by pressing the Reset button on the bottom of face plate of the base station.

Resetting the Spectralink Base Station Hardware

The following table contains a description of the different actions that take place when pressing the Reset button.

Table 5 Reset Button Description

Press button	Action
Short press (2 to 5 sec.)	System restarts when button is released.
Long press (5 to 9 sec.) until front LED flashes red, then release button	Resets the system to factory default settings (original IP settings (DHCP) and empty user data base) and restarts the system. Firmware version is not affected.

Installing the Spectralink Base Station

The base station is suitable for mounting indoors on a wall.

The base stations are designed to only be mounted on the wall at least 2,40 m (8ft) off the ground but no higher than 6 m (20ft). The connectors can be pointed either up or down. The base stations should not be flush mounted to the ceiling as it would affect signal propagation. If ceiling mounting is a requirement, the base stations could be drop mounted from the ceiling in the same orientation (i.e., vertical) and height (no higher than 6 m (20ft) from ground as described for wall mounting. If mounting base stations higher than 6 m (20ft) off the ground, coverage directly underneath the base station will be impacted.



Note

Before you begin the installation, determine the position of the base station for best coverage. The coverage depends on the construction of the building, architecture, and the choice of building materials.

Wall Mounted (Vertical) Installation RF Coverage

For best RF coverage, the base station must be mounted vertically on walls. The antennas must always be kept perpendicular to the floor.



Caution

The base station must not be installed at any angle other than vertical.



Caution

Do not mount the base station on soft surfaced walls such as those covered with canvas, metal or sponge-like materials



Caution

Do not mount the base station on soft surfaced walls such as those covered with canvas, metal or sponge-like materials

- 1 Mount the base station on the wall using the anchors and screws accompanying the product.



Note

When you place the base station on the screws, ensure that the screws do not touch the printed circuit board.

Figure 8 Base Station Wall Mounting



- 1 Connect the RJ45 plug to the ethernet connector at the bottom of the base station.

Figure 9 Base Station - Ethernet Connector



Recording the Installation Information

After completing the installation of the base stations, record the location of each base station and add a descriptive text in the Administration Page of the Spectralink IP-DECT Server 6500 under **Administration/Base stations**.

Chapter 5: Installing Spectralink Repeater

This section provides information about the repeater and how to unpack and install it. Installing repeaters requires a software installation as well as a hardware installation.

Before you install the equipment, ensure that a site planner defines the location of the repeaters.

For outdoor installations, the following items should be present in every box containing a Spectralink Repeater:

- Spectralink Repeater
- Two mounting screws and anchors



Caution

For outdoor installations you need to mount the Spectralink Repeater in spots to prevent influence from weather conditions.

Spectralink Repeater Description

Spectralink Repeater Provides DECT Coverage to Spectralink Handsets

The Spectralink Repeater is a building block to be used to extend the coverage area in a Spectralink solution. The repeater does not increase the number of traffic channels, however it provides a larger physical spreading of the traffic channels and thereby increases the coverage area established with the Spectralink Base Stations. The repeaters are mainly used in areas with limited traffic.

The Spectralink Repeater is available with either 2 or 4 voice channels. It is wireless and does not need physical connection to the Spectralink Wireless Server, which makes it easy to install. The repeaters can be supplied with an external antenna making it possible to create radio coverage in a remote area without cabling to the rest of the installation.



Note

The repeater is also termed by some manufacturers as the WRFP (Wireless Radio Fixed Part).

The RF communication is provided according to the band standard at the site:

- Repeater - DECT provides four RF channels of 1.8 GHz, DECT standard, used in Europe, Australia and South America.
- Repeater - USA DECT provides four RF channels of 1.9 GHz, USA DECT standard, used in North America.

Spectralink Repeater Types and Part Numbers

The repeater contains RF circuitry that comply with the local band standards: UPCS, DECT, or ETSI DECT. The wall mounted repeater and the ceiling mounted repeater is available as a full slot repeater. A full slot repeater covers four simultaneous speech channels. These channels are borrowed from the attached base station, and are not additional channels to the total number of channels on the system. The Spectralink Repeater can be installed either indoors or outdoors.

- Indoors. The Spectralink Repeater is suitable for mounting indoors on a wall or ceiling.
- Outdoors. The Spectralink Repeater can be placed in a weatherproof, environmentally protected unit suitable for installation on external walls, poles etc.

The following table includes a list of available repeaters and their part numbers.

Table 6 Repeater and Part Numbers

Variants of Spectralink Repeaters	Part Number
Spectralink Repeater Multi Cell 1.8 GHz w/external antenna, 2 Channel	0244 0000
Spectralink Repeater Multi Cell 1.9 GHz w/external antenna, 2 Channel	0244 1000
Spectralink Repeater Multi Cell 1.8 GHz w/external antenna, 2 Channel	0244 1600
Spectralink Repeater Multi Cell 1.9 GHz w/external antenna, 2 Channel	0244 0200
Spectralink Repeater Multi Cell 1.8 GHz w/o external antenna, 2 Channel	0244 1100
Spectralink Repeater Multi Cell 1.9 GHz w/o external antenna, 2 Channel	0244 1200
Spectralink Repeater Multi Cell 1.8 GHz w/0 external antenna, 2 Channel	0244 4601
Spectralink Repeater Multi Cell 1.9 GHz w/0 external antenna, 2 Channel	0244 8200

Spectralink Repeater - Appearance and Components

The repeater connection panel includes the following:

- Power supply connection (connection for programming the repeater as well). The power supply for the repeater must be ordered separately (Part no. 84642602).
- Antenna connector for repeaters supplied with external antenna connection. The external antenna including the antenna cable must be ordered separately (part no. 02319507).
- LED that indicates whether or not the unit is functioning.

Figure 10 Repeater

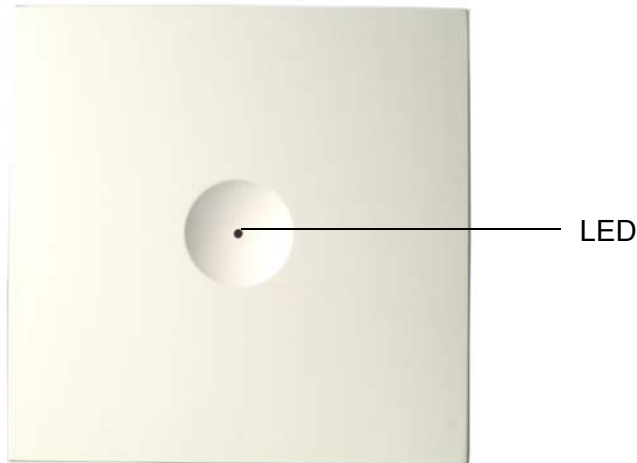

Spectralink Repeater LED Indicators

The repeater has one LED indicator describing the repeater operations: The indicator is off when the repeater is not powered. When the LED flashes after the repeater has been powered, sync has still not been established. As soon as sync has been established the LED is on. Each time a handset connects to the repeater, the LED flashes shortly. Each time a handset makes handover to a repeater, the LED flashes shortly.

Installing the Spectralink Repeater

Before beginning the installation, determine the position of the repeater for best coverage. The coverage depends on the construction of the building, architecture, and the choice of building materials.

Environmental requirements

- Avoid installing repeaters on large concrete or marble columns because these columns affect radio coverage. If possible, place the base station a minimum of one meter/3.3 feet from these types of columns.
- Do not install a repeater with the antenna housings near metal objects. Be careful not to damage existing wiring or panels.
- Do not position repeaters in ducts, plenums or hollow spaces used to transport environmental air except where the duct, plenum or hollow space is created by a suspended ceiling having lay-in panels.
- Keep the repeater away from steel constructions.
- Do not position repeaters directly on metallic surfaces. If possible, place the base station a minimum of one meter/3.3 feet from these types of surfaces.
- Do not position repeaters behind furniture.
- Only position repeaters where the signal is needed.
- The installation area must be clean, free of traffic and excess dust, dry, and well ventilated.
- The installation area must be within the temperature ranges of 10°C and 40°C/50°F and 104°F.
- The installation area must be between 20% and 80% non-condensing relative humidity.



Note

The repeater does not add channels, it only adds additional coverage area.



Note

The repeater can be registered on the system 1) when placed within the coverage area of a base station 2) when placed within the coverage area of an already-installed repeater or 3) when placed outside the coverage area using an external antenna.

For best RF coverage, the repeater must be mounted vertically on walls. The antennas must always be kept perpendicular to the floor.



Caution

The repeater must not be installed at any angle other than vertical. If the repeater is placed upside-down, the coverage area of the repeater is decreased by 40 - 50% and it might not transmit or receive effectively.

Figure 11 Connect Power to the Bottom of the Repeater and External Antenna Cable to the Rear of the Repeater



- 1 Connect the power supply cable into the RJ9 (4P4C) connector in the bottom of the repeater. For repeaters with external antenna, connect the external antenna cable to the antenna connector in the rear of the repeater as well.
- 2 Mount the repeater onto the wall using the screws accompanying the repeater.



Note

The external antenna used for the transmitter is to be fixed-mounted on indoor permanent structures providing a separation distance of at least 20 cm / 8 inches from all persons during normal operation and must not be co-located or operating in conjunction with any other antenna or transmitter. The maximum radiated output power is 1W e.i.r.p. For more information and technical support, please refer to www.Spectralink.com.

Recording the Installation Information

After completing the installation of the repeaters, record the location of each repeater.

Checking Indicators

Verify that the repeater LED indicator is continuously on, indicating that the repeater is functional.

Powering the Spectralink Repeater

Power Options

The power supply for the repeater is 9VDC, 300mA.

Programming with the Spectralink Programming Kit

This section describes how you program the Spectralink Repeater.

Content of the Spectralink Programming Kit Repeater

The Programming Kit Repeater (Part no. 02509210) consists of a splitter and a serial cable.



Note

For programming the repeater you also need the programming software (ServiceTool) and the power supply for the repeater. The ServiceTool is not part of the Programming Kit Repeater but can be downloaded from www.Spectralink.com. The power supply for the repeater is to be ordered separately (Part no. 84642602).

Figure 12 Programming Kit Repeater



Set up of the Hardware for Repeater Programming

Before you set up the hardware ensure that you have an appropriate power supply that meets local requirements.

Follow the set up order closely.

- 1 Unplug the repeater power supply and insert the splitter.
- 2 Connect the repeater power supply to the splitter and the mains. LED flashes.
- 3 Connect the serial cable to the splitter and Com port of your computer.

The repeater is now ready for programming via the ServiceTool.

Programming the Spectralink Repeater with the ServiceTool

The ServiceTool is the tool you access from your desktop and use for repeater programming, handset adjustment and software download to the handset and repeater.

The ServiceTool identifies the type of repeater, and with this software it is possible to program the Spectralink Repeater to connect to the Spectralink DECT Radio Infrastructure solutions.

Before you start programming the repeater, ensure that the repeater is connected to the computer and the mains.

In a multi cell solution, the numbering of the base stations and repeaters has to follow the numbering in [Appendix 1](#).



Note

Repeater and base station numbers must not be the same. Neither can the repeater have a number similar to another base station or another repeater in a situation where common overlap is present between the actual units (Numbers with red colour show where numbering could be identical between different units). If this occurs, handover between the different units is not possible.

Numbering of base stations and repeaters in a normal configuration	
First repeater	No. of base station + 64 Base to synchronize on: Number of base station
Second repeater	No. of base station + 128 Base to synchronize on: Number of base station
Third repeater	No. of base station + 192 Base to synchronize on: Number of base station

Numbering of repeaters in a repeater jump configuration	
First repeater in chain	No. of base station + 64 Base to synchronize on: Number of base station
Second repeater in chain	No. of base station + 128 Base to synchronize on: Number of previous repeater
Third repeater in chain	No. of base station + 192 Base to synchronize on: Number of previous repeater



Note

For programming the repeater you also need the programming software (ServiceTool) and the power supply for the repeater. The ServiceTool is not part of the Programming Kit Repeater but can be downloaded from www.Spectralink.com. The power supply for the repeater is to be ordered separately (Part no. 84642602).

For more information about programming the repeater with the ServiceTool, refer to the Help File in the ServiceTool. The ServiceTool is to be downloaded from www.spectralink.com.

Use of Spectralink Repeater With External Antenna

If radio coverage between a base station and a repeater is not needed, it is possible to synchronize between the radio units using a repeater with external antenna.

Figure 13 Use of Repeaters

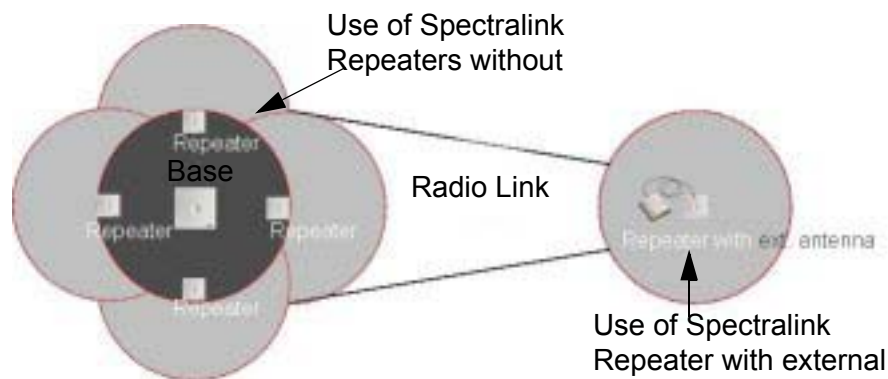

The distance from the repeaters without external antenna to the base station must correspond to a RSSI loss of maximum 25dB.

Be aware that inside the area named “radio link” there is no radio coverage, and therefore a wireless handset cannot be used in this area.

The distance between the base station and the repeater with external antenna depends on the type of antenna used as well as on the signal attenuation created by surroundings such as buildings, trees, etc.

Synchronization Ways

The repeater with external antenna, 4 channels, can be programmed to obtain synchronization on two radio units (base station or repeater).

If a situation occurs where the primary sync for some reason breaks down, the repeater will obtain sync on the alternative sync.

Be aware that the primary sync has priority; the alternative sync is only in use as long as the primary sync is down.

Chapter 6: Basic Network Configuration

This section provides you with information on basic network configuration. Basic network settings can be derived from a DHCP server or entered manually through TCP/IP Setup.

Using DHCP the device requests and obtains an available IP address from a DHCP server. The device also obtains other parameters such as the default gateway, subnet mask, DNS server, Time server and other IP parameters from the DHCP server.

Using manual TCP/IP Setup the IP addresses and other networking parameters are entered manually through the web based Administration Page. The static IP addresses are unique, provided and managed by your system administrator.

Recommended Network Configuration

When configuring a Spectralink IP-DECT Server 6500 Solution, it is strongly recommended to configure:

- Spectralink IP-DECT Server 6500 using static IP address
- Media resources using DHCP
- Base stations using DHCP

**Note**

When using DHCP on base stations and media resources, the Spectralink IP-DECT Server 6500 must have either a static IP address or IP address reservations assigned to the DHCP server.

**Note**

When the Spectralink Wireless devices are set up to DHCP, you need to use UPnP to discover the Wireless devices. The devices will appear under Network and Other Devices as “<device name>-<Serial number>”, for example, Spectralink IP-DECT Server 6500-8442621 or MR6500-84532341.

If the Spectralink IP-DECT Server 6500 Solution is configured as recommended above, it is possible to assign options to the DHCP server making it extremely easy to configure all media resources and base stations.

If the Spectralink IP-DECT Server 6500 is configured using DHCP, it is necessary to assign a reservation for the device on the DHCP server.

Assigning DHCP Server Options

You can provide information about the static IP address of the Spectralink IP-DECT Server 6500 in the DHCP server through DHCP options. When defining the IP address of the Spectralink IP-DECT Server 6500 in the DHCP server, all media resources and base stations are configured automatically.

Below you will find a description of how to assign options to a DHCP server when opening a DHCP server console (MS 2000/2003 DHCP Server):

- When adding a new class you must enter the following information:
 - Display name: **Spectralink IP6500**
 - Description: **Spectralink IP-DECT Server 6500 Solution**
 - ASCII: **KIRK.IP6000** (case sensitive)
- When adding a new option you must enter the following information:
 - Name: **Spectralink IP-DECT Server 6500**
 - Type: **String**
 - Code: **43**
- Select options **43**.
- Enter the IP address of the Spectralink IP-DECT Server 6500.

Assigning DHCP Server Reservations

If the Spectralink IP-DECT Server 6500 is configured using DHCP, it is necessary to assign a reservation for the device on the DHCP server. For more information about this feature, contact your network administrator.

Chapter 7: Configuring the IP-DECT Server 6500

This section provides you with information on how to power up the Spectralink IP-DECT Server 6500 and connect the unit to a computer. It also provides information on how to configure a Spectralink IP-DECT Server 6500 through the web based Administration Page using either DHCP or static IP address.



Note

The Spectralink IP-DECT Server 6500 is pre-configured to use a DHCP assigned IP address. If no DHCP server is available, connect directly to the server using a patch cable. Then wait one minute for the server to fall back to the IP address: 192.168.0.1.

Discovering the Spectralink IP-DECT Server 6500 via UPnP

The Spectralink IP-DECT Server 6500 is setup with DHCP enabled by default. You therefore have to use UPnP to discover the Spectralink IP-DECT Server 6500. The Spectralink IP-DECT Server 6500 will appear under Network and Other Devices as "Spectralink IP-DECT Server 6500-<Serial number> ", for example Spectralink IP-DECT Server 6500-8442621.

Figure 14 Using UPnP to discover Spectralink IP-DECT Server 6500

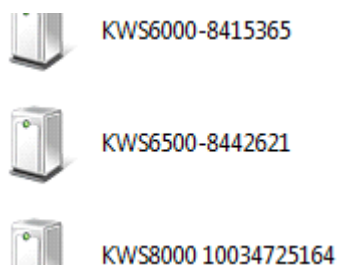

Double-click the icon to access the Spectralink IP-DECT Server 6500 web user interface.

Accessing the Web Based Administration Page

The Spectralink IP-DECT Server 6500 can only communicate with the network through a patch cable connected to a 10/100-Mbit/s Switch port.



Note

The LAN port of the Spectralink IP-DECT Server 6500 is a RJ45 connector.

Figure 15 Direct connection patch cable (RJ45)

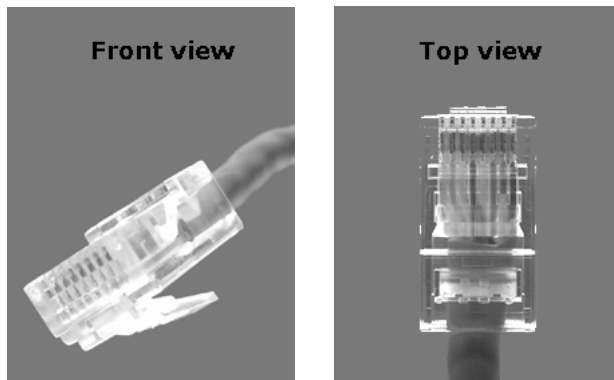

- 1 Connect the direct connection patch cable to the computer.



- 2 Connect the patch cable to the **LAN** port of the Spectralink IP-DECT Server 6500.



How to Access the Administration Page

The web based Administration Page is accessed through a standard web browser.

- 1 Open a web browser.
- 2 In the browser's **Address** bar, type 192.168.0.1 or the IP-address discovered by UPnP, and then press **ENTER**.

The Spectralink IP-DECT Server 6500 Administration Page appears.

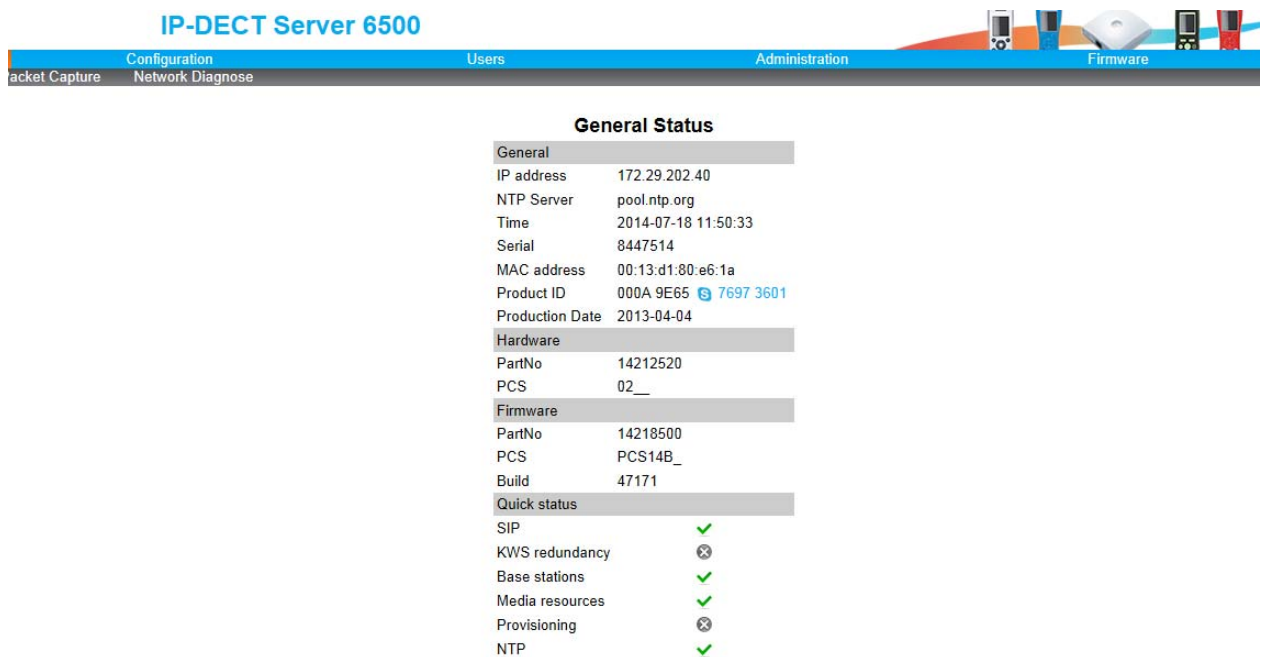
Figure 16 Main page of the Administration Page for wireless server

The screenshot shows the Administration Page for the IP-DECT Server 6500. The page has a blue header with the title "IP-DECT Server 6500" and navigation tabs for "Configuration", "Users", "Administration", and "Firmware". Below the header, there are several sections of information:

General Status	
General	
IP address	172.29.202.40
NTP Server	pool.ntp.org
Time	2014-07-18 11:50:33
Serial	8447514
MAC address	00:13:d1:80:e6:1a
Product ID	000A 9E65 7697 3601
Production Date	2013-04-04
Hardware	
PartNo	14212520
PCS	02_
Firmware	
PartNo	14218500
PCS	PCS14B_
Build	47171
Quick status	
SIP	✓
KWS redundancy	✗
Base stations	✓
Media resources	✓
Provisioning	✗
NTP	✓

Entering a System User Name and Password

When you access the Administration Page, you need to log on with a user name and a password.



Note

The default user name of the system is **admin** and the default password of the system is **admin**. It is strongly recommended that you change the password.

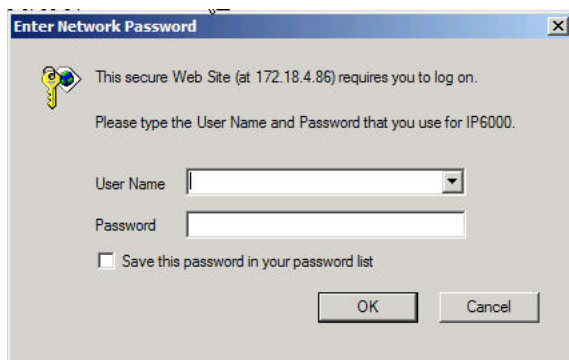
Figure 17 Adm. Page: Enter Network Password dialog box

The dialog box titled "Enter Network Password" contains the following text and fields:

This secure Web Site (at 172.18.4.86) requires you to log on.
Please type the User Name and Password that you use for IP6000.

User Name:

Password:

Save this password in your password list

Buttons: OK, Cancel

- 1 In the **User Name** field, type **admin**.
- 2 In the **Password** field, type **admin**.
- 3 Click **OK**.

Configuring a Spectralink IP-DECT Server 6500 Using Static IP Address

This section describes how to configure a Spectralink IP-DECT Server 6500 using a static IP address.



Note

Because the Spectralink IP-DECT Server 6500 is a critical part of the SIP infrastructure, it is highly recommended that you do not use DHCP. Using a static IP address is the preferred method.

Figure 18 Spectralink IP-DECT Server 6500 installation

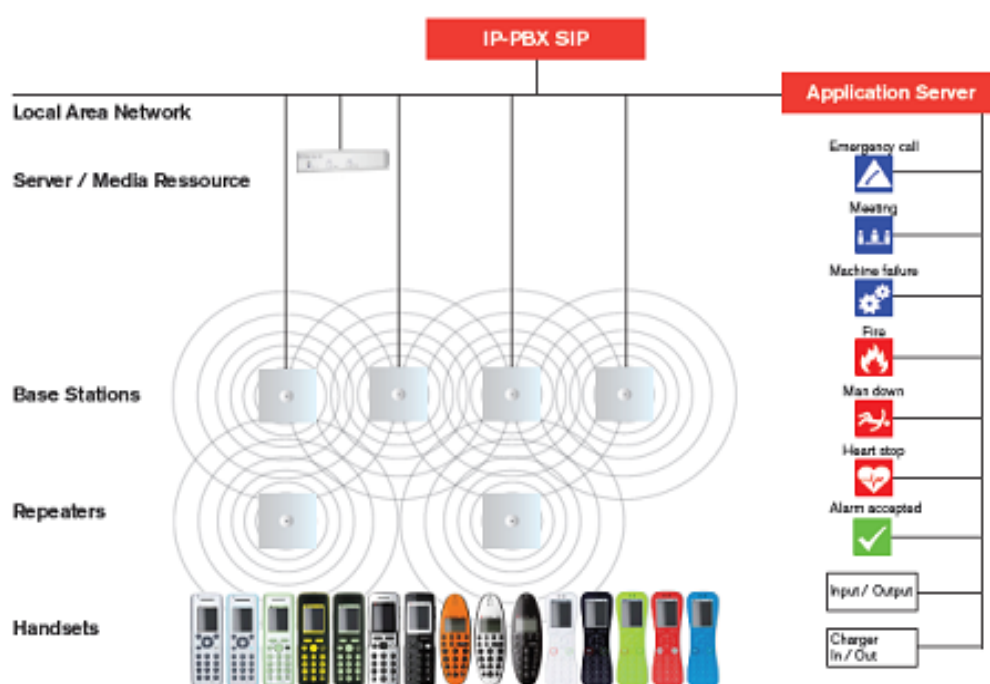

General Configuration

On the **Configuration/General** page you define IP, DNS and NTP settings for the Spectralink IP-DECT Server 6500.

- 1 Click **Configuration**, and then click **General**.

Figure 19 Adm. Page WS: Configuration/General page

IP-DECT Server 6500

Configuration Users Administration

Security Certificates SIP Lync Provisioning Redundancy Import/Export Firmware

General Configuration

IPv4

Method * ** Use static IP address ▾

IP addr ** 172.29.202.40

Netmask ** Static IPv4 address assigned to the device. 0

Gateway ** 172.29.192.1

MTU **

IPv6

Method ** Disabled ▾

Address/prefix **

Default gateway **

Ethernet

VLAN **

DNS

Hostname **

Domain **

Primary Server ** 172.29.129.47

Secondary Server ** 172.29.129.54

NTP

Server pool.ntp.org

Time zone Amsterdam, Barcelona, Berlin, Brussels, Copenhagen, Paris, Stockholm ▾

Posix timezone string CET-1CEST-2,M3.5.0/02:00:00,M10

UPnP

Enabled **

Broadcast announcements **

Remote syslog

Host

Port * 514

Facility * 16 Local 0 ▾

Level * info ▾

SNMP

Enabled **

2 Click Use Static IP Address.**3** In the **IP Addr** field, type the IP address of the Spectralink IP-DECT Server 6500.**4** In the **Netmask** field, type a new network mask.

Contact your system administrator for more information.

5 In the **Gateway** field, type the IP address of the default gateway.

The default gateway serves as an access point to another network.

Contact your system administrator for more information.

6 In the **MTU** field (Maximum Translation Unit), type the size of the largest packet, that your network protocol can transmit (optional).**7** In the **Domain** field, type the domain name of the system (optional).**8** In the **Server** field (under **DNS - Domain Name System**), type the IP address of the DNS server (optional).

- 9 In the **Server** field (under **NTP - Network Time Protocol**), type the IP address of the NTP server from which the system will obtain the current time.
- 10 From the **Time Zone** list, select the wanted time zone.
- 11 Click **Save** to save your general configuration data.

Wireless Server Configuration

On the **Configuration/Wireless Server** page you configure the Spectralink IP-DECT Server 6500 to allow subscription. If the system does not allow subscription, it is not possible to subscribe a handset.

- 1 Click **Configuration**, and then click **Server**.

Figure 20 Wireless Server Configuration

The screenshot shows the configuration page for the IP-DECT Server 6500. The navigation bar includes 'Configuration', 'Users', 'Administration', and 'Firmware'. The 'Configuration' section is active, with sub-tabs for 'Security', 'Certificates', 'SIP', 'Lync', 'Provisioning', 'Redundancy', and 'Import/Export'. The 'Wireless Server Configuration' section is expanded, showing various settings:

- DECT**
 - Subscription allowed:
 - Authenticate calls:
 - Encrypt voice/data:
 - System access code:
 - Send date and time:
 - Frequency **:
- Media resources**
 - Allow new:
- Base stations**
 - Allow new:
 - Media encryption (SRTP) **:
 - Multicast signaling **:
 - Multicast address **:
 - Multicast TTL **:
- Application interface**
 - Username *:
 - New password:
 - New password again:
 - Enable MSF:
 - Enable XML-RPC:
 - Internal messaging:
- Feature codes**
 - Enable:
 - Call forward unconditional - enable:
 - Call forward unconditional - disable:
- Language**
 - Phone Language **:

Buttons for 'Save' and 'Cancel' are located at the bottom of the configuration area. A note at the bottom indicates: *) Required field **) Require restart

- 2 Select the **Subscription Allowed** check box (optional).
Note: If not selected, you cannot subscribe a handset.
- 3 Click **Save**.

Built-In Media Resource Configuration

On the **Configuration/Media Resource** page you configure the built-in media resource.

- 1 Click **Configuration**, and then click **Media Resource**.

Figure 21 Adm. Page WS: Configuration/Media Resource page

The screenshot shows the 'Media Resources' configuration page. At the top, there's a navigation bar with tabs for Status, Configuration, Users, Administration, Firmware, and Statistics. Under 'Configuration', there are sub-tabs for Wireless Server, License, Media Resource, Base Station, Clusters, Phonebook, and Backup. The 'Media Resource' tab is active. Below the navigation, there's a search bar and a table of media resources. The table has columns for No, Serial, Description, Cluster, Firmware, Status, Uptime, Max. Channels, and Codec. One entry is shown: No. 0, Serial 8447514, Description Internal Primary SRV/MR, Cluster Default, Firmware PCS14B_, Status connected (with a green checkmark), Uptime 14:04:11:02, and Max. Channels 32. Below the table, it says 'Showing 1 to 1 of 1 entries' and there are navigation buttons: First, Previous, 1, Next, Last.

- 2 Select **Enable internal** if you want to activate the built-in media resource.
- 3 Click **Save**.

SIP Configuration

On the **Configuration/SIP** page you define general SIP settings, information about authentication, DTMF signalling, message waiting indication and media.

- 1 Click **Configuration**, and then click **SIP**.

Figure 22 Adm. Page WS: Configuration/SIP page

The screenshot shows the 'SIP Configuration' page. At the top, there's a navigation bar with tabs for Configuration, Users, Administration, and Firmware. Under 'Configuration', there are sub-tabs for Security, Certificates, SIP, Lync, Provisioning, Redundancy, and Import/Export. The 'SIP' tab is active. Below the navigation, there's a 'SIP Configuration' section with a 'General' sub-section. The settings are: Local port (5060), Transport (UDP), DNS method (A records), Default domain (172.29.202.69), Register each endpoint on separate port (unchecked), Send all messages to current registrar (checked), Registration expire (3600), Max forwards (70), Client transaction timeout (4000), SIP type of service (0), SIP 802.1p Class-of-Service (3), GRUU (checked), Use SIPS URI (checked), TLS allow insecure (unchecked), and TCP ephemeral port in contact address (unchecked). Below the 'General' section, there's a 'Proxies' section.

2 Apply the desired values as described in the following table

Field	Explanation	Required	Optional
SIP Configuration - General			
Local Port	Enter the local port number. The default local port number is 5060. The local port is the port on which the IP-DECT Server 6500 listens for incoming SIP-signalling	x	
Transport	Transport mechanism used for SIP messages. possible settings: UDP, TCP or TLS	x	
Field	Explanation	Required	Optional
DNS method	Is used for looking up the destination of SIP messages. Possible settings: A records and DNS SRV	x	
Field	Explanation	Required	Optional
Default Domain	Enter the name of the domain. Note: If no user specific domain is configured under a specific user, the handsets registered on the IP-DECT Server 6500 will use the default domain as the domain part of the SIP URI; e.g. John Doe <sip:1234@somecompany.com If only one SIP pbx is used and no domain is available, enter the IP address of IPBx here.	x	
Register each endpoint on separate port**	Use separate local ports for each endpoint instead of using the global local port.		x
Send all messages to current registrar **	When more proxies are available send all non-REGISTER requests to the current registrar.		x
Registration expire (sec)	The maximum time between re-registrations. The registrar can signal a shorter time-out. Default value: 3600 sec		x
Max forwards	The maximum number of proxies outgoing messages are allowed to traverse. Default value: 70		x

Field	Explanation	Required	Optional
Client transaction time-out (msec)*	Client transaction time-out. This controls timer B and F as specified in RFC3261. Increase this to eliminate time out errors or decrease it to reduce fail over time. Default value: 4000ms		x
SIP type of service (TOS/Diffserv)	TOS/Diffserv used for SIP signaling. Enter in decimal. Default setting: 96		x
SIP 802.1p Class-of-Service*	This is the 802.1p PCP and must be between 0 and 7. The setting requires VLAN tagging. Default value: 3		x
GRUU	Enable Globally Routable User Agent URIs. Default value: Enabled		x
Use SIPS URI	Normally SIP communication on a TLS connection uses the SIPS: URI scheme. Disabling this option causes the KWS to use the SIP: URI scheme with a transport=tls parameter for TLS connections. Default value: Enabled		x
TLS allow insecure **	By default UDP and TCP transports are disabled when TLS transport is the default. If this setting is enabled, UDP and TCP are allowed as fallback if TLS fails. Default value: Disabled		x
Proxy	Enter SIP proxy. The proxy is the SIP URI of the SIP-proxy. The IP-DECT Server 400 will route all outgoing SIP signalling to the proxy, e.g. SIP registrations and outgoing calls.		x
SIP Configuration - Proxies			
Proxy 1-4	Priority: The priority for using this proxy. Possible Value 1-4. Weight: The weight for using this proxy if more proxies have the same priority. Possible value 1 - 65.000 higher weight gives priority. Default value: 100. URI: The URI or IP address of the proxy		x

Field	Explanation	Required	Optional
SIP Configuration - Authentication			
Field	Explanation	Required	Optional
Default User	Default user name used for SIP authentication. Note: If no handset specific authentication user name/password is configured, handsets registered on the IP-DECT Server 6500 will use the default user name/password for authentication.		x
Default Password	Enter password.		x
Realm	The realm presented by the proxy when requesting authentication. If this field is non-empty, authentication passwords will be encrypted. Note that when the realm is changed all stored passwords will be invalid.		x
SIP Configuration - DTMF Signalling			
Send as RTP	If checked, keypad signaling will be sent as RTP event codes.		x
Send as SIP Info	If checked keypad signalling will be sent as SIP INFO messages.		x
Tone Duration (msec)	Enter the time length of the tone in milliseconds. The default value is 270		x
SIP Configuration - Message Waiting Indication			
Enable Indication	Enable the check box, if you want to display MWI in the handset.		x
Enable Subscription	Enable the check box, if you want to subscribe to MWI indications from the SIP proxy.		x
Subscription Expire (sec)	Enter the number of seconds before MWI subscription will be renewed. The default value is 3600		x
SIP Configuration - Media			
Packet Duration (msec)	Select between 10, 20 and 40 msec.	x	
Media Type of Service (TOS/Diffserv)	OS/Diffserv used for RTP (Media) signaling entered in decimal. The default setting is 184		x
Media Type of Service (TOS/Diffserv)	This is the 802.1p PCP and must be between 0 and 7. The setting requires VLAN tagging. Default value: 5. X in optional		x
Port Range Start	Port range used for RTP. The default value is 58000		x

Field	Explanation	Required	Optional
Codec priority	Define the priorities of codecs. Values: PCMU/PCMA (G.711 ulaw/alaw), G.726, G.729.	x	
SDP answer with preferred codec	Specifies if the media handling should ignore the remote SDP offer codec priorities.		x
SDP answer with a single codec	Specifies if the media handling should provide only a single codec in SDP answers.		x
Ignore SDP version	Ignore the version of the SDP received from remote endpoints.		x
SIP Configuration - Call Status			
Play on-hold tone	Enable check box to receive on-hold tone when placed on hold.	x	
Display status messages	Enable check box to receive status messages in the handset display.	x	
# key ends overlap dialing	Pressing the pound key dials number in overlap dialing.		x
Call waiting	Enable call waiting		x

3 Click **Save** to save the SIP configuration data.

Security Configuration

It is possible to change the password for the unit from the **Configuration/Security** page.

1 Click **Configuration**, and then click **Security** (optional).

Figure 23 Adm. Page: Configuration/Security page

The screenshot shows the 'IP-DECT Server 6500' administration interface. The navigation bar includes 'Configuration', 'Users', 'Administration', and 'Firmware'. The 'Configuration' tab is active, and the 'Security' sub-tab is selected. The 'Security Configuration' section is displayed, featuring the following elements:

- Administrator Authentication:**
 - Current password * (text input field)
 - New username * (text input field containing 'admin')
 - New password (text input field)
 - New password again (text input field)
- Remote Access:**
 - Force secure HTTP (TLS)
 - Allow remote logging
- Buttons: 'Save' and 'Cancel'
- Footnote: *) Required field **) Require restart

2 In the **Current password** field, type the current password.

3 In the **New username** field, type a new username.

4 In the **New password** field, type a password.

- 5 In the **New password again**, type the password again.
- 6 Click **Allow remote logging** if it should be possible to perform remote logging (Useful in case of problem solving).
- 7 Select **Force Secure HTTP (TLS)** if you prefer this option. The setting is optional
- 8 Click **Save**.

Checking Indicators

- Verify that the Spectralink IP-DECT Server 6500/media resource LED indicator is continuously on, indicating that the Spectralink IP-DECT Server 6500/media resource is functional.



Note

The LED will not be green until the base stations have been configured.

Deployment of a Multi-Cell Solution

This section contains deployment information specific to the Spectralink IP-DECT Server 6500.

Sync over Air

As a user moves from one base station radio coverage area to another, the call must be handed over to the next radio unit. To create handover between radio units it is necessary to establish synchronization chains. If the synchronization between radio units is lost, then handover is not possible and ongoing calls will be terminated.



Note

Each base station must be placed within the radio coverage area of at least one other base station or repeater (radio units).

Synchronization Chains Considerations

Certain rules must be taken into consideration when establishing synchronization chains:

- The distance over which synchronization can take place is limited to a distance similar to a loss of max. 25 dB. If the loss of signal is higher than 25 dB, there is no guarantee that synchronization is stable.
- It is recommended that a base station synchronizes with at least two other radio units and that an alternative sync way is defined to ensure system redundancy. If the primary sync way is not working, then the alternative sync way takes over and the synchronization chain is not broken.
- Synchronization chains for the IP-DECT Server 6500 Solution can be made with base stations and repeaters.
- As you can only configure a repeater to synchronize on one radio ID, it is not possible to define alternative sync ways for repeaters.
- As the IP-DECT Server 6500 uses the DECT interface to synchronize on, one base station is configured as the Sync Master.

Examples of Synchronization Chains

Sync Chain With One Sync Master (Primary Sync Ways)

Figure 24 Synchronization Chain

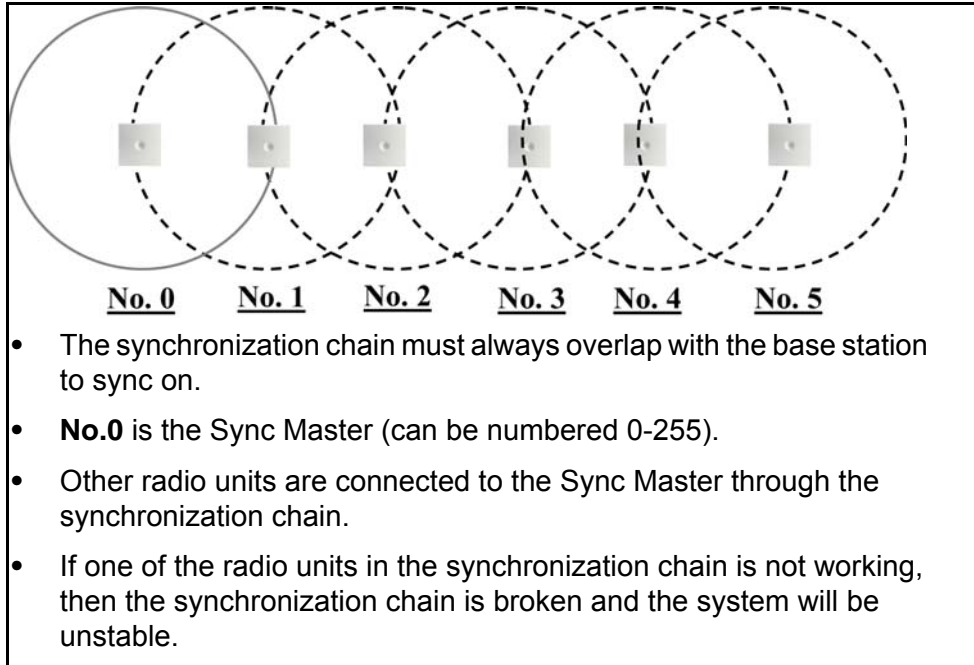
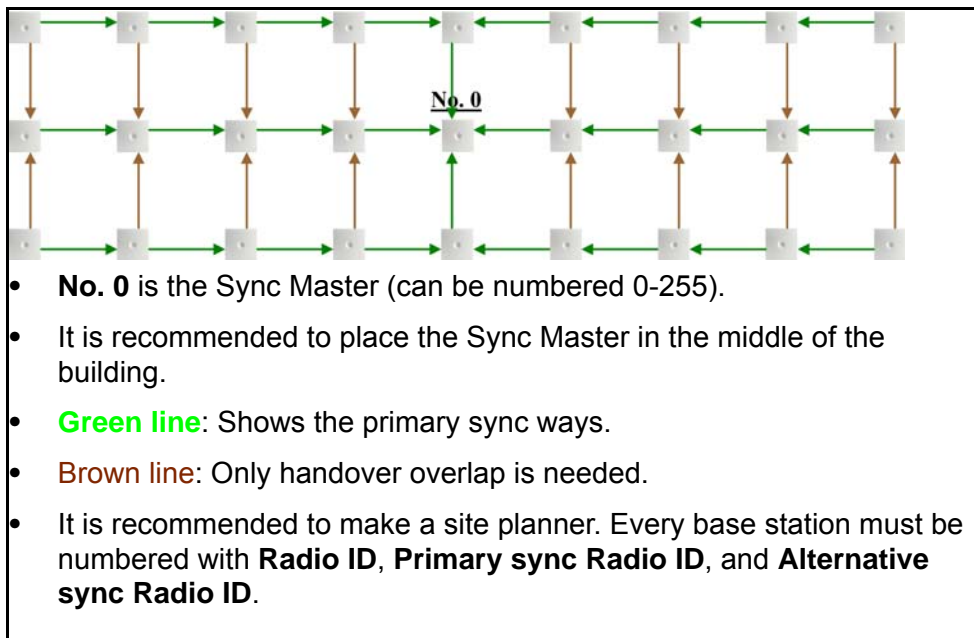
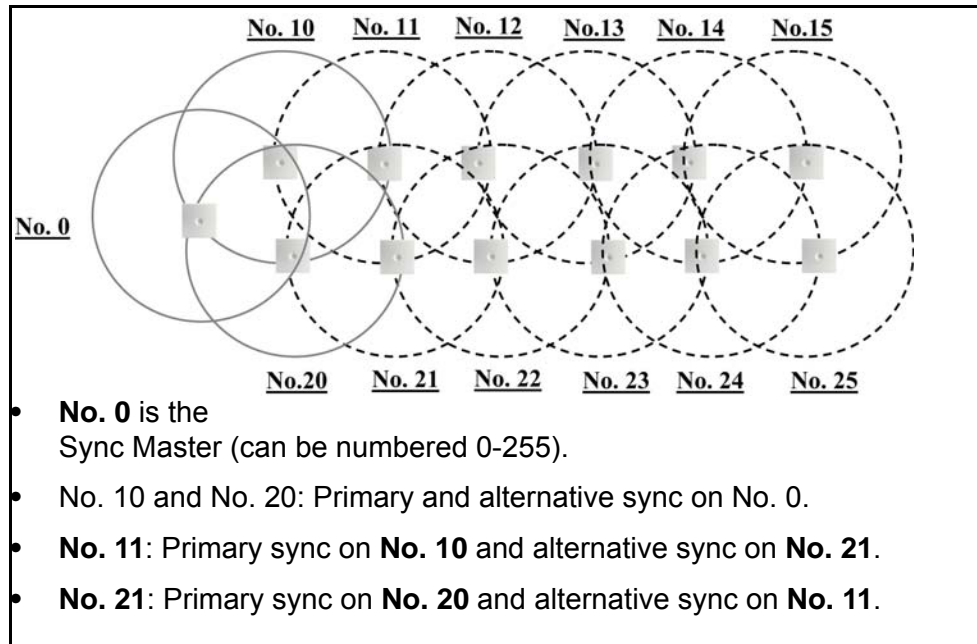

Figure 25 Synchronization Chain Layout without Alternative Sync Ways



Sync Chain With Alternative Sync Ways

Figure 26 Synchronization Chain with Alternative Sync Ways



In the following example, base station **No. 10** is down. As a consequence, base station **No. 11** must use the alternative sync way on **No. 21**.

Figure 27 Synchronization Chain with Alternative Sync Ways

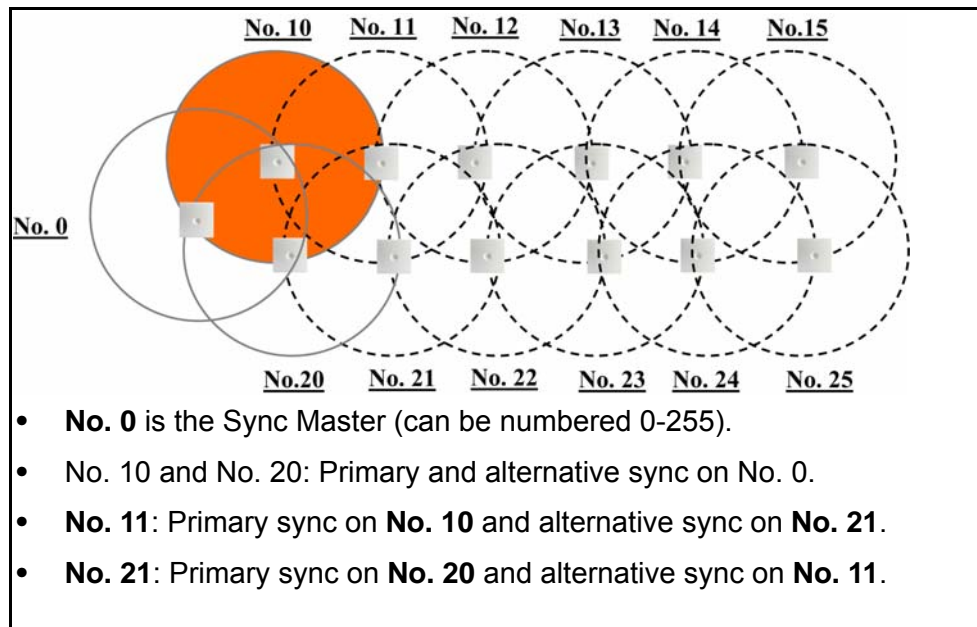

Figure 28 Synchronization Chain with Alternative Sync Ways

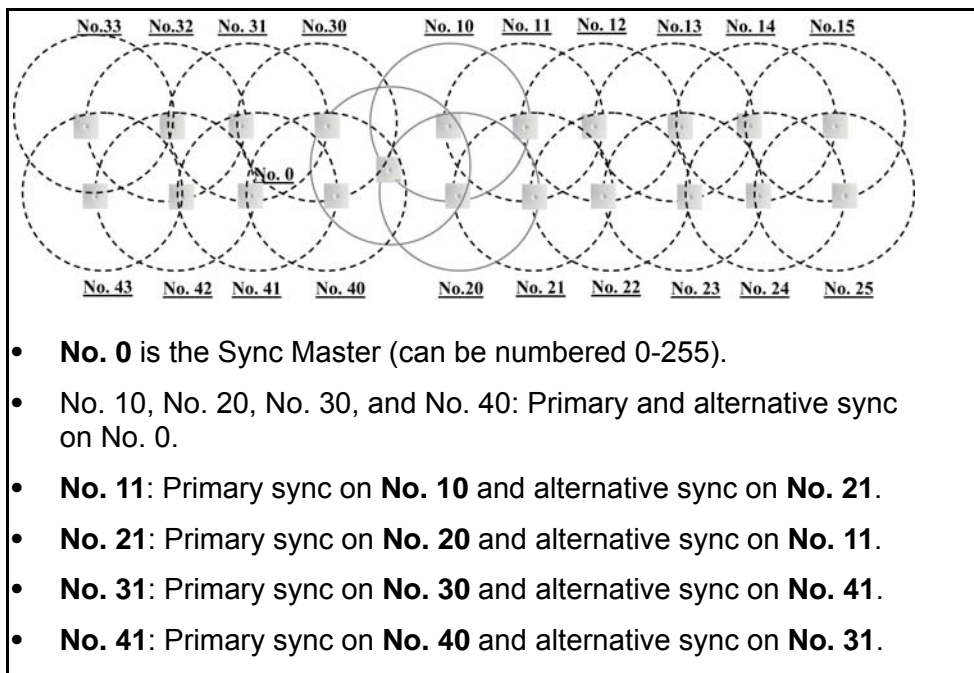
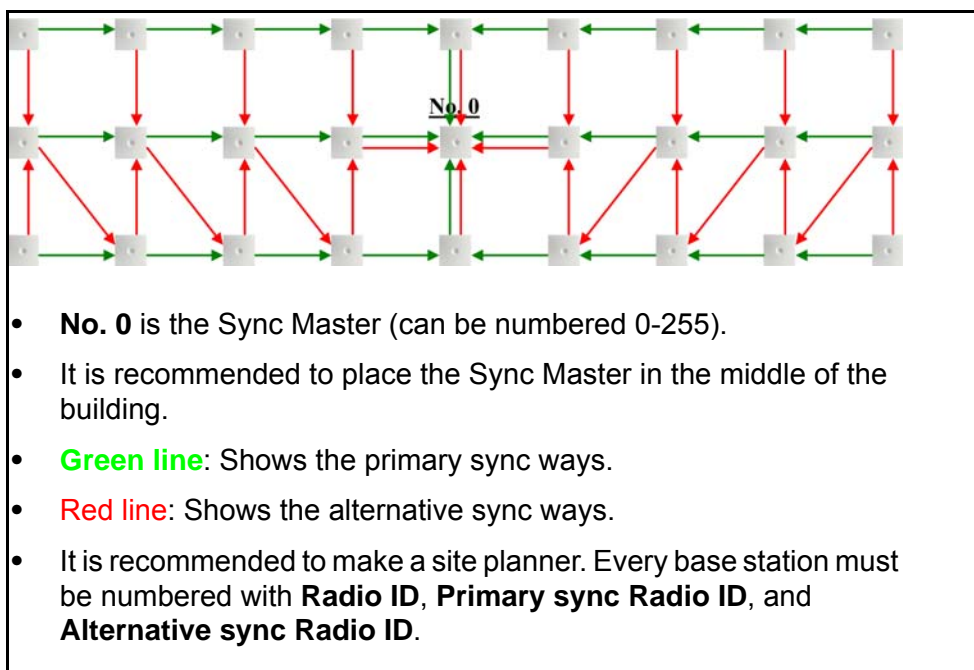

Figure 29 Synchronization Chain Layout with Alternative Sync Ways



Sync Chain With and Without Alternative Sync Ways

Figure 30 Synchronization Chain With and Without Alternative Sync Ways

Figure 31 Synchronization Chain With Repeaters



Chapter 8: Configuring Spectralink Media Resources

This section provides you with information on how to power up the media resource and connect the unit to a computer. It also provides information on how to configure a media resource through the web based Administration Page using either DHCP or static IP address.

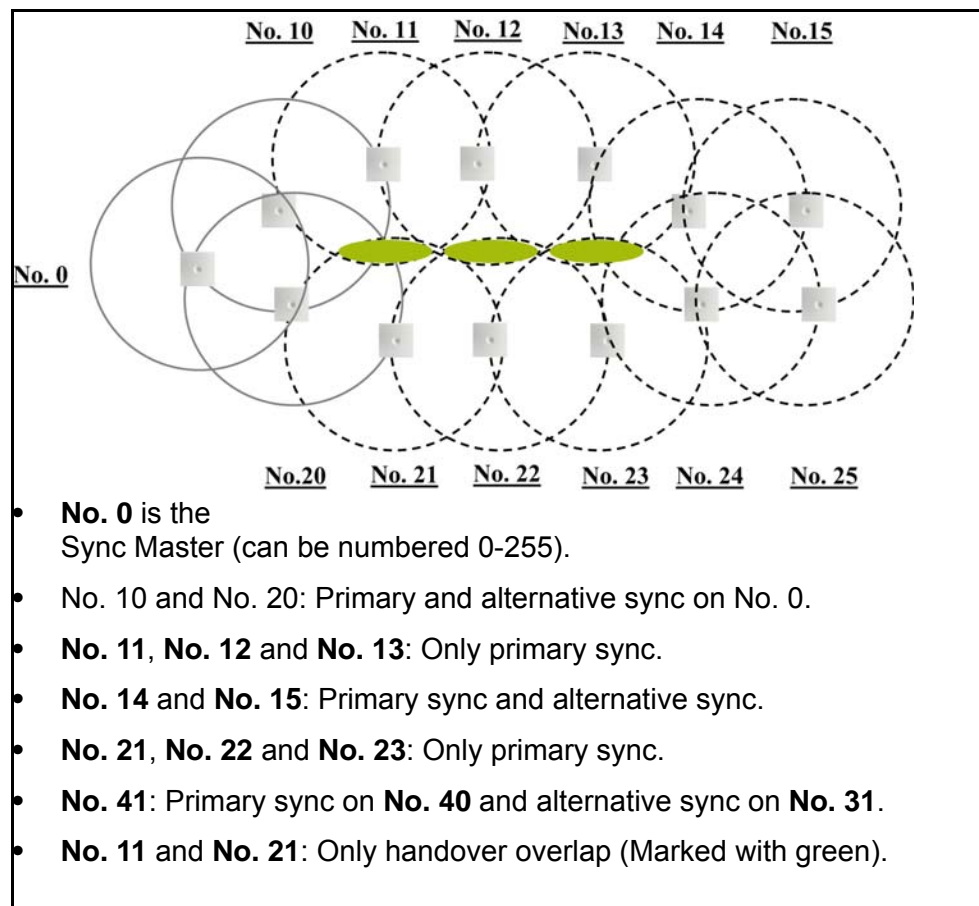
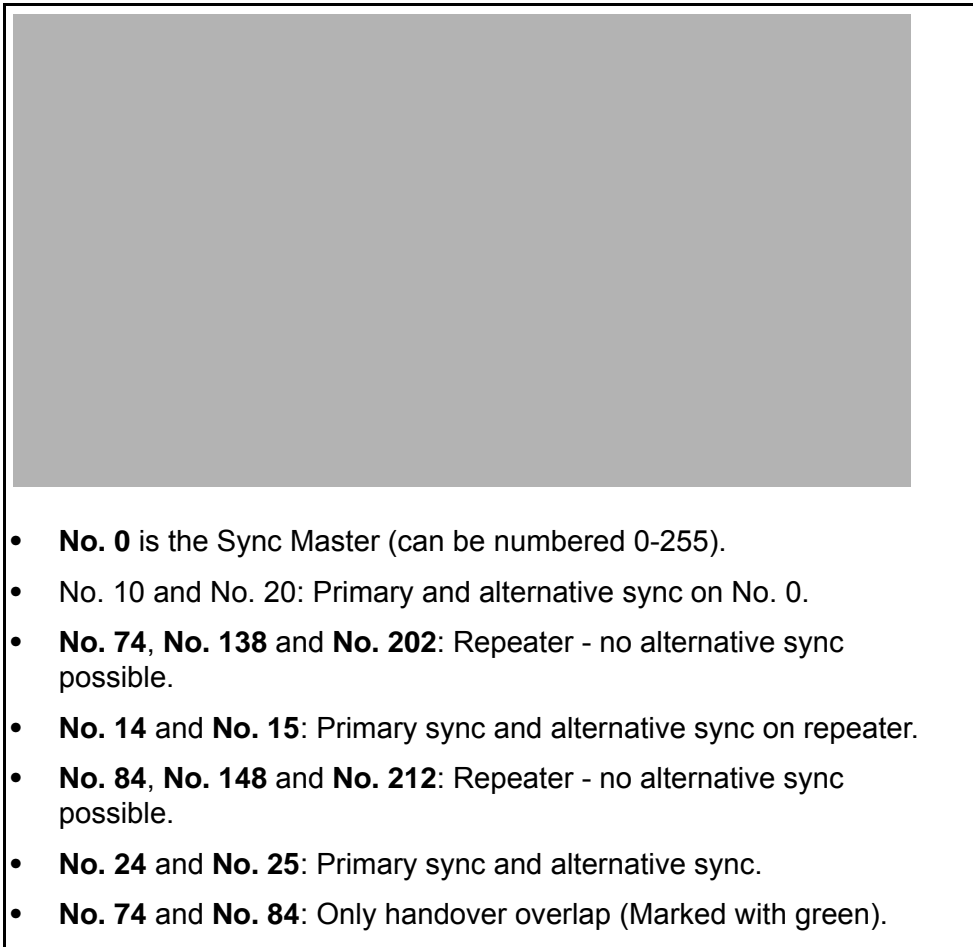

Note

The media resource is pre-configured to use DHCP. It is recommended to configure the media resource using DHCP.

Configuring a Spectralink Media Resource Using Static IP Address

General Configuration

On the **Configuration/General** page you define IP, DNS and NTP settings for the media resource.

Media Resource Configuration

On the **Configuration/Media Resource** page you configure the media resource.

- 1 Click **Configuration**, and then click **Media Resource**.

Figure 32 Adm. Page Media Resource: Config./Media Resource page

No.	Serial	Description	Cluster	Firmware	Status	Uptime	Max. Channels	Codec
	8447514	Internal Primary SRV/MR	Default	PCS14B_	connected	0:03:45:42	32	

- 2 In the **Host** field, type the address of the wireless server.
- 3 Click **Save**.

Checking Indicators

- Verify that the media resource LED indicator is continuously on, indicating that the media resource is functional.



Note

The LED will not turn on until the base stations are configured.

Chapter 9: Configuring Spectralink IP-DECT Base Station

This section provides you with information on how to connect the base station to a Spectralink IP-DECT Server 6500 and how to configure the base station through the web based Administration Page using either DHCP or static IP address.



Note

The base station is pre-configured to use DHCP. It is strongly recommended that you configure the base station using DHCP. When using DHCP the IP base station should be discovered by UPnP

Powering up the Spectralink Base Station

After installing the base station you need to power it up. The base station uses:

- Power over Ethernet (PoE 802.3af).
- Maximum power supply consumption is 3.0W (IEEE 802.3af class 1 device).

Use a standard PoE adapter or a PoE-enabled port on a switch adhering to PoE 802.3af when connecting the base station to a PoE power source.

Use an 8V-DC power supply when using a power supply as power source.

Accessing the Web Based Administration page of the Base Station

The Spectralink IP Base station can only communicate with the network through a patch cable connected to a 10/100-Mbit/s Switch port.



Note

The LAN port of the base station is a RJ45 connector.

Figure 33 Cross-Over Patch Cable (RJ45)

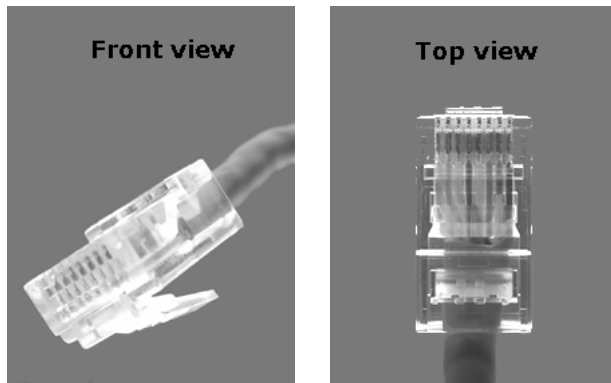

- 1 Connect the LAN cable or cross-over patch cable to the computer.



- 2 Connect the LAN patch cable to the ethernet connector at the bottom of the base station.

Figure 34



Accessing the Web Based Administration Page

The web based Administration Page is accessed through a standard web browser.

- 1 Open a web browser.
- 2 In the browser's **Address** bar, type **http://192.168.0.1** or the IP address discovered by UPnP, and then click **ENTER**.

Note: If no DHCP server is available, the base station will fall back to IP address 192.168.0.1. This happens one minute after startup.

Figure 35 Main page of the Administration Page for base station

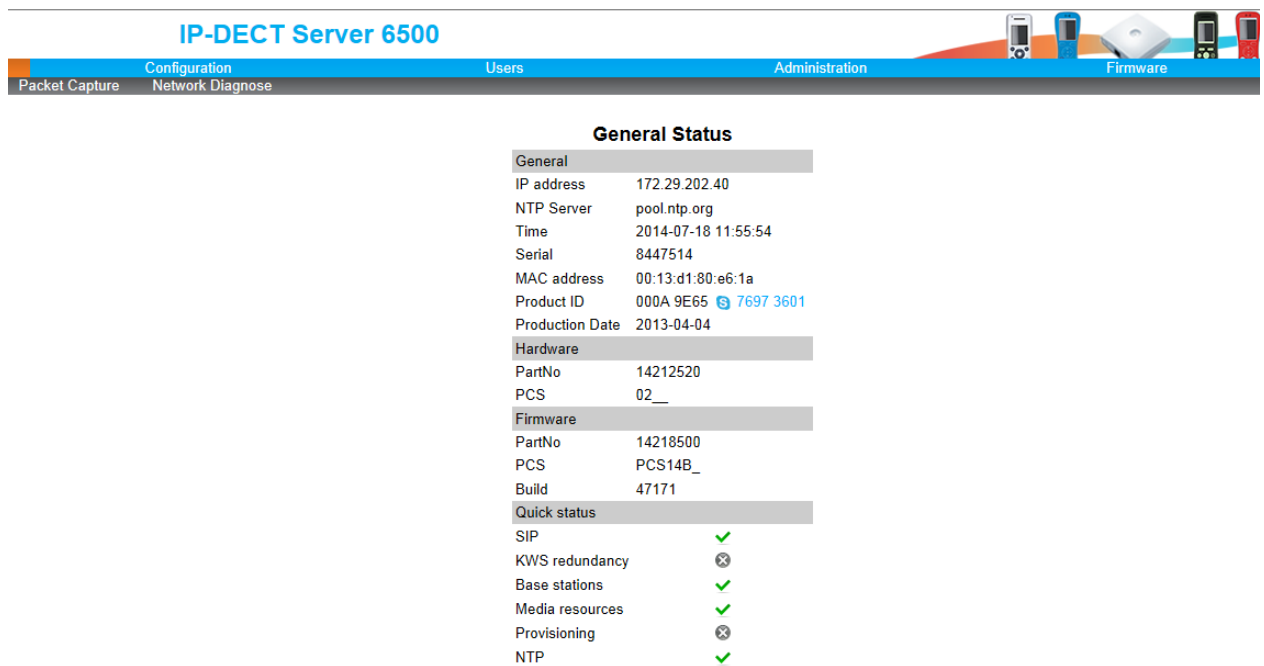

Entering a System User Name and Password

The first time you access the Administration Page, you need to log on with user name and a password.



Note

The default user name of the system is **admin** and the default password of the system is **admin**. It is strongly recommended that you change the password.

Figure 36 Adm. Page: Enter Network Password dialog box

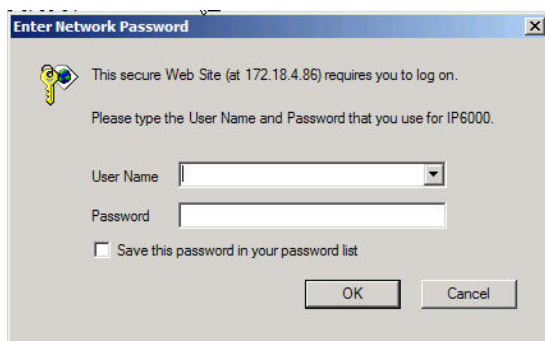

- 1 In the **User Name** field, type **admin**.
- 2 In the **Password** field, type **admin**.
- 3 Click **OK**.

Configuring a Spectralink Base Station

This section describes how to configure a base station.



Note

It is strongly recommended that the base station is configured using DHCP. The base station is pre-configured to use DHCP.

If the Spectralink IP-DECT Server 6500 is configured using a static IP address, it is possible to assign options to the DHCP server making it extremely easy to configure all base stations.

General Configuration

On the **General Configuration** page you define IP, DNS, and NTP settings for the base station.

- 1 Click **Configuration**, and then click **General**.

Figure 37 Adm. Page Base Station: Configuration/General page

The screenshot shows the 'General Configuration' page of the IP-DECT Server 6500 administration interface. The page has a navigation bar with tabs for Configuration, Users, Administration, and Firmware. The 'Configuration' tab is active, and the 'General' sub-tab is selected. The main content area is titled 'General Configuration' and contains several sections with form fields:

- IPv4**: Method (Use static IP address), IP addr (172.29.202.40), Netmask (255.255.240.0), Gateway (172.29.192.1), MTU.
- IPv6**: Method (Disabled), Address/prefix, Default gateway.
- Ethernet**: VLAN.
- DNS**: Hostname, Domain, Primary Server (172.29.129.47), Secondary Server (172.29.129.54).
- NTP**: Server (pool.ntp.org), Time zone (Amsterdam, Barcelona, Berlin, Brussels, Copenhagen, Paris, Stockholm), Posix timezone string (CET-1CEST-2,M3.5.0/02:00:00,M10).
- UPnP**: (Fields are partially visible but mostly obscured).

- 2 Click **DHCP assigned**.
- 3 Apply the desired values as described in the following table.

Field	Explanation	Required	Optional
General Configuration - IP			
Use Static IP Address	Enable the field if you want to use a static IP address.	x	
IP Addr	Enter the IP address of the IP-DECT Server 6500	x	
Netmask	Enter a new network mask. Contact your system administrator for more information.	x	
Gateway	Enter the IP address of the default gateway. The default gateway serves as an access point to another network. Contact your system administrator for more information.	x	
Field	Explanation	Required	Optional
MTU (Maximum Translation Unit)	Enter the size of the largest packet, that your network protocol can transmit		x
VLAN	Enter the VLAN Identifier (VID) according to IEEE 802.1Q specifying the VLAN to which the device belongs. The IP-DECT Server 400 supports 4094 different VLANs. Values: 1-4094		x
General Configuration - DNS (Domain Name System)			
Hostname	The hostname will be inserted into the SIP Contact and via headers. The hostname will also be published via DHCP and if the network infrastructure supports it, the device will be reachable via this hostname.		x
Domain	Enter the name of the domain where system belongs.		x
Primary Server	Enter the IP address of the Primary DNS server		x
Secondary Server	Enter the IP address of the Secondary DNS server		x

General Configuration - NTP (Network Time Protocol)			
Server	Enter the address of the NTP server from which the system will obtain the current time.	x	
Time Zone	Select the time zone.	x	
UPnP			
Enabled	UPnP is an acronym for Universal Plug and Play. If the IP-address of the device is unknown (e.g. forgotten or DHCP-assigned), UPnP can be used to easily identify the IP-address of the device. If "My Network Places" in Windows is setup to show icons for networked UPnP devices, every IP-DECT Server 6500, Media resource and Base station will be present in "My Network Places".	Enabled by default	
Broadcast announcements	Specifies if UPnP announcements are broadcasted. When enabled, the device broadcasts announcements automatically.		x
Host			
Port			
Facility			
Level			

Security Configuration

It is possible to change the password for the unit.

- 1 Click **Configuration**, and then click **Security** (optional).

Figure 38 Adm. Page Base Station: Configuration/Security page

IP-DECT Server 6500

Resource **Configuration** Security Certificates SIP Lync Provisioning Redundancy Import/Export Administration **Firmware**

Security Configuration

Administrator Authentication

Current password *

New username *

New password

New password again

Remote Access

Force secure HTTP (TLS)

Allow remote logging

*) Required field **) Require restart

- 2 In the **Current password** field, type the current password.
- 3 In the **New username** field, type a new username.
- 4 In the **New password** field, type a password.
- 5 In the **New password again**, type the password again.
- 6 Click **Allow remote logging** if it should be possible to log on to the system remotely (Useful in case of troubleshooting).
- 7 Click **Save**.

Base Station Configuration

To configure the base station:

- 1 Click **Administration**, and then click **Base Station**.

Figure 39 Configuration/Base Station

The screenshot shows the 'Base stations' configuration page. The navigation bar includes 'Status', 'Configuration', 'Users', and 'Administration'. The 'Configuration' section is active, with 'Base Station' selected. The table below lists the base station details:

No	Serial	Description	RPN	Cluster	Firmware	Status
22	8464767	L2 Byg 1:767	22	Default	PCS14B_	connected

Showing 1 to 1 of 1 entries

Synchronization: Free running, Synchronized, Searching, Unknown

- 2 In the **Host** field, type the host name of the IP-DECT Server 6500.
- 3 Click **Save**.
- 4 Click **Reboot** to enable the configuration changes.

Sync. Ways Configuration

It is necessary to define the synchronization ways of the base station.

- 1 To define the sync. ways of the base station, open the Administration Page for the Spectralink IP-DECT Server 6500.
- 2 Click **Administration**, **Server**, and then click **Base Station**.

Figure 40 Adm. Page WS:Administration/Base station page

The screenshot shows the 'Base stations' configuration page. At the top, there is a navigation bar with tabs for 'Wireless Server', 'License', 'Media Resource', 'Base Station', 'Clusters', 'Phonebook', 'Backup', 'Users', and 'Administration'. The 'Base Station' tab is selected. Below the navigation bar, there is a 'Base stations' section with a 'Refresh' button, a 'Clear' button, and a 'Loops' button. A table lists the base stations with columns for 'No.', 'Serial', 'Description', 'RPN', 'Cluster', 'Firmware', and 'Status'. The table shows one entry: No. 22, Serial 8464767, Description L2 Byg 1:767, RPN 22, Cluster Default, Firmware PCS14B_, and Status connected. Below the table, it says 'Showing 1 to 1 of 1 entries'. At the bottom right, there is a synchronization status bar with icons for 'Free running', 'Synchronized', 'Searching', and 'Unknown'.

No.	Serial	Description	RPN	Cluster	Firmware	Status
22	8464767	L2 Byg 1:767	22	Default	PCS14B_	connected

3 Double-click on the relevant base station in the list.

Figure 41 Adm. Page WS:Administration/Base station page

The screenshot shows the 'Base station 22 configuration' form. The form is divided into two sections: 'General' and 'Synchronization'. The 'General' section includes fields for 'IP address' (172.29.202.236), 'Description' (L2 Byg 1:767), 'RPN * ***' (22), 'Cluster *' (Default), and a 'Disabled' checkbox. The 'Synchronization' section includes a 'Type' dropdown menu (LAN), an 'Auto radio sync (deployment only) ***' checkbox, and two 'RPN ***' fields for 'Primary radio sync (RPN) ***' and 'Secondary radio sync (RPN) ***', both set to 0. At the bottom of the form, there are buttons for 'Save', 'Delete', 'Cancel', and 'Reboot base station'. A note at the bottom states: '* Required field *** Changing will automatically reboot base station'.

4 In the **RPN** field (Radio Part Number), type the radio part number of the base station.

The radio ID can be a number between 0 and 255. See your site planner.

Note: The default value of the RPN is equal to the base station number. It is strongly recommended not to change this value.

5 It is possible to select **Auto sync** if you are deploying and want to find a sync way for the first base station.

Note: **Auto sync** is only to be used in a deployment situation. When selecting **Auto sync**, radio part numbers in the **Primary sync. (RPN)** field and **Secondary sync. (RPN)** field are not taken into consideration.

6 In the **Primary sync. (RPN)** field, type the radio part number of the base station, you want to synchronize on. See your site planner.

7 In the **Secondary sync. (RPN)** field, type the radio part number of the base station, you want to synchronize on. See your site planner.

8 Click **Save**. The base station will reboot automatically and reconnect to the server.

Checking Indicators

- Verify that the base station LED indicator is continuously on, indicating that the base station is functional.

Chapter 10: Spectralink Handset Registration

This section provides information about handset registration. You must register and subscribe a handset before you can use it.



Note

This section only describes how to register handsets on the Spectralink IP-DECT Server 6500. You also need to register the users on the call handler. For registering users on the call handler, refer to the call handler user guide.

When registering handsets you enter information about the handsets settings (such as; the handsets serial number (IPEI), name etc.) in the system database. When subscribing handsets you subscribe a registered handset to the system for usage. If the handset is not registered in the system database, subscription of the handset is not possible.

Registering Spectralink Handsets

To register handsets you use the web based Administration Page of the Spectralink IP-DECT Server 6500.

Each handset in the wireless solution must be programmed with the serial number (IPEI) before it can operate. This serial number must be registered in the web based Administration Page of the Spectralink IP-DECT Server 6500. Serial numbers are a unique fingerprint of each handset. The serial number is programmed into the handset during the manufacturing process and cannot be changed by field personnel.



Note

The Spectralink IP-DECT Server 6500 does not provide any service to a handset whose serial number is not registered on the web based Administration Page.

- 1 Click **Users** and then click **List Users**.

Figure 42 Adm. Page WS: Users/List Users page

The screenshot shows the 'IP-DECT Server 6500' Administration page. The 'Users' tab is selected. The 'User List' section includes an overview with the following data:

User List			
Overview			
System ARI	10046546160 [10 26 b3 1c 00]		
	Users	Subscribed	Registered
Total	16	16	16

Below the overview is a 'New' button. The main table lists the following users:

User	Displayname	IPEI	Handset	Firmware	Sub
5003		00077 0589205	Spectralink 7640	13J	✓
5004		00077 0903259	Spectralink 7620	13L	✓
5006		05003 0008380	Spectralink 7710	14A	✓
5007		05003 0196937	Spectralink Butterfly	13M	✓
5008		00077 0527873	Spectralink 7540	14A	✓
5009		00077 0522224	Spectralink 7540	14A	✓
5010		00077 0845036	KIRK 40XX	13A	✓

2 Click **New**.**Figure 43** Adm. Page WS: Users/List Users/Users page

The screenshot shows the configuration page for 'User 5003'. The form is divided into several sections:

- DECT device:** Model (Spectralink 7640), Software part number (14179920), Firmware (13J), HW version (1), Production Id (0004 8D87 BA78 4324), IPEI (00077 0589205), Access code (empty).
- User:** Standby text (5003), Disabled (checkbox).
- SIP:** Username / Extension * (5003), Domain (empty), Displayname (5003), Authentication user (5003), Authentication password (masked with dots).
- Features:** Call forward unconditional (empty).

Buttons for 'Save', 'Delete', and 'Cancel' are at the bottom. A note indicates that the asterisk (*) denotes a required field.

The data configured for each handset can be split into two categories. DECT data which is necessary for the correct handling of the DECT protocol stack. SIP data which is necessary for the handling of a SIP user agent.

- 3** In the **IPEI** field, type the IPEI number (serial number) of the handset. The serial number consists of a five-digit handset type (manufacturer code) and a seven-digit handset number.
- 4** In the **Access code** field, type the authentication code (AC) (optional)

The authentication code is a subscription password of a maximum of eight digits, defined by the technicians, and can be used when connecting the handset to a Spectralink IP-DECT Server 6500. The authentication code is a subscription pin code for the individual handset.

- 5 In the **Standby text** field, type a text to be displayed when the handset is on hook (optional).
- 6 In the **Username/Extension** field, type the user part of a SIP URI, e.g., 1234 in John Doe<sip:1234@somecompany.com>.
- 7 In the **Domain** field, type the domain part of a SIP URI, e.g. somecompany.com in John Doe<sip:1234@somecompany.com> (optional).
Note: If not configured, the default domain entered under SIP configuration will be used.
- 8 In the **Displayname** field, type the name to be displayed (caller ID), e.g. John Doe in **John Doe**<sip:1234@somecompany.com> (optional).
- 9 In the **Authentication user** field, type a user name (optional).
- 10 The user name will override the **Default User** field under SIP Configuration.
- 11 In the **Authentication password** field, type a password (optional).
The password will override the **Default Password** field under SIP Configuration.
- 12 Click **Save** to save the registration(s).

Retrieving the IPEI Number of the Spectralink Handset

To enable service to the handset, the IPEI number must be programmed into the system database via the web based Administration Page of the Spectralink IP-DECT Server 6500.

The IPEI number of each handset is found either on a label, which is placed behind the battery, or on the packaging label.

To show the serial number on the handset display (74-Handsets), press *99984*, and then press ✓; the serial number appears on the handset display. Press < for 5 seconds to exit the menu.

To show the serial number on the handset display (75/76/77/Butterfly Handset), press Menu, select Status and then select General information to display the IPEI number. Press exit to exit the menu.

Chapter 11: Spectralink Handset Management

This section provides information about handset management such as viewing handset configuration, deregistering handsets and changing user configurations using the web based Administration Page. It also provides information about unsubscribing handsets, exporting/restoring/importing handset registration data and handset adjustment.

Viewing Handset/User Configuration

Through the web based Administration Page, it is possible to view all the user configurations of the wireless system.

- 1 Click **Users**, and then click **List Users**.

Figure 44 Adm. Page WS: Users/List Users page

The screenshot shows the Administration Page for the IP-DECT Server 6500. The navigation bar includes Configuration, Users, Administration, and Firmware. The 'Users' section is active, displaying a 'User List' overview with the following statistics:

User List			
Overview			
System ARI	10046546160 [10 26 b3 1c 00]		
	Users	Subscribed	Registered
Total	16	16	16
<input type="button" value="New"/>			

Displayname	IPEI	Handset	Firmware	Subscription
5003	00077 0589205	Spectralink 7640	13J	✓
5004	00077 0903259	Spectralink 7620	13L	✓
5006	05003 0008380	Spectralink 7710	14A	✓
5007	05003 0196937	Spectralink Butterfly	13M	✓
5008	00077 0527873	Spectralink 7540	14A	✓
5009	00077 0522224	Spectralink 7540	14A	✓

Searching for Handset/User Information

Through the web based Administration Page, it is possible to search for a registered handset/user in the system.

- 1 Click **Users**, and then click **List Users**.

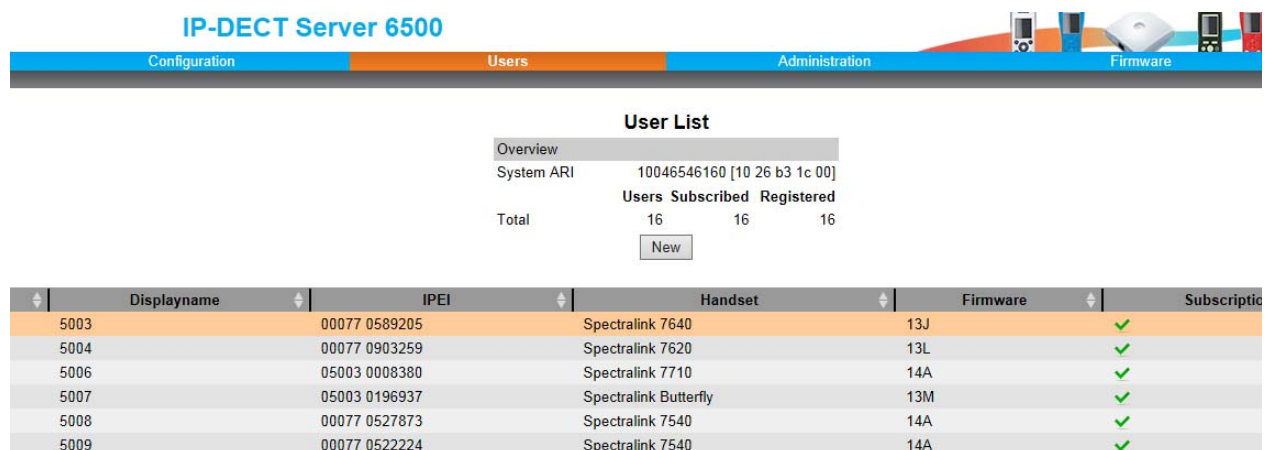
Figure 45 Adm. Page WS: Users/List Users page

The screenshot shows the 'IP-DECT Server 6500' Administration page. The 'Users' tab is selected. The 'User List' overview shows the System ARI as 10046546160 [10 26 b3 1c 00] and a total of 16 users, all of whom are subscribed and registered. A 'New' button is visible below the overview. Below the overview is a table with the following data:

Displayname	IPEI	Handset	Firmware	Subscribed
5003	00077 0589205	Spectralink 7640	13J	✓
5004	00077 0903259	Spectralink 7620	13L	✓
5006	05003 0008380	Spectralink 7710	14A	✓
5007	05003 0196937	Spectralink Butterfly	13M	✓
5008	00077 0527873	Spectralink 7540	14A	✓
5009	00077 0522224	Spectralink 7540	14A	✓

- 2 Type the beginning of a user, display name or IPEI to search for in the text field, and then click **Search**.

Unsubscribing Spectralink Handsets



Note

Removing a subscription requires a password. The default password is: 0000.

Spectralink 74-Handset

To unsubscribe a handset:

- 1 Press **MENU** (☰).
- 2 Press < - go to **MENU LOGIN**.
- 3 Press ✓.
- 4 Press < - go to **SUBSCRIPTION REMOVE**.
- 5 Press ✓.
- 6 Enter password (0000).
- 7 Press ✓.
- 8 If handset is subscribed to more than one system, select the system ARI in question.
The handset has been unsubscribed.

Spectralink 75/76/77/Butterfly Handset

To remove a Login:

Logins can be removed from the system in use and from the 15 other systems (if connected).



Note

Removing a login requires a password. The default password is: 0000.

- 1 Press **Menu** to enter main menu.
- 2 Scroll to **Settings** and press **Select**.
- 3 Scroll to **Advanced** and press **Select**.
- 4 Scroll to **Login** and press **Select**.
- 5 Scroll to **Remove login** and press **Select**.
- 6 Scroll to the desired login and press **Select**.
- 7 Enter your password and press **Ok**.



Note

If the system in use is removed, it is necessary to select one of the remaining systems or to subscribe to a new one.



Note

If one of the systems not chosen is removed, the handset remains connected to the system in use.

Removing Spectralink Handsets from the List (Deregistering)

You can deregister handsets from Spectralink IP-DECT Server 6500. This is necessary when:

- you must replace the handset due to loss or breakage.
- you want to assign the handset to a user with a different telephone number.

- 1 Click **Users**, and then click **List Users**.

Figure 46 Adm. Page WS: Users/List Users page

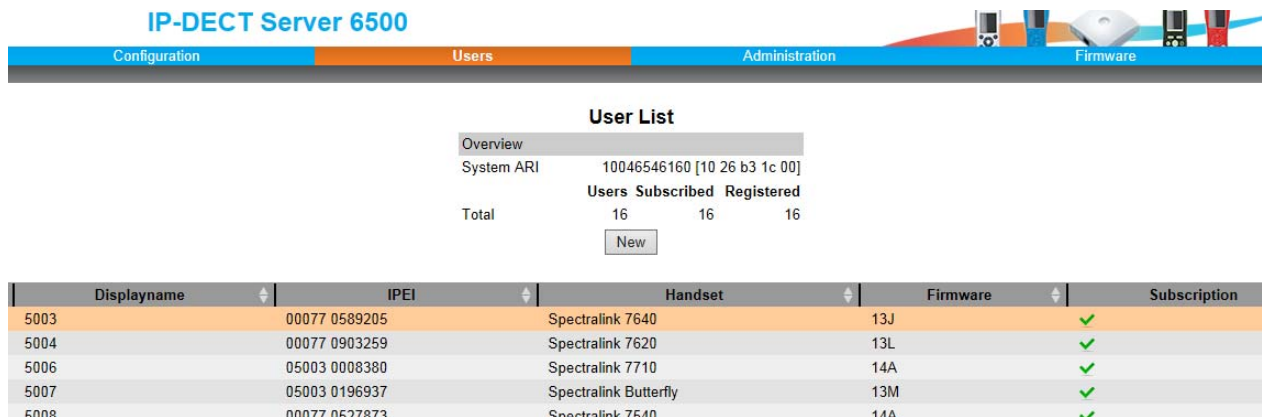

- 2 Type the beginning of a number or name to search for in the text field, and then click **Search** or select the handset in question by clicking on the user information.

The following page appears.

Figure 47 Adm. Page WS: Users/List Users/User page

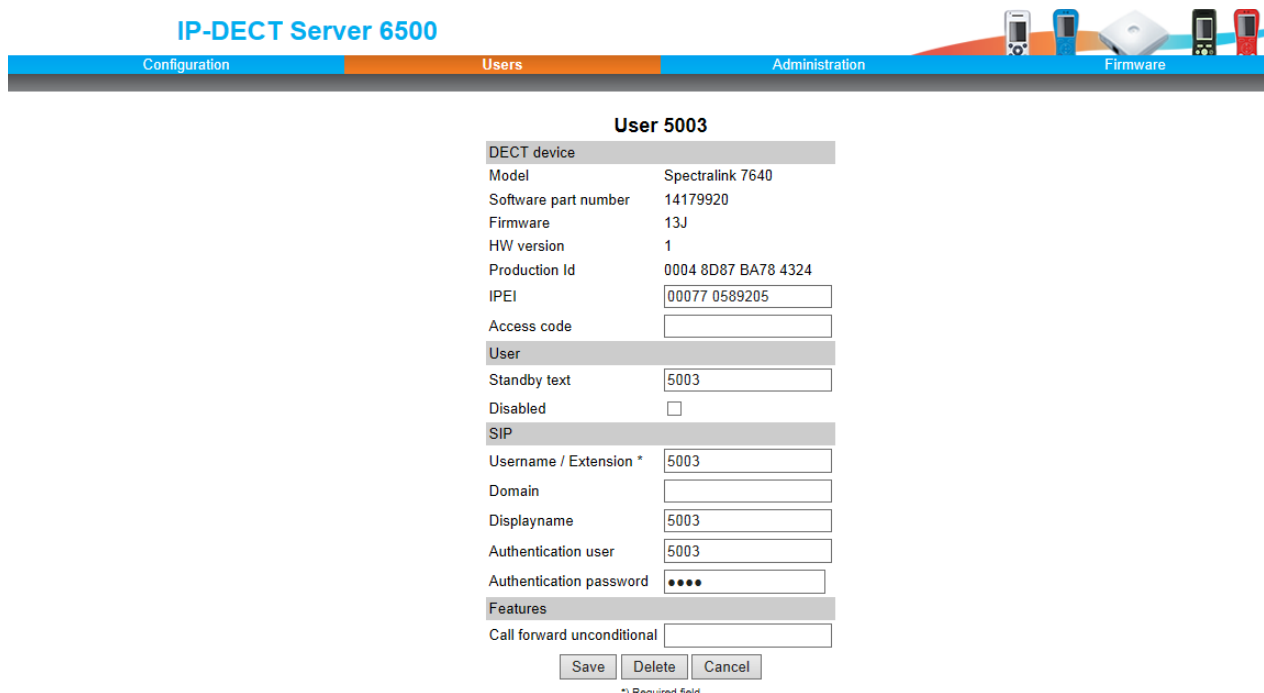

- 3 Click **Delete** to remove the registration.

A warning box appears.

Figure 48 Warning box

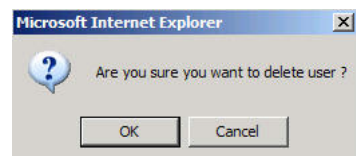

- 4 Click **OK**.

Changing User Configurations

You can change user configurations, such as the AC (authentication code) using the web based Administration Page.

- 1 Click **Users**, and then click **List Users**.

Figure 49 Adm. Page WS: Users/List Users page

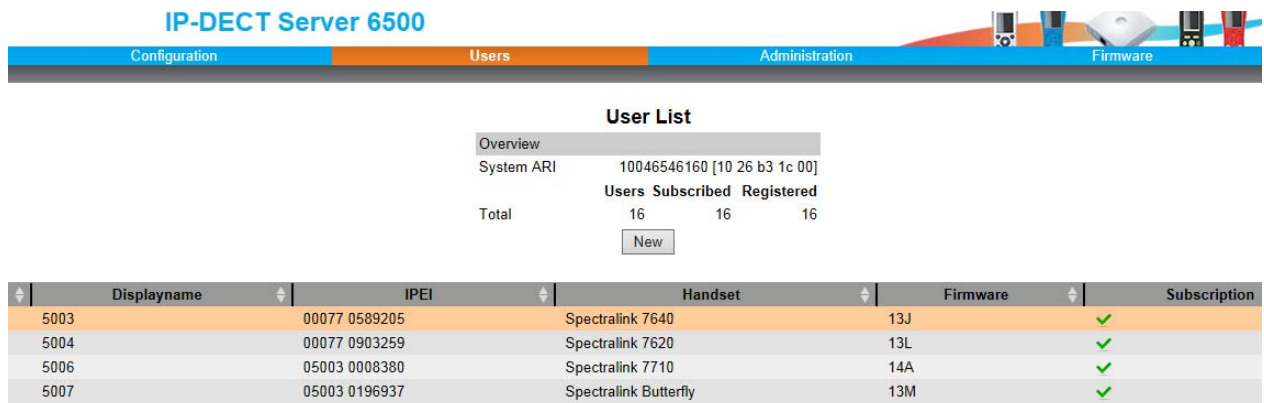

IP-DECT Server 6500

Configuration Users Administration Firmware

User List

Overview

System ARI	10046546160 [10 26 b3 1c 00]		
	Users	Subscribed	Registered
Total	16	16	16

[New](#)

Displayname	IPEI	Handset	Firmware	Subscription
5003	00077 0589205	Spectralink 7640	13J	✓
5004	00077 0903259	Spectralink 7620	13L	✓
5006	05003 0008380	Spectralink 7710	14A	✓
5007	05003 0196937	Spectralink Butterfly	13M	✓

- 2 Type the beginning of a number or name to search for in the text field, and then click **Search** or select the handset in question by clicking on the user information.

The following page appears.

Figure 50 Adm. Page WS: Users/List Users/User page



IP-DECT Server 6500

Configuration Users Administration Firmware

User 5003

DECT device

Model	Spectralink 7640
Software part number	14179920
Firmware	13J
HW version	1
Production Id	0004 8D87 BA78 4324
IPEI	<input type="text" value="00077 0589205"/>
Access code	<input type="text"/>

User

Standby text	<input type="text" value="5003"/>
Disabled	<input type="checkbox"/>

SIP

Username / Extension *	<input type="text" value="5003"/>
Domain	<input type="text"/>
Displayname	<input type="text" value="5003"/>
Authentication user	<input type="text" value="5003"/>
Authentication password	<input type="password" value="••••"/>

Features

Call forward unconditional	<input type="text"/>
----------------------------	----------------------

[Save](#) [Delete](#) [Cancel](#)

*) Required field

- 3 Change settings, and then click **Save**.

Exporting Handset Registration Data

You can export handset registration data using the web based Administration Page. It is possible to export a user database with subscriptions and to export a user database separately from subscriptions (configuration data only).

- 1 Click **Users**, and then click **Import/Export**.

Figure 51 Adm. Page WS: Users/Import/Export page

- 2 Under **Backup User Data** do one of the following:
 - a To save configuration data, click the **Save** button after **User database**.
 - b To save user data with subscriptions, click the **Save** button after **Subscriptions**.
 A **File Download** dialog box appears.

Figure 52 Adm. Page: File Download dialog box.

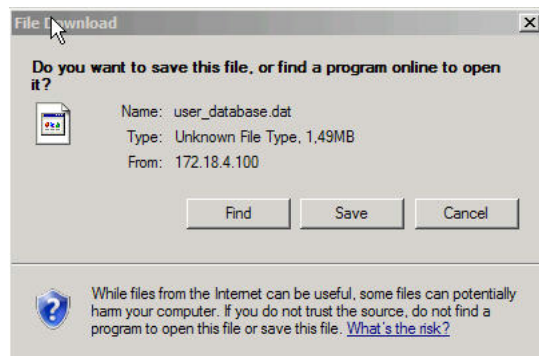

- 3 Click **Save**.
A **Save As** dialog box appears.

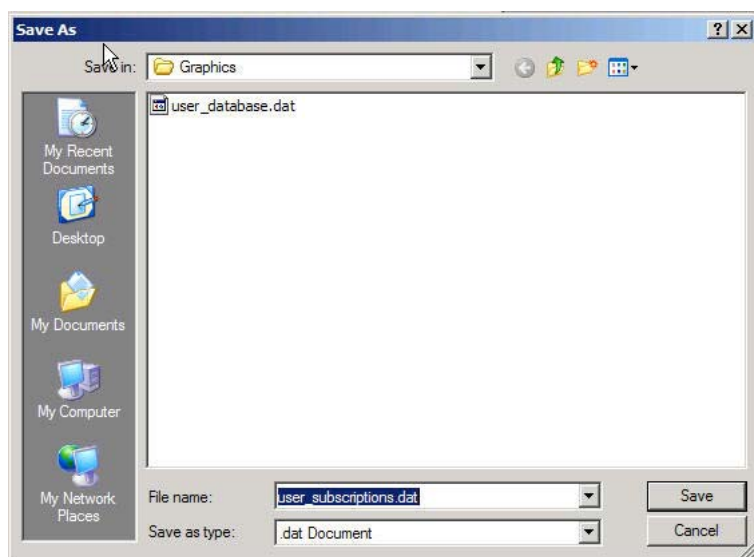
Figure 53 Adm. Page: Save As dialog box

- 4 Indicate in which folder and under what name the file should be saved, and then click **Save**.

Restoring Handset Registration Data

You can restore handset registration data using the web based Administration Page. It is possible to restore a user database with subscriptions and to restore a user database separately from subscriptions (configuration data only).

- 1 Click **Users**, and then click **Import/Export**.

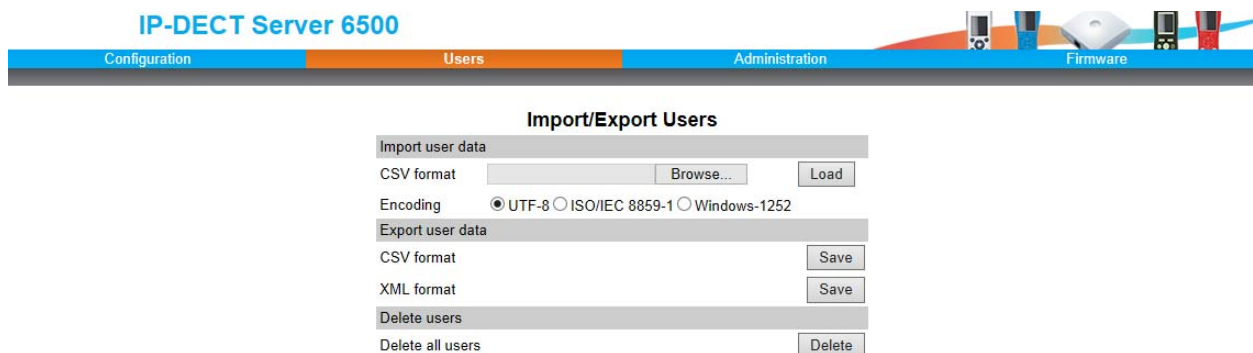
Figure 54 Adm. Page WS: Users/Import/Export page

- 2 Under **Restore User Data** do one of the following:
 - a To restore configuration data, click the **Browse** button after **User database**.
 - b To restore user data with subscriptions, click the **Browse** button after **Subscriptions**.
A **Choose File** dialog box appears.

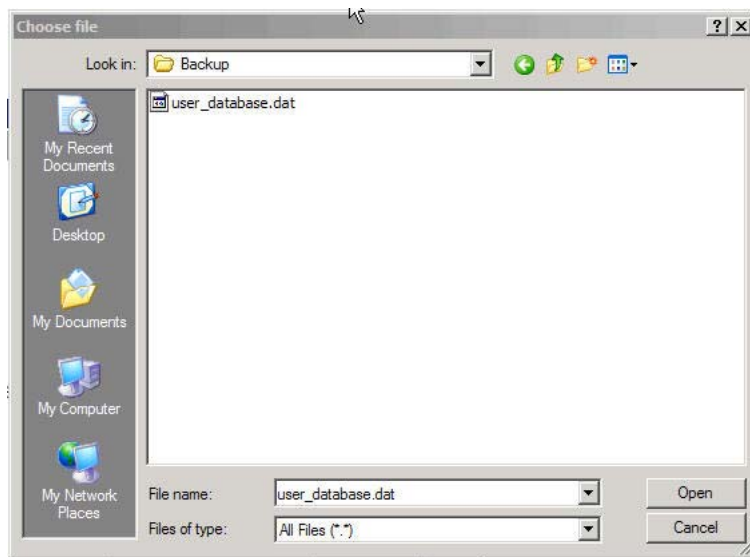
Figure 55 Adm. Page: Choose File dialog box

3 Select the file in question, and then click **Open**.

4 Click **Load**.

The following page appears.

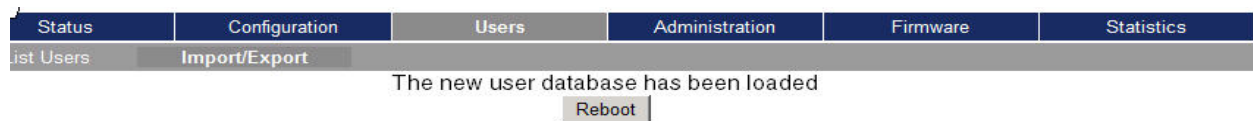
Figure 56 Adm. Page WS: Users/Import/Export/Loaded page

5 Click **Reboot**. A warning message appears.

Figure 57 Adm. Page: Reboot Warning message

6 Click **OK**.

The system is rebooted. This can take a few minutes.

Importing Handset Registration Data - CSV Format

You can import handset registration data in CSV format. To be able to import the data correctly, you must create a file containing the following information and punctuation:

#IPEI,access code,standby text,username,domain,displayname,authenticate user,authenticate password,local number



Note

If you want to leave out some of the information, e.g. standby text, you must keep the commas, e.g.:#IPEI,access code,,username,domain,displayname,authenticate user,authenticate password,local number.

Figure 58 Example of Handset Registration Data in CSV Format

	A	B	C	D	E	F	G	H	I	J	K	L	M	N
1	#IPEI,	access code,	standby text,	username,	domain,	displayname,	authenticate	user,	authenticate	password,	local number			
2	000770000100,	IP6000,	2631,	RFP Test,	2631,	2631								
3	000770000101,	IP6000,	2632,	RFP Test,	2632,	2632								
4	000770000102,	IP6000,	2633,	RFP Test,	2633,	2633								
5	000770000103,	IP6000,	2634,	RFP Test,	2634,	2634								
6	000770000104,	IP6000,	2635,	RFP Test,	2635,	2635								
7	000770000105,	IP6000,	2636,	RFP Test,	2636,	2636								
8	000770000106,	IP6000,	2637,	RFP Test,	2637,	2637								

1 Click **Users**, and then click **Import/Export**.

Figure 59 Adm. Page WS: Users/Import/Export page

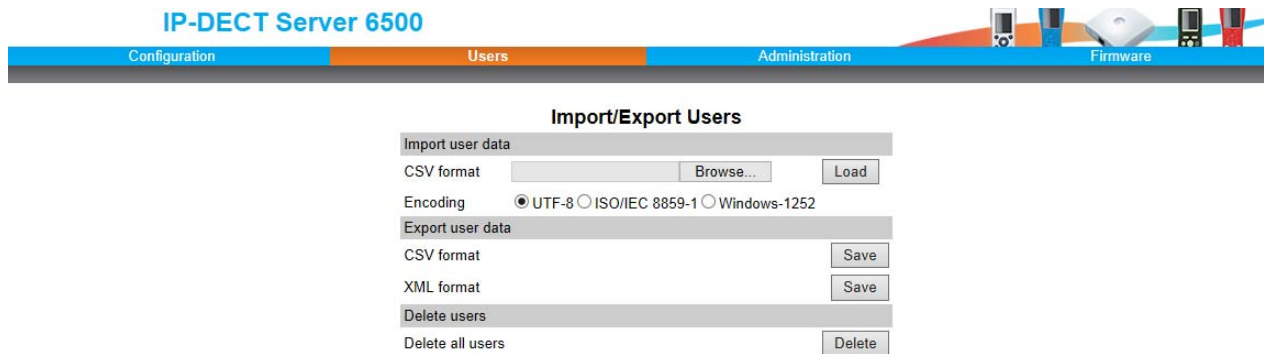

2 Under **Import User Data**, click **Browse** to find the CSV file with handset registration data. A **Choose File** dialog box appears.

Figure 60 Adm. Page: Choose File dialog box

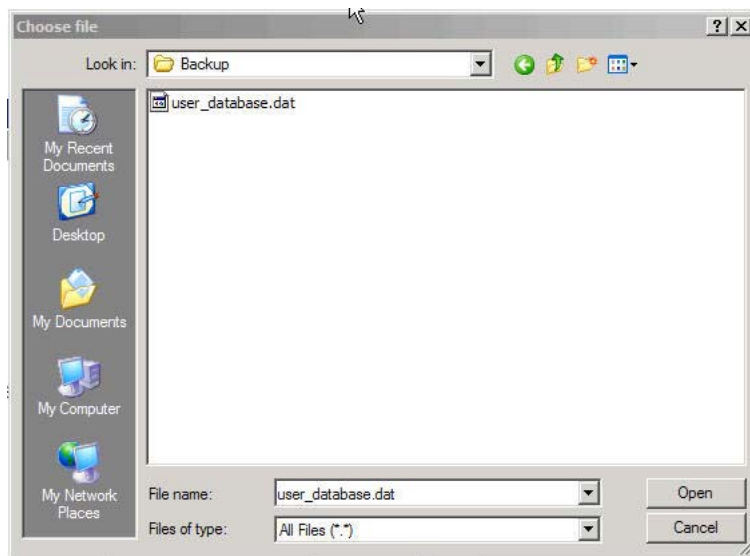

- 3 Select the file in question, and then click **Open**.
- 4 Click **Load**.
- 5 Click **OK**.



Note

It is not possible to import handset registration data already registered in the system.

Chapter 12: System Management

This section provides you with information about the web based Administration Page of the Spectralink IP-DECT Server 6500.

Through the web based Administration Page of the Spectralink IP-DECT Server 6500 it is possible to define and view different settings of the system, reading statistics, making a backup of configuration file, updating system software, and resetting the system.

Spectralink IP-DECT Server 6500

Changing System User Name and Password



Note

It is not possible to import handset registration data already registered in the system.

From the Administration Page it is possible to change the user name and password for the system.

- 1 Click **Configuration**, and then click **Security**.

Figure 61 Adm. Page WS: Configuration/Security page

The screenshot shows the web-based administration interface for the IP-DECT Server 6500. The page title is "IP-DECT Server 6500". The navigation menu includes: Configuration (Security, Certificates, SIP, Lync), Users, Provisioning, Redundancy, Import/Export, Administration, and Firmware. The "Security Configuration" section is active and contains the following fields and options:

- Administrator Authentication:**
 - Current password *
 - New username * (value: admin)
 - New password
 - New password again
- Remote Access:**
 - Force secure HTTP (TLS)
 - Allow remote logging

Buttons: Save, Cancel
*) Required field **) Require restart

- 2 In the **Current password** field, type the current password.
- 3 In the **New user name** field, type a user name.
- 4 In the **New password** field, type a new password
- 5 In the **New password again** field, type the new password again to confirm it.
- 6 Click **Save** to change the password.

Reading System Information

Under **Status** it is possible to get general information about hardware version, firmware and message logging. This information is useful in case of problem solving. Accessing the Administration Page of the wireless server provides an overview of the solution.

General Status Information

This page provides general system information such as hardware, firmware and OS Status information.

- 1 Click **Status**, and then click **General**.

Figure 62 Adm. Page Wireless Server: Status/General page

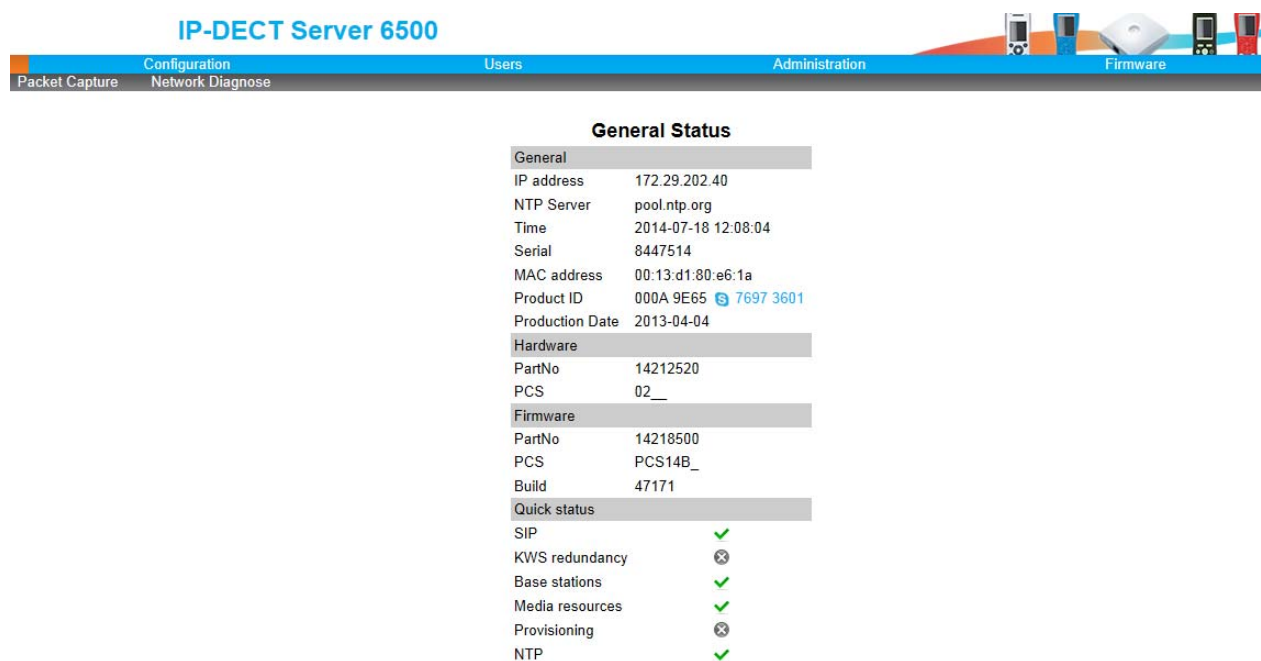

IP-DECT Server 6500

Configuration | Users | Administration | Firmware

Packet Capture | Network Diagnose

General Status

General	
IP address	172.29.202.40
NTP Server	pool.ntp.org
Time	2014-07-18 12:08:04
Serial	8447514
MAC address	00:13:d1:80:e6:1a
Product ID	000A 9E65 7697 3601
Production Date	2013-04-04
Hardware	
PartNo	14212520
PCS	02_
Firmware	
PartNo	14218500
PCS	PCS14B_
Build	47171
Quick status	
SIP	✓
KWS redundancy	✗
Base stations	✓
Media resources	✓
Provisioning	✗
NTP	✓

On the Status/General page the following information is available.

- General
- IP-address: current IP address of device
- NTP-Server: address of time server
- Time: current time on device
- Serial: Serial number of device
- MAC address: of device
- Product ID: from device
- Production Date: of device
- Hardware
- PartNoof hardware

- PCSHardware version of device_
- Firmware
- PartNosoftware part number
- PCSSoftware version
- BuildSoftware build number
-
- Quick status Red/Green/Grey
- SIPQuick status
- Base stationsQuick status
- Media resources Quick status
- ProvisioningQuick status
- NTPQuick status

Logs Information

This page provides log information such as media resource connection, base station connection and different types of status.

- 1 Click **Status**, and then click **Logs**.

Figure 63 Adm. Page WS: Status/Logs page

Type	Message
notice	KGAP 1.23.0 (47171) started
notice	Configured as a single node
notice	KGAP Admin 1.23.0 (47171) started
notice	MediaResource 1.19.0 47171 started
notice	msfphonebook started

- 2 From the **Display filter** list you can select between **emergency**, **critical**, **error**, **warning**, **notice** or **info** depending on the logs you want to see.

The different types of status are:

- emergency (errors causing the system to malfunction for all calls)
- critical (events that do not occur under normal operation, cause minor malfunction)
- error (events that do not occur under normal operation, cause minor malfunction)
- warning (events that do not occur under normal operation, may cause malfunction)
- notice info (events that occur under normal operation, relevant to an

- 3 Click **Save** if you want to save the logs in a file.

A **Save As** dialog box appears.

Figure 64 Adm. Page: Save As dialog box

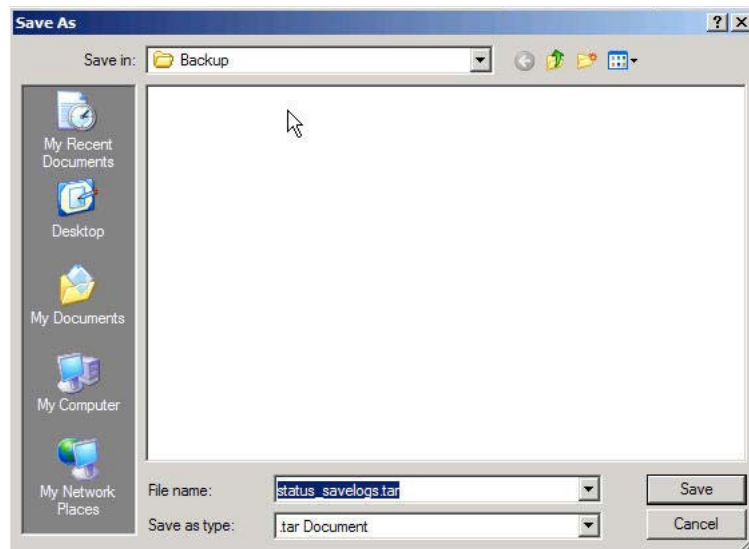

- 4 Indicate in which folder and under what name the file should be saved, and then click **Save**.
It is now possible to send the log files to authorized technicians for further support and problem solving.

Wireless Server Information

This page provides information about the firmware version and ARI code of the Spectralink IP-DECT Server 6500.

- 1 Click **Status**, and then click **Wireless Server**.

Figure 65 Adm. Page Wireless Server: Status/Wireless Server page

IP-DECT Server 6500

Configuration Users Administration Firmware

Packet Capture Network Diagnose

Wireless Server Status	
General	
Firmware version	47171
ARI	10046546160 [10 26 b3 1c 00]
License information	
License max users	180
License features	Basic service, Frequency swap, Redundancy, Lync, Security
Service Status	
Wireless Server Uptime	0d 3h 59m 15s
Call establishment	Allowed
Subscription	Allowed

Reading Statistics

Under **Statistics**, it is possible to read statistic information about the Spectralink IP-DECT Server 6500, media resource, base station, and calls, handovers and abnormal releases in the system. You get an over all overview of how the system is running.

Wireless Server

This page is useful to get information about traffic on the Spectralink IP-DECT Server 6500 such as voice call traffic and message call traffic and it provides a summary of subscription and handover statistics. It also provides information about the traffic load (Erlang) of the installation which is useful when determining the number of media resources needed.

- 1 Click **Statistics**, and then click **Wireless Server**.

Figure 66 Adm. Page Wireless Server: Statistics/Wireless Server page

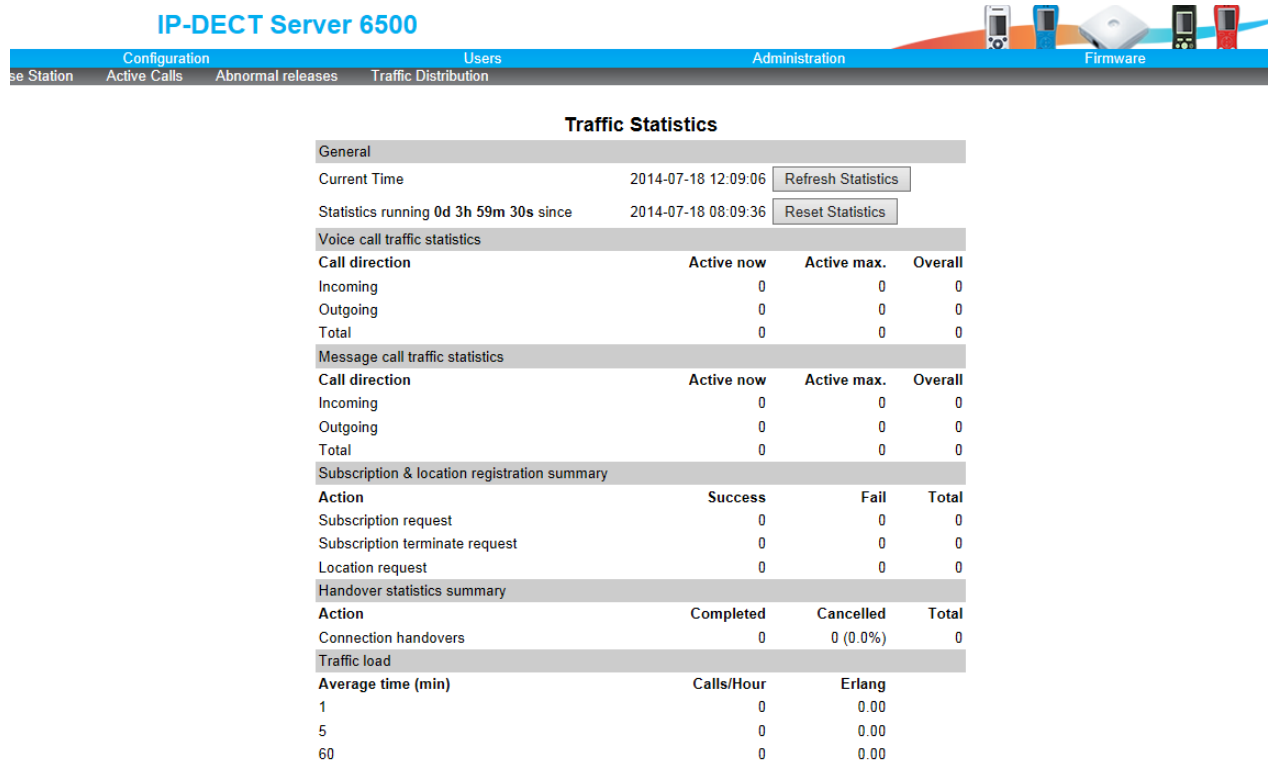

- 2 Click **Reset Statistics** if you want to delete all statistic traffic information.
A warning message appears.

Figure 67 Warning message

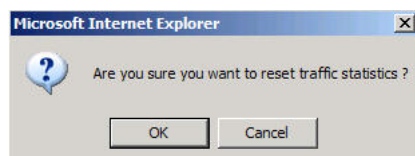

- 3 Click **OK**.

Media Resource

This page is useful to get information about the media resource.

- 1 Click **Statistics**, and then click **Media Resource**.

Figure 68 Adm. Page Wireless Server: Statistics/Media Resource page



Base Station

This page is useful to get statistic information about the base station.

- 1 Click **Statistics**, and then click **Base Station**.

Figure 69 Adm. Page Wireless Server: Statistics/Base Station page

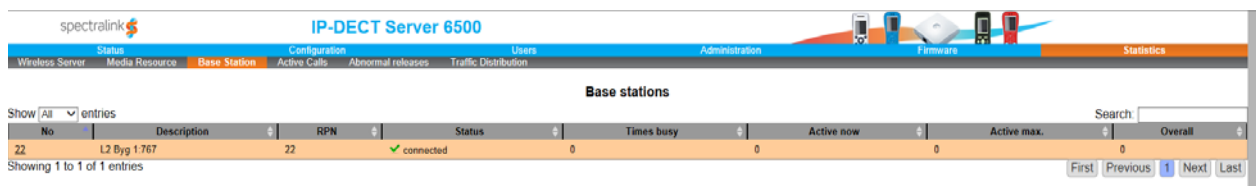

Active Calls

This page is useful to get statistic information about active calls in the Spectralink IP-DECT Server 6500 installation.

- 1 Click **Statistics**, and then click **Active Calls**.

Figure 70 Adm. Page Wireless Server: Statistics/Active Calls page

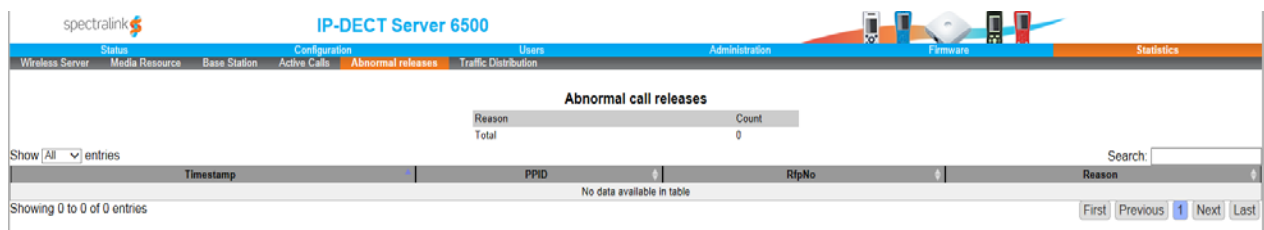

Abnormal Releases

This page is useful to get statistic information about abnormal releases in a Spectralink IP-DECT Server 6500 installation.

- 1 Click **Statistics**, and then click **Abnormal Releases**.

Figure 71 Adm. Page Wireless Server: Statistics/Abnormal Releases page

The screenshot shows the 'Abnormal call releases' page. At the top, there's a navigation bar with 'IP-DECT Server 6500' and tabs for 'Status', 'Configuration', 'Users', 'Administration', and 'Statistics'. Below this, there's a sub-navigation bar with 'Wireless Server', 'Media Resource', 'Base Station', 'Active Calls', 'Abnormal releases', and 'Traffic Distribution'. The 'Abnormal releases' tab is active. The main content area has a table with columns 'Reason' and 'Count'. The 'Total' row shows a count of 0. There's a search bar on the right and pagination controls at the bottom right.

Traffic Distribution

This page is useful to get statistic information about traffic distribution during the last 24 hours in a Spectralink IP-DECT Server 6500 installation.

- 1 Click **Statistics**, and then click **Traffic Distribution**.

Figure 72 Adm. Page Wireless Server: Statistics/Traffic Distribution page

The screenshot shows the 'Traffic Distribution' page. At the top, there's a navigation bar with 'IP-DECT Server 6500' and tabs for 'Status', 'Configuration', 'Users', 'Administration', and 'Statistics'. Below this, there's a sub-navigation bar with 'Wireless Server', 'Media Resource', 'Base Station', 'Active Calls', 'Abnormal releases', and 'Traffic Distribution'. The 'Traffic Distribution' tab is active. The main content area has a table with columns: 'Time', 'Voice calls', 'Abnormal releases', 'MSF calls', 'Voice calls total', 'Abnormal releases total', and 'MSF calls total'. The table shows data for time intervals from 00-01 to 05-06, with all values being 0. There's a search bar on the right and pagination controls at the bottom right.

Making a Back-Up of the Configuration File

This section provides information about saving the configuration data of the Spectralink IP-DECT Server 6500, registration and subscription data of the handset and system information.

When saving the configuration data you have an overall overview of the Spectralink Wireless Server which is useful in case of problem solving.

- 1 Click **Administration**, and then click **Backup**.

Figure 73 Adm. Page Wireless Server: Configuration/Backup/Restore page

The screenshot shows the 'System Backup' page. At the top, there's a navigation bar with 'IP-DECT Server 6500' and tabs for 'Configuration', 'Users', 'Administration', and 'Firmware'. Below this, there's a sub-navigation bar with 'Resource', 'Base Station', 'Clusters', 'Phonebook', and 'Backup'. The 'Backup' tab is active. The main content area has a 'System Backup' section. It has a 'Backup' section with a 'Full system backup' button and a 'Save' button. There's also a 'Restore' section with a 'Full system restore **' field, a 'Browse...' button, and a 'Restore' button. A note at the bottom says '* Required field ** Require restart'.

- 2 Click **Save**.

A **File Download** dialog box appears.

Figure 74 File Download dialog box

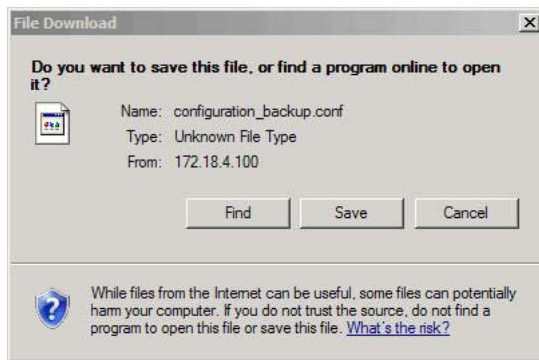

3 Click **Save**.

A **Save As** dialog box appears.

Figure 75 Save As dialog box

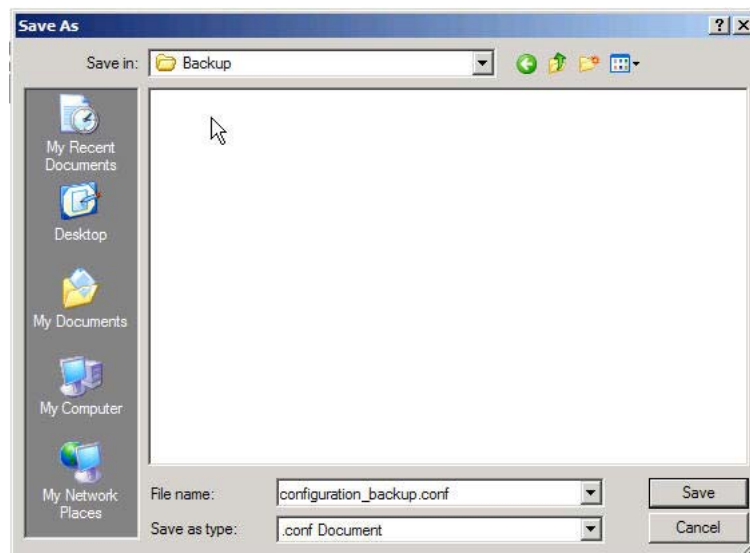

4 Indicate in which folder and under what name the file should be saved, and then click **Save**.

Restoring Configuration File

This section describes how to restore a configuration file.

1 Click **Configuration**, and then click **Backup/Restore**.

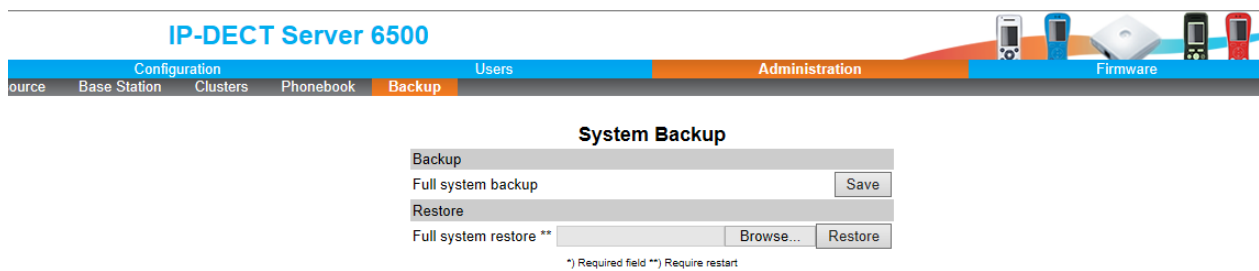
Figure 76 Adm. Page Wireless Server: Configuration/Backup/Restore page**2 Click Browse.**

A **Choose File** dialog box appears.

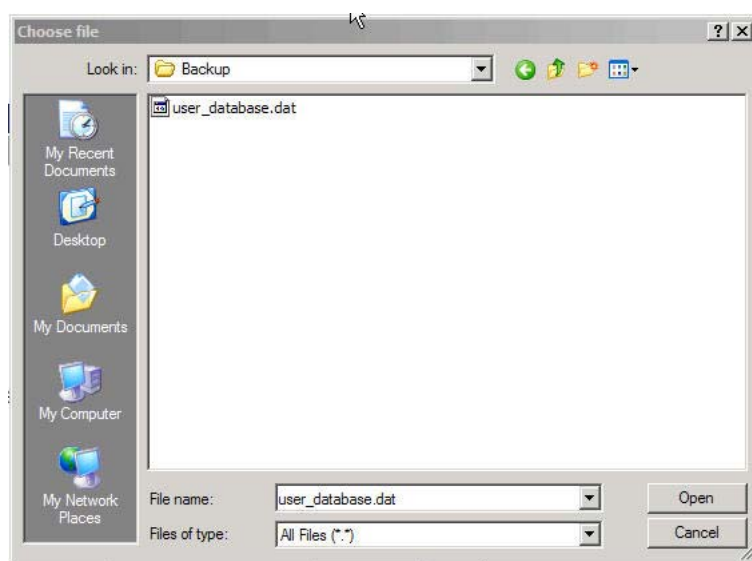
Figure 77 Adm. Page: Choose File dialog box**3 Select the file in question, and then click Open.****4 Click Load.****5 Click OK.**

The configuration file is restored in the system.

Updating the Spectralink IP-DECT Server 6500

The software of the Spectralink IP-DECT Server 6500 can be updated. To update the software you load a file to the system. Contact your distributor for newest software.

Updating Spectralink IP-DECT Server 6500 Firmware

1 Click Firmware, and then click Server.

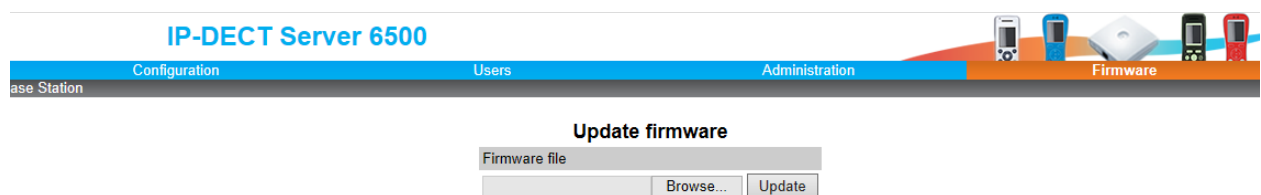
Figure 78 Adm. Page Wireless Server: Firmware/Wireless Server page

2 Click **Browse**.

A **Choose File** dialog box appears.

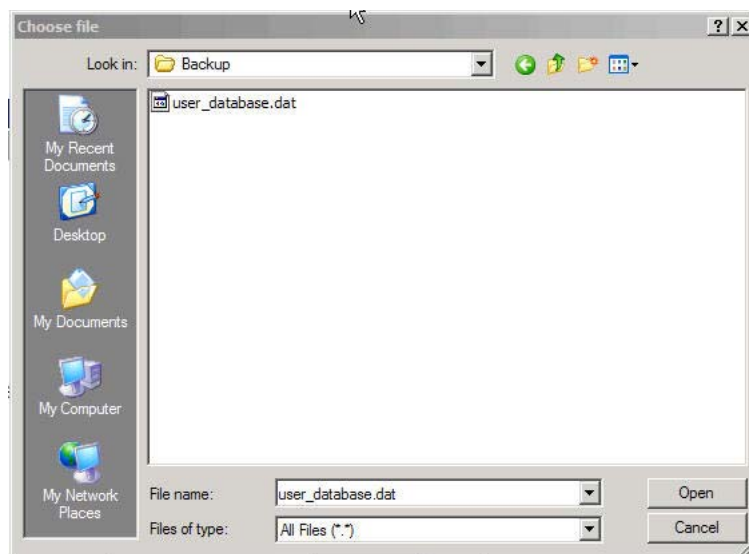
Figure 79 Adm. Page: Choose File dialog box

3 Select the file in question, and then click **Open**.

4 Click **Update**.

Wait until the system has finished updating.

Warning: Do not cut power.

Figure 80 Adm. Page: Firmware Update Progress Bar

5 Optionally, you can block new calls during a firmware update by clicking **Administration**, and then **Server**.

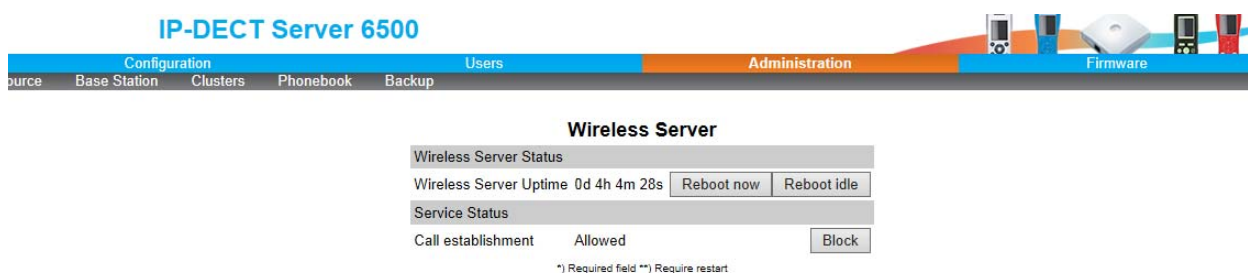
Figure 81 Adm. Page Server: Administration/Wireless Server page

Under **Service Status** click **Block**.

12.0.0.1 Click **Update** to update the Spectralink IP-DECT Server 6500 firmware. The system prompts for a restart, when the firmware update is complete.

- 6 If you have blocked new calls during a firmware update, enable new calls again by clicking **Administration**, then **Server** and then clicking **Allow**.

Restarting the Spectralink IP-DECT Server 6500

Some configuration changes requires a restart in order to take effect. A reset restarts the Spectralink IP-DECT Server 6500 software.



Note

Changes that require a restart are marked by 2 stars **.

You must restart the system after the following procedures:

- Configuration
- Uploading of configuration data
- Uploading of firmware

Operating System of Spectralink IP-DECT Server 6500

When restarting the operating system of the Spectralink IP-DECT Server 6500 all calls are terminated and the Spectralink IP-DECT Server 6500 is reset.

- 1 Click **Administration**, and then click **Server**.

Figure 82 Adm. Page Wireless Server: Administration/Wireless Server page

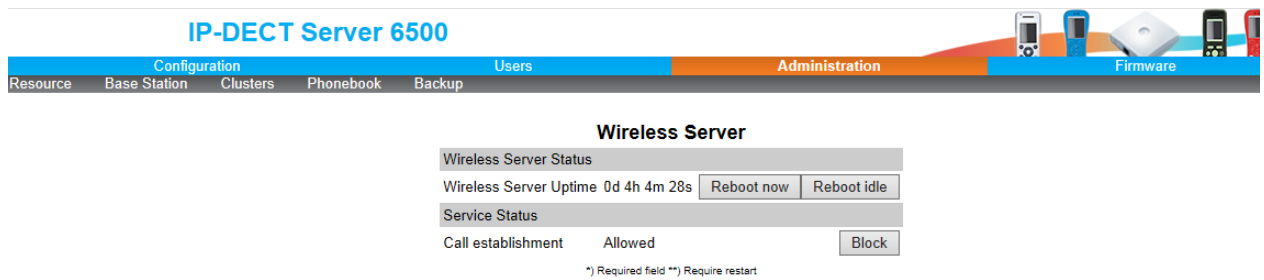

2 After **Wireless Server Uptime** click **Reboot now** or **Reboot idle** (when active calls have ended).

A warning box appears.

Figure 83 Warning box



3 Click **OK**.

Spectralink Media Resources

Changing System User Name and Password

From the Administration Page it is possible to change the user name and password for the system.

1 Click **Configuration**, and then click **Security**.

Figure 84 Adm. Page Media Resource: Configuration/Security page

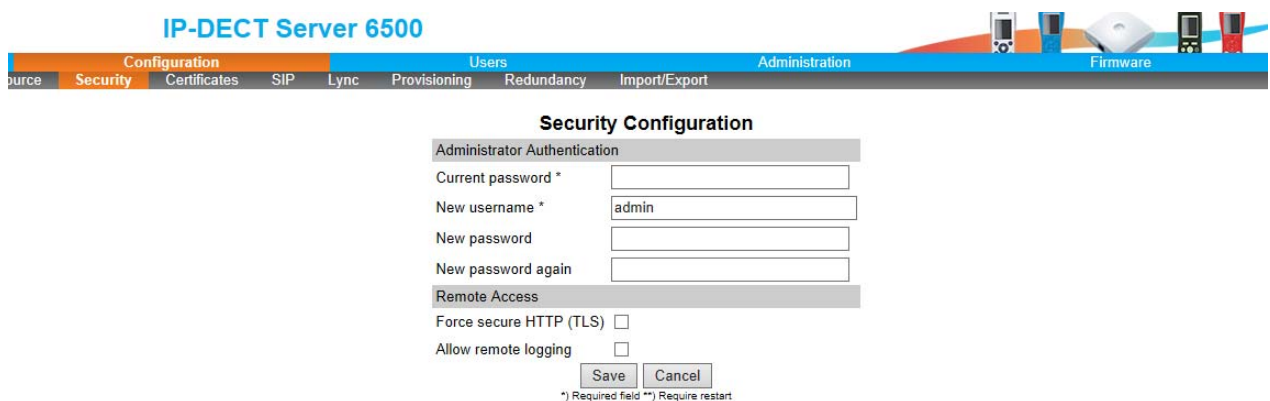

- 2 In the **Current password** field, type the current password.
- 3 In the **New user name** field, type a user name.
- 4 In the **New password** field, type a new password
- 5 In the **New password again** field, type the new password again to confirm it.
- 6 Click **Save** to change the password.

Reading System Information

Under **Status** it is possible to get general information about hardware version, firmware and message logging. This information is useful in case of problem solving.

General Status Information

This page provides general system information such as hardware, firmware and OS Status information.

- 1 Click **Status**, and then click **General**.

Figure 85 Adm. Page Media Resource: Status/General page

General Status	
General	
IP address	172.29.202.40
NTP Server	pool.ntp.org
Time	2014-07-18 12:15:27
Serial	8447514
MAC address	00:13:d1:80:e6:1a
Product ID	000A 9E65 7697 3601
Production Date	2013-04-04
Hardware	
PartNo	14212520
PCS	02_
Firmware	
PartNo	14218500
PCS	PCS14B_
Build	47171
Quick status	
SIP	✓
KWS redundancy	⊗
Base stations	✓
Media resources	✓
Provisioning	⊗
NTP	✓

On the Status/General page the following information is available.

- General
- IP-address: current IP address of device
- NTP-Server: address of time server
- Time: current time on device
- Serial: Serial number of device

- MAC address: of device
- Product ID: from device
- Production Date: of device
- Hardware
- PartNoof hardware
- PCSHardware version of device_
- Firmware
- PartNosoftware part number
- PCSSoftware version
- BuildSoftware build number
- Quick status Red/Green/Grey
- SIPQuick status
- Base stationsQuick status
- Media resources Quick status
- ProvisioningQuick status
- NTPQuick status

Logs Information

This page provides logs information such as media resource connection, base station connection and different types of status.

Figure 86 Adm. Page Media Resource: Status/Logs page

IP-DECT Server 6500

Configuration Users Administration Firmware

Packet Capture Network Diagnose Firmware

Message Log

Display filter:

amp	Type	Message
	notice	KGAP 1.23.0 (47171) started
	notice	Configured as a single node
	notice	KGAP Admin 1.23.0 (47171) started
	notice	MediaResource 1.19.0 47171 started

- 1 From the **Display filter** list you can select between **emergency**, **critical**, **error**, **warning**, **notice**, **info** or **debug** depending on the logs you want to see.

The different types of status are:

- emergency (errors causing the system to malfunction for all calls)
- critical (events that do not occur under normal operation, cause minor malfunction)
- error (events that do not occur under normal operation, cause minor malfunction)

- warning (events that do not occur under normal operation, may cause malfunction)
 - notice info (events that occur under normal operation, relevant to an administrator)
- 2 Click **Status**, and then click **Logs**.
 - 3 Click **Save** if you want to save the logs in a file.
A **Save As** dialog box appears.

Figure 87 Adm. Page: Save As dialog box

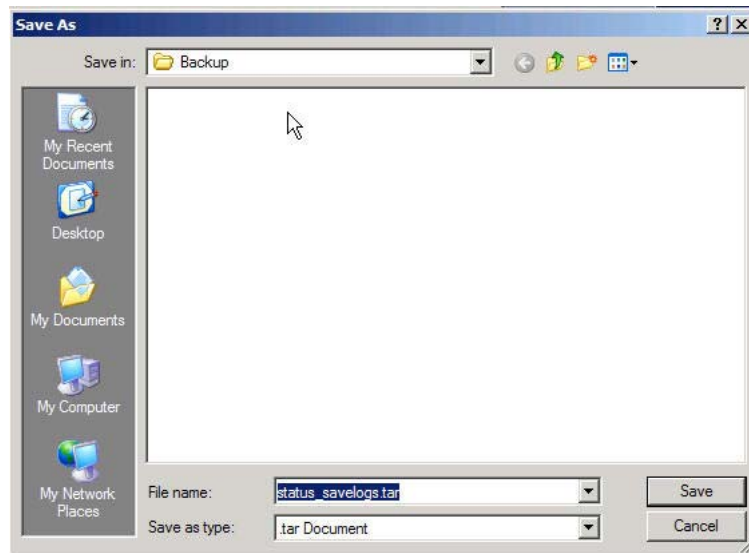

- 4 Indicate in which folder and under what name the file should be saved, and then click **Save**.
It is now possible to send the log files to authorized technicians for further support and problem solving.

Reading Statistics

Statistic information about the media resource is retrieved from the Administration Page of the Spectralink IP-DECT Server 6500.

Updating the Spectralink Media Resource Firmware

The software of the media resource can be updated. To update the software you load a file to the system. Contact your distributor for newest software.



Note

You can upload software directly from the Spectralink Wireless server under Firmware/Wireless Server, Media Resource, Base Station..

Updating Spectralink Media Resource Firmware

- 1 Click **Firmware**, and then click **Media Resource**.

Figure 88 Adm. Page Media Resource: Firmware/Media Resource page

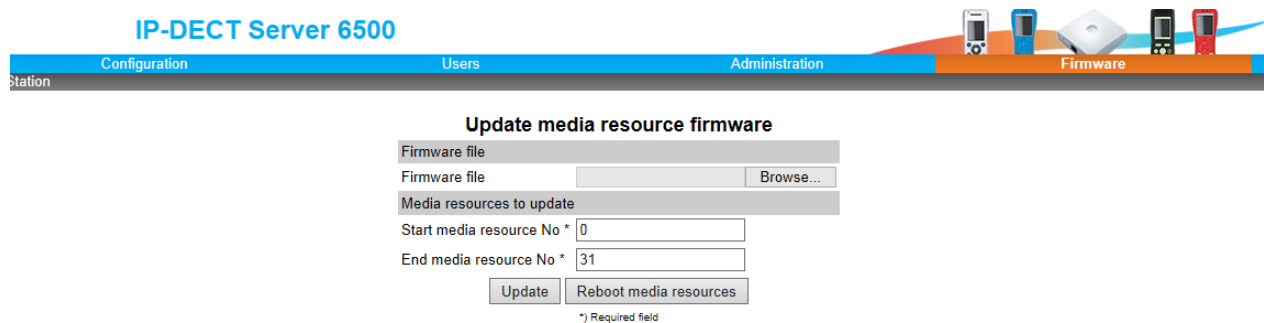

- 2 Click **Browse**.

A **Choose File** dialog box appears.

Figure 89 Adm. Page: Choose File dialog box

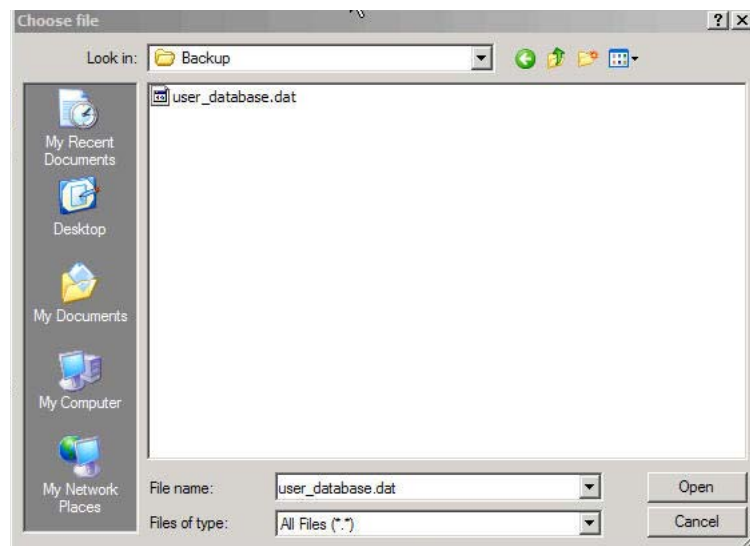

- 3 Select the file in question, and then click **Open**.

The file to select has the extension **.bin**.

- 4 Click **Update**.

Wait until the system has finished uploading.

Figure 90 Adm. Page: Firmware Update Progress Bar

- Optionally, you can block new calls during a firmware update by clicking **Administration** (Administration Page of Spectralink IP-DECT Server 6500), and then **Wireless Server**.

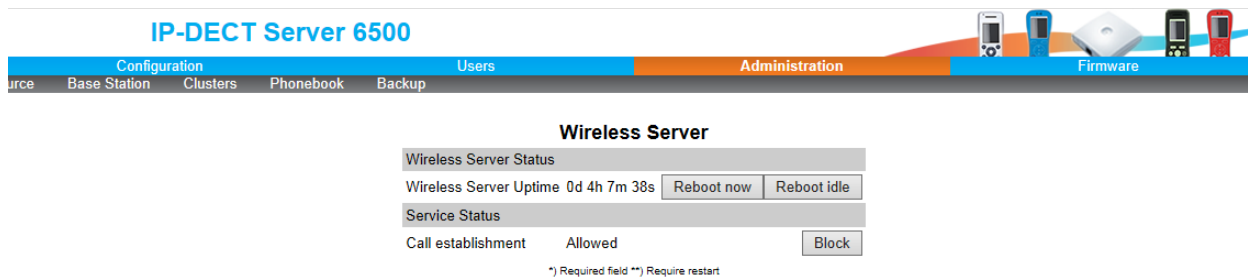
Figure 91 Adm. Page Wireless Server: Administration/Wireless Server page

Under **Service Status** click **Block**.

- When the update is finished, click **Reboot** to execute the changes.
- If you have blocked new calls during a firmware update, enable new calls again by clicking **Administration** (Administration Page of Spectralink IP-DECT Server 6500), then **Server** and then clicking **Allow**.

Spectralink IP-DECT Base Station

Changing System User Name and Password

From the Administration Page it is possible to change the user name and password for the system.

- Click **Configuration**, and then click **Security**.

Figure 92 Adm. Page Base Station: Configuration/Security page

The screenshot shows the 'IP-DECT Server 6500' Administration interface. The top navigation bar includes 'Configuration', 'Users', 'Administration', and 'Firmware'. The 'Configuration' section is expanded to show 'Security', 'Certificates', 'SIP', 'Lync', 'Provisioning', 'Redundancy', and 'Import/Export'. The 'Security Configuration' page is displayed, featuring two main sections: 'Administrator Authentication' and 'Remote Access'. The 'Administrator Authentication' section contains four text input fields: 'Current password *', 'New username *' (with 'admin' entered), 'New password', and 'New password again'. The 'Remote Access' section contains two checkboxes: 'Force secure HTTP (TLS)' and 'Allow remote logging', both of which are unchecked. At the bottom of the form are 'Save' and 'Cancel' buttons, and a note: '* Required field ** Require restart'.

- 2 In the **Current password** field, type the current password.
- 3 In the **New user name** field, type a user name.
- 4 In the **New password** field, type a new password
- 5 In the **New password again** field, type the new password again to confirm it.
- 6 Click **Save** to change the password.

Reading System Information

Under **Status** it is possible to get general information about hardware version, firmware and message logging. This information is useful in case of problem solving.

General Status Information

This page provides general system information such as hardware, firmware and OS Status information.

- 1 Click **Status**, and then click **General**.

Figure 93 Adm. Page Base Station: Status/General page

IP-DECT Server 6500

Configuration Administration Users Network Diagnose

General Status

General	
IP address	172.29.202.40
NTP Server	pool.ntp.org
Time	2014-07-18 12:22:34
Serial	8447514
MAC address	00:13:d1:80:e6:1a
Product ID	000A 9E65 7697 3601
Production Date	2013-04-04
Hardware	
PartNo	14212520
PCS	02__
Firmware	
PartNo	14218500
PCS	PCS14B_
Build	47171
Quick status	
SIP	✓
KWS redundancy	✗
Base stations	✓
Media resources	✓
Provisioning	✗
NTP	✓

On the Status/General page the following information is available.

- General
- IP-address: current IP address of device
- NTP-Server: address of time server
- Time: current time on device
- Serial: Serial number of device
- MAC address: of device
- Product ID: from device
- Production Date: of device
- Hardware
- PartNoof hardware
- PCSHardware version of device_
- Firmware
- PartNosoftware part number
- PCSSoftware version
- BuildSoftware build number
-
- Quick status Red/Green/Grey
- SIPQuick status

- Base stations Quick status
- Media resources Quick status
- Provisioning Quick status
- NTP Quick status

Logs Information

This page provides logs information such as media resource connection, base station connection and different types of status.

The different types of status are:

- emergency (errors causing the system to malfunction for all calls)
- critical (events that do not occur under normal operation, cause minor malfunction)
- error (events that do not occur under normal operation, cause minor malfunction)
- warning (events that do not occur under normal operation, may cause malfunction)
- notice info (events that occur under normal operation, relevant to an administrator)

- 1 Click **Status**, and then click **Logs**.

Figure 94 Adm. Page Base Station: Status/Logs page

mp	Type	Message
	notice	KGAP 1.23.0 (47171) started
	notice	Configured as a single node
	notice	KGAP Admin 1.23.0 (47171) started
	notice	MediaResource 1.19.0 47171 started

- 2 From the **Display filter** list you can select between **emergency**, **critical**, **error**, **warning**, **notice** or **info** depending on the logs you want to see.
- 3 Click **Save** if you want to save the logs in a file.
A **Save As** dialog box appears.

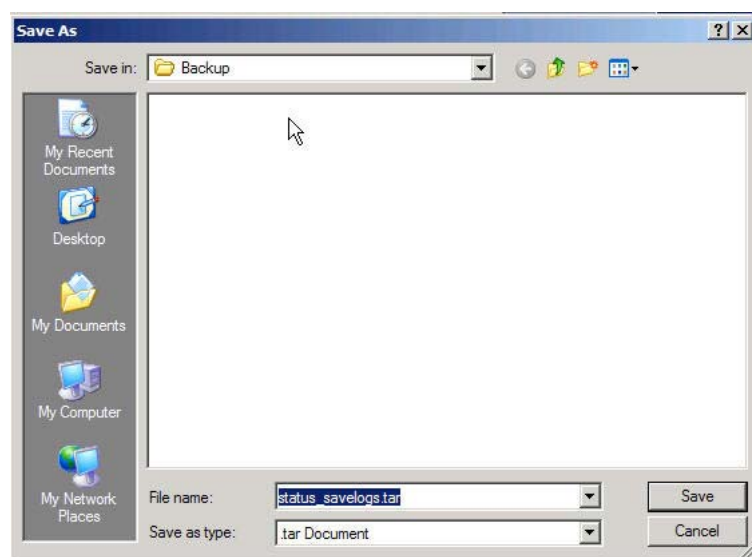
Figure 95 Adm. Page: Save As dialog box

- 4 Indicate in which folder and under what name the file should be saved, and then click **Save**.

It is now possible to send the log files to authorized technicians for further support and problem solving.

Reading Statistics

Statistic information about the base station is retrieved from the Administration Page of the Spectralink IP-DECT Server 6500.

Sync State of Base Station

You can get information about the synchronization state of the base station - the uptime and to which radio unit it synchronizes on. This is useful when you want to get an overview of the base stations and in case of problem solving.

Checking Sync State

- 1 Click **Administration**, and then click **Base Station**.





Figure 96 Adm. Page Wireless Server: Administration/Base station page

No	Serial	Description	RPN	Cluster	Firmware	Status	Uptime	Sync	PrimSec	Lost
22	8464767	L2 Byg 1.767	22	Default	PCS148_	connected	0.04.13.42		LAN	

Showing 1 to 1 of 1 entries

Synchronization: ● Free running ● Synchronized ✗ Searching ● Unknown

Figure 97 Sync States of Base Station - Color Description

Synchronization:  Free running  Synchronized to primary  Synchronized to alternative 

2 Check the sync state of the base stations:

- If marked with blue: Free running (Sync Master)
- If marked with green: Synchronized (Primary Sync Master)
- If marked with red: Searching (not in sync with any radio unit)
- If marked with grey: Unknown (not connected - base station removed from installation)

**Note**

When you double-click a base station in the list, you can check the RSSI values of the base stations it is synchronizing on (Primary sync/Secondary (Alternative) sync)..

Updating the Spectralink Base Station Firmware

The software of the base station can be updated. To update the software you load a file to the system. Contact your distributor for newest software.

**Note**

The base station firmware is updated from the Administration Page of the Spectralink IP-DECT Server 6500.

Updating Spectralink Base Station Firmware

You can specify a range of base stations to be updated with new firmware.

1 Click **Firmware**, and then click **Base Station**.**Figure 98** Adm. Page WS: Firmware/Base station page

The screenshot shows the 'IP-DECT Server 6500' Administration page with the 'Firmware' tab selected. The 'Update base station firmware' form contains the following fields and buttons:

- Firmware file** section: A text input field for 'Firmware file' and a 'Browse...' button.
- Base stations to update** section: Two text input fields for 'Start base station No *' (containing '0') and 'End base station No *' (containing '1023').
- Buttons: 'Update' and 'Reboot base stations'.
- Footnote: *) Required field

2 In the **Firmware file** field, click **Browse**.

A **Choose File** dialog box appears.

Figure 99 Adm. Page: Choose File dialog box

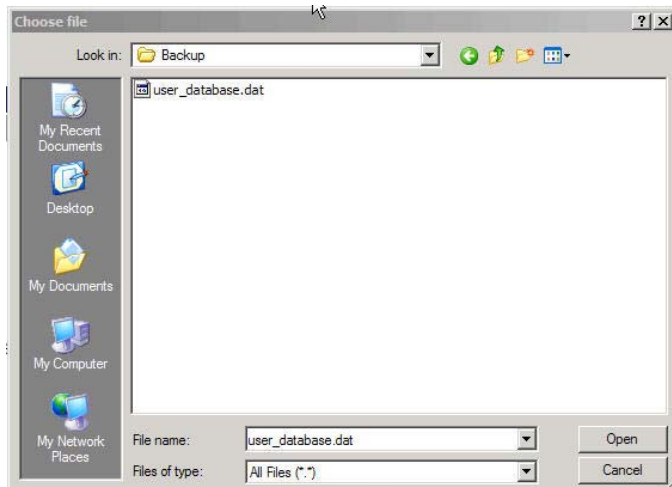

- 3 Select the file in question, and then click **Open**.

The file to select has the extension **.bin**.

- 4 In the **Start RFP No** field, type the number of the first base station to be updated.

Note: You can check base station numbers under **Administration/Base station**.

- 5 In the **End RFP No** field, type the number of the last base station to be updated.

- 6 Click **Update**.

Wait until the system has finished uploading. All base stations in the range specified are updated.

Note: When you have clicked Update, the web browser will go to the base station administration page where you can follow the update process. Use refresh to see real-time update. Each update takes approximately 30 seconds.

- 7 Optionally, you can block new calls during a firmware update by clicking **Administration**, and then **Wireless Server**.

Figure 100 Adm. Page Wireless Server: Administration/Wireless Server page

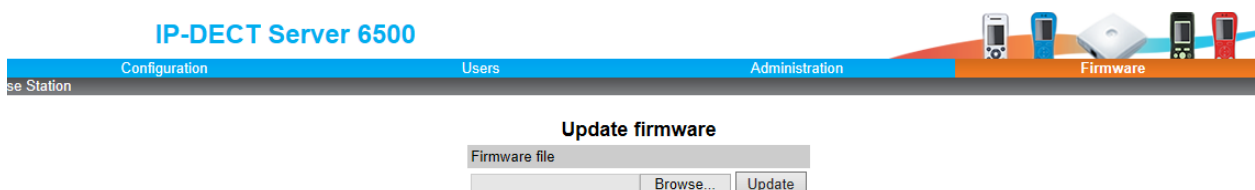

Under **Service Status** click **Block**.

- 8 When the update is finished, click **Reboot** to execute the changes.
- 9 If you have blocked new calls during a firmware update, enable new calls again by clicking **Administration**, then **Wireless Server** and then clicking **Allow**.

Chapter 13: Messaging over MSF

This section provides you with information about writing MSF messages (Message Service Function) using the web based Administration Page of the Spectralink IP-DECT Server 6500.

With the MSF messages function you can send text messages to any MSF compatible handset connected to the Spectralink IP-DECT Server 6500.

Description of Different Types of MSF Messages

It is possible to send MSF messages from handset to handset, from handset to server and from server to handset. Each text message can consist of up to 72 characters. A handset can receive a text message whether it is on or off hook. Reception of a text message is signalled by a beep tone.

With messaging it is possible to send two different types of messages:

- **On Way Text**

A message which does not require an answer from the recipient. Examples of One Way Texts include reminders, updates and basic notifications such as "Remember the meeting at 3 PM".

One Way Text is also called Fire and Forget.

Confirmation of messages having been sent and received is available in the system as an acknowledgement of each message having reached the handset display.

- **Two Way Text**

A message which the recipient can answer by returning relevant keypad information to the sender. An example of Two Way Text could be sending the following message to a number of users; "Who will attend the meeting at 3 PM?". Each recipient answers the message using the keypad and the Administration Page can then send message updates and, if needed, include a call back number in the message.

Adding a call back number makes it possible for the recipient to call the number automatically simply by pressing the off hook button. When a call back number is included, the message can consist of a maximum of 36 characters.

Two Ways Text is also called "Text call".

Confirmation of sent messages having been received is done by the recipient answering the message. It is also shown in the system as an acknowledgement of each message having reached the handset display. If a message does not receive an answer within a specified period of time (for instance 30 seconds) it is possible to preset the system to automatically send it to another relevant user.

When writing an MSF message it is possible to send it:

- An MSF message can be sent to a single handset as a Two Way Text message.

The system can handle a maximum of 26-30 messages per minute being sent simultaneously from the system to a number of handsets.

- Broadcast

An MSF message can be sent to all handsets at the same time as a One Way Text message.

The system can handle a maximum of 26-30 messages per minute to all handsets simultaneously from the system.

Sending Text Messages

The MSF messages function requires the use of a third-party application, such as an alarm server.

For demonstration, Spectralink has an MSF package including:

- XML RPC Document
- Description of the XML RPC protocol
- Simple example in VB.net, Java, C# using the dll interface including source code

For more information about obtaining the Spectralink MSF package, contact Spectralink.

Chapter 14: Regulatory Notices

This section contains important safety regulations for the Spectralink IP-DECT Server 6500.

International Regulatory and Product Information

	<p>This Spectralink product has been marked with the CE mark. This mark indicates compliance with EEC Directives 2006/95/EC. A full copy of the Declaration of Conformity can be obtained from: Spectralink Europe ApS, Langmarksvej 34, 8700 Horsens, Denmark</p>
---	--

Cesky [Czech]:	Spectralink tímto prohlašuje, že tento Spectralink Spectralink IP-DECT Server 6500 Server je ve shodě se základními požadavky a dalšími příslušnými ustanoveními směrnice 2004/108/EC.
Dansk [Danish]:	Undertegnede Spectralink erklærer herved, at følgende udstyr Spectralink Spectralink IP-DECT Server 6500 Server overholder de væsentlige krav og øvrige relevante krav i direktiv 1999/5/EF.
Deutsch [German]:	Hiermit erklärt Spectralink (UK) Ltd, dass sich das Gerät Spectralink Spectralink IP-DECT Server 6500 Server in Übereinstimmung mit den grundlegenden Anforderungen und den übrigen einschlägigen Bestimmungen der Richtlinie 1999/5/EG befindet.
Eesti [Estonian]:	Käesolevaga kinnitab Spectralink seadme Spectralink Spectralink IP-DECT Server 6500 Server vastavust direktiivi 1999/5/EÜ põhinõuetele ja nimetatud direktiivist tulenevatele teistele asjakohastele sätetele.
English:	Hereby, Spectralink declares that this Spectralink Spectralink IP-DECT Server 6500 Server is in compliance with the essential requirements and other relevant provisions of Directive 2006/95/EC.
Español [Spanish]:	Por medio de la presente Spectralink declara que el Spectralink Spectralink IP-DECT Server 6500 Server cumple con los requisitos esenciales y cualesquiera otras disposiciones aplicables o exigibles de la Directiva 2006/95/EC.

Ελληνική [Greek]:	ΜΕ ΤΗΝ ΠΑΡΟΥΣΑ Spectralink ΔΗΛΩΝΕΙ ΟΤΙ Spectralink Spectralink IP-DECT Server 6500 Server ΣΥΜΜΟΡΦΩΝΕΤΑΙ ΠΡΟΣ ΤΙΣ ΟΥΣΙΩΔΕΙΣ ΑΠΑΙΤΗΣΕΙΣ ΚΑΙ ΤΙΣ ΛΟΙΠΕΣ ΣΧΕΤΙΚΕΣ ΔΙΑΤΑΞΕΙΣ ΤΗΣ ΟΔΗΓΙΑΣ 1999/5/ΕΚ.
Français [French]:	Par la présente Spectralink déclare que l'appareil Spectralink Spectralink IP-DECT Server 6500 Server est conforme aux exigences essentielles et aux autres dispositions pertinentes de la directive 2006/95/EC.
Italiano [Italian]:	Con la presente Spectralink dichiara che questo Spectralink Spectralink IP-DECT Server 6500 Server è conforme ai requisiti essenziali ed alle altre disposizioni pertinenti stabilite dalla direttiva 2006/95/EC.
Íslenska (Icelandic):	Hér með lýsir Spectralink yfir því að Spectralink Spectralink IP-DECT Server 6500 Server er í samræmi við grunnkröfur og aðrar kröfur, sem gerðar eru í tilskipun 2006/95/EC
Latviski [Latvian]:	Ar šo Spectralink deklare, ka Spectralink Spectralink IP-DECT Server 6500 Server atbilst Direktīvas 1999/5/EK būtiskajam prasībam un citiem ar to saistītajiem noteikumiem.
Lietuviu [Lithuanian]:	Šiuo Spectralink deklaruoja, kad šis Spectralink Spectralink IP-DECT Server 6500 Server atitinka esminius reikalavimus ir kitas 1999/5/EB Direktyvos nuostatas.
Nederlands [Dutch]:	Hierbij verklaart Spectralink dat het toestel Spectralink Spectralink IP-DECT Server 6500 Server in overeenstemming is met de essentiële eisen en de andere relevante bepalingen van richtlijn 1999/5/EG.
Malti [Maltese]:	Hawnhekk, Spectralink (UK) Ltd, jiddikjara li dan Spectralink Spectralink IP-DECT Server 6500 Server jikkonforma mal-htigijiet essenzjali u ma provvedimenti oħrajn relevanti li hemm fid-Dirrettiva 2006/95/EC.
Magyar [Hungarian]:	Alulírott, Spectralink nyilatkozom, hogy a Spectralink Spectralink IP-DECT Server 6500 Server megfelel a vonatkozó alapvető követelményeknek és az 2006/95/EC irányelv egyéb előírásainak.
Norsk [Norwegian]:	Spectralink erklærer herved at utstyret Spectralink Spectralink IP-DECT Server 6500 Server er i samsvar med de grunnleggende krav og øvrige relevante krav i direktiv 1999/5/EF.
Polski [Polish]:	Niniejszym Spectralink oświadcza, że Spectralink Spectralink IP-DECT Server 6500 Server jest zgodne z zasadniczymi wymaganiami oraz innymi stosownymi postanowieniami Dyrektywy 1999/5/WE
Português [Portuguese]:	Spectralink declara que este Spectralink Spectralink IP-DECT Server 6500 Server está conforme com os requisitos essenciais e outras disposições da Directiva 2006/95/EC.
Slovensko [Slovenian]:	Spectralink izjavlja, da je ta Spectralink Spectralink IP-DECT Server 6500 Server v skladu z bistvenimi zahtevami in ostalimi relevantnimi določili direktive 2004/108/EC.

Slovensky [Slovak]:	Spectralink týmto vyhlasuje, že Spectralink Spectralink IP-DECT Server 6500 Server splna základné požiadavky a všetky príslušné ustanovenia Smernice 2004/108/EC.
Suomi [Finnish]:	Spectralink vakuuttaa täten että Spectralink Spectralink IP-DECT Server 6500 Server tyyppinen laite on direktiivin 1999/5/EY oleellisten vaatimusten ja sitä koskevien direktiivin muiden ehtojen mukainen.
Svenska [Swedish]:	Härmed intygar Spectralink att denna Spectralink Spectralink IP-DECT Server 6500 Server står i överensstämmelse med de väsentliga egenskapskrav och övriga relevanta bestämmelser som framgår av direktiv 1999/5/EG.

Explosive Device Proximity Warning

	Warning. Do not operate your wireless network device near unshielded blasting caps or in an explosive environment unless the device has been modified to be especially qualified for such use.
---	---

Waarschuwing	Gebruik dit draadloos netwerkapparaat alleen in de buurt van onbeschermd ontstekers of in een omgeving met explosieven indien het apparaat speciaal is aangepast om aan de eisen voor een dergelijk gebruik te voldoen.
Varoitus	Älä käytä johdotonta verkkolaitetta suojaamattomien räjäytysnallien läheisyydessä tai räjäytysalueella, jos laitetta ei ole erityisesti muunnettu sopivaksi sellaiseen käyttöön.
Attention	Ne jamais utiliser un équipement de réseau sans fil à proximité d'un détonateur non blindé ou dans un lieu présentant des risques d'explosion, sauf si l'équipement a été modifié à cet effet.
Warnung	Benutzen Sie Ihr drahtloses Netzwerkgerät nicht in der Nähe ungeschützter Sprengkapseln oder anderer explosiver Stoffe, es sei denn, Ihr Gerät wurde eigens für diesen Gebrauch modifiziert und bestimmt.
Avvertenza	Non utilizzare la periferica di rete senza fili in prossimità di un detonatore non protetto o di esplosivi a meno che la periferica non sia stata modificata a tale proposito.
Advarsel	ikke bruk den trådløse nettverksenheten nært inntil uisolerte fenghetter eller i et eksplosivt miljø med mindre enheten er modifisert slik at den tåler slik bruk.
Aviso	Não opere o dispositivo de rede sem fios perto de cápsulas explosivas não protegidas ou num ambiente explosivo, a não ser que o dispositivo tenha sido modificado para se qualificar especialmente para essa utilização.

¡Advertencia!	No utilizar un aparato de la red sin cable cerca de un detonador que no esté protegido ni tampoco en un entorno explosivo a menos que el aparato haya sido modificado con ese fin.
Varning!	Använd inte den trådlösa nätverksenheten i närheten av oskyddade tändhättar eller i en explosiv miljö om inte enheten modifierats för att kunna användas i sådana sammanhang.

	The WEEE Marking on this equipment indicates that the product must not be disposed of with unsorted waste, but must be collected separately.
---	---

Appropriate RF safety/installation information

The product is intended to be installed by authorized personal. The product shall be installed in accordance with FCC rules.

WARNING

This is a class A product. In a domestic environment this product may cause radio interference in which case the user may be required to take adequate measures. The above warning is inserted for regulatory reasons. If any customer believes that they have an interference problem, either because their Spectralink product seems to cause interference or suffers from interference, they should contact their distributor immediately. The distributor will assist with a remedy for any problems and, if necessary, will have full support from Spectralink.

Safety

WARNING!

Only qualified service personnel may install this equipment. The instructions in this manual are intended for use by qualified service personnel only.

Only qualified persons should service the system

The installation and service of this hardware is to be performed only by service personnel having appropriate training and experience necessary to be aware of hazards to which they are exposed in performing a task and of measures to minimize the danger to themselves or other persons.

Electrical shock hazards from the telecommunication network and AC mains are possible with this equipment. To minimize risk to service personnel and users, the system must be connected to an outlet with a third-wire Earth.

Service personnel must be alert to the possibility of high leakage currents becoming available on metal system surfaces during power line fault events near network lines. These leakage currents normally safely flow to Protective Earth via the power cord. Therefore, it is mandatory that connection to an earthed outlet is performed first and removed last when cabling to the unit. Specifically, operations requiring the unit to be powered down must have the network connections (exchange lines) removed first.

Important Safety Instructions and Product Information

Before using your telephone equipment, you should always follow basic safety instruction to reduce the risk of fire, electrical shock and injury to persons, and damage to property.

- 1 Read and understand all instructions
- 2 Follow all warnings and instructions including those marked on the product
- 3 Unplug this product before cleaning. Do not use liquid cleaners or aerosol cleaners. Use damp cloth for cleaning
- 4 Do not install the telephone equipment in the bathroom or near a wash bowl, kitchen sink, or laundry tub, in a wet basement, or near a swimming pool
- 5 The product should be operated only from the type of power source indicated on the instructions. If you are not sure of the type of power supply, consult your dealer or local power company.
- 6 Do not overload wall outlets and extension cords as this can result in fire or electrical shock.
- 7 Never push objects of any kind into this product through cabinet slots as they may touch dangerous voltage points or short out parts that could result in fire, electrical shock, or injury. Never spill liquid of any kind into this product.

- 8** To reduce the risk of electrical shock or burns, do not disassemble this product. Opening or removing covers may expose you to dangerous voltages, dangerous electrical current, or other risks. Incorrect reassemble can cause electrical shock when the appliance is subsequently used. If the product need repair, consult your dealer.
- 9** This product does not support connections to outside plant.
- 10** Refer servicing to qualified service personnel under the following conditions:
 - If liquid has been spilled into the product
 - If the product has been exposed to rain or water
 - If the product does not operate normally when following the operating instructions in the manual. Adjust only those controls that are covered by the operation instructions. Improper adjustment of other controls may result in damage and will often require extensive work by qualified service personnel to restore the product to normal operation.
 - If the product has been dropped or cabinet has been damaged
 - If the product exhibits a distinct change in performance

Warning

- 11** Avoid using telephone during an electrical storm. There may be a risk of electrical shock from lightning
- 12** Do not use the telephone to report a gas leak in the vicinity of the leak
- 13** Do not place the unit near microwave ovens, radio equipment, or non-ground connected televisions. These appliances may cause electrical interference to the base or handset
- 14** Installation must be performed in accordance with all relevant national wiring rules
- 15** Plug acts as Disconnect Device - The socket outlet to which this apparatus is connected must be installed near the equipment and must always be readily accessible
- 16** The system will not operate in the event of a blackout. Please keep a backup phone for emergencies

Intrinsic safety

Do not install the unit in conditions where there is a danger of electrically ignited explosions.

Exposure to sunlight, heat and moisture

Do not expose the unit to direct sunlight for long periods. Keep away from excessive heat and moisture.

Spare parts and accessories

Use only approved spare parts and accessories. The operation of non-approved parts cannot be guaranteed and may even cause damage.

RF compliance information

The users manual or instruction manual for an intentional or unintentional radiator shall caution the user that changes or modifications not expressly approved by the party responsible for compliance could void the user's authority to operate the equipment.

NOTICES

FCC Note: This device complies with Part 15 of the FCC rules. Operation is subject to the following two conditions: (1) This device may not cause harmful interference, and (2) this device must accept any interference received, including interference that may may cause undesired operation. FCC ID: PXARFP12IP-1G9.

IC Note: Operation is subject to the following two conditions: (1) This device may not cause interference, and (2) this device must accept any interference, including interference that may cause undesired operation of the device.

Privacy of communications may not be ensured when using this telephone.

Information to user: The users manual or instruction manual for an intentional or unintentional radiator shall caution the user that changes or modifications not expressly approved by the party responsible for compliance could void the user's authority to operate the equipment.

LIMITED WARRANTY

This limited, non-transferable warranty is provided to the original purchaser. The product is warranted to be free from defects in materials and workmanship under normal installation, use and service for a period of one (1) year from the date of purchase as shown on the purchaser's receipt.

Our obligation under this warranty is limited to repair or replacement (at our option) of the product or any part(s) which are defective provided that the product is returned to the original place of purchase or an authorized service location during the warranty period. Products returned must be accompanied by a copy of the purchase receipt. In the absence of a purchase receipt, the warranty period shall be one (1) year from the date of manufacture. Repair or replacement of the product is your sole and exclusive remedy.

If the product is repaired, reconditioned component parts or materials may be used. If the product is replaced, we may replace it with a new or reconditioned product of the same or similar design. The repaired product will be warranted for either (a) 90 days or (b) the remainder of the original one (1) year warranty period, whichever is longer.

This warranty does not apply to the defects outside of our control, including but not limited to acts of God, fire, flood and damage while in transit to service facility. We do not warranty that the product will be compatible with any telephone equipment, systems or party lines.

This warranty shall be void if the product is damaged as a result of defacement, misuse, abuse, neglect, accident, destruction or alteration of the serial number, improper electrical voltages or currents, repair, alteration or maintenance by any person or party other than our authorized service facility, or any violation of instructions furnished by us.

This warranty is also void if this product is removed from the country in which it was purchased by the original purchaser, if it is used in a country in which it is not registered for use, or if it is used in a country for which it was not designed. Due to variations in telephone systems and

communications laws, this product may be illegal for use in some countries. We assume no responsibilities for damages or penalties incurred resulting from the use of this product in a manner or location other than that for which it was intended.

THIS LIMITED WARRANTY IS IN LIEU OF ALL OTHER WARRANTIES EXPRESS OR IMPLIED. ANY IMPLIED WARRANTIES INCLUDING BUT NOT LIMITED TO THE IMPLIED WARRANTIES OF MERCHANTABILITY AND FITNESS FOR A PARTICULAR PURPOSE, SHALL BE LIMITED TO THE DURATION OF THIS WRITTEN LIMITED WARRANTY. WE DISCLAIM ANY LIABILITY FOR DAMAGES FOR LOSS OF USE OF THE PRODUCTS, LOSS OF TIME, INCONVENIENCE, INJURY TO ANY PERSON, OR DAMAGE TO PROPERTY CAUSED BY THE PRODUCT, LOSS OF REVENUE OR PROFIT OR DAMAGES FOR ANY FAILURE TO PERFORM. IN NO EVENT SHALL WE BE LIABLE FOR ANY SPECIAL, INCIDENTAL, PUNITIVE OR CONSEQUENTIAL DAMAGES EVEN IF WE ARE ADVISED OF THE POSSIBILITY OF SUCH DAMAGES.

Some states do not allow limitations on how long an implied warranty lasts, so the above limitations may not apply to you. This warranty is the sole and exclusive warranty provided for the product. There are no other express warranties. This warranty gives you specific legal rights, and you may also have other rights, which vary from state to state.

Chapter 15: Open Source Software Notice.

Open Source Software Notice

This product includes certain open source or other software originated from third parties that are subject to the GNU General Public License (GPLv2), GNU Library/Lesser General Public License (LGPLv2) and different and/or additional copyright licenses, disclaimers and notices. Please refer to the exact terms of the GPLv2 and LGPLv2 regarding your rights under said license. You may obtain a complete corresponding machine-readable copy of the source code of such software under the GPLv2 or LGPLv2 at

<http://support.spectralink.com/SpectralinkService/support/us/support/voice/index.html>.

Alternatively, Spectralink offers to provide such source code to you on CD-ROM for a charge covering the cost of performing such distribution, such as the cost of media, shipping and handling, upon written request to Spectralink at:

Source Code Requests
Spectralink Europe ApS
Langmarksvej 34
DK-8700 Horsens
Denmark

This offer is valid for a period of three (3) years from the date of the distribution of this product by Spectralink.

Appendix 1: Repeater Numbering

In a multi cell solution, the numbering of the base stations and repeaters has to follow the numbering in the following table.

Table 7 Repeater numbering

Base Station	Repeater 1	Repeater 2	Repeater 3
0	64	128	192
1	65	129	193
2	66	130	194
3	67	131	195
4	68	132	196
5	69	133	197
6	70	134	198
7	71	135	199
8	72	136	200
9	73	137	201
10	74	138	202
11	75	139	203
12	76	140	204
13	77	141	205
14	78	142	206
15	79	143	207
16	80	144	208
17	81	145	209
18	82	146	210
19	83	147	211
20	84	148	212
21	85	149	213
22	86	150	214
23	87	151	215
24	88	152	216
25	89	153	217
26	90	154	218
27	91	155	219
28	92	156	220
29	93	157	221
30	94	158	222

Base Station	Repeater 1	Repeater 2	Repeater 3
31	95	159	223
32	96	160	224
33	97	161	225
34	98	162	226
35	99	163	227
36	100	164	228
37	101	165	229
38	102	166	230
39	103	167	231
40	104	168	232
41	105	169	233
42	106	170	234
43	107	171	235
44	108	172	236
45	109	173	237
46	110	174	238
47	111	175	239
48	112	176	240
49	113	177	241
50	114	178	242
51	115	179	243
52	116	180	244
53	117	181	245
54	118	182	246
55	119	183	247
56	120	184	248
57	121	185	249
58	122	186	250
59	123	187	251
60	124	188	252
61	125	189	253
62	126	190	254
63	127	191	255
64	128	192	0
65	129	193	1
66	130	194	2
67	131	195	3
68	132	196	4

Base Station	Repeater 1	Repeater 2	Repeater 3
69	133	197	5
70	134	198	6
71	135	199	7
72	136	200	8
73	137	201	9
74	138	202	10
75	139	203	11
76	140	204	12
77	141	205	13
78	142	206	14
79	143	207	15
80	144	208	16
81	145	209	17
82	146	210	18
83	147	211	19
84	148	212	20
85	149	213	21
86	150	214	22
87	151	215	23
88	152	216	24
89	153	217	25
90	154	218	26
91	155	219	27
92	156	220	28
93	157	221	29
94	158	222	30
95	159	223	31
96	160	224	32
97	161	225	33
98	162	226	34
99	163	227	35
100	164	228	36
101	165	229	37
102	166	230	38
103	167	231	39
104	168	232	40
105	169	233	41
106	170	234	42

Base Station	Repeater 1	Repeater 2	Repeater 3
107	171	235	43
108	172	236	44
109	173	237	45
110	174	238	46
111	175	239	47
112	176	240	48
113	177	241	49
114	178	242	50
115	179	243	51
116	180	244	52
117	181	245	53
118	182	246	54
119	183	247	55
120	184	248	56
121	185	249	57
122	186	250	58
123	187	251	59
124	188	252	60
125	189	253	61
126	190	254	62
127	191	255	63
128	192	0	64
129	193	1	65
130	194	2	66
131	195	3	67
132	196	4	68
133	197	5	69
134	198	6	70
135	199	7	71
136	200	8	72
137	201	9	73
138	202	10	74
139	203	11	75
140	204	12	76
141	205	13	77
142	206	14	78
143	207	15	79
144	208	16	80

Base Station	Repeater 1	Repeater 2	Repeater 3
145	209	17	81
146	210	18	82
147	211	19	83
148	212	20	84
149	213	21	85
150	214	22	86
151	215	23	87
152	216	24	88
153	217	25	89
154	218	26	90
155	219	27	91
156	220	28	92
157	221	29	93
158	222	30	94
159	223	31	95
160	224	32	96
161	225	33	97
162	226	34	98
163	227	35	99
164	228	36	100
165	229	37	101
166	230	38	102
167	231	39	103
168	232	40	104
169	233	41	105
170	234	42	106
171	235	43	107
172	236	44	108
173	237	45	109
174	238	46	110
175	239	47	111
176	240	48	112
177	241	49	113
178	242	50	114
179	243	51	115
180	244	52	116
181	245	53	117
182	246	54	118

Base Station	Repeater 1	Repeater 2	Repeater 3
183	247	55	119
184	248	56	120
185	249	57	121
186	250	58	122
187	251	59	123
188	252	60	124
189	253	61	125
190	254	62	126
191	255	63	127
192	0	64	128
193	1	65	129
194	2	66	130
195	3	67	131
196	4	68	132
197	5	69	133
198	6	70	134
199	7	71	135
200	8	72	136
201	9	73	137
202	10	74	138
203	11	75	139
204	12	76	140
205	13	77	141
206	14	78	142
207	15	79	143
208	16	80	144
209	17	81	145
210	18	82	146
211	19	83	147
212	20	84	148
213	21	85	149
214	22	86	150
215	23	87	151
216	24	88	152
217	25	89	153
218	26	90	154
219	27	91	155
220	28	92	156

Base Station	Repeater 1	Repeater 2	Repeater 3
221	29	93	157
222	30	94	158
223	31	95	159
224	32	96	160
225	33	97	161
226	34	98	162
227	35	99	163
228	36	100	164
229	37	101	165
230	38	102	166
231	39	103	167
232	40	104	168
233	41	105	169
234	42	106	170
235	43	107	171
236	44	108	172
237	45	109	173
238	46	110	174
239	47	111	175
240	48	112	176
241	49	113	177
242	50	114	178
243	51	115	179
244	52	116	180
245	53	117	181
246	54	118	182
247	55	119	183
248	56	120	184
249	57	121	185
250	58	122	186
251	59	123	187
252	60	124	188
253	61	125	189
254	62	126	190
255	63	127	191

Appendix 2: Overview of Ports and Protocols

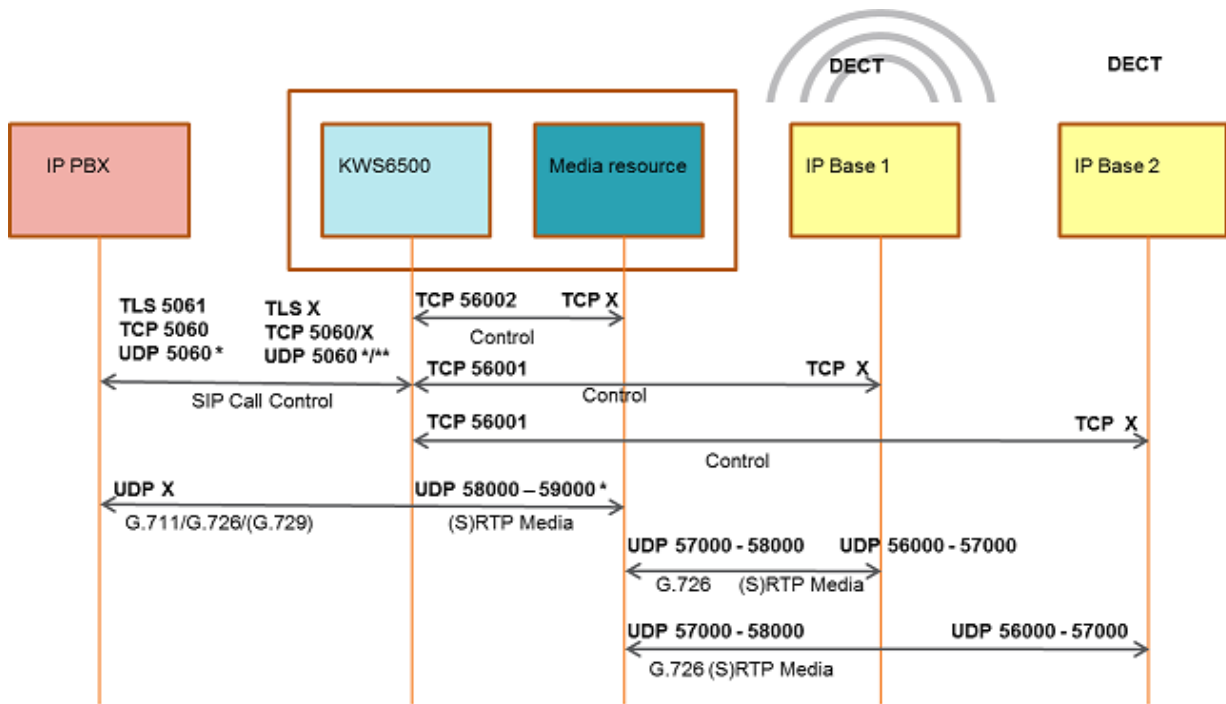

* = Default – configurable

** If SIP per port registration is checked = 15061 + (Number of SIP Registration)

In addition the KWS6500 system can utilize the following protocols: HTTP/HTTPS, FTP/TFTP, UPnP, MSF (TCP port 56003), syslog (UDP port 514), NTP, LDAP

Releated Documentation	5
Overview of System Capacity	9
Spectralink IP-DECT Server 6500 Part Numbers	15
Spectralink Media Resource Part Numbers	16
LED Indicator Description - Front Faceplate	17
LED Indicator Description - Front Lan port	17
Reset Button Description	18
Spectralink Base Station Part Numbers	23
LED Indicator Description - Front Cover	25
.....	25
Reset Button Description	26
Repeaters and Part Numbers	30
Repeater numbering	116

Figures

Overview of the Whole Solution	8
Add-on media resource for empty slot in a Server 6500 Rack	16
Spectralink IP-DECT Server 6500/Media Resource - Front	16
Spectralink IP-DECT Server 6500/Media Rack Mounting	18
Base Station - Front view	24
Base Station - Front	24
LED Indicator Description - LAN port	25
Base Station Wall Mounting	27
Base Station - Ethernet Connector	28
Repeater	31
Connect Power to the Bottom of the Repeater and External Antenna Cable to the Rear of the Repeater	33
Programming Kit Repeater	35
Use of Repeaters	37
Using UPnP to discover Spectralink IP-DECT Server 6500	40
Direct connection patch cable (RJ45)	41
Main page of the Administration Page for wireless server	42
Adm. Page: Enter Network Password dialog box	42
Spectralink IP-DECT Server 6500 installation	43
Adm. Page WS: Configuration/General page	44
Wireless Server Configuration	45
Adm. Page WS: Configuration/Media Resource page	46
Adm. Page WS: Configuration/SIP page	46
Adm. Page: Configuration/Security page	50
Synchronization Chain	53
Synchronization Chain Layout without Alternative Sync Ways	53
Synchronization Chain with Alternative Sync Ways	54
Synchronization Chain with Alternative Sync Ways	54
Synchronization Chain with Alternative Sync Ways	55
Synchronization Chain Layout with Alternative Sync Ways	55
Synchronization Chain With and Without Alternative Sync Ways	56
Synchronization Chain With Repeaters	57
Adm. Page Media Resource: Config./Media Resource page	58
Cross-Over Patch Cable (RJ45)	61
	61
Main page of the Administration Page for base station	62
Adm. Page: Enter Network Password dialog box	62
Adm. Page Base Station: Configuration/General page	63

Adm. Page Base Station: Configuration/Security page	65
Configuration/Base Station	66
Adm. Page WS:Administration/Base station page	67
Adm. Page WS:Administration/Base station page	67
Adm. Page WS: Users/List Users page	70
Adm. Page WS: Users/List Users/Users page	70
Adm. Page WS: Users/List Users page	72
Adm. Page WS: Users/List Users page	73
Adm. Page WS: Users/List Users page	75
Adm. Page WS: Users/List Users/User page	75
Warning box	75
Adm. Page WS: Users/List Users page	76
Adm. Page WS: Users/List Users/User page	76
Adm. Page WS: Users/Import/Export page	77
Adm. Page: File Download dialog box.	77
Adm. Page: Save As dialog box	78
Adm. Page WS: Users/Import/Export page	78
Adm. Page: Choose File dialog box	79
Adm. Page WS: Users/Import/Export/Loaded page	79
Adm. Page: Reboot Warning message	79
Example of Handset Registration Data in CSV Format	80
Adm. Page WS: Users/Import/Export page	80
Adm. Page: Choose File dialog box	81
Adm. Page WS: Configuration/Security page	82
Adm. Page Wireless Server: Status/General page	83
Adm. Page WS: Status/Logs page	84
Adm. Page: Save As dialog box	85
Adm. Page Wireless Server: Status/Wireless Server page	85
Adm. Page Wireless Server: Statistics/Wireless Server page	86
Warning message	86
Adm. Page Wireless Server: Statistics/Media Resource page	87
Adm. Page Wireless Server: Statistics/Base Station page	87
Adm. Page Wireless Server: Statistics/Active Calls page	87
Adm. Page Wireless Server: Statistics/Abnormal Releases page	88
Adm. Page Wireless Server: Statistics/Traffic Distribution page	88
Adm. Page Wireless Server: Configuration/Backup/Restore page	88
File Download dialog box	89
Save As dialog box	89
Adm. Page Wireless Server: Configuration/Backup/Restore page	90
Adm. Page: Choose File dialog box	90

Adm. Page Wireless Server: Firmware/Wireless Server page	91
Adm. Page: Choose File dialog box	91
Adm. Page: Firmware Update Progress Bar	91
Adm. Page Server: Administration/Wireless Server page	92
Adm. Page Wireless Server: Administration/Wireless Server page	93
Warning box	93
Adm. Page Media Resource: Configuration/Security page	93
Adm. Page Media Resource: Status/General page	94
Adm. Page Media Resource: Status/Logs page	95
Adm. Page: Save As dialog box	96
Adm. Page Media Resource: Firmware/Media Resource page	97
Adm. Page: Choose File dialog box	97
Adm. Page: Firmware Update Progress Bar	98
Adm. Page Wireless Server: Administration/Wireless Server page	98
Adm. Page Base Station: Configuration/Security page	99
Adm. Page Base Station: Status/General page	100
Adm. Page Base Station: Status/Logs page	101
Adm. Page: Save As dialog box	102
Adm. Page Wireless Server: Administration/Base station page	102
Sync States of Base Station - Color Description	103
Adm. Page WS: Firmware/Base station page	103
Adm. Page: Choose File dialog box	104
Adm. Page Wireless Server: Administration/Wireless Server page	104