

# SIP-DECT OM System Manual

INSTALLATION, MAINTENANCE & ADMINISTRATION GUIDE  
RELEASE 6.2



---

## NOTICE

The information contained in this document is believed to be accurate in all respects but is not warranted by Mitel Networks™ Corporation (MITEL®). The information is subject to change without notice and should not be construed in any way as a commitment by Mitel or any of its affiliates or subsidiaries. Mitel and its affiliates and subsidiaries assume no responsibility for any errors or omissions in this document. Revisions of this document or new editions of it may be issued to incorporate such changes.

No part of this document can be reproduced or transmitted in any form or by any means - electronic or mechanical - for any purpose without written permission from Mitel Networks Corporation.

## TRADEMARKS

The trademarks, service marks, logos and graphics (collectively "Trademarks") appearing on Mitel's Internet sites or in its publications are registered and unregistered trademarks of Mitel Networks Corporation (MNC) or its subsidiaries (collectively "Mitel") or others. Use of the Trademarks is prohibited without the express consent from Mitel. Please contact our legal department at [legal@mitel.com](mailto:legal@mitel.com) for additional information. For a list of the worldwide Mitel Networks Corporation registered trademarks, please refer to the website: <http://www.mitel.com/trademarks>.

Mitel's Power Over Ethernet (PoE) Powered Device (PD) products are covered by one or more of the U.S. patents (and any foreign patent counterparts thereto) identified at Mitel's website: [www.mitel.com/patents](http://www.mitel.com/patents).

For more information on the PD patents that are licensed, please refer to [www.cm spatents.com](http://www.cm spatents.com).

SIP-DECT OM System Manual  
Release 6.2  
July 2016

®,™ Trademark of Mitel Networks Corporation  
© Copyright 2016 Mitel Networks Corporation  
All rights reserved

---

---

# CONTENTS

<b>1</b>	<b>Overview</b>	<b>10</b>
1.1	The SIP-DECT Solution	10
1.2	About DECT Base Stations	11
1.2.1	DECT Base Station Families	11
1.2.2	RFP only Mode	14
1.2.3	OpenMobility Manager (OMM) Mode	14
1.3	About the OpenMobility Manager	14
1.3.1	OMM Tasks	15
1.3.2	SIP-DECT Special Features and Capabilities	16
1.3.3	OMM Capacities and Features	16
1.4	About DECT Phones	17
1.5	File naming conventions	17
1.6	Login and passwords	18
<b>2</b>	<b>Getting Started</b>	<b>19</b>
2.1	Base Station Startup Configuration	19
2.2	System Configuration	19
2.3	System Settings	20
2.4	Base Stations	21
2.5	SIP settings	22
2.6	DECT Phones	23
2.6.1	DECT Phone and SIP state verification	24
<b>3</b>	<b>Enhanced Feature Overview</b>	<b>25</b>
3.1	PC-based OMM installation	25
3.2	DECT XQ	25
3.3	Wideband (CAT-iq 1.0 / Mitel Hi-Q™ audio technology)	26
3.4	DECT enhanced security	26
3.5	VoIP encryption	27
3.6	Mixed DECT base station installations	27
3.7	Wireless LAN (WLAN)	27
3.7.1	802.11i: WPA2-Enterprise Pre-Authentication for fast Roaming	27
3.7.2	Channel Configuration Feedback for HT40 and tx Power	28
3.8	DECT base station synchronization	28
3.8.1	Clustering and paging areas	28
3.9	DECT base station Reset to Factory Settings	28
3.10	System redundancy	29
3.10.1	OMM standby	29
3.10.2	Backup SIP proxy/registrar	29
3.10.3	Configurable User Account for Standby Check	29
3.10.4	User data synchronization (MiVoice 5000 dual homing support)	29
3.11	Simplified licensing	30
3.12	Extended regulatory domain support	30
3.13	DECT phone functionality	30
3.13.1	DECT Phone Download over Air	30
3.13.2	Central DECT Phone Configuration Over Air (CoA)	31
3.13.3	OMM DECT phone provisioning	31
3.13.4	Mitel 600 DECT Phone Dial Editor Mode	32
3.13.5	Mitel 602 DECT Phone Customizable Boot Texts	32
3.14	Hot Desking	32
3.15	Conferencing	32
3.15.1	Conferencing audio notification	33
3.15.2	Centralized conferencing with MiVoice Business	33
3.16	SIP over UDP/TCP/TLS	33
3.17	SIP multiport	34
3.18	UTF-8 encoding	35
3.19	Alphanumeric dialing	35
3.20	Voice mail number	35

---

3.21	Call handling	36
3.21.1	Diversion indication	36
3.21.2	Call completed elsewhere	36
3.21.3	Semi-Attended Transfer	36
3.21.4	Third Line Handling for Mitel 142d and 600 DECT Phones	37
3.21.5	Call Transfer Enhancements for Mitel 142d DECT phones	38
3.22	Truncating SIP User Name in SIP URI	38
3.23	OM Locating application	38
3.24	Extended messaging	39
3.25	Video support	39
3.25.1	USB Video Devices	39
3.25.2	Terminal Video	40
3.26	User monitoring	41
3.27	Corporate directory integration	42
3.28	Integration into external management systems	42
3.29	System configuration tools	42
3.30	SIP enhancements	43
3.30.1	Globally Routable User-Agent URIs (GRUUs)	43
3.30.2	Session timer	43
3.30.3	SIP Contact matching	43
3.30.4	Configurable Call reject state codes	43
3.30.5	Call release timers	44
3.30.6	Incoming call timeout	44
3.31	Auto answer, intercom calls and audio settings	44
3.31.1	Intercom Calls	44
3.31.2	Auto answer audio settings	45
3.32	SIP-DECT XML terminal interface	45
3.32.1	Feature Access Codes Translation	46
3.32.2	Ring Tone Selection for (Alarm) Messages	46
<b>4</b>	<b>Licensing .....</b>	<b>47</b>
4.1	Licensing Model	47
4.1.1	System Licenses	47
4.1.2	About G.729 Channels	48
4.1.3	PARK Service	48
4.1.4	Upgrade License	49
4.1.5	Grace Period	49
4.1.6	License Violations and Restrictions	50
4.2	Uploading a License File	50
4.3	License Models	51
4.3.1	Small System (Unlicensed)	51
4.3.2	Medium or Large System	51
<b>5</b>	<b>OMM Web Service.....</b>	<b>52</b>
5.1	Login	52
5.2	Logout	53
5.3	“Status” Menu	53
5.4	“System” Menu	53
5.4.1	“System Settings” Menu	54
5.4.2	”Provisioning” Menu	63
5.4.3	”SIP” Menu	65
5.4.4	“User administration” Menu	75
5.4.5	“Time zones” Menu	76
5.4.6	“SNMP” Menu	77
5.4.7	“DB management” Menu	78
5.4.8	“Event log” Menu	81
5.5	“Sites” Menu	82
5.5.1	Creating a New Site	82
5.5.2	Editing a Site	83
5.5.3	Deleting a Site	83
5.6	“Base Stations” Menu	83

---

5.6.1	Base Station States	84
5.6.2	OMM / RFP Software Version Check	85
5.6.3	Creating and Changing Base Stations	85
5.6.4	Capturing DECT Base Stations	88
5.6.5	Deleting DECT Base Stations	88
5.7	“DECT Phones” Menu	88
5.7.1	Creating and Changing DECT Phones	89
5.7.2	Importing DECT phone Configuration Files	91
5.7.3	Subscribing DECT Phones	92
5.7.4	Deleting DECT phones	93
5.7.5	Searching the DECT phone List	93
5.7.6	Displaying User and DECT Phone Data	94
5.8	“WLAN” Menu	98
5.8.1	“WLAN profiles” Menu	98
5.8.2	“WLAN clients” Menu	103
5.9	“System features” Menu	104
5.9.1	“Digit treatment” Menu	104
5.9.2	“Directory” Menu	106
5.9.3	“Directory (comp. mode)” menu	108
5.9.4	“Feature Access Codes” Menu	110
5.9.5	“XML Applications” Menu	111
5.10	“Licenses” Menu	112
5.11	“Info” Menu	113
<b>6</b>	<b>OM Management Portal (OMP)</b> .....	<b>114</b>
6.1	Login	114
6.2	Logout	115
6.3	OMP Main Window	115
6.4	“Status” Menu	117
6.4.1	Overview	117
6.4.2	DECT base stations	119
6.4.3	Users	120
6.4.4	Devices	121
6.4.5	Sites	122
6.4.6	Conference	122
6.4.7	Video Devices	123
6.5	“System” Menu	123
6.5.1	“Basic settings” Menu	124
6.5.2	“Advanced settings” Menu	127
6.5.3	“Statistics” Menu (Monitoring Mode Only)	140
6.5.4	“SIP” Menu	141
6.5.5	“Provisioning” Menu	150
6.5.6	“User administration” Menu	154
6.5.7	“Data management” Menu	157
6.5.8	“Event Log” Menu	162
6.6	“Sites” Menu	163
6.7	“DECT Base Stations” Menu	164
6.7.1	“Device list” Menu	164
6.7.2	“Paging areas” Menu	171
6.7.3	“Capturing” Menu	173
6.7.4	“Enrolment” Menu	173
6.7.5	“Export” Menu	174
6.7.6	“Sync view” Menu	175
6.7.7	“Statistics” Menu	176
6.7.8	“Quality” Menu	178
6.8	“WLAN” Menu	180
6.8.1	Profiles	180
6.9	“Video devices” Menu	183
6.9.1	Changing Video Devices	184
6.9.2	Viewing Video Device Details	184
6.9.3	Deleting Video Devices	184

---

6.9.4	Filtering Video Device Table	185
6.10	“DECT Phones” Menu	185
6.10.1	”Overview” Menu	186
6.10.2	“Users” Menu	188
6.10.3	“Devices” Menu	188
6.10.4	Device Detail Panel	189
6.10.5	Creating DECT phone Datasets	198
6.10.6	Configuring DECT phone Datasets	198
6.10.7	Subscribing DECT phone Datasets	199
6.10.8	Deleting DECT phone Datasets	199
6.10.9	Selecting Columns	199
6.10.10	Filtering DECT phone Table	199
6.10.11	Changing the Relation Type	200
6.10.12	Enabling / Disabling DECT phone Event Log	200
6.10.13	User Monitoring	201
6.11	“Conference rooms” Menu	202
6.11.1	Creating Conference Rooms	202
6.11.2	Configuring Conference Rooms	203
6.11.3	Deleting Conference Rooms	203
6.11.4	Viewing Conference Room Details	203
6.12	“System features” Menu	204
6.12.1	“General settings” Menu	204
6.12.2	“Feature access codes” Menu	205
6.12.3	“Alarm triggers” Menu	205
6.12.4	“Digit treatment” Menu	207
6.12.5	“Directory” Menu	208
6.12.6	“Directory (comp. mode)” Menu	211
6.12.7	“XML applications” Menu	214
6.12.8	“CoA Profiles” Menu	216
6.13	“License” Menu	217
6.14	“General” Menu	220
6.15	“Help” Menu	221
<b>7</b>	<b>Configuration and Administration .....</b>	<b>223</b>
7.1	IP Signaling and Media Stream	223
7.2	DECT Base Station Synchronization	225
7.2.1	Initial Synchronization Procedure	226
7.2.2	Checking the Synchronization of a Network	227
7.3	DECT Base Station Channel Capacity	227
7.4	Network Infrastructure Prerequisites	228
7.5	SIP-DECT Startup	228
7.5.1	TFTP and DHCP Server Requirements	228
7.5.2	Booting Steps	229
7.5.3	Booter Startup	230
7.5.4	Application Startup	232
7.5.5	RFP LED Status	235
7.6	State Graph of the Start-up Phases	238
7.7	Local DECT Base Station Configuration (OM Configurator)	240
7.7.1	Selecting the Network Interface	240
7.7.2	Adding DECT Base Stations for configuration	241
7.7.3	Scanning for DECT Base Stations	241
7.7.4	Adding DECT Base Stations manually	241
7.7.5	Loading DECT Base Station data from File	242
7.7.6	Editing DECT Base Station configuration data	242
7.7.7	Applying Configuration Changes	244
7.7.8	Factory Reset	245
7.7.9	Saving and Loading a DECT Base Station List	245
7.7.10	Removing DECT Base Station Entries	246
7.7.11	Compatibility with Older SIP-DECT Releases	246
7.8	OMM Configuration and Resource Files	246
7.8.1	Configuration File URL	247

---

---

7.8.2	Specific Configuration URLs	248
7.8.3	ReLoad of Configuration and Resource files	249
7.8.4	AXI Commands in Configuration Files	250
7.8.5	User Configuration Files	252
7.8.6	Digest Authentication and Certificate Validation	254
7.8.7	DECT base station software Image from RFP OMM	254
7.8.8	Redirection and Configuration Service (RCS)	255
7.8.9	Customer Logo on OMM Web Service	255
7.9	DECT Base Station Configuration Files	256
7.9.1	Standard IP settings	256
7.9.2	Configuration file source	256
7.9.3	Parameter settings priority	257
7.9.4	Software update settings for 3 <sup>rd</sup> generation DECT base stations	257
7.9.5	Times when RFP configuration times are read	257
7.9.6	RFP configuration file update check	258
7.9.7	Handling of parameter changes	259
7.9.8	Configuration file syntax	259
7.10	Consolidated Certificate management	261
7.10.1	SIP over TLS certificates	261
7.10.2	OMM Certificate (Web service / AXI)	261
7.10.3	Provisioning certificates	261
7.10.4	Certificate validation	262
7.11	RFP 35/36/37 IP / RFP 43 WLAN Software Update	262
7.12	802.1Q Support	262
7.12.1	Boot Phase of IP RFPs (DHCP)	263
7.12.2	Boot Phase of IP RFPs (Local Configuration)	264
7.13	Installing OMM in Host Mode	264
7.13.1	System Requirements	264
7.13.2	Installing the OMM Software	264
7.13.3	Configuring the Start Parameters	265
7.13.4	Specific Commands – Troubleshooting	266
7.14	Updating the OMM	266
7.14.1	Updating a Single OMM Installation	267
7.14.2	Updating a Standby OMM Installation	267
7.15	OMM Standby	269
7.15.1	Configuring OMM Standby	269
7.15.2	Fail Over Situations	269
7.15.3	Failover Failure Situations	270
7.15.4	Specific standby situations	271
7.16	User data synchronization (MiVoice 5000 dual homing support)	272
7.16.1	Roaming	273
7.16.2	Setting up user data synchronization	274
7.16.3	User data synchronization modes	275
7.17	Managing Account Data for System Access	277
7.17.1	Account Types	277
7.17.2	Potential Pitfalls	278
7.18	WLAN Configuration (RFP 42 WLAN / RFP 43 WLAN only)	278
7.18.1	WLAN configuration steps	278
7.18.2	Optimizing the WLAN	279
7.18.3	Securing the WLAN	281
7.19	SNMP Configuration	281
7.20	Backup SIP Proxy/Registrar	282
7.20.1	REGISTER Redirect	282
7.20.2	DNS SRV	282
7.20.3	Backup SIP Servers	284
7.20.4	Keep Alive Mechanism	286
7.20.5	Prioritized Registration	286
7.20.6	Monitoring the SIP Registration Status	287
7.20.7	Configurable User Account for Standby Check	287
7.20.8	OMM Standby Enhancement	287
7.21	Conferencing	288

---

7.21.1	Centralized Conferencing	289
7.21.2	Integrated Conference Server (ICS)	289
7.21.3	Configure conference rooms	291
7.22	Download Over Air	294
7.22.1	How “Download Over Air” Works	294
7.22.2	How to configure “Download Over Air”	295
7.23	Central DECT Phone Configuration Over Air (CoA)	297
7.23.1	Configuration files	297
7.23.2	Configuration file download to DECT phones	298
7.23.3	CoA Configuration using OMP	299
7.23.4	Configuration using usr_common.cfg/<user>/cfg Files	299
7.23.5	Variable lists	300
7.24	Extended DECT Phone Interface	305
7.25	OMM/DECT Phone Lock with Branding ID	306
7.25.1	Subscribing the DECT Phone	306
7.26	Device Placement	307
7.26.1	“Placement” View	307
7.26.2	“DECT Base Stations” View	308
7.26.3	“Image management” View	308
7.27	Monitoring with USB Video Devices	310
7.27.1	Configuration of a video user account	311
7.27.2	Configuration of USB video devices	311
7.27.3	Monitoring with USB video devices	311
7.28	Terminal Video	312
7.28.1	Technical Details	312
7.28.2	OMP Configuration Steps	312
7.28.3	Camera Selection via DECT phone Menu	313
7.29	User Monitoring	313
7.29.1	Overview	313
7.29.2	Status Attributes and Validation Mechanisms	315
7.29.3	Escalation	318
7.29.4	Alarm Triggers	318
7.29.5	OM Locating Application	318
7.29.6	Licensing and System Capacities	319
7.29.7	Configuration	319
7.29.8	Start and Failover	321
7.29.9	Supported DECT phones	321
7.29.10	Restrictions	322
7.30	S RTP	323
7.31	SIP over TLS	323
7.31.1	Certificates	324
7.31.2	Private Key	325
7.31.3	TLS Transport Mode	326
7.31.4	Verification of Remote Certificates	326
7.31.5	Additional Security Considerations	327
7.32	DECT Enhanced Security	327
7.33	Migration of RFP SL35 IP from SIP-DECT Lite 3.1 to SIP-DECT 6.1	328
<b>8</b>	<b>Maintenance .....</b>	<b>329</b>
8.1	Site Survey Measurement Equipment	329
8.2	Checking the Mitel Handset Firmware Version	329
8.3	Diagnostic	329
8.3.1	Mitel DECT Phone Site Survey Mode	329
8.3.2	Mitel Handset Auto Call Test Mode	330
8.3.3	Mitel Handset Auto Answer Test Mode	330
8.3.4	Syslog	331
8.3.5	SSH user shell	332
8.3.6	Core File Capturing	336
8.3.7	DECT Monitor	337
<b>9</b>	<b>Safety Information .....</b>	<b>341</b>



---

9.1	CE Marking	341
9.2	Communications Regulation Information	341
9.2.1	FCC Notices (U.S. Only)	341
9.3	Health and Safety	342
9.3.1	Exposure to Radio Frequency (RF) Signals:	342
9.3.2	Industry Canada (Canada only)	342
9.4	Informations réglementaires en matière de communications	342
9.4.1	Notes FCC (USA uniquement)	343
9.5	Santé et sécurité	343
9.5.1	Exposition aux signaux radio (RF)	343
9.5.2	Industrie Canada (Canada uniquement)	343
<b>10</b>	<b>Appendix .....</b>	<b>345</b>
10.1	Pre-Configuration File Rules	345
10.1.1	DECT phone Configuration File (OMM Database)	345
10.2	RFP Configuration File / Central (OMM Database)	349
10.2.2	RFP Configuration File / Local (OM Configurator)	352
10.3	RFP Export File Format	356
10.4	COA Configuration Parameters	357
10.4.1	Extended COA example	357
10.4.2	Supported CoA Parameters	361
10.5	Protocols and Ports	380
10.6	Abbreviations	382
10.7	Definitions	383
10.8	References	385

# 1 OVERVIEW

This document describes the installation / configuration, administration, and maintenance of the SIP-DECT solution. Please also see the documents listed in the References section (section 10.8) for additional details on different aspects of the SIP-DECT system.

For a list of abbreviations and definitions, see the appropriate sections in the Safety Information.

## 1.1 THE SIP-DECT SOLUTION

The SIP-DECT solution includes the following main components:

- SIP-DECT base stations that are distributed over an IP network and offer DECT, WLAN, and IP interfaces
- DECT phones (portable DECT devices)
- OpenMobility Manager (OMM): Management and signaling software for the SIP-DECT solution, which runs on one of the DECT base stations or on a dedicated Linux server (for large installations). In addition, a standby OMM can be configured to ensure OMM function in case of failure or loss of network connection.
- A SIP Call Manager/IP PBX/Media Server platform (e.g. Asterisk)

The IP PBX/media server/media gateway, OMM and the RFPs communicate through the IP infrastructure. The RFPs and the DECT phones communicate over the air, where the DECT GAP protocol or DECT GAP with proprietary enhancements is used.

The SIP-DECT solution supports seamless handover between RFPs which are in a group of synchronized RFPs (cluster) and roaming between RFPs on remote sites.

Additional components include:

- LDAP server to facilitate a central corporate directory
- Provisioning server to provide RFP configuration or user data files
- Data backup server to automatically backup an OMM database from the server
- OM Locating server and clients to run the SIP-DECT locating solution
- 3<sup>rd</sup> party messaging or alarm server to integrate the SIP-DECT text messaging into a unified messaging or alarm environment
- Computer for administration and maintenance tools: Web browser, OM Management Portal (OMP), DECT Monitor

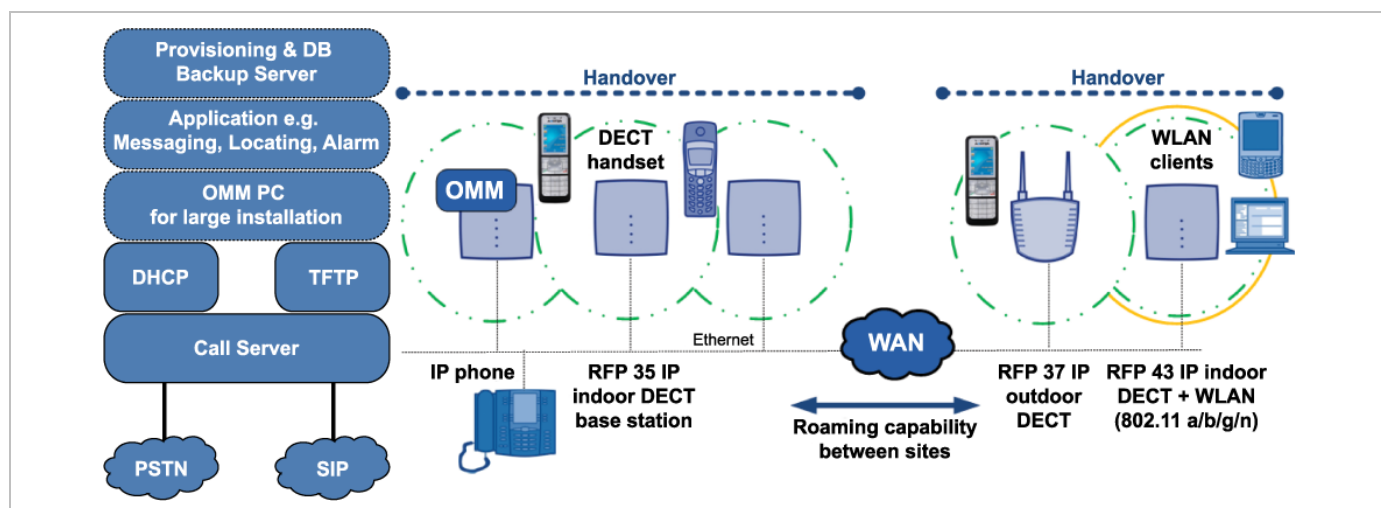

## 1.2 ABOUT DECT BASE STATIONS

DECT base stations are also referred to as Radio Fixed Parts (RFPs) in this document.

### 1.2.1 DECT BASE STATION FAMILIES

#### 1.2.1.1 Current DECT Base Station Types

Mitel offers four types of DECT base stations for the SIP-DECT solution:

- RFP 35 IP  
DECT RFP as indoor model
- RFP 36 IP  
DECT RFP as outdoor model with built-in dipole antennas
- RFP 37 IP  
DECT RFP as outdoor model with connectors for external directional antennas
- RFP 37 DRC (Set)  
DECT RFP, preinstalled with directional antennas and 3m cable in an outdoor enclosure
- RFP 43 WLAN  
DECT RFP + WLAN Access Point as indoor model with internal antennas for DECT and WLAN

As of SIP-DECT 6.0, there is no distinction between DECT base station soft brands (i.e., L-RFPs and non-L-RFPs). See section 3.32 for more information.

In general the RFP 35 / 36 / 37 IP have the same hardware platform and software capabilities. RFP 43 supports WLAN in addition to DECT.

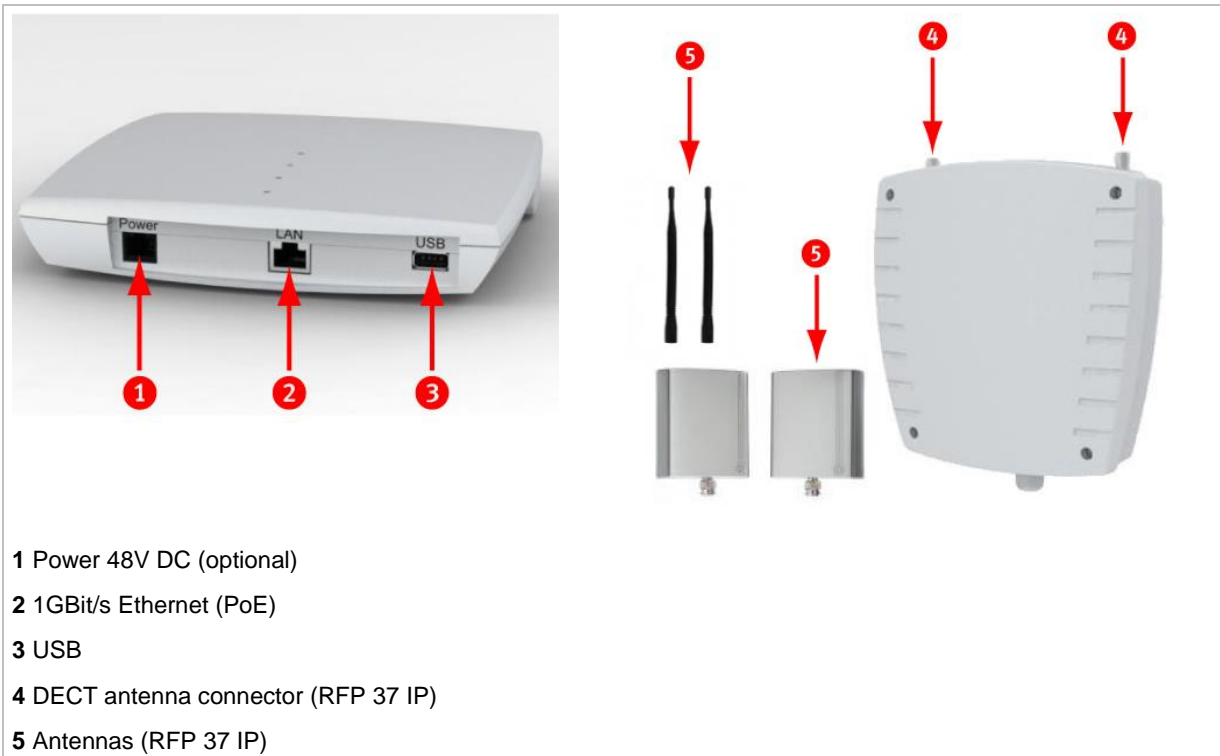

The hardware of all the new RFPs complies with the different regulatory domains. There are no specific hardware variants required to use specific frequency bands and field strengths. Transmit Power, frequency band and carrier frequencies are controlled by software.

Other differences compared to the previous RFP family (RFP 32/34 IP and RFP 42 WLAN):

- boots from internal flash memory instead of net-boot (SIP-DECT software is already on board)
- software update via TFTP, FTP(S), HTTP(S), SFTP supported
- supports 1Gbit/s Ethernet
- supports CAT-iq 1.0 level high definition voice for the Mitel 650 DECT phone
- hardware can support Secure SIP and SRTP (with SIP-DECT 5.0 or later)
- uses an external 48V DC Power Supply (if no PoE available) which meets the latest environmental requirements (RFP 37: PoE only)
- RFP 43 WLAN supports the 802.11a/b/g/n standards
- any 3G RFP can host the OMM.
- indoor RFPs have a USB 2.0 interface to connect external hardware for future applications (e.g., video camera).

### 1.2.1.2 Older RFP Types

Older RFP models supported by the SIP-DECT solution include

- RFP 32 IP  
DECT RFP as indoor model
- RFP 34 IP  
DECT RFP as outdoor model
- RFP 42 WLAN  
DECT RFP + WLAN Access Point as indoor model

The RFP 32 and RFP 34 have the same hardware and software capabilities. Please note the regulatory differences between North America and other areas of the world. These differences lead to different RFP 32/34 variants which use specific frequency bands and field strengths:

- RFP 32 NA or RFP 34 NA (NA)
  - Frequency Band 1920 to 1930 MHz
  - 5 carrier frequencies
  - Transmit Power 20 dBm
- RFP 32 IP or RFP 34 IP (EMEA)
  - Frequency Band 1880 to 1900 MHz
  - 10 carrier frequencies
  - Transmit Power 24 dBm

The RFP 42 WLAN is only available for the EMEA region.

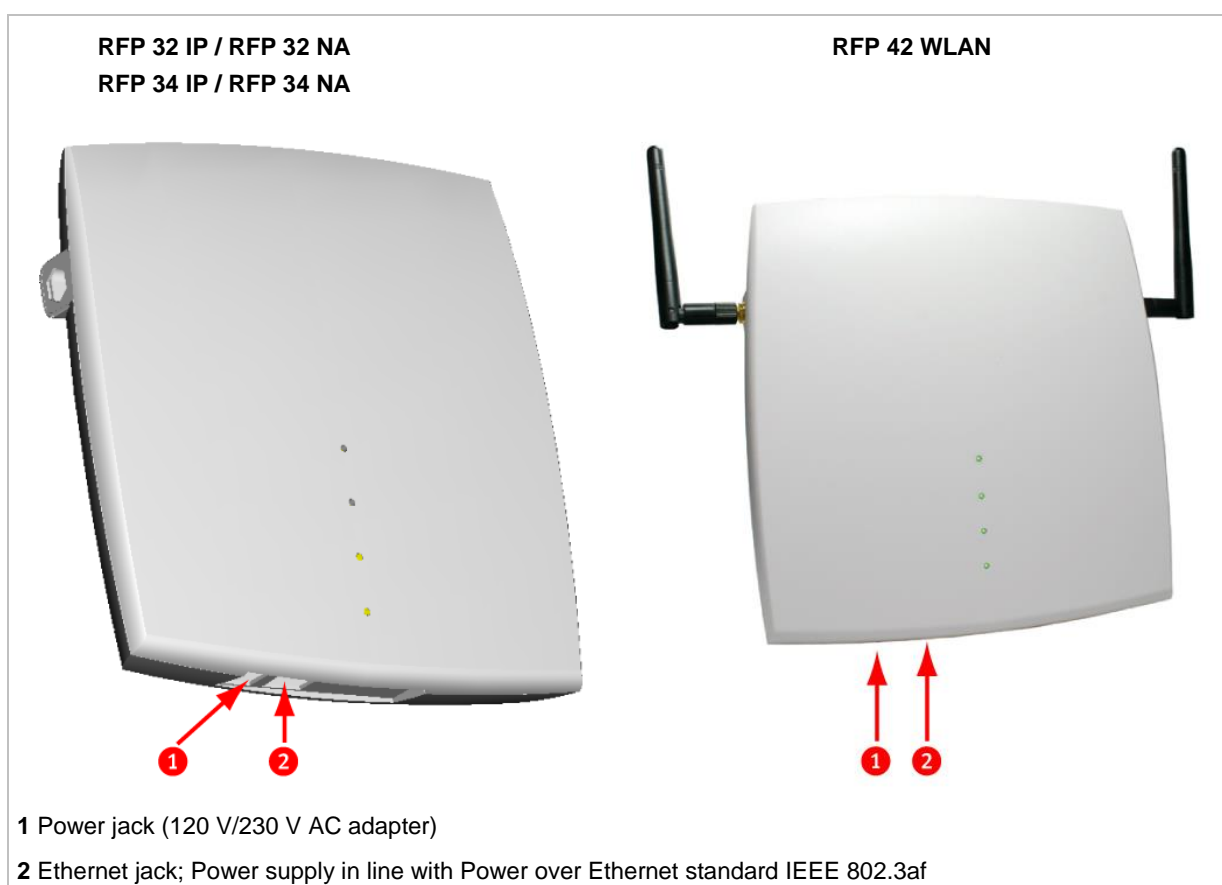

As of SIP-DECT 6.0, there is no distinction between RFP soft brands (i.e., L-RFPs and non-L-RFPs). With SIP-DECT 5.0 and older releases, the “L” variants have built-in licenses. See section 3.32 (Licensing) for more information.

**Note:** The software package for previous RFPs has a tftp extension e.g. “iprfp2G.tftp”. With SIP-DECT 3.0 or higher, you need a 3G RFP to run the Open Mobility Manager.

## 1.2.2 RFP ONLY MODE

Within this mode the RFP converts IP protocol to DECT protocol and then transmits the traffic to and from the DECT phones over a DECT time slot. On air the RFP has 12 available time slots, 8 can have associated DSP/media resources for media streams. All DECT time slots are used for control signaling, software download over air, messaging and bearer handover independent of associated DSP/media resources.

Two control signaling channels are also used to carry bearer signals that signal the DECT phone to start the handover process. If the radio signal of another RFP is stronger than that of the current RFP, the DECT phone starts the handover process to the RFP that has the stronger signal as the user moves around the site.

### Clusters

Groups of RFPs can be built which are named clusters. Within a cluster RFPs are synchronized to enable a seamless handover when a DECT phone crosses from one RFP's area of coverage to another. For synchronization, it is not necessary for an RFP to have direct line of sight to all other RFPs in the system. Each RFP only needs to be able to see the next adjacent RFP. But it is highly recommended that an RFP have visibility to more than one RFP to guarantee synchronization in the event that one of the RFPs fails.

## 1.2.3 OPENMOBILITY MANAGER (OMM) MODE

If the OMM is not running on a dedicated Linux server, one RFP within a SIP-DECT installation must be declared to operate as the OpenMobility Manager (OMM). The RFP acting as the OMM may also act as a regular RFP if it is part of a DECT cluster.

In OMM mode, an RFP functions as a regular RFP. Additionally, it is responsible for SIP signaling between the SIP-DECT system and the IP PBX/SIP server. Further on, it takes over the management part of the SIP-DECT solution. You designate an RFP as the OMM by assigning an IP address to the RFP within the DHCP scope (see section 7.5) or by setting the data via the OM Configurator (see section 7.7). After an RFP is designated as the OMM, it starts the extra services on board (for example, the web service that supports the management interface). All RFPs download the same firmware (for their RFP type), but only one RFP (or two, in standby implementations) activates the OMM services.

**Note:** It is possible to deactivate the DECT part of an RFP. If the DECT interface is deactivated, all resources (CPU and memory) are available for the OMM.

This might be necessary, for example, in configurations where a mix of OpenMobility Manager, G.729/Conferencing and WLAN is provided by the same RFP.

## 1.3 ABOUT THE OPENMOBILITY MANAGER

The OpenMobility Manager (OMM) requires an RFP 35/36/37 IP resp. RFP 43 WLAN, or a dedicated Linux server.

There is only one OpenMobility Manager (OMM) active in the system at a given time.

- If the OMM runs on a DECT base station, a 100 Mbit/s network link is required.
- If the OMM runs on a dedicated Linux server, a 1 GBit/s network link is required (see also section 7.13.1).

In addition, a standby OMM can be configured to ensure the OMM function in case of failure or loss of network connection. For more information on the standby OMM see section 7.15.

### 1.3.1 OMM TASKS

The OMM performs the following tasks:

- Signaling gateway (SIP <-> DECT)
- Media stream management
- Managing sync-over-air functions between RFPs
- Provides a Web service for system configuration
- Provides additional services such as
  - LDAP based central corporate directory
  - OM Application XML interface (OM AXI) for OAM&P, messaging, alerting service and locating
  - Integrated Messaging and Alerting Service (OM IMA)
  - Data backup and provisioning services
  - SIP-DECT XML terminal interface. This interface adapts the “XML API for SIP Phones” to SIP-DECT phones. The Mitel 600 DECT phone family is supported.

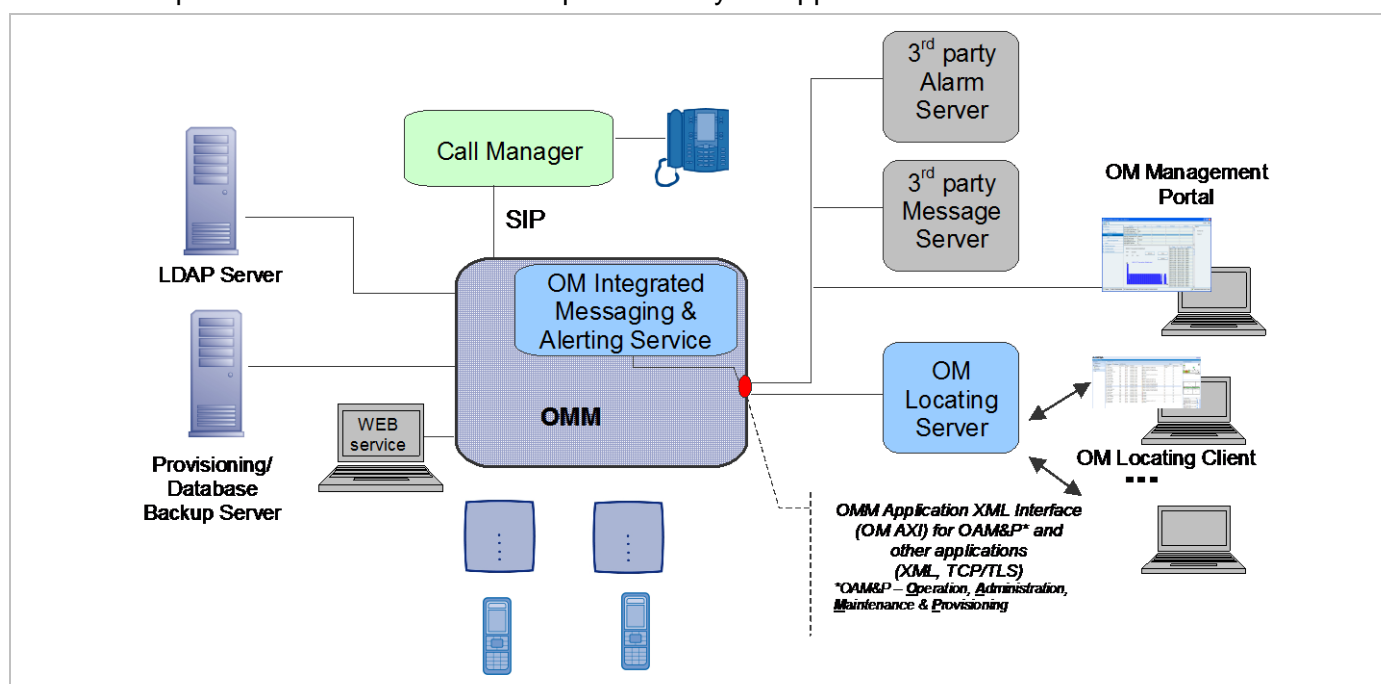

Additional information on the following functionality is available in separate documents.

- **Locating**: see the SIP-DECT OM Locating Application Installation and Administration Guide.
- **Integrated Messaging and Alerting Service**: see the *SIP-DECT OM Integrated Messaging and Alerting Application Guide* and the *SIP-DECT Mitel 600 Messaging and Alerting Applications Guide*.
- **User data provisioning**: see the SIP-DECT OM Handset Sharing and Provisioning Guide.
- Administration and monitoring by third party applications: see the *OM Application XML Interface Specification*.
- SIP-DECT XML terminal interface: see the *SIP-DECT XML Terminal Interface Specification*.

### 1.3.2 SIP-DECT SPECIAL FEATURES AND CAPABILITIES

Feature	GAP	142d	600
Large DECT Systems (XXL)	No connection handover beyond 256 RFPs	yes	yes
Messaging & Alerting	no	no	yes
Initiate Alarm Trigger	*, # feature access code procedure, no sensor alarm	*, # feature access code procedure, no sensor alarm	yes
Locating	yes	yes	yes
DECT XQ	no	no	yes
UTF-8 and alphanumeric dialing support	no	no	yes
SIP-DECT XML terminal API	no	no	yes
CAT-iq 1.0 / Hi-Q™ audio technology	no	no	yes (650 only)

### 1.3.3 OMM CAPACITIES AND FEATURES

The following table summarizes OMM capabilities:

Feature	Release 3.0 or later		Release 6.0 or later	
	RFP OMM	Linux server OMM	RFP OMM	Linux server OMM
RFP 32/34 IP and RFP 42 WLAN	256 <sup>1</sup>	2048 <sup>1</sup>	256 <sup>1</sup>	4096 <sup>1</sup>
RFP 35/36/37 IP and RFP 43 WLAN	256 <sup>1</sup>	2048 <sup>1</sup>	256 <sup>1</sup>	4096 <sup>1</sup>
Handsets / users	512	4500	512	10000
Message / Alarm receive	yes / yes <sup>1</sup>	yes / yes <sup>1</sup>	yes / yes <sup>1</sup>	yes / yes <sup>1</sup>
Message send	yes	yes	yes	yes
Locating	yes <sup>1</sup>	yes <sup>1</sup>	yes <sup>1</sup>	yes <sup>1</sup>
DECT XQ	yes	yes	yes	yes
UTF-8 and alphanumeric dialing support	yes	yes	yes	yes
SIP-DECT XML terminal API	yes	yes	yes	yes
CAT-iq 1.0 / Hi-Q™ audio technology	yes <sup>2</sup>	yes <sup>2</sup>	yes <sup>2</sup>	yes <sup>2</sup>

<sup>1</sup> The feature requires a license.

<sup>2</sup> The feature is available with the RFP 35/36/37 IP and RFP 43 WLAN and the Mitel 650 DECT phone (or other CAT-iq-capable devices). The feature is enabled per site and requires that the RFPs are configured in the same site and cluster.



## 1.4 ABOUT DECT PHONES

DECT Phones (formerly referred to as Portable Parts) are an integral part of the SIP-DECT solution.

Mitel provides the following DECT phones:

- Mitel 142 DECT Phone
- Mitel 600 DECT Phone series
  - Mitel 612 DECT Phone
  - Mitel 622 DECT Phone
  - Mitel 632 DECT Phone
  - Mitel 650 DECT Phone

### Notes on the Mitel 600 DECT Phones

The Mitel 600 DECT phones support both the NA and EMEA regulatory requirements.

The latest Mitel 600 firmware release has the following characteristics:

- New user interface e.g. new dial editor with alphanumerical and always en-bloc dialing
- Support of UTF-8 in over the air signaling with the OMM
- Digit and alphanumeric dialing
- Support of SIP-DECT XML terminal interface
- Support of microSD card to save subscription data and the most important local device data (not supported by Mitel 600 DECT phones)
- Additional subscription options
- Additional alarm melodies
- Profile indication in idle display

For more details please see /31/and /32/.

In addition to the existing Mitel 600 DECT phone set, the new Mitel 650 DECT phone supports CAT-iq 1.0 and thus supports G.722 (wideband) voice connections. For the full experience of wideband audio, the DECT phone hardware (e.g., speakers, microphone, and processor) has been improved.

The Mitel 600 DECT phone also supports DECT enhanced security.

## 1.5 FILE NAMING CONVENTIONS

The following table lists the file names for SIP-DECT software deliverables.

Software package	Old (Rel. 2.1 or earlier)	New
Software image for RFP 32/34 IP / RFP 42 WLAN	omm_ffsip.tftp	iprfp2G.tftp
Software image for RFP 35/36/37 IP / RFP 43 WLAN	-	iprfp3G.dnld
OMM software for Linux Red Hat server (self-extracting executable)	omm_ffsip_install.bin	SIP-DECT_<version>.bin
SIP-DECT OMM software rpm	omm_ffsip-OMM- <ommversion>.i586.rpm	SIP-DECT-OMM- <version>.i586.rpm
SIP-DECT DECT phone firmware rpm	omm_ffsip-6xxd-<DECT phoneversion>.i586.rpm	SIP-DECT-HANDSET- <version>.i586.rpm

## 1.6 LOGIN AND PASSWORDS

The following table summarizes the default login and passwords for SIP-DECT system components.

<b>Interface/Tool</b>	<b>OMM</b>	<b>RFP 32/34 IP / RFP 42 WLAN</b>	<b>RFP 35/36/37 IP / RFP 43 WLAN</b>
Initial configuration via OM Configurator login / password (no previous connection with the OMM)	n/a	No login required	"omm" / "omm"
Initial OMM configuration via Web or OMP standard full-access account login / password	"omm" / "omm"	n/a	n/a
OMM access via Web or OMP (after initial OMM configuration)	Read-only or full-access accounts as configured	n/a	n/a
Configuration via OM Configurator after connection with OMM login / password (system-wide set by OMM)	n/a	OMM standard full-access account login / password	OMM standard full-access account login / password
ssh (no previous connection with the OMM)	n/a	User shell: "omm" / "omm" Root shell: "root" / "22222"	User shell: "omm" / "omm" Root shell: "root" / "22222"
ssh (with previous connection with the OMM) (system-wide set by OMM)	n/a	User shell: OMM standard full-access account login / password Root shell: as configured	User shell: OMM standard full-access account login / password Root shell: as configured

## 2 GETTING STARTED

The following example describes the steps required for a minimal SIP-DECT configuration.

### 2.1 BASE STATION STARTUP CONFIGURATION

Start up information for each DECT base station needs to be provided by DHCP or OM Configurator. To use DHCP, specific vendor options must be configured in the DHCP Server for SIP-DECT (see section 7.5.4.1).

In this example, the OM Configurator is used to provide a static IP Configuration to the RFPs.

- 1 Connect the DECT base station(s) to your LAN and power up the units.
- 2 Open the OM Configurator and select your network interface via the **General** -> **Options** menu.
- 3 Click **Scan** to find the base stations connected to your LAN (enter user name and password: "omm" / "omm" for initial configuration until start-up)
- 4 Select a base station entry and double-click for configuration.
- 5 Enter the configuration parameters for the base station. For configuration details, see section 7.7.
- 6 Click **OK** when you have entered configuration parameters.
- 7 Click **Send Configuration** to apply the configuration to the DECT base station.
- 8 To configure the next unit, select another base station entry from the table, set the appropriate parameters (and confirm with **OK**), and click **Send Configuration**.

**Note:** The OM Configurator requires the Java Runtime Environment version 1.7 or higher.

### 2.2 SYSTEM CONFIGURATION

As soon as the OMM starts up, open a browser and connect ([https://<IP\\_address>](https://<IP_address>)). Login with the user: omm and password: omm for the initial configuration.

The OMM forces you to change the login, which then also applies to the OM Configurator.

The OMM Web service provides basic parameters to setup the system, which is sufficient for this example scenario. To configure the OMM in detail, use the OM Management Portal (OMP). This application requires a current Java 1.7 to run and supports detailed OMM configuration and monitoring. The OMM Web service provides a link to run the OMP application via Java Web start.

## 2.3 SYSTEM SETTINGS

The OMM System settings menu provides the basic settings to operate the SIP-DECT system.

General settings	
System name	<input type="text" value="Customer"/>
Remote access	<input checked="" type="checkbox"/>
Tone scheme	<input type="text" value="US"/>

DECT settings	
PARK	<input type="text" value="1F102643C7"/>
DECT power limit 100mW	<input type="checkbox"/>
Encryption	<input type="checkbox"/>
Restrict subscription duration	<input type="checkbox"/>
DECT monitor	<input type="checkbox"/>
Regulatory domain	<input type="text" value="US (FCC/IC)"/>
DECT authentication code	<input type="text" value="2222"/>
DECT phone user login type	<input type="text" value="Number"/>
Preserve user device relation at DB restore	<input type="checkbox"/>

Voice mail	
Voice mail number	<input type="text" value="25711"/>

**System name:** Customer Name

**Remote access:** allow SSH access

**Tone Scheme:** scheme to simulate call control tones (country-dependent).

**PARK:** The system needs a PARK code to operate. Use the Online PARK service to obtain a PARK code (see section 4.1.3) (five or more RFP systems).

**Regulatory domain:** DECT regulatory domain applicable to your local region.

**DECT authentication code:** define as template for the subscription of new DECT phones.

**Voice mail number:** your system voicemail number. A Mitel 600 phone will then offer the voice box in the Handset menu.

## 2.4 BASE STATIONS

Configure all base stations (formerly referred to as Radio Fixed Parts) from the **Base Stations** menu (including the OMM DECT base stations).

When you click on the **Start** button below the “Capturing unconfigured DECT base stations” caption, the OMM lists all DECT base stations trying to connect.

Click on **New** to configure a new base station.

### New base station

 Please configure a WLAN profile of proper type.





General settings	
MAC address	<input type="text"/>
Name	<input type="text"/>
Site	1 ▼
<input type="checkbox"/>	<b>DECT settings</b>
DECT Cluster	1
Preferred synchronization source	<input type="checkbox"/>
Reflective environment	<input type="checkbox"/>
<input type="checkbox"/>	<b>WLAN settings</b>
WLAN profile	1 ▼
802.11 channel	▼
Output power level	Full ▼

OK Cancel

The base station configuration requires:

- base station MAC address
- Name e.g. location
- Site (default: 1)
- DECT active
- DECT cluster (default: 1)

The Status for each DECT base station is shown in the **Base Stations** section.

- **Active:** DECT Radio State (Active , Searching , Off , disabled  / - )
- **Connected:** DECT base station is connected to the OMM, DECT base station must be configured first.

## 2.5 SIP SETTINGS

Configure the SIP connection to the call server that the OMM must connect to in the OMM **System** -> **SIP** menu. Make sure the **Advanced** checkbox in the top bar is enabled.

The SIP user account (SIP-ID, Auth, and password) configuration is part of the DECT Phones configuration.

The default SIP signaling port for SIP-DECT is 5060 / UDP. Change if this is required by the SIP Server.

### SIP

<input type="button" value="OK"/> <input type="button" value="Cancel"/>	
<b>Basic settings</b>	
Proxy server	<input type="text" value="10.37.44.99"/>
Proxy port	<input type="text" value="5060"/>
Registrar server	<input type="text" value="10.37.44.99"/>
Registrar port	<input type="text" value="5060"/>
Registration period	<input type="text" value="300"/> sec
Globally Routable User-Agent URL	<input checked="" type="checkbox"/>
Outbound proxy server	<input type="text"/>
Outbound proxy port	<input type="text" value="5060"/>
Transport protocol	<input type="text" value="UDP"/>
Local UDP/TCP port range	<input type="text" value="5060"/> - <input type="text" value="5060"/>
Local TLS port range	<input type="text" value="5061"/> - <input type="text" value="5061"/>

Enter values for the following:

- **Proxy Server** : PBX IP or DNS Name
- **Proxy Port**: 5060
- **Registration Server**: PBX IP or DNS Name
- **Registration Port**: 5060

<b>RTP settings</b>	
RTP port base	<input type="text" value="16320"/>
Preferred codec 1	<input type="text" value="G.711 u-law"/>
Preferred codec 2	<input type="text" value="G.711 A-law"/>
Preferred codec 3	<input type="text" value="G.729 A"/>
Preferred codec 4	<input type="text" value="G.722"/>
Preferred packet time	<input type="text" value="10"/> msec
Silence suppression	<input type="checkbox"/>
Receiver precedence on codec negotiation	<input type="checkbox"/>
Eliminate comfort noise packets	<input type="checkbox"/>
Single codec reply in SDP	<input type="checkbox"/>
<b>DTMF settings</b>	
Out-of-band	<input checked="" type="checkbox"/>
Method	<input type="text" value="RTP(RFC 2833)"/>
Payload type	<input type="text" value="101"/>

Use the default RTP settings unless your installation requires a different configuration.

Use the default DTMF settings unless your installation requires a different configuration.

## 2.6 DECT PHONES

SIP-DECT allows multiple configuration and provisioning methods for DECT phones. In this example we use fixed DECT phones. A SIP-extension must be configured for each DECT phone (user) on the SIP call server.

To add a new DECT phone, go to the **DECT Phones** menu (ensure the **Advanced** option in the top bar is enabled) and click **New**.

### New DECT phone

General settings	
Display name	<input type="text"/>
Number/SIP user name	<input type="text"/>
IPEI	<input type="text"/>
DECT authentication code	<input type="text" value="2222"/>
Login/Additional ID	<input type="text"/>
SOS number	<input type="text"/>
ManDown number	<input type="text"/>
Voice mail number	<input type="text"/>
Number used for visibility checks	<input type="checkbox"/>
SIP authentication	
Authentication user name	<input type="text"/>
Password	<input type="text"/>
Password confirmation	<input type="text"/>

Subscription with configured IPEIs

Wildcard subscription

Enter values for the following:

**Display name:** Extension Name

**Number/SIP user name:** SIP-ID e.g. terminal phone number

**IPEI:** Handset hardware identifier (optional)

**DECT authentication code:** Code for Handset subscription. If this field is left empty, the system-wide DECT authentication code is used (see section 2.3).

**Authentication user name:** SIP user name

**Password:** SIP Extension password

To subscribe new DECT phones, subscriptions must = be permitted by the OMM.

Use **Wildcard subscription** if no IPEI is set.

To subscribe new Mitel 600 DECT phones, open the DECT phone **System > Subscriptions** menu. Select **New system** and enter the Authentication code provided in your System Settings (e.g. 123456). The DECT phone prompts you to enter a PARK or to proceed with the subscription without a PARK. Set the PARK if several DECT systems are around, otherwise the DECT phone tries to subscribe to the first available DECT system.

### 2.6.1 DECT PHONE AND SIP STATE VERIFICATION

You can check the DECT phone state and SIP registration status from the **DECT Phones** page.

Click on the magnifying glass icon beside the entry for the DECT phone you just created to view details on the SIP registration status.

The screenshot displays a web interface for user configuration. It is titled "User/device status & configuration" and is divided into three main sections: "User status:", "User configuration data:", and "Login/Add ID:". Each section contains a list of key-value pairs for various parameters.

User status:	
Registered:	Yes
Registrar server type:	Primary
Registrar server:	10.37.44.99
Registrar port:	5060
Calculated local port:	5060
Silent charging:	No
CoA data loaded:	No

User configuration data:	
User ID:	2
User rel. type:	Fixed
Name:	x25053 622d
Number:	25053
Description 1:	
Description 2:	
User lang.:	English
SOS number:	
MD number:	
VM number:	
SIP auth. user name:	25053
SIP auth. password:	*****
Fixed local port:	

Login/Add ID:	
PIN:	*****
External:	No
VIP:	Yes
Visibility checks:	No
Sending messages:	No
Sending vCards:	No
Receiving vCards:	No
Video stream perm.:	No

Switch the DECT phone off / on to force SIP user registrations.



## 3 ENHANCED FEATURE OVERVIEW

A SIP-DECT system can scale from a small system of five or less DECT base stations to a larger SIP-DECT system that may include hundreds of DECT base stations. Some of the more advanced features target larger DECT systems. You may browse the following list of features in order to get an overview and to decide if it's relevant for your requirements. You find in-depth explanations in the referenced sections.

**Please note:** Be aware that the majority of the new enhanced features require the current DECT phone firmware release. It is assumed that SIP-DECT installations are configured to perform an automatic firmware update over the air.

### 3.1 PC-BASED OMM INSTALLATION

A very large number of DECT base stations or a large number of DECT phones may exceed the storage capacity or processing power of the embedded DECT base station. For this reason, it is also possible to operate the OMM on a standard PC under the Linux operating system (see section 7.12).

As of SIP-DECT 5.0, CentOS 6 and virtualized environments (VMware vSphere ESXI 5 and 6) are also supported. SIP-DECT 6.1 has been tested with CentOS 6.x.

### 3.2 DECT XQ

The DECT radio communication generally suffers from attenuation and radio wave reflection. In particular, if a building's walls and ceilings contain a higher portion of metal-based material or if larger metal surfaces are present, the DECT XQ improves the radio communication between a DECT base station and a Mitel 600 DECT phone at the expense of DECT channel capacity (see 7.3). Enable this feature for some or all of your DECT base stations (see section 5.6.3, "DECT settings" or section 6.7.1.2, "DECT tab").

DECT XQ audio cannot be combined with Hi-Q audio within the same connection.

There are three operating modes related to audio quality available on the Mitel 650 DECT phone: standard audio, Hi-Q audio and automatic.

- In Hi-Q audio mode, a Mitel 650 DECT phone exclusively establishes wideband connections and does not switch to narrowband later. A Mitel 650 in this mode ignores the XQ capability of the RFP.
- In standard audio mode, a Mitel 650 DECT phone exclusively establishes narrowband connections and does not switch to wideband later. A Mitel 650 in this mode will switch to DECT XQ and back as necessary.
- In automatic mode, the connection establishment depends on whether the current base provides DECT XQ or not. If DECT XQ is available, a narrowband connection will be established. Otherwise a wideband connection will be established.

### 3.3 WIDEBAND (CAT-IQ 1.0 / MITEL HI-Q™ AUDIO TECHNOLOGY)

In conjunction with the RFP 35/36/37 IP and RFP 43 WLAN, the Mitel 650 DECT phone can act as a Mitel Hi-Q audio terminal. This feature is realized using wideband speech according to CAT-iq.

Each Hi-Q connection uses twice the capacity on the DECT air interface, as compared to conventional narrowband. Therefore, four Hi-Q connections can be established via one RFP, instead of eight narrowband calls.

Mitel Hi-Q audio technology must be enabled or disabled per site (see section 5.5). This functionality must be homogeneously available among synchronous RFPs (members of the same cluster). Each site with enabled Hi-Q audio must exclusively contain new RFP 35/36/37 IP or RFP 43 WLAN.

Typically one site is identical with one cluster, i.e. all RFPs belonging to a specific site belong to a specific cluster. However a site can have more than one cluster. The OMM allows configuration of a cluster that contains multiple sites. Such configuration could annul the rule that Hi-Q audio must be homogeneously available among synchronous RFPs.

**Please note:** It is strongly recommended not to setup systems with multiple sites within one cluster.

### 3.4 DECT ENHANCED SECURITY

In response to market concerns, the DECT standard has introduced improvements to security. Many security features, which were specified in the DECT standard (respectively GAP) were left optional for the DECT phones. These mechanisms became mandatory with CAT-iq. Almost all of this functionality was present and used within SIP-DECT right from the start.

Furthermore, some new features have been added to GAP:

- encryption of all calls (not only voice calls)
- re-keying during a call
- early encryption

Each feature provides an additional security guarantee and is therefore an integral part of the SIP-DECT solution.

The feature set can be enabled or disabled per site, because enhanced security is available with RFPs 35/36/37/43. Roaming between sites where enhanced security is enabled and disabled respectively should be avoided.

With SIP-DECT 5.0 and later, when DECT enhanced security is enabled, every connection is encrypted – not only voice calls, but also service calls (e.g. list access) or messaging.

Additionally, the cipher key used for encryption during an ongoing call is changed every 60 seconds.

Finally, every connection is encrypted immediately upon establishment to protect the early stages of the signaling such as dialing or CLIP information.

DECT enhanced security is only supported with Mitel 602 DECT phones. Older terminals (e.g. 6x0d or 142d) or GAP phones still operate as normal, but do not support the new security mechanisms.

## 3.5 VOIP ENCRYPTION

To allow secured call connections over unsecured IP infrastructures (e.g. internet), SIP-DECT supports SRTP to encrypt the RTP voice streams and TLS to encrypt the SIP signaling.

These security mechanisms, together with a secured iPBX infrastructure, allow protected call services and ensure:

- authentication
- integrity
- confidentiality
- privacy

When a Mitel 600 DECT phone user is involved in a SRTP call, a key icon in the call display indicates that the media path to the next hop is ciphered.

The key icon is only displayed when the connection uses SIP over TLS, SRTP (for 3G RFPs only) and DECT encryption together for a secure key exchange and a secure media transport.

## 3.6 MIXED DECT BASE STATION INSTALLATIONS

In sites (or whole systems) with Hi-Q audio disabled, any combination of RFP 32/34 IP / RFP 42 WLAN and RFP 35/36/37 IP / RFP 43 WLAN is allowed. Note, however, that some security features are not supported for all DECT base stations (i.e., SRTP is supported on 3G RFPs only, enhanced security is available with RFPs 35/36/37/43).

### RFP SL35 IP support

SIP-DECT supports the RFP SL35 IP after applying the unlock file and the standard SIP-DECT software to the DECT base station.

Before the standard SIP-DECT software can be installed on the RFP SL35 IP, the unlock.xml file must be available for the DECT base station on the USB. After applying the unlock.xml file the DECT base station accepts the standard SIP-DECT software.

In terms of licensing, the OMM manages the RFP SL35 IP with the unlock file and the standard SIP-DECT software like an RFP 35 IP.

For a detailed description see section 7.30.

## 3.7 WIRELESS LAN (WLAN)

If you have a number of WLAN DECT base stations (RFP 42 WLAN or RFP 43 WLAN), the SIP-DECT system also provides access to your company LAN via Wireless LAN. The RFP 43 WLAN also supports 802.11n. The WLAN configuration of a group of WLAN RFPs is managed by WLAN profiles (see section 5.8).

### 3.7.1 802.11I: WPA2-ENTERPRISE PRE-AUTHENTICATION FOR FAST ROAMING

WLAN stations (e.g. laptop) which decide to roam to another WLAN access point (AP) must perform the full authentication process with the new AP. In 802.1X (RADIUS) networks this can take a long time resulting in network dropouts during the roam.

The AP share authentication information with other APs, so the station can authenticate faster (pre-auth) when roaming to a new AP. This method reduces network dropouts significantly.

The RFP43 automatically enables pre-authentication for WPA-Enterprise enabled WLANs. The RFP 42 does not support this feature.

### 3.7.2 CHANNEL CONFIGURATION FEEDBACK FOR HT40 AND TX POWER

The HT40 channel configuration in 802.11n enabled networks may not always become active because of other access points that use channels that would overlap. In this case, the RFP43 falls back to HT20.

From SIP-DECT 5.0 on, the effective channel configuration and the transmit power are reported to the OpenMobility Manager.

You can view these parameters in the OMM Web service and the OMP (**DECT base stations > Device list -> Show details – WLAN** tab) and change the channel to a frequency without overlapping APs.

## 3.8 DECT BASE STATION SYNCHRONIZATION

To ensure a seamless communication experience, the SIP-DECT system switches an ongoing DECT phone call from one DECT base station to another if the radio communication quality drops below a certain threshold. The seamless handover is possible only if the participating DECT base stations are synchronized. DECT base station synchronization is performed via radio communication between DECT base stations, which in turn requires a decent radio coverage planning (see section 7.2).

### 3.8.1 CLUSTERING AND PAGING AREAS

Your SIP-DECT system may include different locations, where the distances between the locations prevent the RFPs from performing the over-the-air synchronization. In this case, you must split your network into clusters (or “synchronization domains”). You assign DECT base stations to cluster numbers for this purpose (see section 5.6.3 “DECT settings” or section 6.7.1.2, “DECT tab”). Note that overlap between different clusters on one campus or site must be avoided.

If your SIP-DECT system consists of a very large number of DECT base stations, you should configure the paging area size to optimize the signaling necessary for paging a DECT phone in throughout the SIP-DECT system (see 6.7.2).

A separate cluster number is also required for a remote site (e.g., for a single DECT base station servicing an office abroad). Also, if the VPN network connection to the isolated site’s DECT base station cannot transport DHCP, you may use static IP address configuration for the single DECT base station (see section 7.6).

## 3.9 DECT BASE STATION RESET TO FACTORY SETTINGS

A DECT base station can be reset to factory settings using a USB flash drive with a file on it named “factoryReset”. When the USB flash drive is plugged into the DECT base station, the DECT base station is reset to factory settings automatically. The file is automatically removed from the USB flash drive during this process.

You can also reset the base station to default settings using the OM Configurator or the OMM Web service (see section 7.7.8).

## 3.10 SYSTEM REDUNDANCY

The SIP-DECT solution offers a number of features to support system robustness and redundancy.

### 3.10.1 OMM STANDBY

The OMM is the central management entity in a SIP-DECT system and therefore constitutes a single point of failure. It is possible to automatically transfer the OMM function to a second DECT base station in case of failure or loss of network connection (see section 7.15).

In an OMM standby implementation, it could happen in rare cases that both OMMs become temporarily active. In such a situation, all SIP-DECT users are SIP registered from to the configured PBX both OMMs. This can cause problems if the PBX accepts only one registration per user (non-forking proxy).

To prevent this scenario, SIP-DECT has a mechanism to detect situations with two active OMMs. When such a situation is detected, the remaining active OMM will SIP re-register all users to the PBX.

This mechanism can be enabled/disabled through the “SIP reRegister after 2 active OMM failover” parameter in the OMP **System** -> **SIP**-> **Supplementary Services** menu (see section 5.4.3.6)

### 3.10.2 BACKUP SIP PROXY/REGISTRAR

To increase the operational availability of the system in critical environments like hospitals, the OMM offers a new failover mechanism for the SIP server. Therefore, in addition to the primary proxy, outbound proxy and registrar server, it is possible to configure two additional levels of backup servers named “secondary” and “tertiary” servers (see section 7.20.3).

In addition, a keep-alive mechanism implemented in the OMM allows the automatic failover to secondary/tertiary servers or automatic coming back to primary servers (see section 7.20.4).

### 3.10.3 CONFIGURABLE USER ACCOUNT FOR STANDBY CHECK

The “Standby OMM” feature of SIP-DECT allows configuration of the user account to be used to check the availability of the iPBX. An availability check starts automatically in fail over situations.

The OMM starts a SIP registration for a specific DECT phone user and sends an OPTIONS request to the configured SIP proxy. If there is an answer, the SIP proxy/registrar is considered reachable and the standby OMM becomes active.

With previous SIP-DECT releases, the OMM used the user account with the lowest phone number for the check procedure. To select a specific user account for this purpose, enable the “Used for visibility checks” flag in the user settings (see section 6.10.4).

**Please note:** The “Used for visibility checks” flag can only be set for one user. The number for visibility checks is shown under OMP **Status** -> **Users** -> **Number** menu. If the flag is not set for a specific user, the OMM uses the user account with the lowest phone number.

### 3.10.4 USER DATA SYNCHRONIZATION (MIVOICE 5000 DUAL HOMING SUPPORT)

SIP-DECT 6.1 introduces support for MiVoice 5000 dual homing, to ensure that SIP-DECT telephony services survive if the network connection to the OMM goes down. Dual homing is achieved through user data synchronization across all OMMs in the system. Every peripheral OMM propagates changes in user, device, Configuration over Air (CoA) profiles or SARI configuration to a central OMM. Every OMM

in the installation (including the central OMM) can use a standby OMM. AXI is used to distribute configuration changes between the central and peripheral OMMs.

For more information on this feature, see section 7.16.

## 3.11 SIMPLIFIED LICENSING

With SIP-DECT 6.0 or later, the licensing model is simplified. The system no longer distinguishes between different DECT base station “soft-brands”, and some licenses are deprecated. See section 3.32 for more information.

**Please note:** New license files are not compatible with SIP-DECT 4.0 (or older) systems.

## 3.12 EXTENDED REGULATORY DOMAIN SUPPORT

SIP-DECT 6.1 enables operation of the SIP-DECT solution in more countries. The SIP-DECT system can be operated in all countries that allow operation of DECT devices with frequency bands and transmit power settings supported by the current SIP DECT phones and base stations. In most cases, this requires different frequency channel and transmit power settings.

This feature is intended mainly for installations on cruise liners, where the SIP-DECT system requires a switch of regulatory domain depending on the actual location of the ship. Such systems are planned and installed based on a site survey with 100mW transmit power. The lower transmit power value is used at all times, independent from the regulatory domain.

A new regulatory domain, 1910-1927MHz\_250mW, has been added for South America. You can configure this regulatory domain via the OMP (**System** -> **Basic settings** -> **DECT** tab); see section 6.5.1.2 for configuration details.

In addition, a new parameter is introduced to limit the DECT base station transmit power to 100mW, independent of the active regulatory domain. The active transmit power is sent to the DECT phone when it registers its location with the OMM. The DECT phone adjusts its transmit power to the value received from the OMM.

## 3.13 DECT PHONE FUNCTIONALITY

### 3.13.1 DECT PHONE DOWNLOAD OVER AIR

The Mitel 600 series DECT Phones can download and upgrade their firmware via DECT over the air.

As of SIP-DECT 6.0, the DECT base station software image (iprpf3G.dnld) contains the Mitel 600 DECT phone software. If the DECT base station houses the OMM, the OMM uses this software to update the DECT phones. The DECT base station OMM no longer automatically attempts to load a DECT phone software image from a DECT base station software URL when provided via DHCP or local configuration.

For specific maintenance purposes only, SIP-DECT allows configuration of a URL via the OMM Web service or OMP to use an alternative DECT phone software image (see section 5.4.1.6). The Mitel 600 DECT phone firmware packages are delivered in the “600.dnld” file for the OMM running on a DECT base station.

For large installations using a Linux Server-hosted OMM, a DECT base station software image (iprfp3G.dnld) without Mitel 600 DECT phone software is available to reduce network traffic in update scenarios.

The DECT phone firmware packages are included in the OMM installation package for Red Hat Enterprise Linux (RHEL) and CentOS for the Linux server version of the OMM.

**Please note:** An DECT base station upgrade from SIP-DECT 3.0 to 6.0 or later is not supported due to the extended DECT base station software image. The 3.0 software does not accept the extended software image.

For large installations using a Linux Server OMM, the DECT base station software image (iprfp3G.dnld) without Mitel 600 DECT phone software can be used. This software image supports a direct RFP upgrade from SIP-DECT 3.0 to 6.1.

### 3.13.2 CENTRAL DECT PHONE CONFIGURATION OVER AIR (COA)

SIP-DECT 6.0 and later supports centralized DECT phone configuration over the air (CoA) for Mitel 602 DECT phones. DECT phone CoA is useful for deployment of special configuration to a single DECT phone or a large number of DECT phones. No local access to the DECT phone is required.

DECT phone CoA is implemented by providing additional configuration information to the well-known configuration files or providing profiles via OMP. Configuration can be changed at the device level (DECT subscription) or the user level (based on login).

Configuration of all DECT phones with a predefined default profile is also supported. Up to 20 possible DECT phone profiles make it easy to adapt to different usage scenarios for heterogeneous user groups (e.g., nurses and doctors in hospital environments). See section 7.23 for more information on this feature.

#### 3.13.2.1 CoA enhancements

The Mitel 602 DECT phone 6.1 firmware (bundled with SIP-DECT release 6.1) includes new features which are configurable via Configuration over Air (CoA).

New configuration commands allow you to overwrite local key programming on the Mitel 602 DECT phones. SIP-DECT 6.1 also supports configuration of the new XML application hooks introduced for the XML terminal interface via CoA (see section 3.32).

In addition, the Mitel 602 DECT phone 6.1 firmware introduces variable lists. A variable list includes a number of items, each of which corresponds to an action to be performed on the DECT phone. For more information, see section 7.23.5.

### 3.13.3 OMM DECT PHONE PROVISIONING

While some users in the SIP-DECT system use a dedicated DECT phone, it is also possible to operate shared DECT phones. The SIP-DECT solution provides an enhanced DECT phone sharing and provisioning concept that enables the management of a large number of DECT phones and provides a flexible subscription model.

The SIP-DECT system allows logging into and out of different DECT phones with a personalized user account, import of user data from an external provisioning server, automatic subscription of new DECT phones, and control of subscription-specific system functions from DECT phones.

See the *SIP-DECT DECT Phone Sharing and Provisioning Guide* for details on this feature.

### 3.13.4 MITEL 600 DECT PHONE DIAL EDITOR MODE

It is assumed that most customers use digits only in their dialing plan, and that it is more convenient if dial editors support only the digits 0 to 9, \* and #. The **Dial editor supports digits only** flag (on the OMP (**System** -> **Advanced settings** -> **DECT Phones** tab) enables this mode. In this mode, the \* has the meaning of a digit to be merely dialed, even if it short-pressed.

If the mode is not set to digits only, the short pressed \* will change the editor mode to alphanumeric.

### 3.13.5 MITEL 602 DECT PHONE CUSTOMIZABLE BOOT TEXTS

By default, the text shown on the Mitel 600 DECT phone at start up is Mitel-specific (branded in the firmware). Customers can also define their own text (on the OMP (**System** -> **Advanced settings** -> **DECT Phones** tab).

## 3.14 HOT DESKING

SIP-DECT 6.2 introduces support for hot desking functionality, as provided by the MiVoice Business platform.

Users with hot desking permissions are configured in the OMM system without a bound device, and the hot desking capability flag set to enabled.

The hot desking capability allows a user to use the same extension on multiple devices. For example, a user who has a hot desk extension can log into the DECT phone and be automatically logged out of the desk phone (and vice versa).

The user can initiate a log out from the DECT phone via the **Administration** menu on the device.

## 3.15 CONFERENCING

To improve the integration with different SIP servers, SIP-DECT includes support for centralized and internal three-way conferencing.

The centralized conferencing feature is based on RFC 4579 and supports the use of external third party conference servers (e.g. Broadsoft or Sylanro servers), which are RFC 4579-compliant.

SIP-DECT also includes an integrated conference server implementation based on RFC 4579. The integrated conference server offers SIP-DECT users who are hosted on SIP servers without their own conference solution, the opportunity for three-way conferencing.

The centralized as well as the integrated conferencing feature allows users to:

- merge two active calls together into a conference call
- transfer another party into the conference when on an active conference call
- disconnect from an active conference call while allowing the other participants to remain connected

Regardless whether the centralized or the integrated conferencing is used, conferences can be initiated from the Mitel 600 and Mitel 142d DECT phones.



For a detailed description of conferencing functionality, see section 0.

### 3.15.1 CONFERENCING AUDIO NOTIFICATION

The SIP-DECT Integrated Conference Server (ICS) notifies all conference participants when someone is joining or leaving the conference. The notification is a specific tone for joining and a specific tone for leaving the conference.

### 3.15.2 CENTRALIZED CONFERENCING WITH MIVOICE BUSINESS

SIP-DECT 6.1 introduces support for centralized conferences hosted by the MiVoice Business platform. The SIP signaling implemented by the MiVoice Business platform requires that the SIP-DECT implementation initiate a conference via blind transfer. The conference mode (External – blind transfer) can be configured globally for all SIP-DECT users (via the OMP **System** -> **SIP** -> **Conference** tab) or configured individually for SIP-DECT users (via the OMP **DECT Phones** -> **Users** -> **Conference** tab). SIP-DECT 6.1 also introduces a new Feature Access Code. The new “Blind transfer” Feature Access Code allows a user to initiate a SIP blind transfer from the Mitel 600 DECT phone. You can configure the FAC via the OMM web service (see section 5.9.4) or the OMP (see section 0).

**Please note:** Overlap sending is not supported for FAC. The blind transfer FAC and the following transfer target number must be entered en-bloc. The blind transfer FAC cannot be triggered manually from the dial editor.

To support the integration of SIP-DECT with the MiVoice Business platform, SIP-DECT 6.1 extends the XML terminal interface for the Mitel 600 DECT phone to include new predefined XML application hooks. These additional functions can be applied to the DECT phone's programmable keys or accessed from a menu.

You must configure the appropriate hooks in the OM via the OMM Web service or OMP (**System Features** -> **XML Applications**) to make the applications available on the Mitel 600 DECT phones.

## 3.16 SIP OVER UDP/TCP/TLS

In addition to UDP, SIP-DECT also supports TCP and TLS as transport protocols for SIP signaling. The OMM provides the following transport protocol modes:

- **UDP:** all SIP messages are sent/received via UDP
- **TCP:** all SIP messages are sent/received via TCP
- **UDP/TCP:** all outgoing connections are always set up via TCP, but incoming SIP messages are also accepted when sent over UDP
- **TLS:** all SIP messages are sent/received via TLS connections
- **Persistent TLS:** all SIP messages are sent/received over TLS connections. The OMM tries to keep the connection to the SIP server open permanently.

### 3.17 SIP MULTIPOINT

Some call server platforms (e.g. Cisco CUCM) and internet telephony provider environments (SBCs) do not accept SIP registration from different users who have the same IP address and port, but require a unique source signaling port for every SIP extension. By default, the OMM uses one source port for all extensions, but does allow the configuration of individual local signaling ports for users and conference rooms.

The port range is set per protocol (i.e., UDP/TCP and TLS), and must not overlap with other ports in use.

The following parameters can be configured or read per user (see section 6.10.4) and conference room:

- **Fixed port:** Port used explicitly for SIP signaling. If set to 0, an automatically calculated port is used for this user or conference room. The default is 0.
- **Calculated port:** a read-only parameter whose calculation is based on the internal user or conference room ID and a configurable port range, in a way that all users or conference rooms are spread over the range.

The calculation is based on the following rules:

$$\begin{aligned} \text{UserPortCount} &= \text{UserPortRangeStart} - \text{UserPortRangeEnd} + 1 \\ \text{UserPort} &= ((\text{UserID} - 1) \% \text{UserPortCount}) + \text{UserPortRangeStart} \end{aligned}$$

$$\begin{aligned} \text{ConfRoomPortCount} &= \text{ConfRoomPortRangeStart} - \text{ConfRoomPortRangeEnd} + 1 \\ \text{ConfRoomPort} &= (\text{ConfRoomID} \% \text{ConfRoomPortCount}) + \text{ConfRoomPortRangeStart} \end{aligned}$$

The “Calculated port” is first updated with the SIP registration of the user or conference room.

Depending on the “Register Traffic Shaping” settings and the number of users/conference rooms, the update may take some time.

The port ranges used for the port calculation can be configured globally for all SIP DECT users and conference rooms via the OMP (see section 6.5.4.1).

**Please note:** To provide each user and/or conference room with a unique port using the port calculation, the port range must be greater than or equal to the number of users or conference rooms.

#### Configuration Rules for Port Ranges

Please note the following configuration rules for configuration of the UDP/TCP and TLS port ranges:

- Port ranges for users and conference rooms may not overlap.
- A port range configured outside the defaults (5060, 5061, 4060, 4061) can be within the range 17000 – 32767.
- Port ranges may not overlap with the ports of other OMM services. See section 10.4 for a list of all ports and protocols.
- If the OMM is running on a DECT base station, the ranges may not include ports used by other DECT base station protocols. See section 10.4 for a list of all ports and protocols.
- The port range for conference rooms is limited to 100 ports.
- The port range for users is limited to the following:  
RFP OMM: maximum 512 ports  
Linux Server OMM: maximum 10,000 ports

## 3.18 UTF-8 ENCODING

The UTF-8 support allows the display of a wider range of language specific characters (e.g., umlauts) and facilitates localization for different markets. The OMM and the Mitel 600 DECT phone family support UTF-8 for text messaging.

In addition, the OMM and the Mitel 600 DECT phones support an extended character set for

- User parameters (configurable via WEB, OMP or external user configuration files)
  - System name
  - User name
  - Number
- SIP “display names” und SIP “user id’s” of incoming and outgoing calls
- Call logs
- LDAP directory access
- XML terminal interface objects

For third-party GAP DECT phones, Mitel DECT 142 / Mitel 142d or Mitel 600 with older firmware releases, the UTF-8 character set is not supported. If possible, the OMM maps UTF-8 character to LATIN-1.

**Please note:** The available set of characters is defined by the DECT phone. Please see /31/. User configuration files must be encoded in UTF-8.

## 3.19 ALPHANUMERIC DIALING

SIP-DECT supports the dialing of alphanumeric characters. This allows a user to dial names (e.g. “Heinrich.Mueller”) as well as digits.

If SIP URI dialing such as “name@domain” is used, you must use an (outbound) proxy that supports the interpretation of SIP user names, including domain names.

**Please note:** The “Digit treatment” feature handles dialed digit strings only. It cannot be applied with UTF-8/alphanumeric dialing.

## 3.20 VOICE MAIL NUMBER

You can configure a system-wide voice mail number. This number is used by the Mitel 600 DECT phone family if a voice box call is initiated. The system-wide voice mail number can be overruled by a user-specific voice mail number. If there is no voice mail number configured or another type of DECT phone is used, the voice mail number must be configured locally on the DECT phone.

**Please note:** The voice mail number is supported by the external user data configuration files. The parameter UD\_VoiceMailNumber can be set in the user\_common.cfg and/or “user.cfg” or “LoginID.cfg” e.g. “UD\_VoiceMailNumber=222”. For details, see the *SIP-DECT DECT Phone Sharing and Provisioning Guide*.

## 3.21 CALL HANDLING

SIP-DECT supports a number of features for enhanced call handling.

### 3.21.1 DIVERSION INDICATION

The OMM supports the displaying of diversion indications for Mitel 142d and Mitel 600 DECT phones based on the SIP Diversion Header defined in RFC 5806. This feature is only available with IPBXs generating such Diversion Headers.

When an outgoing call from a Mitel 142d / Mitel 600 phone is being diverted to another destination (i.e. via call forward), the phone displays the Caller ID (phone number and/or caller name) of the new destination and the reason for the call diversion (if delivered from IPBX). Similarly, at the new destination, the Caller ID of the original call destination is displayed.

#### Example:

- 1 Tim calls Mark at 5142.
- 2 Mark's phone is busy and diverts the incoming call to Roger at 5141.
- 3 Tim's phone displays the extensions where the call is being diverted to and the reason for diverting the call.
- 4 Roger's phone starts ringing and displays the name and number of the phone the incoming call (Tim) and the original called destination (5142).

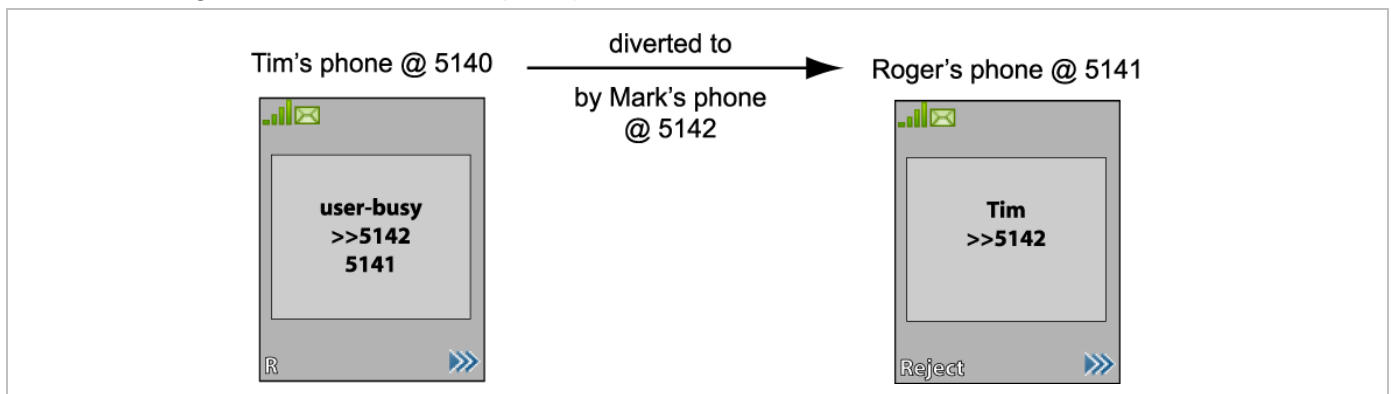

### 3.21.2 CALL COMPLETED ELSEWHERE

SIP-DECT supports the SIP "Reason" header field defined in RFC 3326.

When SIP-DECT receives a CANCEL request including a "Reason" header field with "cause=200", the incoming call will be marked as accepted in the local incoming call logs of the Mitel 600 and Mitel 142d phones.

### 3.21.3 SEMI-ATTENDED TRANSFER

The SIP message sequence for a "Semi-Attended Transfer" allows the transferor to start the transfer while the target phone is still ringing.

SIP-DECT supports different behaviors for semi-attended transfers. This can be configured on the OMP SIP -> **Advanced settings** tab (see section 6.5.4.2).

The supported modes are:

Semi-attended transfer mode	Refer-to with replaces	Behavior
Blind	No	The semi-attended transfer is handled as a blind transfer. The phone sends CANCEL before REFER for semi-attended transfer.
Blind	Yes	The semi-attended transfer is handled as a blind transfer. The phone sends REFER with Replaces for semi-attended transfer and no CANCEL. This behavior is not SIP compliant but necessary for some iPBX platforms.
Attended	-	The semi-attended transfer is handled as an attended transfer. Both lines of the transferor remain active until the transfer succeeds. This behavior is compliant to RFC 5589.

**Please note:** The mode “Semi-attended transfer mode: Blind” with “Refer-to with replaces: yes” is not SIP compliant and should only be used on iPBX platforms that require that signaling.

### 3.21.4 THIRD LINE HANDLING FOR MITEL 142D AND 600 DECT PHONES

In earlier implementations of SIP-DECT user call control, a waiting call forces the user to react to that call (accept or reject), before he can use other supplementary services like call transfer, conference or inquiry call options.

In the new implementation, a third line is reserved for call waiting purposes. The waiting call is kept in the background, even if the receiving user decides to finish supplementary services first (see rule at the end of this subsection). It is also kept, if two lines are already used for brokering (in the former implementation, the incoming call was answered with busy state). After one of those lines is released, the waiting call can be accessed by the known means (by R-key or the referring menu options).

**Please note:** The Third Line Handling is available for Mitel 142d and Mitel 600 DECT phones, but not for third party GAP phones.

Third Line Handling follows the existing MMI philosophy of the DECT phones. If the user wants to continue supplementary services when a call comes in:

- R-Key will accept the incoming call. All supplementary services will involve that incoming call directly or indirectly.
- Selecting “Transfer” or “Brokering” offers the possibility to keep the waiting call and continue supplementary services with the former line only. The waiting call is not involved but can be accepted later.

**Please note:** The Third Line Handling feature offers the option to receive a further incoming call only. A user cannot open a third line as the active part (e.g. to open a further third line for an inquiry call in a brokering situation, where two lines are already involved).

### 3.21.5 CALL TRANSFER ENHANCEMENTS FOR MITEL 142D DECT PHONES

The blind transfer has been slightly simplified. The second confirmation after selection of the transfer targets number by the “start” button is removed. So the steps are reduced to:

- Press I-Key within a basic call
- Select “Transfer”
- Select editor or phonebooks
- Edit or select destination and press “OK”

In earlier OMM releases (SIP-DECT 4.0 and earlier), call transfer had to be initiated via menu. Pressing the hook key led to the release of the active line and a callback menu popped up.

The OMM now allows the use of the hook key for call transfer, as it is already known from Mitel 600 DECT phones. To enable this feature, the administrator must enable the “Call Transfer by Hook” feature in the OMP **System -> SIP -> Supplementary Services** menu.

To initiate a transfer via the hook key, do the following:

- initiate an inquiry call and dial
- wait for completed connection (optional)
- press the hook key

You can still initiate a transfer via the menu, as before.

If the “transfer by hook” capability is set, the release of the active line in brokering state must be done via the menu option “Release”:

- Press I-Key within an inquiry call or brokering state
- Select “Release”

## 3.22 TRUNCATING SIP USER NAME IN SIP URI

If user name info in SIP to-/from-/contact headers or p-asserted-identity is extended by a suffix, which is separated by a semicolon, this suffix is truncated before the username is printed to call displays or DECT phone internal call logs.

Example: If the DECT phone receives

Contact: "Dominique B." sip:5405;openSipsTestproxy@testlab.mitel.randd.com

only 5405 will be extracted as user name to be printed. The display name “Dominique B.” will also be shown, but the extension “openSipsTestproxy” will be removed.

To enable this feature, the administrator must set the “Truncate Caller Identification” parameter in the OMP **System -> SIP -> Supplementary Services** menu.

## 3.23 OM LOCATING APPLICATION

You can set up a system to locate and track DECT phones in your DECT system. This includes a separate Web user interface, which for example can be operated by service personnel to locate a DECT phone that has triggered an alarm. Refer to the *OpenMobility Locating Application User Guide* for details (see /27/).

The OM Locating application can display small maps showing the placement of a DECT base station. In earlier SIP-DECT releases, these graphic maps had to be generated manually by using a graphic editing program.

The OM Management Portal (OMP) can be used to generate the graphic map images needed by the OM Locating application.

Images showing the floor plan of the buildings belonging to the OM system can be imported into the OMP. In a next step the RFPs of the SIP-DECT system can be placed on these images with drag and drop. Finally for each of the RFPs, the graphic map images will be generated in the format and size as required by the OM Locating application.

The process and the OMP functionality for this feature are described in detail in section 7.23.

## **3.24 EXTENDED MESSAGING**

You can set up an extended messaging and alarms system (e.g. to provide automated reactions on alarms triggered by DECT phones or on alert messages). The extended messaging system may also provide message-based services, and may also be integrated with external computer systems. See the *OpenMobility Integrated Messaging & Alerting User Guide* for details.

## **3.25 VIDEO SUPPORT**

The SIP-DECT solution supports snapshot images and video streaming via USB video devices connected to DECT base stations.

### **3.25.1 USB VIDEO DEVICES**

You can configure and use USB video devices that are fully supported by the UVC video class device driver. The USB video device is connected to the USB port of a SIP-DECT RFP 35. In conjunction with the “Surveillance” feature of the OM Locating application, the USB video devices generate snapshot images and video streams.

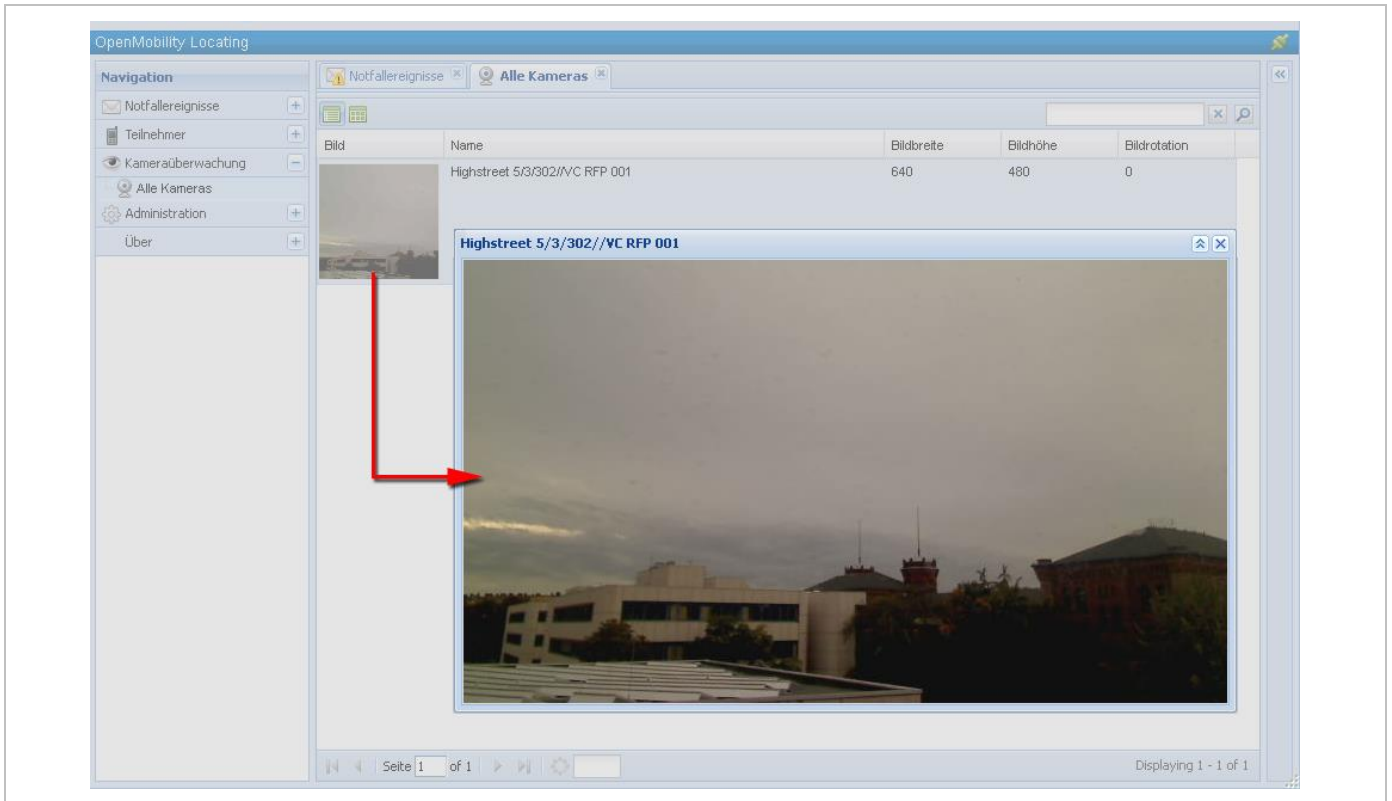

For a detailed description see section 7.27.

One USB camera (only the types Logitech HD Webcam C615 or Logitech HD Pro Webcam C920) can directly be connected to a SIP-DECT RFP 35/43. Such cameras are used as well with the OM Locating Application as with the Terminal Video feature.

### 3.25.2 TERMINAL VIDEO

With SIP-DECT 5.0 and later, the Mitel 602 DECT phones support video streams from cameras connected to SIP-DECT base stations RFP 35/43. When a user has the video stream permission, he can choose in the system menu from a list of cameras to connect.

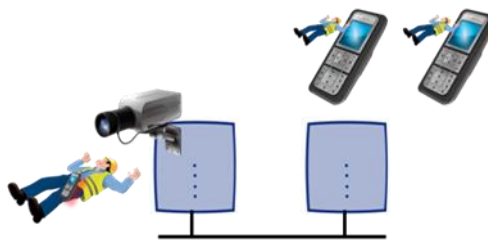

Video Streaming is only available when the DECT phone is connected to a RFP 35/36/37/43 and the permission is set for the site and the DECT phone.

Video streams are treated like a call by the DECT phone, and require two (of eight) air channels on the RFP for each stream. The DECT phone can also perform handover between DECT base stations with an active video connection.

A video connection is automatically terminated by the system in case that any related capability (e.g. video stream permission) is changed.

The maximum number of simultaneous terminal video streams per camera is restricted to 10.



Connection and configuration of cameras is similar to the steps for the locating application. Special steps necessary for terminal video are:

- Enable all sites that have the technical capability (only RFP 35/36/37/43) via OMP for terminal video.
- Enable the additional service “Video stream permission” via OMP (**DECT Phones -> Users**) for those users who are allowed to use this feature.

**Please note:** It is strongly recommended to set the radio fixed parts attributes building, floor and room, if you configure a huge system with a large number of cameras. This will ease the selection of cameras on the DECT phone menu.

A video camera must be configured in OMP before it can be offered to applications and the Mitel 602 DECT phones.

The selection of the menu “Cameras” is offered in the Mitel 602 DECT phone “System menu” (e.g. long press on Menu >>>), if

- at least one camera is plugged and activated by the enable flag
- the DECT phone user has the permission to select cameras
- the DECT phone is located within a site, which allows terminal video

Navigation within the camera menu will be done by OK (and ESC) keys. To establish a video stream, press “hook off” if the name of your camera is selected.

If the number of cameras exceeds the visible lines of the DECT phones display, the presentation is arranged hierarchically. In this case, at least one sublevel must be selected before camera names are offered. The hierarchy of the referenced DECT base station (site, building, etc) is inherited for that purpose.

The destination of a video call is added to the DECT phone internal redial list.

**Please note:** Audio calls or any system service activities are not possible during an established video link. Any kind of auto callback (initiated by a message or pushed by XML notification to direct dial) is not supported for video calls.

## 3.26 USER MONITORING

The OMM monitors the status of the user’s DECT phone to verify the user’s availability to receive calls or messages. By default, passive and active user monitoring is disabled.

In addition to the standard request, response and notification messages, the OMM generates alarm triggers if a user becomes unavailable. The alarm triggers can be consumed by the OM IMA, the OM Locating application, or another application using OM AXI. If a user becomes available again, the OMM sends an additional alarm trigger to indicate the change in status.

User status information is available via OM AXI and OMP.

For a detailed description of the “User monitoring” feature see section 7.29.

## 3.27 CORPORATE DIRECTORY INTEGRATION

The SIP-DECT solution supports integration of up to five directory servers. The configured directories are displayed in a list on the Mitel 600 DECT phone when the user invokes the central directory function, and search by name to retrieve phone or mobile numbers (as well as email addresses for SIP-DECT messaging applications). Note that users can only access one directory at a time.

SIP-DECT supports LDAP and XML directories, and as of SIP-DECT 6.2, Broadsoft XSI-based directories are also supported. XML-based directory services can be implemented using the XML terminal interface.

The SIP user name and SIP authentication credentials can be used for directory access, or can be specified separately. If different from the SIP user name and authentication credentials, the user name and credentials must be explicitly configured for each user.

For configuration information see section 6.12.5.

## 3.28 INTEGRATION INTO EXTERNAL MANAGEMENT SYSTEMS

You can use the following features to integrate the SIP-DECT system into external management systems:

- Each DECT base station may run an SNMP agent that can be queried by SNMP management software (see 7.19).
- To further integrate into external configuration management systems, the DECT system's configuration is available by means of ASCII-based configuration files. You can configure automatic import of configuration files from an external server. For more information, see section 7.8.
- The OM AXI software application interface can also be used for integration into external systems. Refer to the OM Application XML Interface (OM AXI) specification, see /31/.

## 3.29 SYSTEM CONFIGURATION TOOLS

You can configure and maintain the SIP-DECT system with two different applications:

- the Web-based OMM Web service (see section 5)
- the Java-based OM Management Portal (OMP, see section 6)

Both applications support the essential configuration and administration settings required for smaller SIP-DECT systems. However, for larger SIP-DECT systems using enhanced features, some settings are only available in the OMP application.

The following table lists the features and settings that are available in each configuration tool:

Feature	Web	OMP
SNMP configuration	Yes	Yes
DB management: User data import	No	Yes
Configuration and start of a system dump	Yes	Yes
Download system dump to PC	No	Yes
Event information display (Event log)	Yes	Yes

WLAN profile configuration	Yes	Yes
Dynamic DECT phone subscriptions (OpenMobility provisioning)	No	Yes
Locating settings for DECT phone	No	Yes
Paging areas	No	Yes
Alarm Triggers	No	Yes
DECT base station sync. View	No	Yes
DECT base station statistics	No	Yes
DECT base station data export	No	Yes
Capturing unconfigured DECT base stations	Yes	Yes
Configuration of XML applications (SIP-DECT XML terminal interface)	Yes	Yes
Configuration of SIP backup servers	No	Yes
User monitoring	No	Yes

## 3.30 SIP ENHANCEMENTS

With SIP-DECT 6.0 and later, the SIP-DECT solution provides several enhancements to the SIP protocol implementation.

### 3.30.1 GLOBALLY ROUTABLE USER-AGENT URIS (GRUUS)

Globally Routable User-Agent URIs (GRUUs) provide a way for anyone on the Internet to route a call to a specific instance of a SIP User-Agent. IP-DECT provides GRUU support according to RFC 5627.

A “sip.instance” is added to all non-GRUU contacts. You can enable or disable this support via OMP or Web service (**System -> SIP -> Basic Settings**).

### 3.30.2 SESSION TIMER

SIP-DECT supports RFC4028 “Session Timers in the Session Initiation Protocol (SIP)” to keep call sessions alive and to determine whether established call sessions are still alive.

You can configure the session refresh period via OMP or Web service (**System -> SIP -> Advanced Settings**).

### 3.30.3 SIP CONTACT MATCHING

In special Network Address Translation (NAT) environments, the Contact URI in a SIP response to a REGISTER request may not match the URI originally sent out.

In such cases, SIP-DECT offers the “SIP contact matching” configuration parameter. You can enable this parameter via OMP or Web service (**System -> SIP -> Advanced Settings**).

### 3.30.4 CONFIGURABLE CALL REJECT STATE CODES

The SIP status codes for user-rejected calls and device-unreachable calls are configurable via OMP and Web service (**System -> SIP -> Advanced Settings**).

### 3.30.5 CALL RELEASE TIMERS

SIP-DECT 6.0 or later allows changing certain system default timers. These timers determine the DECT phone call behavior when calls are released by the B party.

You can configure the "Call release timeout", "Hold call release timeout", and "Failed call release timeout" parameters via OMP or Web service (**System -> SIP -> Supplementary Services**).

### 3.30.6 INCOMING CALL TIMEOUT

Incoming calls are automatically rejected when the user does not answer the call within 180 seconds. This time period is too short for special customer use cases.

You can configure this interval through the "Incoming call timeout" parameter via OMP or Web service (**System -> SIP -> Advanced Settings**).

## 3.31 AUTO ANSWER, INTERCOM CALLS AND AUDIO SETTINGS

Certain call features force the DECT phone to call a specified SIP user automatically and, as an option, to establish a speech path immediately without any intervention by the DECT phone user.

SIP-DECT allows control of the following audio settings on the DECT phone to prevent unauthorized parties from hearing the call:

- Speech path can be initially set to be muted
- A warning tone may be generated

SIP-DECT also supports intercom calls. This means that the originating party can force the called party's phone to establish a speech path immediately. Control of the same audio settings applies.

### 3.31.1 INTERCOM CALLS

A DECT phone can be forced to answer an incoming SIP call automatically if certain information is included in the SIP header. A DECT phone user can also initiate an intercom call, which automatically triggers the destination to talk.

Intercom calls can interrupt active calls ("barge in"). If it is an established basic call, the active call is put on hold. In more complex call situations, a "barge in" always supercedes existing active calls, unless the active call is a "SOS" call.

The call is identified as an intercom call if the SIP INVITE header includes:

- a "Call-Info" header containing "answer-after=0"
- an "Alert-Info" header containing "info=alert-autoanswer"

**Please note:** This feature is only available for Mitel 600 DECT Phones, version 4.0 or higher.

#### 3.31.1.1 Barge-in of incoming intercom call

If a "barge in" action on an existing call is necessary, note the following rules about the treatment of existing active calls:

- If the user is in a basic call (one line already active) or is brokering (two lines are used), the active line is placed on hold and kept in the background. No line is released.

- Incoming ringing calls which are not yet connected are converted to waiting calls.
- If a third line is open due to a waiting call, that call is released and the line is replaced by the intercom call.
- Outgoing calls that have not yet been answered and are in a dialing state, are released.
- If a call is on hold by the B party, the call is released. An on-hold by the B party is difficult to maintain while another line has an active audio stream.

Normally, the user should be able to resume the interrupted calls again when the intercom call is finished. However, the calls may fail if several maintained lines collide with call exceptions (e.g., a failed call transfer that was maintained in the background).

**Please note:** Barge-in is rejected if the DECT phone is part of a SOS/alarm call.

### 3.31.1.2 Outgoing intercom calls

A DECT phone can initiate an intercom call. The user must dial the configured access code, followed by the destination's user id / number.

If a DECT phone generates an intercom call, an Alert-Info header is added to the SIP INVITE:

- the "Alert-Info" header contains "<http://x>info=alert-autoanswer"

### 3.31.2 AUTO ANSWER AUDIO SETTINGS

You can configure global auto-answer settings through the OMM Web service or the OMP. Global settings are valid for all DECT phone users in the system, except users who have individual settings.

Incoming call settings:

- Auto answer allowed (default: true)
- Microphone mute (default: true)
- Warning tone (default: true). A short ringtone is played if there are no active calls. If there is an active call in a "barge in" situation, the ringing will be in-band.
- Allow barge in (default: true)

Outgoing call setting:

- Dial prefix (default: string is empty). Empty string means that an intercom call cannot be initiated by a DECT phone.

#### 3.31.2.1 User-specific incoming call setting

You can set user-specific settings via OMP, but not the OMM Web Service. Default values for all parameters are inherited from global settings.

## 3.32 SIP-DECT XML TERMINAL INTERFACE

The SIP-DECT XML terminal interface allows external applications to provide content for the user on the DECT phones display and much more. The interface is derived from the XML API for Mitel SIP Phones and coexists with the OM AXI features e.g. text messaging.

Partners can get access to the interface specification /37/ by registering for the A2P2 program.

To call a certain URI, there are a number of hooks available for the Mitel 600 DECT phones which can be put on a programmable key or can be called from a menu. You can activate the predefined XML hooks via the OMM Web service (see section 5.9.5) or the OMP (see section 6.12.7).

You can also activate the XML hooks through the Configuration over Air (CoA) feature; see section 7.23 for more information.

**Please note:** From SIP-DECT release 3.1 on, behavior for XML objects has been added or changed (see SIP-DECT XML terminal interface specifications for more details).

### 3.32.1 FEATURE ACCESS CODES TRANSLATION

Many PBXs allow the control of PBX supplementary services by dialing specific numbers called feature access codes (FAC). SIP-DECT supports the “Feature Access Codes Translation” XML application to avoid conflicts between SIP-DECT feature access codes or digit treatment rules and PBX feature access codes. If “Feature Access Codes Translation” is activated, SIP-DECT users can choose “FAC” menu on the Mitel 600 or Mitel 142d DECT phones in any call state and enter the feature code en-bloc. The input is sent to the PBX (Application server) within a URI request.

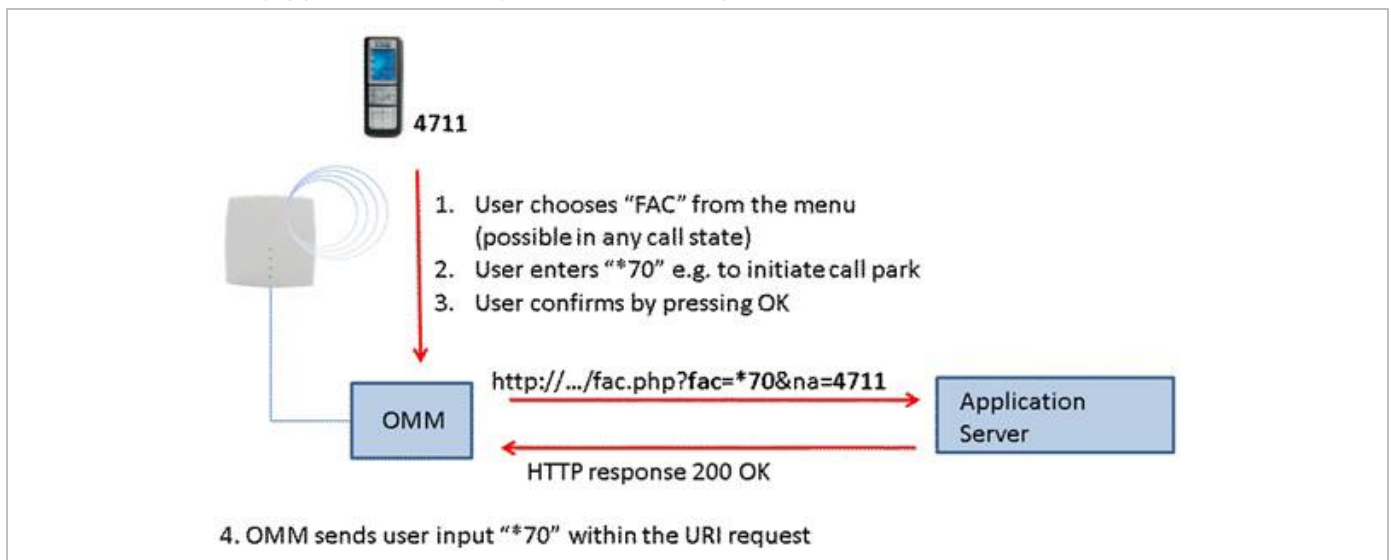

This feature can be configured using OMP on the **XML applications** page (see section 6.12.7).

### 3.32.2 RING TONE SELECTION FOR (ALARM) MESSAGES

This feature extends the capability to set ringer tones to provide an acoustic signal to the receiver of a message and is related to messaging configuration and management function described in the *OM Application XML Interface Specification*.

In previous SIP-DECT releases, the “melody” field offered ten tones, selected by an identifier. In the current release, the “explicitToneSelection” field allows the user to select a tone, which does not have to belong to the set of “melody” tones, by the name string. If both are set, the explicitToneSelection value takes precedence.

**IMPORTANT :** Depending on the DECT phone, not all strings may work. The string value is not checked for correctness. Invalid or unknown string values are ignored.

**Please note:** The OM Message & Alerting License is required to use these features.

# 4 LICENSING

## 4.1 LICENSING MODEL

Licenses are required based on the SIP-DECT system size and feature set. Licensed features include:

- the number of configured DECT base stations
- the Messaging application
- the Locating application

For information on the messaging and locating applications see the appropriate documents listed in the References section (section 10.8).

**Note:** A license to upgrade the SIP-DECT software to a SIP-DECT 6.0 or later is no longer required.

The **License settings** page in the OMM Web Service provides a summary of the SIP-DECT licenses installed.

### 4.1.1 SYSTEM LICENSES

To properly address small, medium and large installations, the SIP-DECT offering is split into the following categories, according to system size.

**Note:** As of SIP-DECT 6.0, no distinction is made between DECT base station brands. License and feature rules apply equally to all DECT base station types (standard RFP, L-RFP). Only the DECT base station hardware determines available functionality.

### **Small systems – 1 .. 5 DECT base stations**

- No license required
- Telephony and basic messaging only
- No locating or enhanced messaging functionality
- PARK code for up to 256 DECT base stations required for operation (provided by the online PARK service)

**Note:** Existing SIP-DECT systems with up to five L-RFPs are automatically migrated to the integrated license model. Larger systems still require a valid license file.

### **Medium systems – up to 256 DECT base stations (minimum 3 DECT base stations)**

- OM System License required for the number of DECT base stations (10, 20, 50, 100, etc)
- Licenses for Messaging and Locating can be added
- PARK code for 256 DECT base stations included in license file

### **Large systems – up to 4,096 DECT base stations**

- OM System License required for the number of DECT base stations
- OpenMobility Manager (core software) resides on one or two Linux-based PCs
- Licenses for Enhanced Messaging and Locating can be added
- PARK code for 4096 DECT base stations included

**Note:** With SIP-DECT Release 6.0 or later, there is no longer a demonstration mode for the OMM.

## **4.1.2 ABOUT G.729 CHANNELS**

With SIP-DECT Release 6.0 or later, the number of G.729 channels is no longer limited to a specific fixed number or license. The number of G.729 channels depends only on the resources available (i.e., DECT base station capacity and number of base stations).

## **4.1.3 PARK SERVICE**

A Portable Access Rights Key (PARK) is required to operate a SIP-DECT system with up to five DECT base stations. (For systems with more than five DECT base stations, the generated license file contains the PARK code). With SIP-DECT 6.0 or later, the PARK code is provided via a centralized Web service; you do not need to enter the code manually (as in earlier SIP-DECT releases). A PARK for up to 256 DECT base stations is available upon request from the OMM Web service.



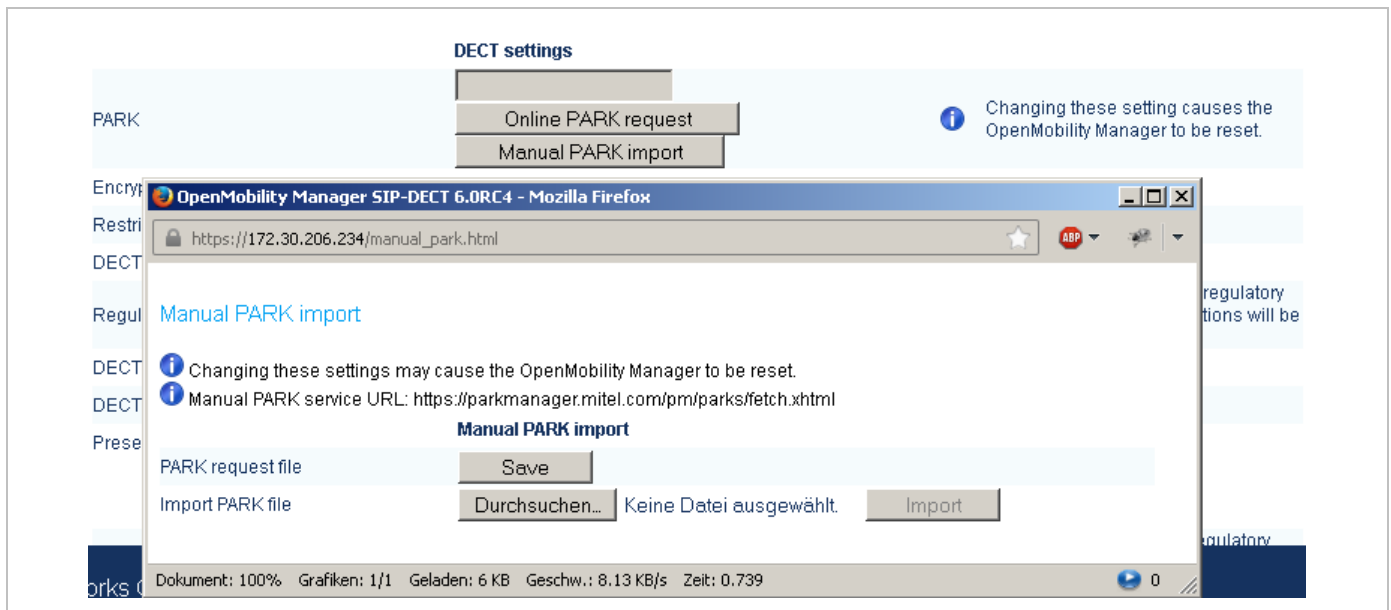

You must have an internet connection to access the online PARK service. If no internet connection is available, you can download a PARK request file from the OMM (PARK service URL is <https://parkmanager.mitel.com/pm/parks/fetch.xhtml>) and upload it to the PARK server from a computer that is connected to the Internet. You can then import the file into the OMM.

If you have a valid license file that includes a PARK, this mechanism is not necessary.

#### 4.1.4 UPGRADE LICENSE

With SIP-DECT Release 6.0 or later, you do not require a license to upgrade to a newer release.

Older systems with an OM Activation License for L-RFPs (3..20 RFP-L) require a license upgrade, which is available from the License server at no cost. Note that you must already have three MAC addresses registered on the license server for the license upgrade.

#### 4.1.5 GRACE PERIOD

The OMM identifies medium and large systems using the unique PARK as well as the MAC addresses of up to three DECT base stations (called validation RFPs here).

Three DECT base stations guarantee redundancy when a hardware or network error occurs. An odd number of DECT base stations prevents system duplication by splitting the system into two separate parts.

When the first validation DECT base station is disconnected, the OMM generates a warning and displays the message on the **Status** page of the OM Web service (see also section 5.3).

If the second validation DECT base station is disconnected, the OMM treats it as a license violation, and starts the timer on a 30-day grace period. When the timer expires, the OMM restricts all licensed features.

When the validation DECT base stations are reconnected to the OMM, the grace period is incremented until it reaches its maximum of 30 days.

## 4.1.6 LICENSE VIOLATIONS AND RESTRICTIONS

A license can be violated in three ways:

- The number of configured items exceeds the number of licensed items. In this case the associated feature is restricted:
  - the audio stream of calls is dropped after 30 seconds when the number of connected DECT base stations exceeds the licensed number
  - the messaging application limits the type of messages to “info”, “low”, “normal” and “high”
  - the locating feature is stopped
- For SIP-DECT 5.0 (or older) systems, the software version in the license file does not match the software version running on the OMM.
- The OMM has no connection to at least two of the validation DECT base stations and the grace period has expired.

The restrictions above are in place until at least two validation DECT base stations are reconnected to the OMM.

## 4.2 UPLOADING A LICENSE FILE

A license file must be generated on the Mitel license server. The license confirmation provided when you order your system contains detailed information on how to generate the license file. The file can be uploaded into the OMM either via Web service (see section 5.10) or via the OMP (see section 6.12.7).

A license file contains a PARK for system identification. If the newly imported PARK differs from the current PARK, the OMM performs a restart. In this case, all existing DECT phone subscriptions will be deleted.

**Note:** The file can be opened with a text editor to view the license or activation parameter.

The license file includes an installation ID. This ID prevents the administrator from loading the wrong license file with a different PARK (resulting in all DECT phones being unsubscribed). The download page for the license file displays the installation ID. If no Installation ID is configured (value 0, which is the default), the ID is automatically set while loading the license file. If the ID does not fit to the license file, the license file import will fail. The installation ID does not change when you load a new license file from the license server, unless the PARK has changed.

The screenshot displays the OMM web interface with the 'License file' tab selected. The 'Server' section contains a 'General' sub-section with an 'Installation ID' field set to '270943175'. Below this are 'OK' and 'Cancel' buttons. The 'License file import' section features a 'File' button, a file selection bar, and an 'Import' button. A warning icon and text state: 'Importing a license file may cause the OpenMobility Manager to be reset.'

The SIP-DECT license file format prepares the system for receiving licenses from Mitel PBXs or to act as a license key server for other Mitel products in future releases.

**Please note:** New license files (as of SIP-DECT 5.0) are not compatible with previous versions of SIP-DECT systems (SIP –DECT 2.1 – 4.0).

## 4.3 LICENSE MODELS

### 4.3.1 SMALL SYSTEM (UNLICENSED)

When changing the PARK on the **System settings** page of the OM Web service, the OMM uses the built-in license resp. the standard license for a small system.

The built-in license for small system features:

- up to five DECT base stations
  - standard telephony
  - sending messages from DECT phones for all users
  - no locating
- Messaging features are generally restricted to type “Info”, “Low”, “Normal” and “High” for all users (no “Emergency” and no “Locating Alert”).

When there are more than five DECT base stations configured, only the first five base stations stay in the configuration database. All other base stations are dropped silently.

### 4.3.2 MEDIUM OR LARGE SYSTEM

When the PARK is set through the upload of a license file, the OMM enters the licensed state. In this state the OMM uses the following license features coded into the license file.

- System license (Medium):
  - three and up to 256 base stations
- System license (Large):
  - three and up to 4096 base stations
  - software version of the OMM allowed to be executed
- Messaging license:
  - whether clients are allowed to receive alarm messages or have enhanced messaging options
- Locating license:
  - number of locatable DECT phones
  - whether the locating application is allowed to execute

When you generate a license file from the license server, you must enter the MAC address of three base stations. These three validation base stations are used to operate the grace period as described in section 4.1.5.

When obtaining the license file from the license server, it is possible to use the PARK used for a small or medium system installation. This prevents the need to re-subscribe all DECT phones.

**Note:** As of SIP-DECT 6.0, the PARK can no longer be changed manually on the **System settings** page of the OM Web service.

## 5 OMM WEB SERVICE

The OMM acts as an HTTP/HTTPS server. The HTTP server binds to port 80 and HTTPS binds to port 443 by default. A HTTP request on port 80 will be redirected to HTTPS on port 443.

### 5.1 LOGIN

The OMM allows more than one user at a time to configure the system. A user must authenticate with a user name and a password. Both strings are case-sensitive.

With initial installation, or after discarding all settings, the OMM Web service is accessible via a default built-in user account with user “omm” and password “omm”.

System	Customer
PARK	1F102643C7

User name

Password

OK

goahead  
WEB SERVER

With the first login to a new SIP-DECT software version, the user must accept the End User License Agreement (EULA) (see section 5.11).

If the default built-in user account is active, the administrator must change the default account data (passwords) of the “Full access” and “root” account. The meaning of the different account types is described in section 7.17.1.

**Please note:** The OMM forces a change to the default account data. As long as the passwords are unchanged, the OMM will not allow any other configuration.

After login in, the following menus are available (with the **Advanced** option enabled in the top bar):

- **Status** menu: displays the system status (see section 5.3).
- **System** menu: allows configuration of general SIP-DECT system parameters (see section 0).
- **Sites** menu: allows grouping of DECT base stations into different sites (see section 5.5).
- **Base Stations** menu: allows configuration and administration of the attached base stations (see section 5.6).
- **DECT Phones** menu: allows administration of the DECT phones (see section 5.7).
- **WLAN** menu: allows configuration of WLAN parameters (see section 5.8).
- **System Features** menu: allows administration of system features like digit treatment and directory (see section 5.9).
- **Licenses** menu: allows administration of licenses (see section 5.10).

- **Info** menu: displays the End User License Agreement (EULA) (see section 5.11).

## 5.2 LOGOUT

If no user action takes place, the OMM automatically logs the user out after 5 minutes. To log out from the system, click the **Logout** button on the upper right of the OM Web service screen.



## 5.3 “STATUS” MENU

The Status page provides information on the SIP-DECT system status. In case of system errors, system warning messages are also displayed on this page.

Status	General
System	OpenMobility Manager SIP-DECT 6.0RC4 Build 2
Sites	Uptime 20:32
Base Stations	Licenses <span style="color: green;">✔</span>
DECT Phones	Grace period 720:00 <div style="width: 100%; height: 10px; background-color: green;"></div>
WLAN	Standby OMM <span style="color: green;">✔</span>
System Features	IP address 10.37.18.31
Licenses	Number used for visibility checks 25052
Info	OM Integrated Messaging & Alerting service <span style="color: green;">✔</span>
	Base Stations
	Total number 12
	Connected 2 <div style="width: 16.6%; height: 10px; background-color: blue;"></div>
	DECT activated 12
	DECT currently active 2 <div style="width: 16.6%; height: 10px; background-color: blue;"></div>
	DECT clusters 2
	WLAN activated 0
	DECT Phones
	Total number 84
	Subscribed 4 <div style="width: 4.7%; height: 10px; background-color: blue;"></div>
	Subscription allowed <span style="color: red;">✘</span>
	Activate firmware update <span style="color: green;">✔</span>
	Loading firmware from ftp://10.37.18.35/600.dnld
	Firmware version [600: 5.00.SP5.RC1] - [650,602: 6.0.RC8]
	Number of known downloadable DECT phones 4

## 5.4 “SYSTEM” MENU

The System menu comprises general parameters to configure and administer the system parameters of the SIP-DECT solution.

## 5.4.1 “SYSTEM SETTINGS” MENU

The System settings cover global settings for the OpenMobility Manager. You can perform the following tasks from the System Settings menu:

- configure global settings (see the following sub-sections)
- restart the OMM (see section 5.4.1.15)
- update the OMM (see section 5.4.1.16)

The following sections describe the parameters that can be set.

**Note:** The following information describes all parameters visible when the **Advanced** option (in the top bar) is enabled.

### 5.4.1.1 General settings

General settings	
System name	Customer
Remote access	<input checked="" type="checkbox"/>
Tone scheme	US ▼

- **System Name:** Enter the system name.
- **Remote Access:** Switches on/off the SSH access to all DECT base stations of the DECT system. For more information on the SSH access see section 8.3.5.
- **Tone scheme:** Select the country in which the OMM resides. This enables country specific tones (busy tone, dial tone, etc).

### 5.4.1.2 DECT settings

DECT settings	
PARK	1F102643C7 (31100462074346)
DECT power limit 100mW	<input type="checkbox"/>
Encryption	<input type="checkbox"/>
Restrict subscription duration	<input type="checkbox"/>
DECT monitor	<input type="checkbox"/>
Regulatory domain	US (FCC/IC) ▼
DECT authentication code	2222
DECT phone user login type	Number ▼
Preserve user device relation at DB restore	<input type="checkbox"/>

- **PARK:** This setting depends on the licensing mode. Small systems: Enter the PARK code obtained from the PARK service (see section 4.1.3). License file: shows the PARK included in the license file.
- **DECT power limit 100mW:** Limits the DECT base station transmit power to 100mW, independent of the selected regulatory domain. Enable for SIP-DECT installations that are mobile (e.g., on cruise liners that travel between countries). See section 3.11 for more information on this feature.
- **Encryption:** Activate this option if you want to enable DECT encryption for the whole system.

**Please note:** Make sure that all deployed third party DECT phones support DECT encryption. If not, encryption can be disabled per DECT phone (see 6.10.4).

- **Restrict subscription duration:** Activate this option if you want to restrict the duration for DECT phone subscriptions to 2 minutes after subscription activation. This option is not useful in case that you want to subscribe more than one DECT phone at a time or together with auto-create on subscription. It should be activated exclusively in case that there is a special need.
- **DECT monitor:** For monitoring the DECT system behavior of the OpenMobility Manager, the separate DECT monitor application exists. This tool needs an access to the OpenMobility Manager which is disabled by default and can be enabled here. Because of security, the DECT monitor flag is not stored permanently in the internal flash memory of the OMM/DECT base station. After a reset, the DECT monitor flag is ever disabled.
- **Regulatory domain:** Specifies where the IP DECT is used. Supported regulatory domains are:
  - EMEA
  - US (FCC/IC)
  - Brazil
  - Taiwan

Note that 3<sup>rd</sup> generation DECT base stations support different DECT frequencies. These devices can operate in different regulatory domains provided that the **Regulatory domain** setting is configured accordingly.

For older 2<sup>nd</sup> generation DECT base stations, there are different DECT base station models to meet different regulatory domain demands. To setup a North American FCC compliant DECT base station, the value must be set to **US (FCC/IC)**. In a North American US (FCC/IC) deployment, ETSI compliant DECT base stations are made inactive and cannot be activated if the regulatory domain is set to **US (FCC/IC)**. The reverse is also true.

**WARNING:** Please note that selecting the incorrect regulatory domain may result in a violation of applicable laws in your country!

**Note:** Whenever you modify the regulatory domain, a warning is displayed. You must confirm it first to apply the changed setting.

- **DECT authentication code:** The authentication code is used during initial DECT phone subscription as a security option. A code entered here provides a system-wide DECT authentication code for each DECT phone subscription. Alternatively, a DECT phone-specific authentication code can be set (see section 5.7.1).
- **DECT phone user login type:** Specifies the system-wide variant for DECT phone login method. Two kinds of login types are supported: the user can either be determined by the telephone number (**Number**) or by the unique user login ID (**Login ID**). Both elements are part of each user data set.

**Note:** Changing this setting forces an automatic logout of all logged in DECT phones.

- **Preserve user device relation at DB restore:** Enables the preservation of the user – DECT phone association with an OMM database restore. This option is only applicable for database snapshots from SIP-DECT 6.0 or later.

**Note:** If you want to restore the association, enable this option BEFORE uploading a database for an OMM restore. The current OMM value is used, not the setting in the database being uploaded.

### 5.4.1.3 WLAN settings

This setting applies to RFP 42 WLAN and RFP 43 WLAN base stations.

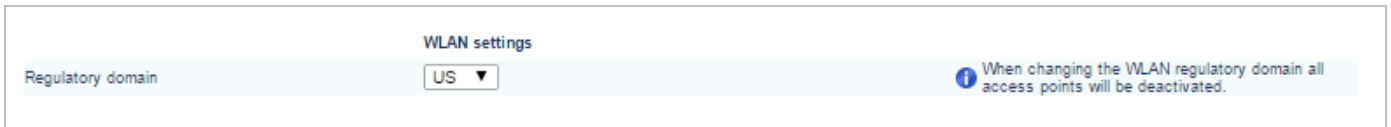

In the **Regulatory domain** field, select the regulatory domain of the WLAN network. This setting depends on the country and is prescribed by the laws of that country. Only the setting prescribed for that country must be used. For more information on the WLAN settings see the sections 5.8 and 7.18.

**WARNING:** Please note that selecting the incorrect regulatory domain may result in a violation of applicable law in your country!

**Note:** Whenever you modify the regulatory domain, a warning is displayed. You must confirm it first to apply the changed setting.

**Please note:** If you upgrade a system to release 3.0 or higher, you must configure the appropriate regulatory domain.

### 5.4.1.4 DECT base stations update

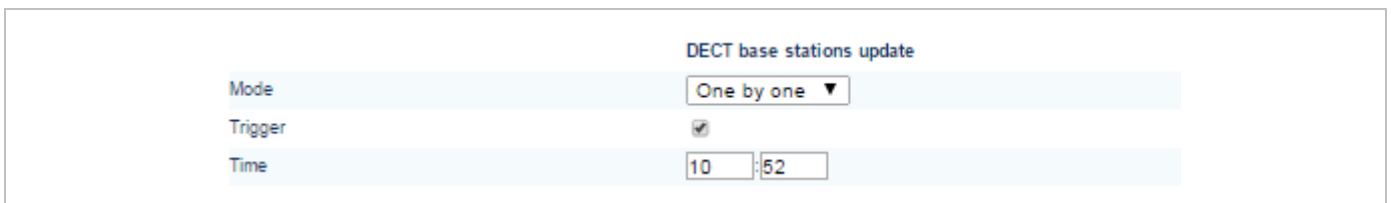

- **Mode:** DECT base station update mode – “One by one” (every single DECT base stations is updated separately) or “All at once” (all DECT base stations are updated in one step)
- **Trigger:** When this option is selected, the DECT base station update is time-controlled.
- **Time:** Time for time controlled updates

### 5.4.1.5 OMP web start

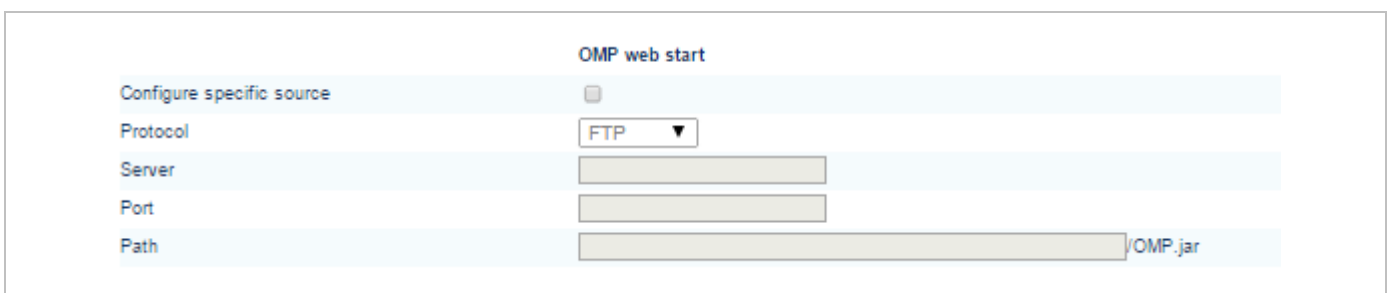



- **Configure specific source:** Enables the specific URL to an external file server for retrieving the OMP jar file.
- **Protocol:** Specifies the protocol used to retrieve the OMP file.
- **Server:** Specifies the IP address or name of the external file server.
- **Port:** Specifies the port of the external file server.
- **Path:** Specifies the location of the OMP jar file on the external file server.

#### 5.4.1.6 DECT phone's firmware update

With SIP-DECT 6.0 or later, the DECT base station software image (iprfr3G.dnld) contains the Mitel 600 DECT phone software. For specific maintenance purposes only, you can configure a URL to use an alternative DECT phone software image. The Mitel 600 DECT phone firmware packages are delivered in the "600.dnld" file for the OMM running on a DECT base station.

- **Activate firmware update:** Enables or disables the "Download over Air" feature. The OMM provides a DECT phone firmware update over the air when this feature is activated. For more information on, see section 7.22.
- **Configure specific source:** Enables the specific URL to an external file server for retrieving the DECT phone firmware file.
- **Protocol:** Specifies the protocol used to retrieve the firmware file from the external server.
- **Server:** Specifies the IP address or name of the external file server.
- **Port:** Specifies the port of the external file server.
- **User name:** Specifies the user name to authenticate on the external file server.
- **Password:** Specifies the password to authenticate on the external file server.
- **Password confirmation:** Confirms the password to authenticate on the external file server.
- **Path:** Specifies the location of the firmware file on the external file server.
- **Use common certificate configuration:** Enables the use of the system-wide certificate validation settings for this URL, as configured on the **System -> Provisioning -> Certificates** page (see section 5.4.2).

### 5.4.1.7 Voice mail

Voice mail	
Voice mail number	<input type="text" value="25711"/>

- **Voice mail number:** Specifies a system-wide voice mail number. This number is used by the Mitel 600 DECT phone family if the voice box is called.

### 5.4.1.8 OM Integrated Messaging & Alerting service

The OpenMobility Manager provides an integrated message and alarm service. The Internal message routing (DECT phone <> DECT phone) can be activated/deactivated. For a detailed description, see /28/.

OM Integrated Messaging & Alerting service	
Internal message routing (phone <> phone)	<input type="checkbox"/>
Configure specific source	<input type="checkbox"/>
Protocol	<input type="text" value="FTP"/>
Server	<input type="text"/>
Port	<input type="text"/>
User name	<input type="text"/>
Password	<input type="text"/>
Password confirmation	<input type="text"/>
Path & filename	<input type="text"/>
Use common certificate configuration	<input type="checkbox"/>

- **Internal message routing (phone <> phone):** Enables or disables internal messaging between DECT phones.
- **Configure specific destination:** Enables the specific URL to an external file server for retrieving the IMA configuration file.
- **Protocol:** Specifies the protocol used to retrieve the IMA configuration file from the external server.
- **Server:** Specifies the IP address or name of the external file server.
- **Port:** Specifies the port of the external file server.
- **User name:** Specifies the user name to authenticate on the external file server.
- **Password:** Specifies the password to authenticate on the external file server.
- **Password confirmation:** Confirms the password to authenticate on the external file server.
- **Path & filename:** Specifies the location and file name of the IMA configuration file on the external file server.
- **Use common certificate configuration:** Enables the use of the system-wide certificate validation settings for this URL, as configured on the **System -> Provisioning -> Certificates** page (see section 5.4.2).

### 5.4.1.9 Syslog

The OMM and the DECT base stations are capable of propagating syslog messages.

- **Active:** Enables or disables collection of syslog messages.
- **IP address:** Address of the host that should collect the syslog messages.
- **Port:** Port of the host that should collect the syslog messages.
- **Forward OMM Messages to syslog:** (Visible only on a PC-hosted OMM system) Enables/disables forwarding of syslog messages from the PC-hosted OMM.

### 5.4.1.10 Software update URL

With SIP-DECT 6.0 or later, DECT base stations in small SIP-DECT systems (~10 RFPs) can obtain their software image from the DECT base station hosting the OMM, if they have no valid URL from which to load their software (see section 7.9.2 for information on URL syntax). If the OMM is running on a DECT base station, the OMM DECT base station delivers the software to the connected DECT base stations.

The new software image for the OMM DECT base station can be provided as an iprpf3G.dnld file on an external file server. You configure the URL for the software image in this section.

- **Configure specific source:** Enables the specific URL for downloading the iprpf3G.dnld file (as opposed to the ConfigURL, which points to an external file server for all configuration and resource files).
- **Protocol:** Specifies the protocol used to fetch the software image file.
- **Port:** Specifies the port of the external file server.
- **Server:** Specifies the IP address or name of the external file server.
- **User name:** Specifies the user name to authenticate on the external file server.
- **Password:** Specifies the password to authenticate on the external file server.
- **Password confirmation:** Confirms the password to authenticate on the external file server.
- **Path:** Specifies the location of the software image file on the external file server.

- **Use common certificate configuration:** Enables the use of the system-wide certificate validation settings for this URL, as configured on the **System -> Provisioning -> Certificates** page (see section 5.4.2).

#### 5.4.1.11 System dump

A system dump is a file that holds information about the OpenMobility Manager and all connected DECT base stations. With the Remote System Dump feature, a system dump is transferred to a remote server. You can configure a specific destination, otherwise the system ConfigURL is used. The system dump is generated manually by pressing the **Dump** button or automatically at the specified time.

Please ensure that the fileserver used allows writing or creation of system dumps.

- **Trigger:** Enables the automatic generation of a system dump time every day at the time specified in the **Time** field.
- **Time:** The time of day the system automatically generates a system dump file (only activated if the **Trigger** checkbox is enabled).
- **Dump:** Immediately triggers the generation of a system dump file.
- **Configure specific source:** Enables the specific URL for transferring the system dump file (as opposed to the ConfigURL, which points to an external file server for all configuration and resource files).
- **Protocol:** Specifies the protocol used to transfer the system dump file.
- **Port:** Specifies the port of the external file server.
- **Server:** Specifies the IP address or name of the external file server.
- **User name:** Specifies the user name to authenticate on the external file server.
- **Password:** Specifies the password to authenticate on the external file server.
- **Password confirmation:** Confirms the password to authenticate on the external file server.
- **Path:** Specifies where the system dump file is stored on the external file server.
- **Use common certificate configuration:** Enables the use of the system-wide certificate validation settings for this URL, as configured on the **System -> Provisioning -> Certificates** page (see section 5.4.2).

### 5.4.1.12 Core dump URL

Fatal software problems may result in memory dumps, in core files. The DECT base station can transfer the core files to a remote fileserver. With SIP-DECT 6.0 or later, you can configure a specific URL to an external file server where core dump files should be transferred and stored. The Core dump URL is used by each DECT base station connected to the OMM.

Without a configured Core dump URL, whether and where core files are transferred is dependent on specific DECT base station settings. Without any special configuration, the files are transferred to the server that is used to retrieve the system software (i.e., the directory of the boot image).

Core dump URL	
Configure specific destination	<input type="checkbox"/>
Protocol	TFTP ▼
Server	<input type="text"/>
Port	<input type="text"/>
User name	<input type="text"/>
Password	<input type="text"/>
Password confirmation	<input type="text"/>
Path	<input type="text" value="/core_&lt;host&gt;_&lt;app&gt;.gz"/>

- **Configure specific destination:** Enables the specific URL to an external file server for transferring and storing core files.
- **Protocol:** Specifies the protocol used to transfer the core files.
- **Server:** Specifies the IP address or name of the external file server.
- **Port:** Specifies the port of the external file server.
- **User name:** Specifies the user name to authenticate on the external file server.
- **Password:** Specifies the password to authenticate on the external file server.
- **Password confirmation:** Confirms the password to authenticate on the external file server.
- **Path:** Specifies the location of the core files on the external file server.

### 5.4.1.13 Net parameters

To allow the prioritization of Voice Packets and/or Signaling Packets (SIP) inside the used network the IP parameter ToS (Type of Service) should be configured.

Net parameters	
ToS for voice packets	B8
ToS for signalling packets	B8
TTL (Time to live)	32

- **ToS for voice packets:** Determines the type of service (ToS resp. DiffServ) byte of the IP packet header for all packets that transport RTP voice streams.
- **ToS for signalling packets:** Determines the type of service (ToS resp. DiffServ) byte of the IP packet header for all packets related to VoIP signaling.
- **TTL (Time to live):** Determines the maximum hop count for all IP packets.

#### 5.4.1.14 Date and time

If OMM DECT base stations start an SNTP client, the date and time of the configured time zone is synchronized with the Mitel DECT 142 / Mitel 142d and Mitel 600 DECT phones. The date and time will be provided by the OMM to these DECT phones if they initiate a DECT location registration. The rules for a time zone can be configured in the **Time zones** menu (see section 5.4.5).

- **NTP server:** The NTP servers used for time synchronization.
- **Time zone:** Specifies the time zone in which the OMM is operating. This feature is exclusively available on the OMM DECT base station. On PC-OMM configurations, the PC time and time zone is used.

#### 5.4.1.15 Restarting the OMM

You can restart the OMM by clicking on the **Restart** button in the top right corner of the **System Settings** page.

- 1 Click on the **Restart** button.

The **Restart** dialog window opens.

- 2 In the **Restart** dialog window, set the following options:

- **Discard OMM DB and configuration files:** Specifies whether OMM database and configuration data is removed from the DECT base station, including the data retrieved from RCS. Local IP configuration remains unaffected. This parameter is only available on an OMM DECT base station.
- **Reset OMM RFP(s) to factory defaults:** Specifies whether all data is removed from the DECT BASE STATION including the OMM database, configuration files and local IP configuration.

**Note:** Both options also affect the standby OMM.

- 3 Click **OK**.

A Restart web page opens and displays a progress bar. The login page is loaded automatically if the OMM is reachable again.

### 5.4.1.16 Updating the OMM

An **Update** button is available on the **System settings** web page. Pressing the **Update** button forces the DECT base stations to check for new software and initiates the software update. For more details about updating the OMM see the section 7.14.

## 5.4.2 "PROVISIONING" MENU

SIP-DECT supports provisioning through external configuration files. With SIP-DECT 6.0 or later, you can configure a URL for an external file server, from which all configuration files can be downloaded. The configured provisioning server URL is used for secure connections to the file server to retrieve configuration or firmware files. For more information on this feature, see section 7.8.1.

The **Provisioning** menu allows you to set parameters for the external provisioning server.

### 5.4.2.1 Current configuration file URL

Current configuration file URL	
URI	-

- **Current configuration file URL:** URL for the configuration file that is currently loaded.

### 5.4.2.2 System credentials

System credentials are used to retrieve configuration and resource files from the configured provisioning server for protocols supporting authentication or servers requesting authentication. For HTTP/HTTPS, basic and digest authentication are supported. System credentials can also be inherited for specific URLs, where no user credentials are specified.

System credentials	
User name	<input type="text"/>
Password	<input type="password"/>
Password confirmation	<input type="password"/>

- **User name:** Specifies the user name for authentication against the provisioning server.
- **Password:** Specifies the password for authentication against the provisioning server
- **Password confirmation:** Confirms the password for authentication against the provisioning server.

### 5.4.2.3 Configuration file URL

**Configuration file URL**

<b>Active</b>	<input type="checkbox"/>	<span style="color: #0070c0; font-weight: bold;">i</span> Changing one of the configuration file URL settings may cause logout of all users!
<b>Protocol</b>	<input type="text" value="HTTPS"/>	
<b>Server</b>	<input type="text"/>	
<b>Port</b>	<input type="text"/>	
<b>Path</b>	<input type="text" value="/ipdect.cfg, ..."/>	

- **Active:** Enables or disables the configuration file URL feature.
- **Protocol:** Specifies the protocol to be used to fetch the configuration files.
- **Server:** Specifies the IP address or name of the provisioning server.
- **Port:** Specifies the provisioning server’s port number.
- **Path:** Specifies the path to the configuration and resource files on the provisioning server.

### 5.4.2.4 Daily automatic reload of configuration and firmware files

**Daily automatic reload of configuration and firmware files**

<b>Active</b>	<input type="checkbox"/>	
<b>Time of day</b>	<input type="text" value="00"/> : <input type="text" value="00"/>	

- **Active:** Enables automatic reload of the configuration and resource files on a daily basis, at the specified time.
- **Time of day:** Time for scheduled reload of configuration and firmware files.

### 5.4.2.5 Certificates

The OMM uses a trusted certificate chain to validate the server. This is required if the server has no certificate derived from a trusted CA root certificate, where the OMM uses the Mozilla CA Certificate List. You can specify the validation methods to be used.

**Certificates**

Trusted certificate(s)	0
Local certificate chain	0
Private key	✘
Private key password	<input type="text"/>
Password confirmation	<input type="text"/>
Delete certificates/key	<input type="button" value="Delete"/>
SSL version	<input type="text" value="Auto"/>
Validate certificates	<input checked="" type="checkbox"/>
Validate expires	<input checked="" type="checkbox"/>
Validate host name	<input checked="" type="checkbox"/>
Allow unconfigured trusted certificates	<input type="checkbox"/>
Import certificates with first connection	<input type="checkbox"/>



- **Trusted certificate(s)**: Read-only; specifies the number of trusted certificates deployed on the OMM.
- **Local certificate chain**: Read-only; specifies the number of local certificate chains deployed on the OMM.
- **Private key**: Read-only; specifies whether a private key file is deployed on the OMM.
- **Private key password**: Specifies a password for the private key file.
- **Password confirmation**: Confirms the password for the private key file.
- **Delete certificates/key**: Allows the user to delete existing certificates and private key files from the OMM.
- **SSL version**: The SSL protocol version to use for the configuration file server connection. Available options are: TLS1.0, TLS1.1, TLS1.2 or AUTO, where AUTO accepts all protocol versions.
- **Validate certificates**: Enables or disables certificate validation. If enabled, the server certificate is validated against trusted CA's (signed by a CA from the Mozilla CA certificate list) and the configured trusted certificates.
- **Validate expires**: Enables or disables the validation of certificate expiry. When this parameter is enabled, the client verifies whether or not a certificate has expired prior to accepting the certificate.
- **Validate host name**: Enables or disables the validation of hostnames on the OMM.
- **Allow unconfigured trusted certificates**: If enabled, this parameter disables any server certificate validation as long as no trusted certificate was imported into the OMM. AXI commands in a received configuration file may import such trusted certificates into the OMM.
- **Import certificates with first connection**: If enabled (in conjunction with the Allow unconfigured trusted certificates parameter), the trusted certificate will be imported from the cert chain delivered in the server response without any validation, as long as no trusted certificate was imported previously into the OMM.

#### 5.4.2.6 Manual import

You can overwrite the hard coded OMM certificate by importing trusted certificates, a local certificate chain and a private key file.

- **Import PEM file with**: Specifies the type of file to be imported (trusted certificate, local certificate, or private key).
- **Import PEM file**: Specifies the location of the file to be imported.

#### 5.4.3 "SIP" MENU

The SIP settings cover all global settings matching the SIP signaling and the RTP voice streams. Parameters are grouped under the tabs described below.

### 5.4.3.1 Basic settings

You can set basic SIP settings for the system on the Basic settings menu.

Basic settings	
Proxy server	<input type="text" value="10.37.44.99"/>
Proxy port	<input type="text" value="5060"/>
Registrar server	<input type="text" value="10.37.44.99"/>
Registrar port	<input type="text" value="5060"/>
Registration period	<input type="text" value="300"/> sec
Globally Routable User-Agent URL	<input checked="" type="checkbox"/>
Outbound proxy server	<input type="text"/>
Outbound proxy port	<input type="text" value="5060"/>
Transport protocol	<input type="text" value="UDP"/>
Local UDP/TCP port range	<input type="text" value="5060"/> - <input type="text" value="5060"/>
Local TLS port range	<input type="text" value="5061"/> - <input type="text" value="5061"/>

- **Proxy server:** IP address or name of the SIP proxy server. If a host name and domain are used for the proxy server parameter, ensure that a DNS server and a domain are specified for your SIP-DECT system via DHCP or the OM Configurator tool.
- **Proxy port:** SIP proxy server's port number. Default is "5060". To enable DNS SRV support for proxy lookups, use a value of "0" for the proxy port. In case that TLS is used, the value shall be changed to "5061".
- **Registrar server:** IP address or name of the SIP registrar. Enables the DECT phones to be registered with a registrar. If a host name and domain are used for the proxy server parameter, ensure that a DNS server and a domain are specified for your SIP-DECT system via DHCP or the OM Configurator tool.
- **Registrar port:** SIP registrar's port number. Default is "5060". To enable DNS SRV support for registrar lookups, use a value of "0" for the registrar port. In case that TLS is used, the value shall be changed to "5061".
- **Registration period:** The requested registration period, in seconds, from the registrar. Default is "3600".
- **Globally Routable User Agent (URL):** Enables support for Globally Routable User-Agent URIs (GRUUs). GRUUs provide a way for anyone on the Internet to route a call to a specific instance of a SIP User-Agent.
- **Outbound proxy server:** This setting is optional. You can enter the address of the outbound proxy server in this field. All SIP messages originating from the OMM are sent to this server. For example, if you have a Session Border Controller in your network, then you would normally set its address here.
- **Outbound proxy port:** The proxy port on the proxy server to which the OMM sends all SIP messages. Default is "5060". In case that TLS is used, the value shall be changed to "5061".
- **Transport protocol:** The protocol used by the OMM to send/receive SIP signaling. Default is "UDP".
- **Local UDP/TCP port range:** The port range to be used for DECT users when UDP/TCP is used as the transport protocol. The default is 5060 – 5060.
- **Local TLS port range:** The port range to be used for DECT users when TLS is used as the transport protocol. The default is 5061 – 5061.

There are certain rules to note when configuring port ranges; see section 3.17 for more information.

### 5.4.3.2 Advanced settings

You can set more advanced SIP settings for the system on the Advanced settings menu.

Advanced	
Explicit MWI subscription	<input checked="" type="checkbox"/>
User agent info	<input checked="" type="checkbox"/>
Dial terminator	<input type="text" value="#"/>
Registration failed retry timer	<input type="text" value="120"/> sec
Registration timeout retry timer	<input type="text" value="120"/> sec
Session timer	<input type="text" value="0"/> sec
Transaction timer	<input type="text" value="4000"/> msec
Blacklist time out	<input type="text" value="5"/> min
Incoming call timeout	<input type="text" value="180"/> sec
Determine remote party by	<input type="text" value="P-Asserted-Identity"/> header
Multiple 180 Ringing	<input checked="" type="checkbox"/>
Semi-attended transfer mode	<input type="text" value="Blind"/>
Refer-to with replaces	<input type="checkbox"/>
SIP Contact matching	<input type="text" value="URL"/>
Call reject state code (user reject)	<input type="text" value="486"/>
Call reject state code (device unreachable)	<input type="text" value="486"/>

- **Explicit MWI subscription:** Some SIP Call Managers such as the Asterisk support Message Waiting Indication (MWI) based on /21/. An MWI icon is displayed on a DECT phone (Mitel DECT 142 / Mitel 142d, Mitel 600) if the user has received a voice message on his voice box which is supported by the SIP Call Manager. If **Explicit MWI subscription** is enabled, the OMM sends explicit for each DECT phone an MWI subscription message to the Proxy or Outbound Proxy Server.
- **User agent info:** If this option is enabled, the OMM sends information on his version inside the SIP headers *User-Agent/Server*.
- **Dial terminator:** The dial terminator is configurable (up to 2 characters; “0” – “9”, “\*”, “#” or empty). The default dial terminator is “#”. A dial terminator is necessary if digit treatment shall be applied on outgoing calls and overlapped sending is used.
- **Registration failed retry timer:** Specifies the time, in seconds, that the OMM waits between registration attempts when the registration is rejected by the registrar. Default is “1200” seconds.
- **Registration timeout retry timer:** Specifies the time that the OMM waits between registration attempts when the registration timed out. Default is “180” seconds.
- **Session timer:** The interval, in seconds, between re-INVITE requests sent from the OMM to keep a SIP session alive. The minimum session timer is 90 seconds and the maximum is 86400 seconds. The default is 0 (i.e., feature is disabled).
- **Transaction timer:** The time period in milliseconds that the OMM allows a call server (proxy/registrar) to respond to SIP messages that it sends. If the OMM does not receive a response in the time period designated for this parameter, the OMM assumes the message as timed out. In this case the call server is recorded to the blacklist. Valid values are “4000” to “64000”. Default is “4000” milliseconds.
- **Blacklist time out:** The time period in minutes an unreachable call server stays in the blacklist. Valid values are “0” to “1440”. Default is “5” minutes.

- **Incoming call timeout:** The time, in seconds, that the OMM waits for a user to accept an incoming call before rejecting the call automatically. The minimum time is 30 seconds and the maximum is 300 seconds. The default is 180 seconds.
- **Determine remote party by:** You can select the SIP header from which the remote party information (user id and display name) should be determined. If **P-Asserted-Identity** (default value) is selected but no such header is received, a fallback to the mandatory **From / To** header will be done. This feature can be configured by choosing one of the two values.

**Note:** When SIP-DECT receives a SIP header **P-Asserted-Identity** in ringing state during an outgoing call, the included identity information (e.g. SIP display name and user-id) will be displayed on Mitel 600 and Mitel 142d phones as new call target. In addition, the outgoing call log of the Mitel 600 and Mitel 142d phones will be updated with the new given identity.

- **Multiple 180 Ringing:** If this feature is deactivated, the OMM sends out only one 180 Ringing response for an incoming call if PRACK is not supported. If this feature is activated, the OMM retransmits multiple times the 180 Ringing response for an incoming call if PRACK is not supported. This ensures that the calling side receives a 180 Ringing response in case of packet losses on the network. By default this feature is active.
- **Semi-attended transfer mode and Refer-to with replaces:**

Semi-attended transfer mode	Refer-to with replaces	Behavior
Blind	No	The semi-attended transfer is handled as a blind transfer. The phone sends CANCEL before REFER for semi-attended transfer.
Blind	Yes	The semi-attended transfer is handled as a blind transfer. The phone sends REFER with Replaces for semi-attended transfer and no CANCEL. This behavior is not SIP compliant but necessary for some iPBX platforms.
Attended	-	The semi-attended transfer is handled as an attended transfer. Both lines of the transferor remain active until the transfer succeeds. This behavior is compliant to RFC 5589.

**Please note:** The mode “Semi-attended transfer mode: Blind” with “Refer-to with replaces: yes” is not SIP compliant and should only be used on iPBX platforms that require this type of signaling.

- **SIP contact matching:** Specifies the method used by the OMM to match the Contact header in a SIP response to a REGISTER request. Available options are:
  - **URI** – match user username, domain name, phone IP and port and transport
  - **IP only** – match the IP address of the phone only
  - **Username only** – match the username only
  - **IP and user name** – match the IP address of the phone and the username
 The default is **URI**.
- **Call reject state code (user reject):** Specifies the SIP state code sent as response when the user rejects an incoming call by pressing the “Reject” option. Valid values are “400” to “699”. The default is “486”

- **Out of range state code (device unreachable):** Specifies the SIP state code sent as response when the incoming call is rejected because the DECT phone is unreachable (e.g., the DECT phone is out of range or out of battery power). Valid values are “400” to “699”. The default is 486.

### 5.4.3.3 RTP settings

You can set RTP parameters in the RTP settings section.

RTP settings	
RTP port base	<input type="text" value="16320"/>
Preferred codec 1	<input type="text" value="G.711 u-law"/>
Preferred codec 2	<input type="text" value="G.711 A-law"/>
Preferred codec 3	<input type="text" value="G.729 A"/>
Preferred codec 4	<input type="text" value="G.722"/>
Preferred packet time	<input type="text" value="10"/> msec
Silence suppression	<input type="checkbox"/>
Receiver precedence on codec negotiation	<input type="checkbox"/>
Eliminate comfort noise packets	<input type="checkbox"/>
Single codec reply in SDP	<input type="checkbox"/>

- **RTP port base:** Each RFP needs a continuous port area of 68 UDP ports for RTP voice streaming. The RTP port base is the start port number of that area. Default is “16320”.
- **Preferred codec 1 – 4:** Specifies a customized codec preference list which allows you to use the preferred codecs. The *Codec 1* has the highest and *Codec 4* the lowest priority.
  - Note:** With SIP-DECT Release 3.0 or higher the voice codecs G.722 (wideband), G.711 u-law, G.711 A-law and G.729 A are supported. The previously supported codec G.723 is no longer available.
- **Preferred packet time (10, 20 or 30 msec):** Determines the length of voice samples collected before sending out a new RTP packet. A small setting improves voice quality at the expense of data transmission overhead. Default is “20” milliseconds.
- **Silence suppression:** Enables automatic silence detection in the RTP voice data stream to optimize the data transfer volume.
- **Receiver precedence on CODEC negotiation:**
  - The ON (option is enabled) setting means:  
The CODEC selection for incoming SDP offers based on the own preference order list. The first entry in the OMM preferred codec list matching an entry in the incoming SDP offer will be selected.
  - The OFF (option is disabled) setting means:  
The CODEC selection based on the preference order list of incoming SDP offer. The first entry in the incoming order list matching an entry of OMM preferred codec list will be selected. This is the default and is as recommended in RFC 3264.
- **Eliminate comfort noise packets:** If this feature is activated, then comfort noise packets are removed from the RTP media stream which causes gaps in the sequence numbers. This can be used if comfort noise packets e.g. in G.711 media streams disturb voice calls in certain installations.
- **Single codec reply in SDP:** If this feature is activated, the OMM answers to SDP offers (included in the SIP signaling) with a single codec in the SDP answer.

### 5.4.3.4 DTMF settings

You can set DTMF parameters in the DTMF section.

DTMF settings	
Out-of-band	<input checked="" type="checkbox"/>
Method	RTP(RFC 2833) ▼
Payload type	101

- **Out-of-band:** Used to configure whether DTMF Out-of-band is preferred or not.
- **Method:** The OMM supports the following DTMF Out-of-band methods:
  - RTP (RFC 2833)  
Transmits DTMF as RTP events according to RFC 2833 (/14/) after the payload type negotiation via SIP/SDP. If the payload type is not negotiated, "in band" will be used automatically.
  - INFO  
The SIP INFO method is used to transmit DTMF tones as telephone events (application/dtmf-relay). This setting should be used if RFC 2833 is not supported.
  - BOTH  
DTMF telephones events are send according to RFC 2833 and as well as SIP INFO method. **Note:** Possibly, the other party recognizes events twice.
- **Payload type:** If the **Out-of-band** option is enabled, this setting specifies the payload type which is used for sending DTMF events based on section 3.1, reference /14/.

### 5.4.3.5 Registration traffic shaping

Registration traffic shaping parameters allow you to limit the number of simultaneous SIP registrations at startup/fail over of the OMM. This feature is always activated because disabling it may overload the OMM or the call server.

Some providers use a keep-alive mechanism based on SIP registration renewals for remote endpoints that are behind a Network Address Translator (NAT), as in an IP-Centrex solution. The keep-alive mechanism keeps the pinhole open and ensures communication between the remote endpoint and the Session Border Controller (SBC).

The OMM feature that spreads the registration renewals to prevent bottlenecks in large systems is not compatible with the keep-alive mechanism. With SIP-DECT 6.0 or later, you can disable the spread mechanism and configure a registration renewal timer to allow support for the NAT feature.

Registration traffic shaping	
Simultaneous registrations	4
Waiting time	0 msec
Spread registration renewals	<input checked="" type="checkbox"/>
Renewal timer	15 sec

- **Simultaneous registrations:** The maximum number of simultaneously started registrations.
- **Waiting time:** The waiting time between a registration finish and starting the next registration in ms (0-1000ms).

- **Spread registration renewals:** If set to ON, the OMM distributes all DECT phone registration renewals automatically, between half-way through the registration period and 30 seconds before expiry. This prevents registration renewal bottlenecks. Default is ON.
- **Renewal timer:** The time, in seconds, during which the OMM renews DECT phone registrations before expiry (if “Spread registration renewals” is set OFF). The DECT phone automatically sends registration renewals half-way through the registration period, unless the half-way point is greater than the threshold value. For example, if the threshold value is set to 60 seconds and the registration period is 600 seconds, the phone sends the renewal REGISTER message 60 seconds prior to the expiration of the registration period. If the registration period is 100 seconds, the renewal is sent at the half-way point as  $(100/2) < 60$ . Valid values are 0 to 2147483647. Default is 15.

### 5.4.3.6 Supplementary Services

The Supplementary Services section contains various parameters related to call control.

Supplementary Services	
Call forwarding / Diversion	<input checked="" type="checkbox"/>
Local line handling	<input checked="" type="checkbox"/>
Automatic ringback on hold call	<input checked="" type="checkbox"/>
Call transfer by hook on (Mitel 800)	<input checked="" type="checkbox"/>
Call transfer by hook (Mitel 142)	<input type="checkbox"/>
Truncate Caller Indication after ':'	<input type="checkbox"/>
SIP reRegister after 2 active OMM failover	<input type="checkbox"/>
Call release timeout	<input type="text" value="5"/> sec
Hold call release timeout	<input type="text" value="5"/> sec
Failed call release timeout	<input type="text" value="5"/> sec

- **Call forwarding / Diversion:** The DECT phone user can (de)activate call forwarding/diversion in the OMM via DECT phone menu. In some installations the implemented call forwarding/diversion feature in the IPBX system is in conflict with the OMM-based call forwarding/diversion. Thus, the OMM-based call forwarding/diversion can be deactivated to let the menu on the DECT phone disappear. This setting becomes active on DECT phones with the next DECT “Locating Registration” process (can be forced by switching the DECT phone off and on again). Call forwarding that is already activated is ignored if the call forwarding feature is deactivated.
- **Local line handling:** In some installations the implemented multiple line support in the IPBX system is in conflict with the OMM based multiple line support. Thus, the OMM based multiple line support can be deactivated. Note, that the OMM based multiple line support is active by default.

A deactivation of the “Local line handling” flag results in the following implications:

- Only one line is handled for each user (except for an SOS call <sup>1</sup>)
- If a user presses the “R” key or hook-off key in a call active state, a DTMF event is send to the IPBX via SIP INFO including signal 16 (hook-flash). All Hook-flash events are sent in every case via SIP INFO, independent of the configured or negotiated DTMF method during call setup. All other key events are sent via the configured or negotiated DTMF method.

<sup>1</sup> The OM SOS call feature is unchanged. The initiation of a SOS call in call active state results in the creation of a new line which handles the SOS call.

- The OMM-based call features “Call waiting”, “Call Transfer”, “Brokering” and “Hold” are no longer supported.
- This setting becomes active on DECT phones with the next DECT “Locating Registration” process (can be forced by switching the DECT phone off and on again).
- **Automatic ringback on hold call:** Enables or disables a ringback on the loudspeaker if the B party of the active line releases the call. The ringing begins after the call release timeout interval (see description below).
- **Call transfer by hook on (Mitel 600):** Enables call transfer via the hook key on a Mitel 600 DECT phone (in addition to call transfer via menu).
- **Call transfer by hook on (Mitel 142):** Enables call transfer via the hook key on a Mitel 142 DECT phone (in addition to call transfer via menu).
- **Truncate Caller Indication after ‘;’:** If the user name info in SIP to-/from-/contact headers or p-asserted-identity is extended by a suffix, which is separated by a semicolon, this suffix is truncated before the username is printed to call displays or DECT phone internal call logs.
- **SIP reRegister after 2 active OMM failover:** Enables SIP re-registration of all users from the active OMM when the system detects two active OMMs (in a failover scenario).
- **Call release timeout:** Specifies the time, in seconds, after which an active line is released if the DECT phone user has not gone on-hook after the B party on an active call releases the call.
- **Hold call release timeout:** Specifies the time, in seconds, after which the active line is released if the DECT phone user has not switched to a held line (when the B party on a held call releases the call).
- **Failed call release timeout:** Specifies the time, in seconds, after which an active line is released if the called party is busy, or the call is rejected for any reason.

#### 5.4.3.7 Intercom Push-to-talk-Outgoing calls/Incoming calls

You can set global auto-answer settings in the Intercom Push-to-talk section. For more information on this feature, see section 3.31.

Intercom/Push-to-Talk - Outgoing calls	
Initialization prefix for Push-to-talk	<input type="text"/>
Intercom/Push-to-Talk - Incoming calls	
Auto answer	<input checked="" type="checkbox"/>
Microphone mute	<input checked="" type="checkbox"/>
Warning tone	<input checked="" type="checkbox"/>
Allow barge in	<input checked="" type="checkbox"/>

#### Outgoing calls

- **Initialization prefix for Push-to-talk:** String to be entered when initiating an intercom call. An empty string indicates that the DECT phone cannot initiate an intercom call.

#### Incoming calls

- **Auto answer:** Enables or disables auto-answer on incoming calls.
- **Microphone mute:** Enables or disables microphone muting when incoming calls are automatically answered.



- **Warning tone:** Enables or disables warning tone on incoming call. A short ringtone is played if there are no active calls. If there is an active call in a “barge in” situation, the ringing will be in-band
- **Allow barge in:** Allows/disallows “barge-in” on existing calls.

### 5.4.3.8 Security

You can set security-specific settings in the Security section.

- **Persistent TLS keep alive timer active:** When enabled and “Persistent TLS” is selected as transport protocol, the OMM sends out keep alive messages periodically to keep the TLS connection open.
- **Persistent TLS keep alive timer timeout:** Specifies the time pattern, in seconds, in which the OMM sends out keep-alive messages. Valid values are “10” to “3600”. Default is “30” seconds.
- **Send SIPS over TLS active:** When enabled, and “TLS” or “Persistent TLS” is selected as transport protocol, the OMM uses SIPS URIs in the SIP signaling. Default is “ON”.
- **TLS-Authentication:** When enabled and “TLS” or “Persistent TLS” is selected as transport protocol, the OMM validates the authenticity of the remote peer via exchanged certificates and the configured “Trusted certificates”. Default is “ON”.
- **TLS-Common-Name-Validation:** When enabled and “TLS authentication” is selected, the OMM validates the “Alternative Name” and “Common Name” of the remote peer certificate against the configured proxy, registrar and outbound proxy settings. If there is no match, an established TLS connection will be closed immediately.
- **Trusted certificate(s):** The number of imported trusted certificates (read-only).
- **Local certification chain:** Indicates the number of imported certificates in the local certificate chain (read-only).
- **Private key:** Indicates whether the OMM has a private key file (read-only).
- **Delete certificates/key:** Allows deletion of all certificates and the local key.

### 5.4.3.9 Certificate server

Set the parameters on the Certificate server tab to automatically import Trusted, Local Certificates and a Private Key files from an external server for SIP signaling.

The screenshot shows a configuration form titled "Certificate server". It contains the following fields and controls:

- Active:** A checkbox that is currently unchecked.
- Protocol:** A dropdown menu with "HTTPS" selected.
- Server:** A text input field.
- Port:** A text input field.
- User name:** A text input field with a note: "If not configured, system credentials are used!".
- Password:** A text input field.
- Password confirmation:** A text input field.
- Path:** A text input field.
- Use common certificate configuration:** A checkbox that is currently unchecked.
- Trusted certificates file:** A text input field.
- Local certificate chain file:** A text input field.
- Private key file:** A text input field.

- **Active:** Enables the feature.
- **Protocol:** Specifies the preferred protocol (FTP, TFTP, FTPS, HTTP, HTTPS, SFTP)
- **Server:** Specifies the name or IP address of the external file server.
- **User name:** Specifies the user name to authenticate against the external file server.
- **Password:** Specifies the password to authenticate against the external file server.
- **Password confirmation:** Confirms the password to authenticate against the external file server.
- **Path:** Specifies the path on the file server to the certificate files.
- **Trusted certificate file:** Specifies the name of the PEM file on the specified server, including the trusted certificates.
- **Local certificate file:** Specifies the name of the PEM file on the external server including the local certificate or a certificate chain.
- **Private key file:** Specifies the name of the PEM file on the external server including the local key.
- **Port:** Specifies the certificate server's port number.
- **Use default port:** If selected, the default port associated with the selected protocol is used.
- **Use common certificate configuration:** Enables the use of the system-wide certificate validation settings, as configured on the **System -> Provisioning -> Certificates** page (see section 5.4.2.5).

### 5.4.3.10 Manual import

Set the parameters for manual import of certificate keys.

The screenshot shows a form titled "Manual import" with the following elements:

- Import PEM file with:** A dropdown menu with "Trusted certificate(s)" selected.
- Import PEM file:** A "Choose file" button next to the text "No file chosen".
- Import:** A button to trigger the import process.

- **Import PEM file with:** Allows selection of the kind of certificate/key to be imported.
- **Import PEM file:** Specifies the file to be imported.
- **Import:** Triggers an import of the file

### 5.4.4 “USER ADMINISTRATION” MENU

After initial installation or after removing the configuration file, the OMM Web service is accessible via a built-in user account with user “omm” and password “omm”.

If the default built-in user account is active, the administrator must change the default account data of the “Full access” and “Root (SSH only)” account. The meaning of the different account types is described in section 7.17.1.

**Please note:** The OMM forces you to change the default account data. As long as the passwords are unchanged, the OMM will not allow any other configuration.

These settings are case sensitive and can be changed on the **User administration** web page.

The screenshot shows a web form titled "User Administration" with "Local user account" as a sub-header. At the top are "OK" and "Cancel" buttons. The form fields are as follows:

- Account type:** A dropdown menu currently set to "Full access".
- Active:** A checkbox that is checked.
- User name:** A text input field containing "omm".
- Old password:** An empty text input field.
- Password:** An empty text input field.
- Password confirmation:** An empty text input field.
- Password aging:** A dropdown menu currently set to "None".

- **Account type:** Select the account type you wish to change.
- **Active:** This setting applies to the **Read-only access** account. Using this account, a user is not allowed to configure any item of the OMM installation. The account can be deactivated.
- **User name:** If desired, enter a new user name.
- **Old password:** Related to the “Full Access Account”, to change the password the old password must be typed in again.
- **Password, Password confirmation:** Enter the appropriate data in these fields.

The OMM has several rules to check the complexity of the new password. A new password will not be accepted if:

- the new password is not five or more characters long
- the new password does not contain characters from at least three of the following groups: lower case, upper case, digits or other characters
- the new password has 50% or more of the same character ('World11111' or 'W1o1r1l1d1')
- the new password contains one of the following items (either upper or lower case as well as forward or backward):
  - account name
  - host name (IP address)
  - old password
  - some adjoining keystrokes (e.g. 'qwerty')
- **Password aging:** A timeout for the password can be set. Select the duration, the password should be valid.

### 5.4.5 “TIME ZONES” MENU

**Note:** This menu is only available if the OMM resides on an RFP.

On the **Time zones** page, the OMM provides all available time zones. They are set with their known daylight savings time rules adjusted to the Universal Coordinated Time (UTC) per default. The difference to the UTC time is shown in the **UTC difference** column. In case of a configured daylight savings time rule (**DST** column) this is also marked for each time zone.



The screenshot shows the 'Time Zones' menu with a 'Default' button and a list of 118 time zones. The table below represents the data shown in the screenshot:

Name	ID	UTC difference	DST
 Africa Central West	AFC	+1 h	✗
 Africa Central East	AFD	+2 h	✗
 Africa East	AFE	+3 h	✗
 Afghanistan	AFG	+4.50 h	✗
 Africa West	AFW	0 h	✗
 Alaska	AK	-9 h	✓
 Aleutian Islands	AKW	-10 h	✗
 Armenian Standard Time	ARM	+4 h	✓

The date and time are provided by the OMM to the Mitel 142 and Mitel 600 DECT phones if the DECT phone initiates a DECT location registration. This will be done in the following cases:

- subscribing to the OMM
- entering the network again after the DECT signal was lost
- power on
- silent charging feature is active at the phone and the phone is taken out of the charger
- after a specific time to update date and time

The following tasks can be performed on the **Time zones** page:

- changing the time zones (see section 5.4.5.1)
- resetting time zones (see section 5.4.5.2)

#### 5.4.5.1 Changing Time Zones

It is possible to change the time zone rules for maximal five time zones. Changed rules are marked with a bold time zone name in the table. The changes are saved in the configuration file and are restored after each OpenMobility Manager startup.

- 1 To change the settings of a time zone, click on the  icon left behind the time zone entry.  
The **Configure time zone** dialog opens.
- 2 You can change the standard time and the daylight savings time (DST) of a time zone. If the time zone has no DST, only the UTC difference can be configured. For the DST both points of time (begin of standard time and begin of daylight savings time) must be specified exactly. Therefore a certain day in the month or a certain week day in a month can be used. See the following screenshot as an example:

Configure time zone

Time zone	
Name	Africa Central West
ID	AFC
<b>Standard time</b>	
UTC difference	60 min
Month	0 (0 = Not used)
Day	0 (0 = Not used)
Day of week	0 (0 = Not used 1 = Sunday 7 = Saturday)
Week	0 (0 = Not used, 1 = First, 5 = Last)
Hour	0
Minute	0
<b>Daylight savings time</b>	
Standard time difference	0 min
Month	0 (0 = Not used)
Day	0 (0 = Not used)
Day of week	0 (0 = Not used 1 = Sunday 7 = Saturday)
Week	0 (0 = Not used, 1 = First, 5 = Last)
Hour	0
Minute	0

OK Cancel

### 5.4.5.2 Resetting Time Zones

To reset individual time zone settings, press the **Default** button on the **Time zones** web page. This sets all time zones back to the default values and deletes the changed time zone rules in the configuration file.

### 5.4.6 “SNMP” MENU

To manage a larger RFP network, an SNMP agent is provided for each RFP. This will give alarm information and allow an SNMP management system (such as “HP Open View”) to manage this network. On the **SNMP** page of the OMM Web service you configure the SNMP service settings.

SNMP

OK Cancel

General settings	
Read-only community	<input type="text"/>
System contact	<input type="text"/>
<input type="checkbox"/>	
Trap handling	
Trap community	<input type="text"/>
Trap host IP address	<input type="text"/>

You can configure the following SNMP parameters using the OMM web service:

### General settings

- **Read-only community:** The SNMP community string forms a password that is sent by the SNMP management system when querying devices. The query is answered only if the SNMP community string matches. You may use “public” as a default keyword for read-only access.
- **System contact:** Enter a descriptive text that typically is displayed in the SNMP management software.

### Trap handling

Activate the checkbox behind the **Trap handling** section to enable this feature.

- **Trap community:** This community string is used if the SNMP agent informs the SNMP management system about events (traps).
- **Trap host IP address:** Enter the IP Address that the SNMP agent uses to send traps.

### Further notes

- The RFP needs an initial (one-time) OMM connection to receive its SNMP configuration. In case of a reset, this configuration does not change. Changing the SNMP configuration on the OMM forces all agents to be reconfigured.
- The agent does not support MIB-II write access, SNMPv2-MIB read/write access, NET-SNMP-MIB read/write access, NET-SNMP-AGENT-MIB read/write access and SNMPv3.
- For background information on using SNMP with the SIP-DECT system see section 7.19.

## 5.4.7 “DB MANAGEMENT” MENU

The database management (DB) menu allows flexible backup and restore management of the OMM database. The OMM database contains all configuration settings which are configurable via the OMM Web service interface.

The OMM database can be

- manually imported from the Web browser’s file system or from an external server (see section 5.4.7.1),
- manually exported to the Web browser’s file system or to an external server (see section 5.4.7.2),
- automatically exported to an external server when configuration modifications are done (see section 5.4.7.3).

**Note:** The OMM database is saved in a compressed file in a proprietary format. Any modification of this file outside the OMM is not allowed.

The following protocols for the transport to or from an external server are supported:  
FTP, TFTP, FTPS, HTTP, HTTPS, SFTP.

### 5.4.7.1 Manual Database Import

**Please note:** A manual import of a database results in a reset of the OMM.

The screenshot shows a web form titled "Database management" with a sub-section "Manual import". The form contains the following elements:

- Protocol:** A dropdown menu currently set to "FILE".
- Server:** A text input field.
- Port:** A text input field.
- User name:** A text input field.
- Password:** A text input field.
- Password confirmation:** A text input field.
- File:** A section containing a "Choose file" button and the text "No file chosen".
- Use common certificate configuration:** A checkbox that is currently unchecked.
- Load:** A button at the bottom of the form.

In the **Manual import** section of the **Database management** page enter the following:

**1 Protocol:**

- To import a database from the Web browser’s file system the protocol **FILE** must be selected.
- To import a database from an external server select the preferred protocol (e.g. HTTP).

**2 Server:** IP address or the name of the external server.

**3 User name, Password** (in case of import from an external server): If necessary, enter the account data of the server.

**4 File:** Path and file name which include the OMM database. If you have selected the **FILE** protocol, the **Browse** button is displayed and you can to select the file from the file system.

**5 Use common certificate configuration:** Enables the use of the system-wide certificate validation settings, as configured on the **System -> Provisioning -> Certificates** page (see section 5.4.2.5).

**6** Press the **Load** button.

Before the OMM accepts the database, a validation check is performed. If the database is verified as valid, the OMM will be reset to activate the new database.

**Please note:** After the reset, all configuration in the restored database takes effect with the exception of the user account settings. The user account settings can be only modified locally via the OMM Web service and are never restored by a database import.

### 5.4.7.2 Manual Database Export

The screenshot shows a web form titled "Manual export". It contains the following fields and controls:

- Protocol:** A dropdown menu with "FILE" selected.
- Server:** An empty text input field.
- Port:** An empty text input field.
- User name:** An empty text input field.
- Password:** An empty text input field.
- Password confirmation:** An empty text input field.
- File:** A text input field containing the path "/150304\_Customer\_1F102643C7\_omm\_conf.gz".
- Use common certificate configuration:** A checkbox that is currently unchecked.
- Save:** A button at the bottom of the form.

In the **Manual export** section of the **Database management** page enter the following:

- 1 **Protocol:** Select the preferred protocol. If you want to export the database to the Web browser's file system, select the **FILE** setting.
- 2 **Server:** Enter the IP address or the name of the server.
- 3 **User name, Password:** If necessary, enter the account data of the server.
- 4 **File:** Enter the path and filename where the database is to be saved.
- 5 **Use common certificate configuration:** Enables the use of the system-wide certificate validation settings, as configured on the **System -> Provisioning -> Certificates** page (see section 5.4.2.5).
- 6 Press the **Save** button.

### 5.4.7.3 Automatic Database Export

The automatic database export feature allows an automatic database backup to an external server for each configuration modification. If this feature is activated, the OMM transfers a backup file to a configured external server any time configuration changes occur (e.g. DECT phone subscription). The backup file overwrites any existing backup files.

**Please note:** Synchronization with an NTP server is mandatory for an automatic database export. For NTP server configuration see section 7.5.4 and section 7.6.

The screenshot shows a web form titled "Automatic export". It contains the following fields and controls:

- Active:** A checkbox that is currently unchecked.
- Protocol:** A dropdown menu with "HTTP" selected.
- Server:** An empty text input field.
- Port:** An empty text input field.
- User name:** An empty text input field.
- Password:** An empty text input field.
- Password confirmation:** An empty text input field.
- File:** A text input field containing the path "/150304\_Customer\_1F102643C7\_omm\_conf.gz".
- Use common certificate configuration:** A checkbox that is currently unchecked.
- OK:** A button at the bottom of the form.



In the **Automatic export** section of the **Database management** page enter the following:

- 1 **Active:** Activate this option to enable the automatic export feature.
- 2 **Protocol:** Select the preferred protocol.
- 3 **Server:** Enter the IP address or the name of the server.
- 4 **Port:** Enter the port of the server.
- 5 **User name, Password:** If necessary, enter the account data of the server.
- 6 **File:** Enter the path and filename where the database is to be saved.

The OMM writes the database into a file on the external server with following name convention:

<yymmdd>\_<system\_name>\_<PARK>\_omm\_conf.gz

If the system name contains non-standard ASCII character then these character are replaced by “\_”.

- 7 **Use common certificate configuration:** Enables the use of the system-wide certificate validation settings, as configured on the **System -> Provisioning -> Certificates** page (see section 5.4.2.5).
- 8 Press the **OK** button.

### 5.4.8 “EVENT LOG” MENU

The **Event log** page displays important event information on OMM system functions, e.g. security aspects. A more detailed system log is available by configuring the **Syslog** function in the **System settings** menu (see section 5.4.1.9).

Event Log

Severity	Count	Time (UTC)	Event
3	6	2015/01/23 22:20:50.431	DSIP: SIP registration to 10.37.44.99 failed - timed out
2	1	2015/01/23 05:11:52.491	AXI : [203/omm] Remote host closed connection (10.8.4.180:2621) / Last rcv: Request / Last snd: Response
3	2	2015/01/23 04:57:04.135	DSIP: SIP registration to 10.37.44.99 failed - timed out
2	1	2015/01/23 03:46:11.018	AXI : [203] New secure connection from 10.8.4.180:2621
3	1	2015/01/23 00:03:38.777	DSIP: SIP registration to 10.37.44.99 failed - timed out
2	1	2015/01/22 19:14:11.920	AXI : [203/omm] Remote host closed connection (10.8.4.88:7246) / Last rcv: Request / Last snd: Response
2	1	2015/01/22 18:19:01.431	AXI : [203] New secure connection from 10.8.4.88:7246
2	1	2015/01/22 17:38:20.471	AXI : [203/omm] Connection closed: 10.8.4.88:2438 / Last rcvRequest / Last sndResponse
3	1	2015/01/22 17:38:20.470	AXI : [ 203] Disconnect client (10.8.4.88) because of elapsed client inactivity timer
2	1	2015/01/22 15:20:59.585	AXI : [202] New secure connection from 10.37.18.35:61027
2	1	2015/01/22 15:19:26.962	AXI : [202/omm] Remote host closed connection (10.37.18.35:56482) / Last rcv: Request / Last snd: Response
2	1	2015/01/22 14:58:21.104	AXI : [203] New secure connection from 10.8.4.88:2438
3	1	2015/01/22 11:46:19.980	DSIP: SIP registration to 10.37.44.99 failed - timed out
2	1	2015/01/22 11:30:35.483	AXI : [203/omm] Connection closed: 10.8.4.226:42845 / Last rcvRequest / Last sndResponse
3	1	2015/01/22 11:30:35.482	AXI : [ 203] Disconnect client (10.8.4.226) because of elapsed client inactivity timer

To clear the display, press the **Clear** button.

## 5.5 “SITES” MENU

DECT base stations can be grouped into different sites. A site consists of the following parameters:

- **ID:** Identification number of the site.
- **Name:** The name of the site.
- **Hi-Q Audio Technology, SRTP, Enhanced DECT Security:** Indicates whether (one of) these features are enabled for the site.
- **Base stations:** The number of base stations assigned to the site.

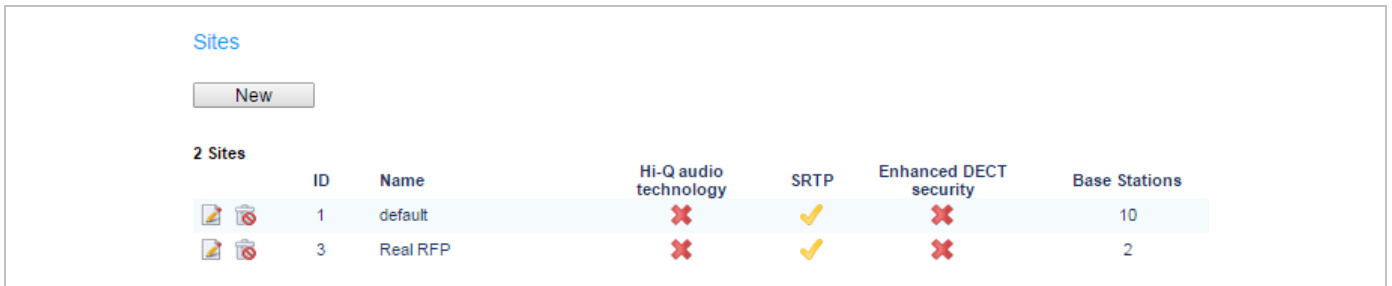

The screenshot shows a 'Sites' menu with a 'New' button and a table listing 2 sites. The table has columns for ID, Name, Hi-Q audio technology, SRTP, Enhanced DECT security, and Base Stations.

ID	Name	Hi-Q audio technology	SRTP	Enhanced DECT security	Base Stations
1	default	✗	✓	✗	10
3	Real RFP	✗	✓	✗	2

You can perform the following tasks:

- create a new site (see section 5.5.1)
- edit a site (see section 5.5.2)
- delete a site (see section 5.5.3)

### 5.5.1 CREATING A NEW SITE

1 On the **Sites** page press the **New** button.

The **Configure site** dialog opens.

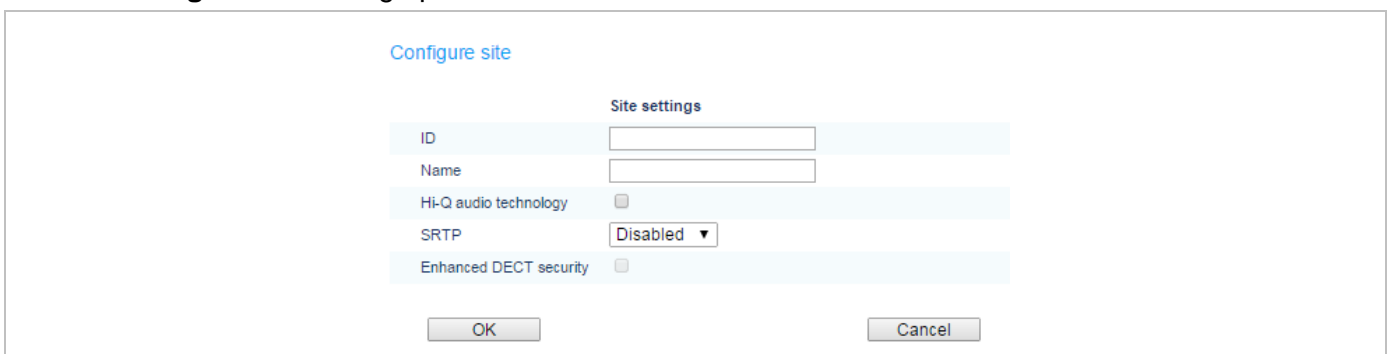

The screenshot shows the 'Configure site' dialog box with the following fields and options:

- ID:** Text input field.
- Name:** Text input field.
- Hi-Q audio technology:** Check box (unchecked).
- SRTP:** Dropdown menu (set to 'Disabled').
- Enhanced DECT security:** Check box (unchecked).

Buttons for 'OK' and 'Cancel' are at the bottom.

- ID:** Enter the identification number of the site. A value between 1 and 250 is possible. If no value is given, the OMM selects the next free ID.
- Name:** Enter the name of the site.
- Hi-Q audio technology, SRTP, Enhanced DECT security:** Enable or disable these capabilities.
  - In sites where these features are enabled, only RFP 35/36/37 IP and RFP 43 WLAN are supported.
  - In sites where these features are disabled, you can mix new RFP types with older RFP 32/34 and RFP 42 WLAN base stations.
- Press the **OK** button to save your changes.

## 5.5.2 EDITING A SITE

You can change the name of an existing site:

- 1 On the **Sites** page click on the  icon left behind the site entry.  
The **Configure site** dialog opens.
- 2 Change the site name.
- 3 Press the **OK** button.

## 5.5.3 DELETING A SITE

**Note:** Only sites without assigned base stations can be deleted. At least one site must remain, so the last site cannot be deleted.

To delete an existing site:

- 1 On the **Sites** web page click on the  icon left behind the site entry.  
The **Delete site** dialog opens.
- 2 Press the **Delete** button.

## 5.6 “BASE STATIONS” MENU

All configured base stations are listed on the **Base stations** page. The base stations are sorted by their Ethernet (MAC) addresses.



Base Stations

New

Sorted by: DECT clusters

Capturing unconfigured DECT base stations

Start

Capture allowed: ✗

12 Base Stations

DECT Cluster 1: 2 Base Stations										
ID	Name	MAC address	IP address	HW type	Site	RPN	Reflective environment	Connected	Active	
 	0000	SVE RFP1	00:30:42:18:1D:BD	10.37.18.31	RFP 35	3	00	✓	✓	✓
 	0001	SVE RFP2	00:30:42:18:20:A2	10.37.18.32	RFP 35	3	01	✓	✓	✓
DECT Cluster 5: 10 Base Stations										
ID	Name	MAC address	IP address	HW type	Site	RPN	Reflective environment	Connected	Active	
 	0002	simu	01:02:03:04:05:06	-	RFP 32	1	02	✗	✗	-
 	0003	simu	01:02:03:04:05:07	-	RFP 32	1	03	✗	✗	-
 	0004	simu	01:02:03:04:05:08	-	RFP 32	1	04	✗	✗	-
 	0005	simu	01:02:03:04:05:09	-	RFP 32	1	05	✗	✗	-
 	0006	simu	01:02:03:04:05:0A	-	RFP 32	1	06	✗	✗	-

You can select a sorting criterion for the RFP table. In the **Sorted by** field, select the criterion:

- **DECT clusters:** The base stations are sorted by clusters. All used clusters are displayed in the navigation bar on the left side. The OMM base station is marked with a bold font.
- **WLAN profiles:** The base stations are sorted by WLAN profile (see section 5.8).

- **Sites:** The base stations are sorted by sites (see section 5.5). All used sites are displayed in the navigation bar on the left side. The OMM base station is marked with a bold font.

The table provides information on all configured base stations and their status in several columns:

- **ID:** An internal number that is used to manage the base station.
- **Name:** Indicates the base station's name (see section 5.6.3).
- **MAC address:** Indicates the base station's MAC address (see section 5.6.3).
- **IP address:** Shows the current IP address of the RFP. The IP address may change over time by using dynamic IP assignment on the DHCP server.
- **HW type:** When the base stations connect to the OMM, they submit their hardware type. The hardware type is displayed in this column. If an error message is indicated in this column, there is a mismatch between the base station and the OMM software version (see section 5.6.2).
- **Site:** Indicates the site the base station is assigned to (see section 5.5).
- **RPN:** Shows the Radio Fixed Part Number that is currently used by the RFP.
- **Reflective environment:** Indicates if the base station is operated in a reflective environment (see section 5.6.3).
- **Connected:** Indicates if the base station is connected to the OMM (see section 5.6.1).
- **Active:** Indicates if the base station is active (see section 5.6.1).





The following tasks can be performed on the **Base stations** page:

- create and change base stations (see section 5.6.3),
- capture base stations (see section 5.6.4),
- delete base stations (see section 5.6.5).

### 5.6.1 BASE STATION STATES

For each base station the state of the DECT subsystem is displayed. These states are:

#### Synchronous

ID	Name	MAC address	IP address	HW type	Site	RPN	Reflective environment	Connected	Active
 	0000 License RFP 3	00:30:42:0D:DF:33	192.168.112.53	RFP L32	1	01			





The RFP is up and running. The RFP recognizes and is recognized by other RFPs in its cluster through its air interface and delivers a synchronous clock signal to the DECT phones.

#### Asynchronous

ID	Name	MAC address	IP address	HW type	Site	RPN	Reflective environment	Connected	Active
 	0000 License RFP 3	00:30:42:0D:DF:33	192.168.112.53	RFP L32	1	01			



The RFP has not been able to synchronize to its neighbors yet. No DECT communication is possible. But nevertheless the RFP has already been able to connect to the OMM. This phase should usually last only for a few seconds after starting up the RFP or the OMM. If this state lasts longer this is an indication for a hardware or network failure.

### Searching

ID	Name	MAC address	IP address	HW type	Site	RPN	Reflective environment	Connected	Active
 	0000 License RFP 3	00:30:42:0D:DF:33	192.168.112.53	RFP L32	1	01			

The RFP has lost synchronization to its neighbors. No DECT communication is possible. This phase should usually last only for a few seconds after starting up the RFP or the OMM. If this state lasts longer or is re-entered after being in a synchronous state this is an indication for a bad location of the RFP.

### Inactive

ID	Name	MAC address	IP address	HW type	Site	RPN	Reflective environment	Connected	Active
 	0000 License RFP 3	00:30:42:0D:DF:33	192.168.112.53	RFP L32	1	-	-		-





The RFP has connected to the OMM but the air interface has not been switched on yet. For any RFP with activated DECT functionality this phase should last only for a few seconds after starting up the RFP. If this state lasts longer this may indicate a hardware failure.

### Not connected

ID	Name	MAC address	IP address	HW type	Site	RPN	Reflective environment	Connected	Active
 	0000 License RFP 3	00:30:42:0D:DF:33	-	RFP L32	1	-	-		-

The RFP was configured but has not connected to the OMM yet. Therefore the IP address column is empty.

### Software Update available

ID	Name	MAC address	IP address	HW type	Site	RPN	Reflective environment	Connected	Active
 	0000 License RFP 3	00:30:42:0D:DF:33	192.168.112.53	RFP L32	1	01			

The RFP is connected to the OMM. The OMM has found new software on the TFTP server. The RFP is waiting for the OMM to initiate a reboot. In the meantime is the RFP fully operational.

## 5.6.2 OMM / RFP SOFTWARE VERSION CHECK

When the DECT base stations connect to the OMM, they submit their software version. If this version differs from the OMM software version and the versions are incompatible, the RFP connection attempt is rejected. This could happen when using several TFTP servers with different OpenMobility software versions. In this case, the RFP is marked with an error message. Moreover a global error message is displayed on the RFP list web page if at least one version mismatch has been found.

## 5.6.3 CREATING AND CHANGING BASE STATIONS

- 1 To configure a new RFP, click the **New** button on the **Base Stations** page.  
To change the configuration of an existing RFP click on the  icon left beside the base station entry.  
The **New base station** (or the **Configure base station**) dialog opens.

- 2 Configure the base station (see parameter descriptions below).
- 3 Click **OK**.

**Please note:** DECT regulatory domain, WLAN regulatory domain and WLAN profile must be configured first. Otherwise DECT and/or WLAN cannot be enabled.

The following parameters can be set in the **New base station** and the **Configure base station** dialogs:

**General settings**

- **MAC address:** Each RFP is identified by its unique MAC address (6 bytes hex format, colon separated). Enter the MAC address (as it appears on the back of the base station chassis).
- **Name:** For easier administration each RFP can be associated with a location string. The location string can hold up to 20 characters.
- **Site:** If several sites exist (see section 5.5), select the site the RFP is assigned to.

**DECT settings**

The DECT functionality for each RFP can be switched on/off.

- **DECT cluster:** If DECT is active the RFP can be assigned to a cluster.
- **Preferred synchronization source:** Activate this checkbox if the RFP should be used as synchronization source for the other RFPs in the cluster. For background information on RFP synchronization see section 7.2.
- **Reflective environment:** Within areas containing lot of reflective surfaces (e.g. metal or metal coated glass) in an open space environment the voice quality of a DECT call can be disturbed because of signal reflections which arrive on the DECT phone or RFP using multipath propagation. Calls may have permanent drop outs while moving and high error rates on the RFPs and DECT phones.

For such environment Mitel has developed the DECT XQ enhancement into the RFP base stations and the Mitel 600 DECT phones family. Using this enhancement by switching the **Reflective environment** flag on might reduce drop outs and cracking noise.

As soon as **Reflective environment** is switched on, the number of calls on an RFP is reduced to 4 calls at the same time.

**Please note:** The RFPs and DECT phones use more bandwidth on the Air Interfaces if the “Reflective environment” attribute is switched on. Therefore this is used when problems caused by metal reflections are detected.

### WLAN settings

The WLAN section applies to RFPs of the type “RFP 42 WLAN” and “RFP 43 WLAN” only. For details about WLAN configurations please see section 7.18.

RFP 42 WLAN and RFP 43 WLAN have different WLAN parameters, which are configurable in the RFP configuration dialog.

- Activation check box: Enables or disables the WLAN function for this RFP.
- **WLAN profile:** Select the desired profile from the list. This applies all settings made in the respective WLAN profile to the current RFP. For information on configuring WLAN profiles see section 5.8.1.

**Please note:** WLAN settings are only configurable if the RFP has been connected at least once to detect the hardware type and a proper WLAN profile is configured (see also section 5.8.1). WLAN cannot be enabled in the **New DECT base station** dialog if the hardware type is unknown.

The following settings are not applied by the WLAN profile. Configure these settings for each RFP individually.

- **Antenna diversity** (RFP 42 WLAN only): This option should generally be activated so that the AP (Access Point) can automatically select the antenna with the best transmission and reception characteristics.
- **Antenna** (RFP 42 WLAN only): If **Antenna diversity** is switched off, this setting determines the antenna that is used for transmitting or receiving WLAN data.
- **802.11 channel:** Determines the WLAN channel used by the current RFP. The channel numbers available are determined by the WLAN **Regulatory domain** setting on the **System settings** page.
- **Output power level** (default: “Full”): Determines the signal power level used by the RFP to send WLAN data. You may limit the power level to minimize interferences with other WLAN devices. The actual power level is also capped by the WLAN **Regulatory domain** setting on the **System settings** page.
- **HT40** (RFP 43 WLAN only): High throughput mode with 40 MHz bandwidth increases data rate up to 300 MBit/s.

## 5.6.4 CAPTURING DECT BASE STATIONS

Base stations that are assigned to the OMM by DHCP options or OM Configurator settings may connect to the system.

- 1 On the **Base Stations** page, press the **Start** button below the “Capturing unconfigured DECT base stations” caption.

The page is updated with the MAC addresses of those base stations that attempted to register with the OMM (unregistered RFPs).

**Note:** These entries are not actually stored, and are lost after an OMM reset.

- 2 By clicking on the edit icon  of the appropriate base station, you can add further data and store the base station (see section 5.6.3).

## 5.6.5 DELETING DECT BASE STATIONS

To delete an existing DECT base station:

- 1 On the **Base Stations** page, click on the  icon left beside the RFP entry.  
The **Delete base station?** dialog opens showing the current configuration of this RFP.
- 2 Click the **Delete** button.

**Please note:** The RFPs bound to a license (License RFPs) cannot be deleted. The License RFPs are displayed in the list with a license icon  instead of the trash icon. For further information on licenses see section 3.32).

## 5.7 “DECT PHONES” MENU

The **DECT Phones** page provides an overview of all configured DECT phones sorted by their number. To keep the list concise, the complete list is split up into sub lists containing up to 100 DECT phones. You can move back and forth in increments of 100 DECT phones.



**DECT Phones**

New Import Search

PARK: 31100462074346  
 Subscription allowed: ✗  
 Auto-create on subscription: ✓

Subscription with configured IPEIs  
 Start

Wildcard subscription  
 2 min Start

1 - 84 (84) DECT Phones

Display name	Number/SIP user name	IPEI	Subscribed	Download
x25052 612d	25052	10345 0031639 *	✓	✓
x25053 622d	25053	03586 0952116 0	✓	✓
x25054 622d	25054	03586 0950946 7	✓	✓
x42052 622d	42052	03586 0952129 3	✓	✓
simu pp 0	256001	00100 0000000 3	✗	-
simu pp 1	256002	00100 0000001 4	✗	-
simu pp 2	256003	00100 0000002 5	✗	-
simu pp 3	256004	00100 0000003 6	✗	-

The table provides information on the DECT phones and their status in several columns:

- **Display name:** Indicates the DECT phone name.
- **Number/SIP user name:** Indicates the internal call number of the DECT phone.
- **IPEI:** Indicates the DECT phone IPEI.
- **Subscribed:** Indicates if the DECT phone is subscribed to the system.
- **Download:** This column is only displayed if the “Download over Air” feature is started successfully and provides information about the download status of the DECT phone software (see section 7.20).

**Note:** All DECT phone data that are configured as unbound (split into DECT phone and user data) are also listed at the OM Web service when a user is logged in at the DECT phone, but they cannot be deleted or changed. This is indicated by the and icons. Unbound DECT phones where no user is logged in are not displayed on the **DECT phones** page.

The following tasks can be performed on the **DECT Phones** page:

- create and change DECT phones (see section 5.7.1)
- import DECT phone configuration files (see section 5.7.2),
- subscribe DECT phones (see section 5.7.3)
- delete DECT phones (see section 5.7.4)
- search within the DECT phone list (see section 5.7.5)

### 5.7.1 CREATING AND CHANGING DECT PHONES

- 1 To configure a new DECT phone, click the **New** button on the **DECT phones** page. To change the configuration of an existing DECT phone click on the icon left beside the DECT phones entry.

The **New DECT phone** or the **Configure DECT phone** dialog opens.

2 Configure the DECT phone (see parameter descriptions below).

3 Press the **OK** button.

The following parameters can be set in the **New DECT phone** and the **Configure DECT phone** dialog:

### General settings

- **Display name:** The name parameter represents the SIP Display Name field. This parameter is optional but recommended.
- **Number/SIP user name:** The number is the SIP account number or extension for the DECT phone.
- **IPEI:** This optional setting is the DECT phone IPEI number. On a Mitel DECT 142 / Mitel 142d DECT phone, the IPEI can be found via the following path of the DECT phone menu: **Main menu > Phone settings > System**. On a Mitel 600 DECT phone, the IPEI can be found in the **System** DECT phone menu. Consult the DECT phone's user guide for further information.
- **DECT authentication code:** The DECT authentication code is used during initial DECT subscription as a security option and can be set here for each DECT phone separately (DECT phone-specific DECT authentication code). This parameter is optional. If no DECT phone-specific DECT authentication code is set, the system-wide DECT authentication code is used.
- **Login/Additional ID:** The additional ID can be used as a mean for data search within wildcard subscription (because of the IPEI is not configured which selects the data otherwise).
- **Delete subscription:** This option is only available when configuring an existing DECT phone (in the **Configure DECT phone** dialog). If this option is selected, the DECT phone will be unsubscribed.
- **SOS number, ManDown number:** SOS and ManDown are calling numbers which will be automatically called as soon as an SOS or ManDown event happens. If no individual SOS or ManDown number is configured for a DECT phone, the number of the appropriate alarm trigger will be used as a system-wide calling number in case of a SOS or ManDown event. Please see /31/ for details.

- **Voice mail number:** The voice mail number is the number which will be automatically called as soon as a voice mail call is initiated on the Mitel 600 DECT phone. If there is no individual voice mail number configured in this field, then the system-wide voice mail number is used (see also the **System setting** menu, section 5.4.1.7). If there is no voice mail number configured (neither the individual nor the system-wide) or another DECT phone type is used, then the voice mail number must be configured locally in the DECT phone.
- **Number used for visibility checks:** Provides phone number or SIP user name used for standby OMM visibility checks.

### SIP authentication

- **User name:** The SIP Authentication user name is optional but recommended. It represents the name which will be used during SIP registration and authentication. If no name is given the number will be used by default.
- **Password, Password confirmation:** The password will be used during SIP registration and authentication. Enter the appropriate data in these fields.

## 5.7.2 IMPORTING DECT PHONE CONFIGURATION FILES

A set of DECT phones can also be configured in a semi-automatic manner by import of a configuration file.

1 On the **DECT Phones** page press the **Import** button.

The **DECT phone enrolment** page opens.

2 Select your configuration file and press the **Import** button. For information on the file layout see section 10.1.1.

3 A parsing protocol can be read, if you press the referring **Log file** button. All successfully imported data records are presented in a list:

4 Select the DECT phones you want to add to the OMM database by selecting the appropriate checkboxes, and click **Add**.

All successfully stored records are marked green in the **Added** column.

Failed records are marked with a red star.

5 To read error hints in the referring log file, press the **Log file** button. Error hints can also be read in a syslog trace.

6 To remove imported data entries, activate the check box next to the desired entries. Press **Delete** to remove the selected entries.

### 5.7.3 SUBSCRIBING DECT PHONES

#### Preparation by OMM Web service

After adding a DECT phone configuration to the OMM, the DECT phone must be subscribed. The OMM must first be enabled to allow subscriptions from DECT phones. This is done by pressing the following buttons on the **DECT Phones** page.

- **Start** button under the “Subscription with configured IPEI” caption (see section 5.7.3.1). This button enables subscription for the next 24 hours.
- **Start** button and time interval parameter under the “Wildcard subscription” caption. This button enables wildcard subscription for the selected time. After expiry the “subscription with configured IPEIs” is still enabled for 24 hours.

**Note:** To ease the first installation of a DECT system, the subscription is enabled permanently while at least one DECT phone (with IPEI) is set up in the database and no DECT phone is subscribed. After successful subscription of the first DECT phone the subscription will still be enabled for 24 hours.

#### Subscription steps, done by DECT phone

After the DECT phone configuration is complete on the OMM and the OMM is allowing new subscriptions, each DECT phone must subscribe to the system.

On each DECT phone, the administrator or user must subscribe to the SIP-DECT system through the **System -> Subscriptions** menu. The specific PARK code for the SIP-DECT system should be entered to subscribe to the system.

**Please note:** The PARK is displayed in the top-right corner of the **DECT Phones** page. Each SIP-DECT deployment has a unique PARK code.

If the administrator configured a global or device-specific DECT authentication code, the administrator/user must enter in the code before the DECT phone subscribes to the system.

For “wildcard subscription”, an additional ID may be configured (see sub section Wildcard Subscription).

#### 5.7.3.1 Subscription with Configured IPEI

The DECT phone data to be assigned to the subscribing DECT phone are identified by the IPEI. The identity of a DECT phone (IPEI) is already known by the system before the DECT phone attempts to subscribe. Unknown DECT phones are not allowed to subscribe in this mode.

To enable subscriptions, click the **Start** button under the section **Subscription with configured IPEIs** caption on the **DECT Phones** page.

The OMM allows a subscription of configured but not subscribed DECT phones during the next 24 hours. The administrator must press the Subscribe button again to permit more DECT phones to subscribe to the SIP-DECT system.

**Note:** Older DECT phones may not offer the possibility to enter an access code (AC). You should always subscribe these DECT phones with configured IPEI to maintain security.

### 5.7.3.2 Wildcard Subscription

To minimize administration effort, subscription is also possible, if the IPEI is not configured. But because of the loss of further security by IPEI check, this kind of subscription is only allowed within a short default time interval of 2 minutes.

To enable subscriptions, press the **Start** button of the section **Wildcard subscription** on the **DECT phones** page. If necessary, increase the time interval (or refresh subscription permission in time).

The OMM will allow a wildcard subscription during the set time interval. In case of timeout the permission is lost. Only subscription with IPEI remains allowed within the fixed limit of 24 hours.

To achieve a selection of data during subscription (e.g. the user name being assigned to the DECT phone), the field “additional ID” can be set in OMM data. If the OMM receives a valid “additional ID” during subscription, the referring data are assigned to the DECT phone.

If the additional ID is requested for a data record, the DECT phone user must type it. “Additional ID” can be set within the authentication code menu. Please type the R-Key and type the additional ID.

**Please note:** The input of the additional ID is only possible with Mitel 142 and Mitel 600 DECT phones. The value is not supported on third party GAP phones. If GAP phones are going to subscribe wildcard, the first free DECT phone data record without any additional ID will be assigned.

### 5.7.4 DELETING DECT PHONES

To delete an existing DECT phone:

- 1 On the **DECT phone** page click on the  icon left beside the DECT phone entry.  
The **Delete DECT phone?** dialog opens showing the current configuration of this DECT phone.
- 2 Press the **Delete** button.

### 5.7.5 SEARCHING THE DECT PHONE LIST

You can use the search function to search for a specific DECT phone in the DECT phone list. The search function allows you to find a DECT phone by a given number or IPEI.

- 1 On the **DECT phones** page click on the **Search** button.  
The **Search DECT phone** dialog opens.

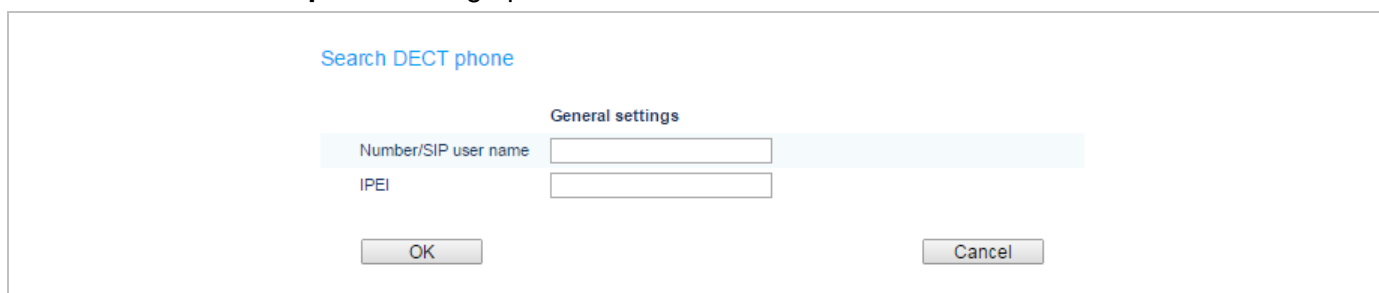

The screenshot shows a dialog box titled "Search DECT phone" with a sub-header "General settings". It features two input fields: "Number/SIP user name" and "IPEI". At the bottom of the dialog, there are two buttons: "OK" and "Cancel".

- 2 Enter the DECT phone’s number or IPEI. At least one parameter must be set. The entered number or IPEI must match exactly with a DECT phone’s number or IPEI. If number **and** IPEI are given then a

DECT phone must exist in the OMM's database whose number and IPEI match both otherwise the search fails.

If a DECT phone with the specified number and/or IPEI was found, a list is displayed with this DECT phone as the first entry. The search function can also be used to get to the right sub list in one step.

### 5.7.6 DISPLAYING USER AND DECT PHONE DATA

You can display a summary of user status and DECT phone configuration in a pop-up window on the **DECT Phone** page. Click the magnifying glass icon beside a DECT phone entry to view the **User/device status & configuration** window.

**Note:** A configuration and status summary for the DECT phone is also available on the DECT phone under the Administration menu. The presentation layout is similar to the OMM Web service window, but the DECT phone only displays its own data.

User/device status & configuration

**User status:**

Registered:	Yes
Registrar server type:	Primary
Registrar server:	10.37.44.99
Registrar port:	5060
Calculated local port:	5060
Silent charging:	No
CoA data loaded:	No

**User configuration data:**

User ID:	1
User rel. type:	Fixed
Name:	x25052 612d
Number:	25052
Description 1:	
Description 2:	
User lang.:	English
SOS number:	
MD number:	
VM number:	
SIP auth. user name:	25052
SIP auth. password:	*****
Fixed local port:	
Login/Add ID:	
PIN:	*****
External:	No

The following table summarizes the parameters displayed in the **User/device status & configuration** window.

Parameter	Description
<b>User status</b>	
Registered	Current SIP user registration status Yes = registered No = not registered
Registrar server type	Current SIP registrar: Primary or backup SIP registrar (secondary or tertiary)
Registrar server	IP address of the SIP Registrar
Registrar port	Port number of the SIP Registrar
Calculated local port	SIP user's automatically determined client port
Silent charging	Current silent charging state Yes = in silent charging mode No = not in silent charging mode
CoA data loaded	COA data sent to DECT phone Yes = data has been sent No = no data sent
<b>User configuration data</b>	
User Id	Internal system identifier for the user
User rel. Type	Type of association between the user and DECT phone. Dynamic or fixed.
Name	User's name
Number	SIP user name or number
Description 1	Additional textual description for a user (e.g., department or function)
Description 2	Additional textual description for a user (e.g., department or function)
User lang.	Language setting on the DECT phone
SOS number	Emergency number to be dialed when the SOS key has been pressed
MD number	Emergency number to be dialed when a sensor alarm (Mitel 600 DECT phone) has been initiated
VM number	Voice mail number (dialed by a long press of '1' key on the Mitel 600 DECT phone)
SIP auth. user name	SIP authentication user name
SIP auth. password	SIP authentication password
Fixed local port	SIP user's configured fixed client port (used for SIP registration)
Login/Add ID	ID used for user identification during login procedure at the DECT phone OR ID used for wildcard subscription during DECT phone subscription procedure
PIN	PIN used for user identification during login procedure at the DECT phone "*****" = a PIN is set, empty = no PIN is set
External	User data provided by an external provisioning server (<user>.cfg) Yes = user data imported from a server No = user data only stored internally in the OMM DB

VIP	To guarantee a minimum blackout for a very important person (e.g. emergency user) the SIP (re-)registration of such people can be prioritized. Yes = prioritized No = not prioritized
Visibility checks	The OMM standby feature uses an existing SIP account to check the availability of the registrar. Yes = this account is used No = this account is not used
Sending messages	User's permissions to send text messages using the Mitel 600 DECT phone Yes = user is authorized to send text messages No = user is not authorized to send text messages
Sending vCards	User's permissions to send vCards using the Mitel 600 DECT phone Yes = user is authorized to send vCards No = user is not authorized to vCards
Receiving vCards	Indicates whether the user accepts received vCards Yes = incoming vCards are accepted No = incoming vCards are not accepted
Video stream perm.	User's permissions to access video using the Mitel 602 DECT phone Yes = user is authorized to access video No = user is not authorized to access video
Locate	User's permissions to locate other users using the Mitel 600 DECT phone Yes = user can locate other users No = user cannot locate other users
Tracking	Tracking forces the Mitel 600 DECT phone to indicate every change of the DECT base station even in idle state Yes = tracking is active No = tracking is inactive
DECT locatable	Permission to locate the user (i.e., through the SIP-DECT locating solution) Yes = locating the user is permitted No = not permitted
Keep personal dir.	The local directory of the Mitel 600 DECT phone is usually the user's personal directory and is cleared at logout. If deleting the directory content is not desirable, this option can be set Yes = local directory is not cleared No = local directory is cleared
Logout on charging	A user logout can be performed automatically when the Mitel 600 DECT phone is placed in the charger cradle Yes = automatic logout when put in charger No = no automatic logout
Forward mode	Mode of Call diversion or Call forwarding (Off, Immediately, Busy, No answer, Busy & no answer)
Forward time	Time delay in seconds before the incoming call is redirected.
Forward dest.	Destination of the redirected call
Hold ring back time	Time in minutes after which the user wants to be reminded of the connection on hold 0 = Off, no reminder



Call waiting disabled	An incoming call is signaled in-band if the user is otherwise engaged (Call waiting). This feature can be disabled Yes = call waiting is disabled No = call waiting feature is active
Auto answer	Enables or disables auto-answer on incoming calls. If auto answer is enabled, the DECT phone plays a tone to alert the user before answering the call. If auto answer is disabled, the DECT phone treats the incoming call as a normal call.
Microphone mute	Enables or disables microphone muting when incoming calls are automatically answered.
Warning tone	Enables or disables a warning tone to play when the DECT phone receives an incoming call on an active line. A short ringtone is played if there are no active calls. If there is an active call in a "barge in" situation, the ringing will be in-band.
Allow barge in	Allows/disallows how the DECT phone handles incoming calls while the DECT phone is on an active call. When enabled an incoming call takes precedence over an active call, by placing the active call on hold and automatically answering the call. When disabled the DECT phone treats an incoming call like a normal call.
Monitoring mode	SIP-DECT supports a "User Monitoring" feature to check the availability of a user to receive calls or messages. On = monitoring feature is active Off = monitoring feature is not activated
Conference server type	User-specific setting of the conference service to be used for three-way conferencing None = three-way conferencing is disabled Global = OMM system setting is used (default) Integrated = integrated conference server is used
Conference server URI	URI for the external conference server
Use CoA profile	ID of the CoA (Central DECT phone configuration over air) profile
<b>Device status</b>	
IPEI	International Portable Equipment Identifier (globally unique identifier of the DECT phone)
HW type	Hardware type of 600 DECT phone or 142d otherwise "unknown"
SW version	Version of the software on the Mitel 600 DECT phone
Subscribed	Subscription status of the DECT phone Yes = DECT phone is subscribed No = DECT phone is not subscribed
Encryption	DECT encryption status Yes = Encryption is enabled No = Encryption is disabled
Capability "Messaging"	Messaging capability of the DECT phone Yes = DECT phone supports messaging No = DECT phone does not support messaging
Capability "Enh. Locating"	Enhanced locating capability of the DECT phone Yes = DECT phone supports enhanced locating No = DECT phone does not support enhanced locating

Capability "Video"	Video capability of the DECT phone Yes = DECT phone supports video No = DECT phone does not support video
Capability "CoA profile"	CoA capability (Central DECT phone configuration over air) of the DECT phone Yes = DECT phone supports CoA No = DECT phone does not support CoA
Device auto-created	Auto-creation occurs when the DECT phone data set is automatically generated in the OMM's database at subscription time. No administrative task is required on the SIP-DECT system to subscribe a DECT phone in this auto-create mode. Yes = DECT phone has been subscribed in auto-create mode No = DECT phone has not been subscribed in auto-create mode
Default CoA profile loaded	A default CoA profile (Central DECT phone configuration over air) can be sent to a 600 DECT phone Yes = a default profile was sent No = no default profile was sent
<b>Device configuration data</b>	
Device ID	Internal system identifier for the DECT phone

## 5.8 "WLAN" MENU

The **WLAN** menu allows you to manage the wireless LAN function of all WLAN capable RFPs that are connected to the OMM. You can view and change wireless parameters and security settings to adapt the WLAN configuration to suit your needs. You can also check how many and which wireless clients are currently connected. Nevertheless, the WLAN function is only available for base stations of the type RFP 42 WLAN and RFP 43 WLAN.

**Note:** You cannot activate the WLAN function for the OMM, even if the OMM base station is an RFP 42 WLAN.

For a detailed description on WLAN configuration see the section 7.18.

### 5.8.1 "WLAN PROFILES" MENU

WLAN settings are grouped in WLAN profiles. You need at least one WLAN profile that can be assigned to one or more WLAN-RFPs. You can define more than one WLAN profile, to a maximum of 20 WLAN profiles. You can manage / change the desired WLAN settings for a group of WLAN-RFPs by changing their assigned WLAN profiles. Moreover, you can manage different settings, for example separate WLAN profiles for different buildings, a special WLAN profile for temporary use, or WLAN profile for RFPs only useable by guests.

Note the different WLAN profile types:

RFP type	WLAN profile type
RFP 42 WLAN	RFP42
RFP 43 WLAN	RFP43

The **WLAN profiles** menu allows configuration and administration of these WLAN profiles. The following tasks can be performed:

- create and change WLAN profiles (see section 5.8.1.1)
- delete WLAN profiles (see section 5.8.1.2)
- export WLAN profiles (see section 5.8.1.3)

The defined WLAN profiles are then assigned to one or more WLAN base stations (see section 5.8.2). Note, that some device-specific WLAN settings are not part of a WLAN profile, such as the channel and the antenna configuration. These settings are defined separately for each base station (see section 5.6.3).

### 5.8.1.1 Creating and Changing WLAN Profiles

You need at least one active WLAN profile in order to operate the WLAN function for an RFP 42 WLAN or RFP 43 WLAN device.

- 1 Navigate to the **WLAN profiles** page. This page shows the number of existing WLAN profiles and a list of available WLAN profiles.
- 2 If you create a new WLAN profile, configure the RFP type first to get the correct input fields. Select the appropriate profile (**RFP42** or **RFP43**) from the **WLAN profile type** selection list.
- 3 To add a new WLAN profile, press the **New** button. To change an existing WLAN profile, click on the  icon available on the left of the WLAN profile entry.

The **New WLAN profile** page resp. the **WLAN profile [Number]** page shows the WLAN profile configuration.

- 4 Change the desired settings of the WLAN profile. You need at last to define the ESSID setting. The different settings are explained in detail in the sections below.

- 5 Activate the **Profile active** setting; otherwise the WLAN profile is inactive which de-activates the WLAN function for base stations that are assigned to this WLAN profile.
- 6 Press the **OK** button to apply the settings. If you created a new WLAN profile, you can proceed by assigning the WLAN profile to the desired base stations (see section 5.6.3). If you changed an existing WLAN profile, the settings are applied to the assigned base stations automatically.

The following description details the different parameters that are available on the **New WLAN profile** page and. on the **WLAN profile [Number]** page.

### General settings

- **Profile active:** Activate this checkbox to activate the profile. This in turn activates the WLAN function for all RFPs that are assigned to the WLAN profile.
- **SSID:** Enter a descriptive character string to identify the WLAN network (e.g. "OurCompany"). The service set identifier is broadcasted by the RFP within "WLAN beacons" in a regularly interval. The SSID identifies the WLAN network and is visible by all WLAN clients. This is typically used with a scan function, e.g. from a WLAN client that tries to establish a connection. The SSID should not exceed 32 characters and it is advisable not to use unusual characters that may trigger WLAN client software bugs.
- **VLAN tag** (number, 1..4094, default: off): You can separate VoIP and client data traffic (transferred via WLAN) by using different virtual LANs, e.g. to prevent bulk data transfers to interfere with VoIP. To use a separate VLAN for the client data traffic, activate the check box and enter the desired VLAN number (see sections 7.18 and 7.12).
- **Beacon period** (milliseconds, 50..65535, default: 100 ms): Determines the WLAN beacon interval. A higher value can save some WLAN airtime that can be used for data transfers.
- **DTIM period** (number, 1..255, default: 5): Determines the number of beacons between DTIM messages. These messages manage the WLAN wakeup/sleep function e.g. that is critical for battery powered WLAN clients.
- **RTS threshold** (bytes, 0..4096, default: 2346): If a WLAN packet exceeds this threshold, it will be transferred with RTS/CTS handshake. This may improve transfer reliability if several WLANs share the same channel. The default of 2346 byte switches off this function because the IP-MTU is typically only 1500 byte.
- **Fragmentation threshold** (bytes, 0..4096, default: 2346): If a WLAN packet exceeds this threshold, it will be transferred in chunks. This may improve transfer reliability for a weak connection. The default of 2346 bytes switches off this function because the IP-MTU is typically only 1500 byte.
- **Maximum rate** (list of rates in Mbps, 1..54, default: 54): This setting applies to RFP 42 WLAN only. Determines the maximum transfer rate used by the RFP. You can limit the rate to increase the WLAN range, e.g. to prevent WLAN clients in the vicinity of the RFP to disturb distant WLAN clients.
- **802.11 mode** (RFP 42 WLAN selection list: Mixed / 802.11b only / 802.11g only, default: Mixed): Both the older and long-ranged B-Mode and the newer and faster G-Mode are typically supported by WLAN clients. You can change this setting to prevent problems with very old WLAN clients. (RFP 43 WLAN selection list: 802.11bg / 802.11b only / 802.11g only / 802.11abg / 802.11n, default: 802.11bg): On the **RFP43** profile you can choose additionally 802.11 modes 802.11abg and 802.11n.

Mode	802.11abg	802.11n
Open	yes	yes
WEP	yes	no
Radius (802.1x WEP)	yes	no
WPA v.1 (802.1x + PSK)	yes	no
WPA v.2 (802.1x + PSK)	yes	yes

- **Hidden SSID mode** (on / off, default: off): If switched on, the transmission of the SSID within beacons is suppressed. This in turn requires a more elaborate and manual connection procedure for WLAN clients.
- **Interference avoidance** (on / off, default: off): This setting applies to RFP 42 WLAN only. Enables a WLAN procedure to enhance radio interference avoidance.

### Security settings

These settings determine the encryption used for the WLAN connection. Select one of the four modes (Open, WEP, WPA, or Radius). This will activate / gray-out the necessary additional input fields that specify further security settings on the **WLAN profile** page.

- **Open system**: Enable this option to deactivate authentication and encryption (“Hotel mode”). Note, that all data is transferred un-encrypted in this mode, which can be easily eavesdropped with any WLAN equipment.
- **Wired equivalent privacy (WEP)**: Enable this option to use the older WEP encryption mode. This mode may be useful, e.g. if your WLAN should support older WLAN clients that do not implement the recommended WPA encryption.
  - **Privacy** (on / off, default: off): De-activate this setting to use no authentication (“Open System”) with standard WEP encryption. Activate this setting to use an additional shared key authentication between the RFP and the WLAN client.
  - **Number of tx keys** (number, 1..4, default: 1): The WEP encryption can use a single shared key or multiple shared keys (“key rotation”). Select the number of shared keys, select how to enter a shared key (by default as **Text** or as **Hex value**), and select the **Cipher length** (see **Key settings** below).
  - **Default tx key** (number, 1..4, default: 1): If more than one shared keys is used, you can select the default shared key. You must configure the same default key on the WLAN client.
  - **Key #1 – Key #4**: Enter one or more shared key. The **Cipher length** setting (see **Key settings** below) determines the length of the required input. If you selected to enter as **Text** (see above), input a password with 5, 13, or 29 characters that matches a 64 or 128 bit cipher. If you selected to enter as **Hex value**, you can input a hexadecimal number with 10, 26, or 58 characters (0-9, a-f). Press the **Generate** button to generate a random shared key that matches the current settings.
- **WiFi protected access (WPA)**: Enable this option to use the recommended WPA encryption mode.
  - **Type** (selection, WPA any / WPA v.1 / WPA v.2, default: WPA any): Select the WPA version required for WLAN clients. The **WPA any** setting allows WPA v.1 and WPA v.2 to be used concurrently. The **WPA v.1** setting enforces the use of the older RC4-based encryption. The **WPA v.2** setting enforces the use of the stronger AES encryption. You can also change the distribution interval (see **Key settings** below).

- **802.1x (Radius)**: Select this option if your WLAN should use a RADIUS server for WLAN client authentication (“Enterprise WPA” with different username/password combinations per client). You must also specify the **Radius settings** (see below). For details about the RADIUS authentication procedure, using the public keys, and importing certificates to the WLAN clients refer to the documentation of your RADIUS server product.
- **Pre-shared key**: Select this option to use a single shared key for all WLAN clients (**Value** setting below). A WLAN client user needs to enter the shared key in order to connect.
- **Value**: You can enter a shared key as **Text**. Use a longer text sequence with alphanumeric characters and special characters to enhance the shared key strength. A text shared key is case sensitive. Alternatively, the shared key can be entered as **Hex value** (hexadecimal number, 0-9, a-f). Press the **Generate** button to generate a random shared key that matches the current settings.
- **802.1x (Radius)**: This setting applies to RFP 42 WLAN only. Enable this option to use the RADIUS authentication without the stronger WPA encryption. You must also specify the **Radius settings** and you may adapt the **Key settings** (see below).
- **MAC access filters** (on / off, default: off): This setting applies to RFP 43 WLAN only. You can limit WLAN access for WLAN clients with specified MAC addresses. Note, that without encryption this should not be used for security reasons. You can configure a list of MAC addresses that are allowed to connect via the **MAC access filters** tab on the WLAN profile page.
- **BSS isolation** (on / off, default: off): In a standard WLAN setup, each WLAN client can contact other WLAN clients. For special purposes (e.g. “Internet café setup”), you may switch on this options to protect WLAN clients from eavesdropping on other WLAN clients.

### Key settings

- **Cipher length** (selection, 64 Bits / 128 Bits / 256 Bits (RFP 42 WLAN only), default: 64 Bits): Determines the key length used for the WEP encryption. Larger bit sequences provide better security but may be unsupported by very old WLAN clients.
- **Distribution interval** (seconds, 1..65535, default: 20): Determines how often the WEP encryption is re-negotiated.

### Radius settings

The parameters in this section can only be configured if the **802.1x (Radius)** option has been selected.

- **IP address**: Enter the IP address of the RADIUS server.
- **Port**: Enter the port number used to connect to the RADIUS server. Press the **Default** button to change to the standard port.
- **Secret**: Enter the character string that is used by the RFP to secure the communication with the RADIUS server.

### QoS settings

- **WME**: (on / off, VLAN or DiffServ (RFP 42 WLAN only), default RFP 42 WLAN: off/VLAN, default RFP 43 WLAN: off): You can enable the Wireless Media Extensions to prioritize WLAN traffic. The WLAN traffic priority is determined by **VLAN** number or by examining the **DiffServ** data field of IP packets.

### SSID2 – SSID4 Tabs

You can enable up to three additional virtual WLAN networks that are managed by their SSID. This can be used for example to provide WLAN access for guests that is separated from the company WLAN by means of VLAN tags and encryption settings. To activate this feature proceed as follows:

- 1 Switch to the appropriate **SSID** tab, e.g. SSID2. Activate the **Active** check box to enable the additional virtual WLAN. The tab provides separate configuration items for the selected SSID.
- 2 Enter at least a new **SSID**. Also enter a currently unused **VLAN tag** number.
- 3 You can specify different authentication/encryption settings for each SSID section. For example, you can use **WPA / Pre-shared key** with different passwords.

Note that some configuration combinations are incompatible with multiple SSIDs. For example, the wireless hardware only manages a single WEP encryption key. Also, some features apply to all defined SSIDs, including the **MAC access filters** list.

You can edit the **MAC access filters** list via the **MAC access filters** tab on the WLAN profile page.

- You can import a prepared list of MAC addresses (\*.txt. file, one line per MAC address) Use the **Browse** button to select the file from the file system. Afterwards press the **Import** button.
- To configure single MAC addresses, use the **New** button in the **General settings** section. Enter the address in the following **New MAC access filter** dialog.
- To delete a single MAC address, click on the  icon left behind the address entry. Use the **Delete all** button to delete the entire list.
- Using the **Save** button you can export the MAC address filter list.

The **Associate** column indicates for each MAC address if the respective WLAN client is currently connected to the WLAN.

### 5.8.1.2 Deleting WLAN Profiles

To delete an existing WLAN profile:

- 1 You cannot remove WLAN profile that is in use. To remove a currently used WLAN profile, you must select another WLAN profile for all assigned RFPs first (see section 5.6.3).
- 2 On the **WLAN profiles** page click on the  icon next to the profile entry.  
The **Delete WLAN profile?** dialog opens showing a summary of the WLAN profile's configuration.
- 3 Press the **Delete** button.

### 5.8.1.3 Exporting WLAN Profiles

To simplify the configuration of wireless devices, you can export SSID configuration to a XML WLAN profile file. To export the configuration, click on the  icon.

On Windows 7 you can use the "netsh wlan add profile filename=xxx" command to import a WLAN configuration. Many other tools to import WLAN configuration files are available for Windows Vista / Windows XP systems (for example wlan.exe from Microsoft).

## 5.8.2 "WLAN CLIENTS" MENU

The **WLAN clients** page shows the status of all WLAN clients currently connected to the WLAN. This can be used for example for troubleshooting purposes. The display shows the total number of connected WLAN clients and a list of RFPs that are part of the WLAN. For each RFP, the WLAN client connected to the RFP are listed. You can view the **MAC address** and the current **Status** of each WLAN client.

## 5.9 “SYSTEM FEATURES” MENU

The **System features** menu allows administration of system features concerning call number handling and directory access.

### 5.9.1 “DIGIT TREATMENT” MENU

A number manipulation is provided by the digit treatment feature for corporate directories that handles both incoming and outgoing calls.

#### Digit treatment for LDAP directories

A chosen number from an LDAP directory entry is checked against the external prefix pattern and if a pattern matches, it is replaced by the configured internal prefix pattern. Only the best matching rule will be applied.

Before a rule is applied, the following characters are automatically removed from the LDAP directory entry: ‘%’, space, ‘(’ and ‘)’. The result of the conversion is sent to the DECT phone to be displayed e.g. in the directory entry details and entered in the redial list.

**Note:** A conversion performed for an LDAP directory entry can be reversed if the rule is also activated for an outgoing call.

#### Incoming call

The calling party number of an incoming call is checked against the configured external prefix pattern and if a pattern matches it will be replaced by the internal prefix pattern. Only the best matching rule will be applied.

The result of the conversion is sent to the DECT phone to be displayed and entered in the call log<sup>1</sup>.

#### Outgoing call

The dialed number of an outgoing call is checked against the configured internal prefix pattern and if a pattern matches it will be replaced by the external prefix pattern. This applies to en-bloc dialed numbers and to overlap sending as long as the SIP session has not been initiated.

**Note:** To support digit treatment and overlap sending, it is necessary to have a dial terminator configured.

The result of the conversion is not sent to the DECT phone to be displayed or entered in the call log<sup>2</sup>.

The following tasks can be performed on the **Digit treatment** page:

- creating and changing “Digit treatment” entries (see section 5.9.1.1)
- deleting “Digit treatment” entries(see section 5.9.1.2)

#### 5.9.1.1 Creating and Changing “Digit treatment” Entries

**1** To configure a new entry, click the **New** button on the **Digit treatment** page.

To change the configuration of an existing entry click on the  icon left beside the entry.

---

<sup>1</sup> For Incoming Call/Calling Party Number: Depending on the capabilities of the DECT phone and the level of integration.

<sup>2</sup> For Outgoing Call/Called Number: If the user dials the number from the redial list again, the same procedure will be applied as for the initial dialing.



The **New digit treatment entry** or the **Configure digit treatment entry** dialog opens.

- 2 **External pattern:** Enter an external prefix pattern with up to 32 characters that matches an incoming call number or a number received via a directory entry. The prefix to be substituted for calling party numbers has the same character set as the user telephone number (e.g., :”+\*~#;,;-\_!\$%&/()=?09aAZ”).
- 3 **Internal pattern:** Enter an internal prefix pattern with up to 32 characters that replaces the external pattern for the directory entry / incoming calls or vice versa for outgoing calls. An internal prefix pattern can be composed of characters “\*”, ”#” and “0” – “9”.

**Please note:** The plus character (“+”) can only be dialed and transferred to a call log with a Mitel 600 DECT phone.

- 4 **Direction:** Select one of the following options:
  - “Incoming calls”: Rule applies on incoming calls.
  - “Outgoing calls”: Rule applies on outgoing calls.
  - “Incoming and outgoing calls”: Rule applies on incoming and outgoing calls.
  - “Apply on directory only”: Rule applies to directories only.
- 5 **Directory:** This option can be used to specify the rule for incoming and/or outgoing calls. Activate this option if the rule applies to directories.
- 6 **Sites:** Specifies the sites for which a rule is applied e.g. “1, 2” (see section 5.5). If set to “0”, the rule applies to all sites i.e. the rule will be applied to all calls or corporate directory requests.
- 7 Press the **OK** button.

### 5.9.1.2 Deleting “Digit treatment” Entries

To delete an existing entry:

- 1 On the **Digit treatment** page click on the  icon left behind the entry.  
The **Delete digit treatment entry?** dialog opens showing the current configuration of this entry.
- 2 Press the **Delete** button.

## 5.9.2 “DIRECTORY” MENU

The **Directory** menu allows you to manage connections to one or more LDAP, XML or XMI servers to support central corporate directories. The OMM supports multiple LDAP, XML or XSI servers with specific parameter settings to support different types of directories (e.g. global corporate directory, group specific directory, personal directory). XML-based directory services can be implemented using the XML terminal interface.

If there is more than one directory server configured, all are displayed on the DECT phone interface when the user invokes the Central Directory function. The user can choose one of the entries in the list. The name of an entry shown in the list is configured in the OMM when creating the directory server entry. The OMM determines the display order of the directories in the DECT phone menu by the order specified by the administrator.

You can configure up to five external directories. If only one directory server is configured, the name configured in the OMM is ignored, and the directory is accessed directly when the user presses the System softkey on the DECT phone (>>>) or selects the **Central directory** option from the menu.

### 5.9.2.1 Creating and Changing Directory Entries

You can configure directory entries (or change existing entries) from the **Directory** page (or the **Directory (comp. mode)** page for older SIP-DECT systems) in the OMM web interface. Parameters that require configuration depend on the type of directory you are configuring.

To change the configuration of an existing entry click the **Edit** icon () beside the entry, and follow the steps described below to set parameter values.

You can change the order of the directory entries by selecting a directory entry in the list and clicking the up or down arrows in the right panel (under **Tasks**). Changing the order of directory entries in the list changes the order in which they appear on the DECT phone.

To create or edit a directory entry, do the following:

- 1 Select the **Directory** entry in the **System Features** menu (left pane).
- 2 Click **New** on the **Directory** page, or click the pencil icon beside an existing directory entry in the list. The **New directory entry** (or **Configure directory entry**) dialog opens.

**Directory**

Active	<input type="checkbox"/>
Type	<input type="text" value="LDAP"/>
Name	<input type="text"/>
Search base	<input type="text"/>
Search type	<input type="text" value="Surname"/>
Display type	<input type="text" value="Surname, given name"/>
Server search timeout	<input type="text" value="10"/> sec
Protocol	<input type="text" value="HTTP"/>
Port	<input type="text"/>
Server	<input type="text"/>
User name	<input type="text"/>
Password	<input type="text"/>
Password confirmation	<input type="text"/>
Path (and parameters)	<input type="text"/>
Use common certificate configuration	<input type="checkbox"/>

3 Specify values for the directory server as described in the following table. Note that only certain parameters are required, depending on the directory server type.

Parameter	Description	LDAP	XML	XSI
<b>Active</b>	Enables or disables the directory entry on the DECT phone.	✓	✓	✓
<b>Type</b>	Interface type supported by the directory server. Possible values: <ul style="list-style-type: none"> <li>• LDAP</li> <li>• XML</li> <li>• XSI Enterprise</li> <li>• XSI Enterprise common</li> <li>• XSI Group</li> <li>• XSI Group common</li> <li>• XSI Personal</li> </ul>	✓	✓	✓
<b>Name</b>	Name to be displayed for the directory (Latin-1 character set is supported).	✓	✓	✓
<b>Search base</b>	Location in the directory from which the search begins (e.g., "ou=people, o=my com"). The configuration is valid for all DECT phones that support the LDAP directory feature. To make search requests unique for different users, the search base configuration can include placeholders that are replaced by user-specific values when submitting the LDAP request to a server. The following placeholders are defined: <ul style="list-style-type: none"> <li>• "&lt;TEL&gt;" (for the user's telephone number)</li> <li>• "&lt;DESC1&gt;" (for the user's "Description 1" attribute)</li> <li>• "&lt;DESC2&gt;" (for the user's "Description 2" attribute)</li> <li>• "SIPProxy" (for the current primary, secondary or tertiary SIP server address); supported for release 6.1 and later</li> </ul>	✓		

Parameter	Description	LDAP	XML	XSI
Search type	Attribute on which searches are performed ( <b>Surname</b> or <b>Given name</b> ).	✓		✓
Display type	Display mode for search results ( <b>Surname</b> , <b>First Name</b> or <b>Given name Surname</b> ).	✓		✓
Server search timeout	Interval (in seconds) during which the OMM waits for search results from the LDAP server (1 – 99 seconds).	✓		
Protocol	Transfer protocol used to communicate with the XML or XSI directory server ( <b>http</b> or <b>https</b> ).		✓	
Server port	Port for the LDAP directory server (default is 389). <b>Note:</b> SSL (default port 689) is not supported. Windows Active Directory Server uses port 3268.	✓		
Server	IP address or FQDN of the directory server.	✓	✓	✓
User name	Name of the account for directory server access, if required.	✓	✓	
Password	Password for directory server access, if required. <b>Note:</b> If no user/password is specified, an anonymous bind takes place. SIP-DECT supports LDAP simple bind.	✓	✓	
Path (and parameters)	URL (with parameters, if required) to the XML directory on the XML directory server.		✓	
Use common certificate configuration	Enables or disables use of the system's certificates (loaded for provisioning purposes) for HTTPS directory access		✓	✓

4 Click **OK** to save your changes.

### 5.9.2.2 Deleting Directory Entries

- 1 To delete an existing directory entry click on the  icon on the left of the entry on the **Directory** page. The **Delete directory entry** dialog opens showing the current configuration of this entry.
- 2 Press the **Delete** button.

### 5.9.3 “DIRECTORY (COMP. MODE)” MENU

With the introduction of XSI directory support in SIP-DECT 6.2, the underlying database model for directory support in SIP-DECT has changed. To support backwards compatibility, the **Directory (comp. mode)** page provides directory configuration and maintenance for existing SIP-DECT systems with LDAP or XML directory support.

To create or edit a directory entry using the old database model, do the following:

- 1 Select the **Directory (comp. mode)** entry in the **System Features** menu (left pane).
- 2 Click **New** on the **Directory (comp. mode)** page, or click the pencil icon beside an existing entry. The **New directory entry** (or **Configure directory entry**) dialog opens.

New directory entry

Directory

Active

Order 1 ▼

Type LDAP ▼

Name

Protocol HTTP ▼

Server name

Server port 389

Search base

User name

Password

Password confirmation

Search type Surname ▼

Display type Surname, given name ▼

Server search timeout 10 sec

Path (and parameters)

OK Cancel

3 In the **New directory entry** dialog (or the **Configure directory entry** dialog, for existing entries), specify values for the directory server as described in the following table. Note that only certain parameters are required, depending on the directory server type.

Parameter	Description	LDAP	XML
Active	Enables or disables the directory entry on the DECT phone.	✓	✓
Order	Specify where you want the directory entry to appear in the list.		
Type	Interface type supported by the directory server. Possible values: LDAP or XML.	✓	✓
Name	Name to be displayed for the directory (Latin-1 character set is supported).	✓	✓
Protocol	Transfer protocol used to communicate with the XML directory server ( <b>HTTP</b> or <b>HTTPS</b> ).		✓
Server name	IP address or FQDN of the directory server.	✓	✓
Server port	Port for the LDAP directory server (default is 389). <b>Note:</b> SSL (default port 689) is not supported. Windows Active Directory Server uses port 3268.	✓	
Search base	Location in the directory from which the search begins (e.g., "ou=people, o=my com"). The configuration is valid for all DECT phones that support the LDAP directory feature. To make search requests unique for different users, the search base configuration can include placeholders that are replaced by user-specific values when submitting the LDAP request to a server. The following placeholders are defined: <ul style="list-style-type: none"> <li>• "&lt;TEL&gt;" (for the user's telephone number)</li> <li>• "&lt;DESC1&gt;" (for the user's "Description 1" attribute)</li> <li>• "&lt;DESC2&gt;" (for the user's "Description 2" attribute)</li> <li>• "SIPProxy" (for the current primary, secondary or tertiary SIP server address); supported for release 6.1 and later</li> </ul>	✓	
User name	Name of the account for directory server access, if required.	✓	✓

Parameter	Description	LDAP	XML
Password	Password for directory server access, if required. <b>Note:</b> If no user/password is specified, an anonymous bind takes place. SIP-DECT supports LDAP simple bind.	✓	✓
Search type	Attribute on which searches are performed ( <b>Surname</b> or <b>Given name</b> ).	✓	
Display type	Display mode for search results ( <b>Surname</b> , <b>First Name</b> or <b>Given name Surname</b> ).	✓	
Server search timeout	Interval (in seconds) during which the OMM waits for search results from the LDAP server (1 – 99 seconds).	✓	
Path (and parameters)	URL (with parameters, if required) to the XML directory on the XML directory server.		✓

4 Click **OK** to save your changes.

### 5.9.4 “FEATURE ACCESS CODES” MENU

Feature access codes (FAC) allow a DECT phone user to perform specific actions on the OMM from any subscribed DECT phone.

To configure the FAC feature:

- 1 **FAC number:** Enter a unique FAC number.
- 2 Activate the appropriate checkbox(es) to enable the corresponding FAC feature(s). For each enabled FAC feature enter an assigned access code.
  - **Activate subscription:** activate subscription of the DECT phone.
  - **Activate wildcard subscription:** activate subscription of the DECT phone (if no IPEI is configured).
  - **Deactivate subscription:** de-activate DECT phone subscription.
  - **User login:** log the user into the DECT phone.
  - **User logout:** log the user out of the DECT phone.

- **Set system credentials for provisioning:** allow a user to set system credentials via the Mitel 600 DECT phone.
- **Blind transfer:** initiate a blind transfer from the DECT phone. When a user dials the “Blind transfer” FAC en-bloc (in an active call state) followed by a target number, SIP-DECT initiates a blind transfer to the given target number.

3 Press the **OK** button.

Afterwards the appropriate action can be performed by dialing the “FAC number” followed by the “FAC access code” en-bloc from any subscribed DECT phone.

In the example above a subscribed user can activate the OMM DECT subscription by dialing “\*134567” en-bloc.

**Please note:** Overlap sending is not supported for FAC. “FAC number” and “FAC action code” must be entered en-bloc.

FAC functions will be confirmed by an audible indication to the user (in-band tone signals).

### 5.9.5 "XML APPLICATIONS" MENU

The SIP-DECT XML terminal interface allows external applications to provide content for the user on the Mitel 600 DECT phone display. To make the XML terminal interface applications available for the DECT phone user, you must configure the appropriate hooks in the **XML Applications** menu.

When the application hook is enabled in the OMM, Mitel 600 DECT phone users can program a softkey with the specific hook (or select the relevant menu option) to trigger the associated action. The side keys on the Mitel 600 DECT phones only display icons in idle state. In an active call state only the two softkeys below the display indicate the active feature.

Status	XML Applications		
System	<input type="button" value="New"/>		
Sites			
Base Stations	15 XML Applications		
DECT Phones	Name	URL	Active
WLAN	Caller list	http://	×
System Features	Redial list	http://	×
Digit Treatment	Presence	http://	×
Directory	Server menu	http://	×
Feature Access Codes	Action URI	http://	×
XML Applications	Feature access codes	http://	×
Licenses	Call completion	http://	×
Info	Park call	http://	×
	Unpark call	http://	×
	Pickup	http://	×
	Take	http://	×
	Call forward	http://	×
	Call routing	http://	×
	Call protection	http://	×
	Voice box	http://	×

The following table summarizes the predefined XML application hooks:

Hook	Description	DECT Phone menu
<b>Caller list</b>	Hook to replace the local caller list.	>>> > <b>Info</b> > <b>Caller List</b>
<b>Redial list</b>	Hook to replace the local redial list.	>>> > <b>Info</b> > <b>Redial List</b>
<b>Presence</b>	Hook to reach a presence application .	>>> > <b>Presence</b>
<b>Server menu</b>	Hook to reach a server menu. The OMM system menu is available as a menu entry in the local main menu of the DECT phone (>>> softkey). If no user is assigned to the DECT phone, the server menu is the only available XML application hook.	>>> > <b>Info</b> > <b>Server</b>
<b>Action URI</b>	URI to be called in case of user/device events. The URI is configured in the OMM via OMP. Content can be pushed towards the DECT phone via SIP notify.	n/a
<b>Feature access codes</b>	Hook to provide Feature Access Codes translation.	
<b>Call completion</b>	Hook to provide callback option when a user places an outgoing call and wants to request a callback before releasing the call.	>>> > <b>Info</b> > <b>Callback</b>
<b>Park call</b>	Hook to the Park Call service interface.	>>> > <b>Call option</b> > <b>Park call</b>
<b>Unpark call</b>	Hook to the Unpark Call service interface.	>>> > <b>Unpark call</b>
<b>Pickup</b>	Hook to the Pickup Call service interface.	>>> > <b>Pickup</b>
<b>Take</b>	Hook to Take Call service interface.	>>> > <b>Take</b>
<b>Call forward</b>	Hook to the Call Forward service interface.	>>> > <b>Call forward</b>
<b>Call routing</b> (Mitel 602 DECT phones only)	Hook to the Personal Call Routing service interface.	>>> > <b>Call routing</b>
<b>Call protection</b> (Mitel 602 DECT phones only)	Hook to the PBX call protection service interface.	>>> > <b>Call protection</b>
<b>Voice box</b>	Hook to Voice Mail service interface.	>>> > <b>Info</b> > <b>Voice box</b>

These hooks can be activated or deactivated but not deleted. You can create up to 10 additional hooks dynamically.

**Note:** The “Call forward” XML hook replaces the “Call forwarding / diversion” supplementary service. When activated, the “Call forwarding / diversion” supplementary service is automatically deactivated and all user specific settings are removed.

For more information on creating, activating or deleting XML hooks, see section 6.12.7.

## 5.10 “LICENSES” MENU

The **Licenses** page provides an overview on the currently used license. On this page you can also import an activation or license file:

- 1 Select the path and file name where the activation or license key is stored.
- 2 Click the **Import** button.

For a detailed description on the OMM licensing model see section 3.32.



## 5.11 “INFO” MENU

The **Info** page displays the End User License Agreement (EULA).

With the first login to a new SIP-DECT software version, this page is displayed automatically and the user must accept the EULA by clicking the **Accept** button.

## 6 OM MANAGEMENT PORTAL (OMP)

The OM Management Portal (OMP) is a Java tool used to manage the SIP-DECT solution. It can be used to view and configure OMM system data and has integrated monitoring and other maintenance features.

SIP-DECT supports Java web start to start the OMP. Java 1.7 is required to run OMP 5.0 or later. By default, the source for the OMP binary is a Mitel web server (RFP-OMM) or the OMP.jar from the RPM installation (PC-OMM).

You can also configure a different source (**System settings** -> **OMP web start** in the OMM Web service, or **System** -> **Advanced settings** -> **Additional services – OMP web start** in the OMP). The following configuration order is used:

- GUI-configured OMP web start URL in RFP-OMM installations
- Environment variable 'OM\_WebStartUrl' (e.g. set by ipdect.cfg configuration file)
- Mitel web server (RFP-OMM) / from RPM installation (PC-OMM)

You can download the OMP jar file from the OMM Web service by clicking on the OMP link in the top bar:

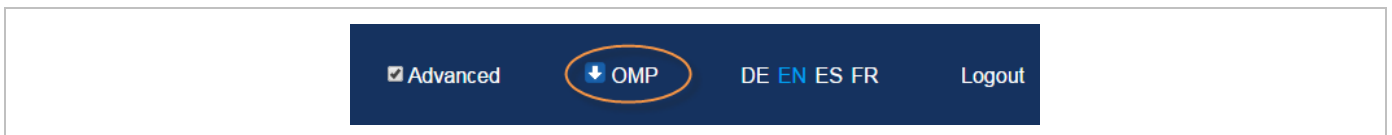

Double-click on the downloaded file (OMP.jnlp) and click “Run” in the dialog window. The OM Management Portal starts and prompts for login credentials.

**Please note:** Configuration of a non-default source must not contain login credentials because this is not supported by the Java Web Start mechanism. The HTTP/FTP server must be configured accordingly.

This section lists all parameters which can be configured and viewed using OMP. All parameters which are also accessible by the OM Web service are described in the appropriate OM Web service section (section 5). New parameters which are only accessible via OMP are described in this section.

### 6.1 LOGIN

The OMM allows more than one user at a time to configure the system.

To log in to the system enter the following data:

- **IP address** of the OMM.
- **User name, Password:** Enter a user name and a password. Both strings are checked case sensitive. With initial installation or after removing the configuration file, the OMM Web service is accessible via a default built-in user account with user “omm” and password “omm”.

The **System name** is set by the system administrator after first successful login to the OMM, see section 6.5.1.



The system name and the IP address of successful logins are stored in the local OMP preferences and can be reselected for further logins. Up to 10 different login datasets can be stored.

- On a Linux system, preferences are stored in the user's home directory "~/.java/.userPrefs/...".
- On a Windows system, preferences are stored in the registry node "HKEY\_CURRENT\_USER/Software/JavaSoft/Prefs/...".

After login the OMP is set to the configuration mode page showing the system status page which contains health state information of the connected OMM (see section 6.4). If there is a version difference between the OMP and the OMM, this will also be indicated here. Details can be viewed in the **Help: About AXI** menu (see section 6.15).

## 6.2 LOGOUT

There is no automatic logout for the OMP. The user must log out manually.

To log out from the system:

- click on the Close icon in the upper right corner of the OMP window
- select the **Exit** entry from the **General** drop-down menu.

**Note:** If the OMM link is broken, the OMP asks if you want to reconnect to the OMM. In that case, you must enter the login data again.

## 6.3 OMP MAIN WINDOW



The header of the OMP window shows the version of the connected OMM.

### “OMP mode” toolbar buttons

The OMP provides different modes: **configuration mode**, **monitor mode** and **planning mode**.

Configuration mode allows changing of parameters. In monitor mode, parameters are only displayed, but are not changeable. Monitor mode provides additional features, e.g. system and RFP statistics and RFP synchronization monitoring. Planning mode enables the creation of graphics which can be used with the OM Locating application to visualize the placement of the RFPs (see also /27/).

To select the desired mode, press the appropriate button in the upper toolbar of the OMP window:

-  Configuration mode
-  Monitor mode
-  Planning mode

### Main menus

The OMP provides two main menus which are available in all program situations:

- **General** menu, see section 6.14.
- **Help** menu, see section 6.15.

### Navigation panel

Both configuration and monitor mode contain a navigation panel. This panel contains the mode-dependant menu.

### Status bar

The status bar is located at the bottom of the main window. It shows the following items:

- Encryption state:

The  icon indicates that encryption is enabled.

The  icon indicates that encryption is disabled.

This setting can be configured in the **DECT** tab of the **System settings** menu (see also section 6.5.1).

- PARK,
- Subscription state: Clicking on one of the following icons enables / disables subscription.

The  icon indicates that subscription is enabled.

The  icon indicates that subscription is disabled.

Subscription can also be enabled / disabled in the **DECT phones** menu (see also section 6.7.8).

- Auto-create on subscription state: Clicking on one of the following icons enables / disables Auto-create on subscription.

The  icon indicates that Auto-create on subscription is enabled.

The  icon indicates that Auto-create on subscription is disabled.

This setting can also be configured in the **DECT** tab of the **System settings** menu (see also section 6.5.1).

- Connection status to the OMM:



If connected to the OMM, the IP address of the OMM is displayed.



OMP is disconnected from the OMM.

### Info console

General OMP events are displayed the **Info console**.

## 6.4 “STATUS” MENU

The system status is displayed after startup of OMP. The **Status** panel provides information about the system health states, and contains the following tabs:

- Overview (see section 6.4.1)
- DECT base stations (see section 6.4.2)
- Users (see section 6.4.3)
- Devices (see section 6.4.4)
- Sites (see section 6.4.5)
- Conference (see section 6.4.6)
- Video devices (see section 6.4.7)

### 6.4.1 OVERVIEW

The “Overview” tab consists of a “System” panel providing general system health states information and a “Features” panel which shows health states of system features. Some of these features are optional; that means the relevant health state is only shown if the feature is activated in system.

The screenshot displays the 'Overview' tab of the OMP Status menu. It features two main panels: 'System' and 'Features'. The 'System' panel lists various system components with their health status, indicated by green checkmarks or a timer. The 'Features' panel lists optional features with their health status, indicated by green checkmarks or a red 'X'.

System Component	Health Status
Uptime	3 Day(s) 01 h 56 min
Licenses	✓
Standby OMM (10.37.18.31)	✓
Synchronization state	✓
DECT base stations	✓
SIP	✓
DB import/export	✓
Downloading new firmware to portable parts	✓
Provisioning server	✓
OMM configuration file processing	✓

Feature	Health Status
OM Integrated Messaging & Alerting service	✓
Configuration over air	✓
User data server	✓
SIP certificate server	✗



The “Overview” tab shows following system information:

- **System uptime:** Elapsed time since OMM start (in days, hours and minutes)
- **Licenses:** Licenses health state
- **Standby OMM:** Standby OMM IP address and health state of standby configuration (if no standby OMM is configured a grey cross is shown)
- **Synchronization state:** Synchronization health state
- **DECT base stations:** Base stations health state
- **SIP:** SIP health state
- **DB import/export:** DB import/export health state
- **Downloading new firmware to portable parts:** (Health) state of firmware download to DECT phones
- **Provisioning server:** Health state of provisioning server health state
- **OMM configuration file processing:** Health state of configuration file processing.

Depending on OMM system configuration, the “Features” tab consists of all or a subset of these health states:

- **OM Integrated Messaging & Alerting service:** Messaging and alerting feature health state (always active)
- **SIP certificate server:** SIP certificate server health state (always active)
- **Configuration over Air:** Central DECT phone configuration over air state (optional)
- **User data server:** User data server health state (optional)
- **User monitoring:** User monitoring health state (optional)
- **Video:** Video health state (optional)

Health states can have the following values:

-  – inactive or unknown
-  – error
-  – OK

## 6.4.2 DECT BASE STATIONS

The “DECT base stations” tab contains the following sections: “General”, “DECT” and “WLAN”.

Section	Metric	Value
General	Total	12
	Connected	2
	Invalid branding	0
	Standby misconfigured	0
	Version mismatch	0
	Software update	0
	USB overload	0
	Encryption not supported	0
	Advanced features not supported	0
DECT	DECT switched on	12
	DECT running	2
	Used clusters	2
	Used paging areas	1
WLAN	WLAN switched on	0
	WLAN running	0
	Profiles	0

The “General” panel provides counters related to RFP configuration and state:

- **Total:** Total number of RFPs configured
- **Connected:** Number of RFPs connected to OMM
- **Invalid branding:** Number of connected RFPs with invalid branding
- **Standby misconfigured:** Number of connected RFPs with wrong standby configuration
- **Version mismatch:** Number of connected RFPs running with wrong software version
- **Software update:** Number of connected RFPs requesting software update
- **USB overload:** Number of connected RFPs detecting overload at their USB port
- **Encryption not supported:** Number of connected RFPs not supporting encryption
- **Advanced features not supported:** Number of connected RFPs not supporting “Advanced features” which covers “Hi-Q audio technology”, “Terminal video”, “Enhanced DECT security” and “SRTP”.

The “DECT” panel provides counters related to RFPs DECT configuration and state:

- **DECT switched on:** Number of configured RFPs with DECT switched on
- **DECT running:** Number of connected RFPs with DECT running
- **Used cluster:** Number of configured clusters
- **Used paging areas:** Number of paging areas used by RFPs

The “WLAN” panel provides counters related to RFPs WLAN configuration and state:

- **WLAN switched on:** Number of configured RFPs with WLAN switched on
- **WLAN running:** Number of connected RFPs with WLAN running
- **Profiles:** Number of WLAN profiles used by RFPs

### 6.4.3 USERS

The “Users” tab provides information about DECT phone users.

Category	Item	Value
General	Total	84
	SIP registered	4
	Monitored active	0
	Monitored passive	0
	Sending messages permission	0
	DECT locatable	0
User monitoring states	Warning	0
	Unavailable	0
	Escalated	0
Number for visibility checks	Number/ SIP user name	25052

The “General” panel provides counters concerning DECT phones user configuration and states:

- **Total:** Total number of configured users
- **SIP registered:** Number of configured users registered at SIP server
- **Monitored active:** Number of configured users with active monitoring enabled
- **Monitored passive:** Number of configured users with passive monitoring enabled
- **Sending messages permission:** Number of configured users with message sending permission enabled
- **DECT locatable:** Number of configured users with DECT locatable enabled

The “User monitoring states” panel provides counters concerning DECT phone user monitoring state

- **Warning:** Number of monitored users in state ‘Warning’
- **Unavailable:** Number of monitored users in state ‘Unavailable’
- **Escalated:** Number of monitored users in state ‘Escalated’

The “Number for visibility checks” panel provides phone number or SIP user name used for standby OMM visibility checks.



## 6.4.4 DEVICES

The “**Devices**” tab provides information about DECT phones.

The screenshot shows the 'Devices' tab in the OMP interface. It features a navigation bar with tabs for Overview, DECT base stations, Users, Devices (selected), Sites, Conference, and Video devices. The main content is divided into two panels:

- General:** Contains two counters: 'Total' with a value of 84 and 'Subscribed' with a value of 4.
- Downloading new firmware to portable parts:** Shows the status of a firmware download. The status is 'Success' (indicated by a green checkmark). The 'Loading firmware from' field contains the URL 'tftp://10.37.18.35/600.dnld'. The 'Firmware version' field contains '[600: 5.00.SP5.RC1] - [650,602: 6.0.RC8]'. Below these are several counters for different states: 'Known downloadable' (4), 'Already updated' (4), 'Waiting for download' (0), 'Currently downloading' (0), 'Barred' (0), 'Download error' (0), 'Unreachable' (0), and 'Detached' (0).

The “General” panel contains counters related to DECT phones:

- **Total:** Total number of configured DECT phones
- **Subscribed:** Number of configured DECT phones which are subscribed to OMM

The “Downloading new firmware to portable parts” panel provides information about state of DECT phone firmware download:

- **Status:** Status of firmware download
- **Loading firmware from:** URL of firmware download container
- **Firmware version:** Version info of firmware container
- **Known downloadable:** Number of DECT phones known as downloadable
- **Already updated:** Number of DECT phones already updated
- **Waiting for download:** Number of DECT phones waiting for download
- **Currently downloading:** Number of DECT phones currently downloading
- **Barred:** Number of downloadable DECT phones currently barred
- **Download error:** Number of downloadable DECT phones with download error
- **Unreachable:** Number of downloadable DECT phones currently unreachable
- **Detached:** Number downloadable DECT phones currently detached

### 6.4.5 SITES

The “**Sites**” tab provides counters concerning site configuration and state:



- **Total:** Total number of configured sites
- **Contains RFPs:** Number of sites with dedicated RFPs
- **Hi-Q audio technology:** Number of sites with Hi-Q audio technology enabled
- **Enhanced DECT security:** Number of sites with “Enhanced DECT security” enabled
- **Secure real time transport protocol:** Number of sites with “Secure real time transport protocol” (SRTP) enabled
- **Terminal video:** Number of sites with terminal video enabled

### 6.4.6 CONFERENCE

The “**Conference**” tab provides conference channel information:



- **Total:** Total number of conference channels in system
- **Available:** Number of currently available conference channels

## 6.4.7 VIDEO DEVICES

The “**Video devices**” tab provides video device state information.

The “General” panel provides video device configuration related counters:

- **Total:** Total number of configured video devices
- **Checkpoint:** Number of video devices enabled

The “State” panel provides video device state related counters:

- **Unplugged:** Number of video devices in state unplugged
- **Inactive:** Number of video devices in state inactive
- **Active:** Number of video devices in state active
- **Failure:** Number of video devices in state failure

## 6.5 “SYSTEM” MENU

The **System** menu allows configuration and display of global OMM settings. The system settings are changeable in configuration mode. Change of some parameters can cause the OMM to be reset. In this case a new login is required.

The **System** menu provides the following entries:

Configuration mode	Monitor mode	See section
Basic settings	Basic settings	6.5.1
Advanced settings	Advanced settings	6.5.2
	Statistics	6.5.3
SIP	SIP	6.5.4
User administration	User administration	6.5.6
Data management	Data management	6.5.7

## 6.5.1 “BASIC SETTINGS” MENU

The **Basic settings** menu contains general settings for the OpenMobility Manager and contains the following tabs:

- General (see section 6.5.1.1)
- DECT (see section 6.5.1.2)
- WLAN (see section 6.5.1.3)
- Software update URL (only on systems where the OMM is running on a DECT base station) (see section 6.5.1.4)

### 6.5.1.1 General settings

The screenshot shows the 'Basic Settings' menu with the 'General' tab selected. The settings are organized into three main sections:

- General:**
  - System name: Customer
  - Remote access:
  - Tone scheme: US
  - Time zone: Eastern (EST UTC-5 DST)
- SysLog:**
  - Active:
  - IP address: 10.35.19.23
  - Port: 514
- RFP software update:**
  - Mode: One by one
  - Time-controlled:
  - Time of day: 11:25

At the bottom of the form are four buttons: OK, Cancel, Update, and Restart.

The following parameters can be set on the General tab of the “Basic Settings” menu.

#### General

- **System name:** Name of the SIP-DECT system.
- **Remote access:** Enables or disables SSH access to all RFPs in the DECT system. For more information on SSH access, see section 8.3.5.
- **Tone scheme:** Specifies the country in which the OMM resides, which enables country-specific tones (e.g., busy tone, dial tone, etc).
- **Time zone:** Specifies the time zone in which the OMM is operating.

#### Syslog

- **Active:** Enables propagation of syslog messages by the OMM and RFPs.
- **IP address:** Address of the host that collects the syslog messages.
- **Port:** Port of the host that collects the syslog messages.
- **Forward OMM Messages to syslog:** (Visible only on a PC-hosted OMM system) Enables/disables forwarding of syslog messages from the PC-hosted OMM.

### RFP software update

- **Mode:** RFP update mode. Options are “One by one” (each RFP is updated separately) or “All at once” (all RFPs are updated in one operation).
- **Time-controlled:** Indicates whether the start of the RFP update is time-controlled.
- **Time of day:** Specifies the time for time-controlled RFP updates.

**Note:** Updates triggers can be controlled through update intervals (DHCP, config files) or manually triggered via the **Update** button.

The “General” tab contains two additional buttons (aside from default buttons):

- **Update:** Requests an immediate update of RFP software.
- **Restart:** Requests an OMM restart.

### 6.5.1.2 DECT settings

For a description of the parameters which can be set in the **DECT** tab, see the description of the **System settings** page of the OMM Web service (see section 5.4.1). The corresponding parameters are described in the **DECT settings** and **Downloading new firmware to portable parts** page sections, with the exceptions noted below.

The screenshot shows the DECT settings configuration page. The left sidebar contains a navigation menu with options like Status, System, Basic settings, Advanced settings, SIP, Provisioning, User administration, Data management, Sites, DECT base stations, WLAN, Video devices, DECT phones, Conference rooms, System features, and Licenses. The main content area is titled 'Configuration' and has tabs for 'General', 'DECT', 'WLAN', and 'Software update URL'. The 'DECT' tab is active, showing the following settings:

- PARK:** 1F102643C7
- SARI:** (empty field) with a **Generate SARI** button.
- DECT authentication code:** 2222
- Regulatory domain:** US (FCC/IC) with a dropdown arrow and a note: "When changing the DECT regulatory domain all radio fixed parts will be reset."
- Paging area size:** 256 RFPs (1 Paging area) with a dropdown arrow.
- DECT power limit 100mW:**
- Encryption:**
- Restricted subscription duration:**
- Auto-create on subscription:**
- Portable part user login type:** Number/SIP user name with a dropdown arrow.
- Preserve user device relation at DB restore:**

At the bottom, there are **OK** and **Cancel** buttons, and a note: "Changing these settings may cause the OpenMobility Manager to be reset."

The following settings are only available in the OMP.

- **Regulatory domain:** the OMP offers an additional regulatory domain selection (Radio 1910-1927MHz 250mW) for SIP-DECT operation in some South American countries. See section 3.11 for more information on this feature.
- **SARI:** Specify the Secondary Access Rights Identifier (SARI) for the Dual Homing feature. DECT phones subscribe to the SARI (instead of the PARK) to ensure that user data is synchronized across all OMMs in the system. See section 7.16 for more information on this feature. You can click the **Generate SARI** button to generate the SARI from the system PARK code.

- **Paging area size:** Select the number of paging areas for the SIP-DECT system. A paging area can consist of up to 256 RFPs (and the smallest group can consist of 16 RFPs). The configuration of the paging areas is done in the **Paging areas** menu of the OMP (see section 6.7.2).
- **Restricted subscription duration:** Restricts the time period throughout which a DECT phone can be subscribed to 2 minutes. Furthermore, the subscription mode will be disabled immediately after every successful subscription of a DECT phone.
- **Auto-create on subscription:** Activate this option if an unbound subscription of DECT phones should be allowed. See *the OM DECT Phone Sharing and Provisioning Guide* for more information.

### 6.5.1.3 WLAN settings

For a description of the parameters which can be set in the **WLAN** tab, see the description of the **System settings** page of the OMM Web service. The same parameters are described in the **WLAN settings** section (section 5.4.1.3).

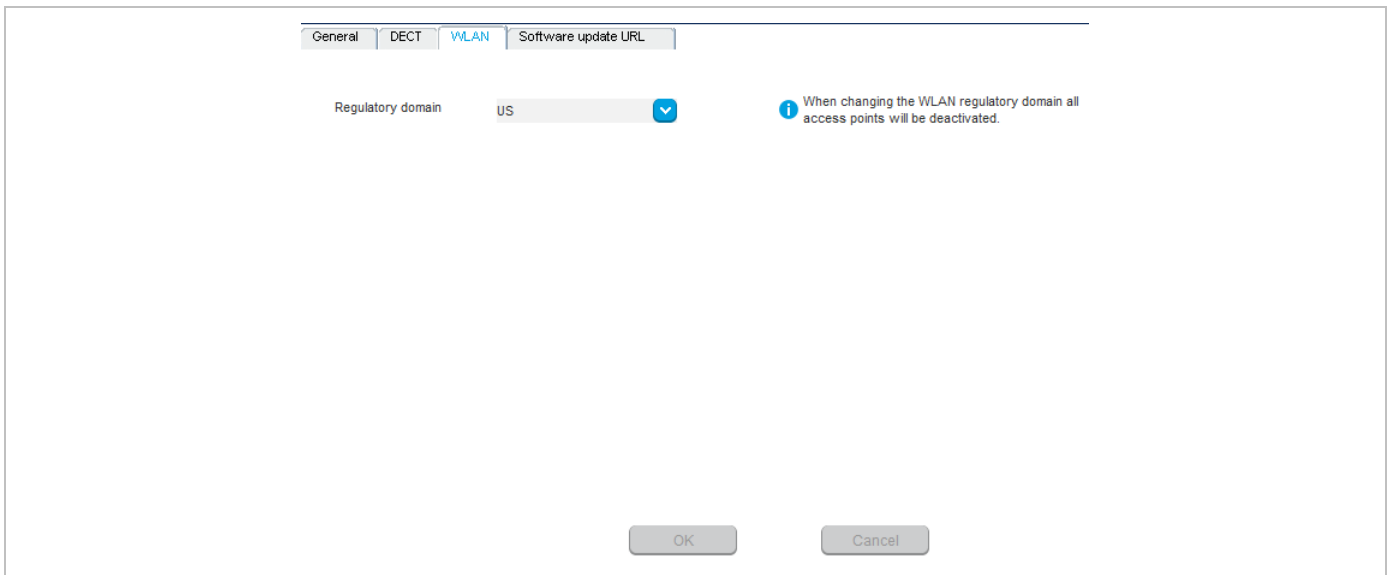

The screenshot shows a configuration window with four tabs: 'General', 'DECT', 'WLAN', and 'Software update URL'. The 'WLAN' tab is active. Under 'Regulatory domain', a dropdown menu shows 'US' with a blue arrow icon. To the right, an information icon (i) is followed by the text: 'When changing the WLAN regulatory domain all access points will be deactivated.' At the bottom of the window, there are two buttons: 'OK' and 'Cancel'.

### 6.5.1.4 Software Update URL settings

With SIP-DECT 6.0 or later, DECT base stations in small SIP-DECT systems (~10 RFPs) can obtain their software image from the RFP OMM, if they have no valid URL from which to load their software. If the OMM is running on a RFP, the RFP OMM delivers the software to the connected RFPs.

You configure the URL for the RFP software image (iprfp3G.dnld ) on this tab. This tab is only available when the OMM resides on an RFP.

General DECT WLAN Software update URL

Software update URL

Configure specific source

Protocol TFTP

Port 69 Use default port

Server 10.37.18.35

User name

Password

Password confirmation

Path /prfp3G.dnld

Use common certificate configuration

OK Cancel

For a description of the parameters that can be set in the **Software update URL** tab, see the description of the **System settings** page of the OMM Web service. The same parameters are described in the **Software update URL** section (section 5.4.1.10).

## 6.5.2 “ADVANCED SETTINGS” MENU

The **Advanced settings** menu contains additional settings for the OpenMobility Manager, and contains the following tabs:

- Net parameters (see section 6.5.2.1)
- DECT phones (see section 6.5.2.2)
- DECT phone firmware (see section 6.5.2.3)
- IMA (see section 6.5.2.4)
- Additional services (see section 6.5.2.5)
- User monitoring (see section 6.5.2.6)
- Special branding (see section 6.5.2.7)
- Core dump (see section 6.5.2.8)
- Remote system dump (see section 6.5.2.9)
- OMM certificate (see section 6.5.2.10)
- OMM certificate server (see section 6.5.2.11)
- SNMP (see section 6.5.2.12)
- Time zones (see section 6.5.2.13)

### 6.5.2.1 Net parameters

For a description of the parameters that can be set in the **Net parameters** tab, see the description of the **System settings** page of the OMM Web service. The same parameters are described in the **Net Parameters** section (section 5.4.1.13).

The screenshot shows a configuration window with a tabbed interface. The 'Net parameters' tab is active. The configuration options are as follows:

Parameter	Value
Input format QoS parameter	ToS
QoS for voice packets (ToS)	88
QoS for voice packets (DiffServ)	46
QoS for signalling packets (ToS)	88
QoS for signalling packets (DiffServ)	46
TTL (Time to live)	32
802.1p voice priority	6
802.1p signaling priority	6

Buttons for 'OK' and 'Cancel' are located at the bottom of the window.

- **Input format QoS parameter:** format for quality of service parameter. Available options are ToS or DiffServ.
- **QoS for voice packets:** Specifies the value of the type of service (ToS ) or DiffServ byte (depending on the QoS input format value) of the IP packet header for all packets that transport RTP voice streams.
- **QoS for signalling packets:** Specifies the value of the type of service (ToS ) or DiffServ byte (depending on the QoS input format value) of the IP packet header for all packets related to VoIP signaling.
- **TTL (Time to live):** Specifies the maximum hop count for all IP packets.
- **802.1p voice priority:** Specifies the VLAN priority tag for RTP packets.
- **802.1p signaling priority:** Specifies the VLAN priority tag for VoIP signaling packets.



### 6.5.2.2 DECT Phones

The OMM can set certain start-up text settings on the DECT Phone over the air. For more information on this feature see section 3.13.5.

Core dump	Remote system dump	OMM certificate	OMM certificate server	SNMP	Time zones
Net parameters	<b>DECT phones</b>	DECT phones firmware	IMA	Additional services	User monitoring
					Special branding

Dial editor supports digits only	<input checked="" type="checkbox"/>
Set startup window headline	<input type="checkbox"/>
Startup window headline	<input type="text"/>
Set startup window text	<input type="checkbox"/>
Startup window text	<input type="text"/>
Truncate portable part user name	<input type="checkbox"/>

- **Dial editor supports digits only:** enables a digits-only mode for the DECT phone dial editor. In this mode, the "\*" has the meaning of a digit to be dialed, even if short-pressed. If the mode is not enabled, a short press of the "\*" key changes the editor mode to alphanumeric.
- **Set startup window headline:** Enables display of the text string specified in the **Startup window headline** field.
- **Startup window headline:** text headline to be displayed in the DECT phone window at startup. Default value is "my company".
- **Set startup window text:** Enables display of the text string specified in the **Startup window text** field.
- **Startup window text:** text string to be displayed in the DECT phone window at start. Empty by default.
- **Truncate portable part user name:** Enables or disables truncating the name of the user registered to the DECT phone.

### 6.5.2.3 DECT phones firmware

The OMM can provide a DECT phone firmware update over the air. If the **Activate firmware update** checkbox is enabled, the “Download over Air” feature is activated. For more information on this feature see section 7.22.

The screenshot shows the 'DECT phones firmware update' configuration window. The window has a title bar with tabs: Core dump, Remote system dump, OMM certificate, OMM certificate server, SNMP, Time zones, Net parameters, DECT phones, DECT phones firmware (selected), IMA, Additional services, User monitoring, and Special branding. The main content area is titled 'DECT phones firmware update' and contains the following fields and controls:

- Activate firmware update:
- Configure specific source:
- Protocol: TFTP (dropdown menu)
- Port:  Use default port:
- Server:
- User name:
- Password:
- Password confirmation:
- Path:
- Use common certificate configuration:

At the bottom of the window are two buttons: OK and Cancel.

For a description of the parameters on the **DECT Phone firmware** tab, see section 5.4.1.6.

### 6.5.2.4 IMA

The Integrated Message and Alarm (IMA) configuration is stored in the OMM database. You can configure a specific URL for the OMM to retrieve the IMA configuration file (ima.cfg). The IMA configuration remains available even if the configured server becomes unavailable.

When you set a specific URL, the OMM uses that URL to load the IMA configuration file during startup. If no specific IMA configuration file source is configured, the provisioning server settings (ConfigURL) are used to retrieve the 'ima.cfg' file.

Core dump	Remote system dump	OMM certificate	OMM certificate server	SNMP	Time zones
Net parameters	DECT phones	DECT phones firmware	<b>IMA</b>	Additional services	User monitoring
Special branding					

**OM Integrated Messaging & Alerting service**

Configure specific source

Protocol None

Port  Use default port

Server

User name

Password

Password confirmation

Path (including file name)

Use common certificate configuration

Internal message routing (DECT phone <-> DECT phone)

For a description of the parameters on the **IMA** tab, see the description of the **System settings** page of the OMM Web service. The same parameters are described in the **OM Integrated Messaging & Alerting service** section (section 5.4.1.8).

### 6.5.2.5 Additional services

For a description of the parameters on the **Additional services** tab, see the description of the **System settings** page of the OMM Web service. The same parameters are described in the following sections:

- **Voice mail** (section 5.4.1.7)
- **OMP web start** (section 5.4.1.5)
- **Date and time** (for NTP servers) (section 5.4.1.14)

Core dump	Remote system dump	OMM certificate	OMM certificate server	SNMP	Time zones
Net parameters	DECT phones	DECT phones firmware	IMA	Additional services	Special branding

**Voice mail**

Voice mail number

---

**OMP web start**

Configure specific source

Protocol None ▼

Port  Use default port

Server

Path

---

**NTP server settings**

NTP Server 1

NTP Server 2

NTP Server 3

Default

OK
Cancel

### 6.5.2.6 User monitoring

The **User monitoring** tab allows you to configure the system-wide parameters for the user monitoring feature.

Core dump	Remote system dump	OMM certificate	OMM certificate server	SNMP	Time zones
Net parameters	DECT phones	DECT phones firmware	IMA	User monitoring	Special branding

Locating escalation

Startup delay  min

Escalation delay  min

Activity timeout 1 (Passive monitoring)  min

Activity timeout 2 (Active monitoring)  min

Battery threshold  20 ▼ %

OK
Cancel

- **Locating escalation:** If this option enabled, the alarm trigger “LOC-ERR-USERSTATE” will be generated by the OMM. Default setting is “off”.

- **Start-up delay:** The start-up delay defines the period of time the user monitoring start-up is delayed (between 2 and 15 minutes) after failover or system start-up.
- **Escalation delay:** The escalation delay defines the period of time the user monitoring will wait before the unavailable status is escalated.
- **Activity timeout 1:** The activity timeout 1 defines the maximum time (between 30 and 1440 minutes) between user activities in passive monitoring mode.
- **Activity timeout 2:** The activity timeout 2 defines the maximum time (between 5 and 60 minutes) between user activities in active monitoring mode.
- **Battery threshold:** The battery threshold defines the minimum battery load (between 0 and 100% in steps of 5%).

### 6.5.2.7 Special branding

With SIP-DECT 6.0 or later, you can integrate a customer-specific logo into the OMM Web service interface (displayed beside the Mitel logo in the top bar). The "Special Branding" tab allows you to specify the location of the branding image file (customer\_image.png) on an external file server.

When you set a specific URL, the OMM uses that URL to load the image file during startup. If no specific customer logo file source is configured, the provisioning server settings (ConfigURL) are used to retrieve the image file.

The branding image is stored permanently in the OMM database. The file is deleted automatically when the branding image URL configuration is disabled. The picture should not be larger than 50 pixels high and 216 pixels wide.

By special request, you can use specific branding key to lock the OMM; the key must be branded to all DECT phones before they can be subscribed. See section 7.25 for more information on this feature.

Core dump Remote system dump OMM certificate OMM certificate server SNMP Time zones  
 Net parameters DECT phones DECT phones firmware IMA Additional services User monitoring **Special branding**

**PP branding key**

Active key

New key

**Branding image URL**

Configure specific source

Protocol **HTTPS**

Port  Use default port

Server

User name

Password

Password confirmation

Path  /customer\_image.png

Use common certificate configuration

OK Cancel

### PP Branding key

- **Active key:** Displays the current branding key associated with the DECT phones.
- **New key:** Specifies the new branding key generated through the `DECTSuiteBrandingInstallation.exe` utility.

### Branding image URL

- **Active:** Enables the specific URL for downloading the `customer_image.png` file (as opposed to the `ConfigURL`, which points to an external file server for all configuration and resource files).
- **Protocol:** Specifies the protocol used to fetch the image file.
- **Port:** Specifies the port of the external file server.
- **Server:** Specifies the IP address or name of the external file server.
- **User name:** Specifies the user name to authenticate on the external file server.
- **Password:** Specifies the password to authenticate on the external file server.
- **Password confirmation:** Confirms the password to authenticate on the external file server.
- **Directory:** Specifies the location of the image file on the external file server.
- **Use common certificate configuration:** Enables the use of the same certificate validation settings for the image file URL as specified for the `ConfigURL`.

### 6.5.2.8 Core Dump

Fatal software problems may result in memory dumps, in core files. The IP RFP can transfer the core files to a remote fileserver. With SIP-DECT 6.0 or later, you can configure a specific URL to an external file server where core dump files should be transferred and stored. The Core dump URL is used by each RFP connected to the OMM.

Without a configured Core dump URL, whether and where core files are transferred is dependent on specific RFP settings. Without any special configuration, the files are transferred to the server that is used to retrieve the system software (i.e., the directory of the boot image).

The screenshot shows the OMM Web service configuration page with the 'Core dump' tab selected. The page has a navigation bar with tabs: Net parameters, DECT phones, DECT phones firmware, IMA, Additional services, User monitoring, and Special branding. Below the navigation bar, there are sub-tabs: Core dump (selected), Remote system dump, OMM certificate, OMM certificate server, SNMP, and Time zones. The 'Core dump' configuration area includes the following fields and controls:

- Configure specific destination:** A checkbox that is currently unchecked.
- Protocol:** A dropdown menu set to 'TFTP'.
- Port:** An empty text input field next to a checked 'Use default port' checkbox.
- Server:** An empty text input field.
- User name:** An empty text input field.
- Password:** A password input field with masked characters (\*\*\*\*\*).
- Password confirmation:** A password input field with masked characters (\*\*\*\*\*).
- Path:** A text input field containing the default path `/core_<host>_<app>.gz`.

At the bottom of the configuration area are 'OK' and 'Cancel' buttons.

For a description of the parameters on the **Core Dump** tab, refer to the description of the **System settings** page of the OMM Web service. The same parameters are described in the **Core dump URL** section (section 5.4.1.12).

### 6.5.2.9 Remote system dump

A system dump is a file that holds information about the OpenMobility Manager and all connected RFPs. With the Remote System Dump feature, a system dump is transferred to a remote server. You can configure a specific destination, otherwise the system configuration URL is used.

The system dump is generated manually by pressing the dump button or automatically at the configured time. Please ensure that the used fileserver allows writing or creating system dumps.

The screenshot displays the 'Remote system dump' configuration interface. At the top, there are several tabs: 'Net parameters', 'DECT phones', 'DECT phones firmware', 'IMA', 'Additional services', 'User monitoring', and 'Special branding'. Below these are sub-tabs: 'Core dump', 'Remote system dump' (highlighted in blue), 'OMM certificate', 'OMM certificate server', 'SNMP', and 'Time zones'. The main configuration area is titled 'Daily automatic remote system dump' and contains an 'Active' checkbox (unchecked) and a 'Time of day' field set to '0 : 0'. Below this is a 'URL' section with the following fields and options:

- 'Configure specific destination' checkbox (unchecked)
- 'Protocol' dropdown menu set to 'TFTP' (with a blue checkmark)
- 'Port' text input field and 'Use default port' checkbox (checked)
- 'Server' text input field
- 'User name' text input field
- 'Password' text input field (masked with dots)
- 'Password confirmation' text input field (masked with dots)
- 'Path' text input field
- 'Use common certificate configuration' checkbox (unchecked)

At the bottom of the form are three buttons: 'OK', 'Cancel', and 'Dump' (highlighted in blue).

For a description of the parameters on the **Remote system Dump** tab, refer to the description of the **System settings** page of the OMM Web service. The same parameters are described in the **System dump** section (section 5.4.1.11).

### 6.5.2.10 OMM Certificate

You can overwrite the hard-coded OMM certificate by importing a local certificate chain and a private key file which may be password-protected. The OMM certificate will be used for incoming AXI and HTTPS connections to the OMM services. If the OMM can be reached from the internet by a domain and an appropriate CA certificate has been imported, no security warnings are displayed in web browsers that trust the CA root certificate.

For more information on this feature, see section 7.10.

### Certificates/key

- **Private key:** Indicates whether the OMM has a private key file (read-only).
- **Local certificate chain:** Indicates the number of local certificate chains deployed on the OMM (read-only).
- **Delete certificates/key:** Allows you to delete any existing certificate or key files.

### PEM file import

- **Import PEM file with:** Indicates the content type of the PEM file being imported. Available options are “Local certificate chain” or “Private key”.
- **File:** Specifies the location of the PEM file to be imported.
- **Import:** Triggers the import of the specified PEM file.

### Private key password

- **Private key password:** Specifies the password to be used for the private key file, if you want the file to be password-protected.
- **Password confirmation:** Confirms the password for the private key file.



### 6.5.2.11 OMM certificate server

OMM certificates can be updated automatically through configuration of a secure OMM certificate server URL.

- **Active:** Enables the feature.
- **Protocol:** Specifies the preferred protocol (FTP, TFTP, FTPS, HTTP, HTTPS, SFTP).
- **Server:** Specifies the name or IP address of the external file server.
- **Port:** Specifies the certificate server's port number
- **Use default port:** If selected, the default port associated with the selected protocol is used.
- **User name:** Specifies the user name to authenticate against the external file server.
- **Password:** Specifies the password to authenticate against the external file server.
- **Password confirmation:** Confirms the password to authenticate against the external file server.
- **Path without filename:** Specifies the path on the file server to the certificate files.
- **Use common certificate configuration:** Enables the use of the system-wide certificate validation settings, as configured under the **System** -> **Provisioning** menu (see section 6.5.5).
- **Local certificate file:** Specifies the name of the PEM file on the external server including the local certificate or a certificate chain.
- **Private key file:** Specifies the name of the PEM file on the external server including the local key.

### 6.5.2.12 SNMP

To manage a larger RFP network, an SNMP agent is provided for each RFP. The SNMP agent provides alarm information and allows an SNMP management system (such as “HP Open View”) to manage this network. The SNMP sub menu of the OMM provides configuration of SNMP service settings.

For a description of the parameters on the **SNMP** tab, refer to the description of the **SNMP** menu of the OMM Web service (see section 5.4.6).

### 6.5.2.13 Time zones

The OMM provides all available time zones on the **Time zones** tab. They are set with their known daylight savings time rules adjusted to the Universal Coordinated Time (UTC) by default. The difference to the UTC time is shown in the **UTC difference** field.

In addition, you can configure a new (free) time zone.

The date and time are provided by the OMM to the Mitel 142d and Mitel 600 DECT phones if the DECT phone initiates a DECT location registration. The DECT phone initiates a DECT location registration when:

- subscribing to the OMM
- entering the network again after the DECT signal was lost
- at power on
- silent charging feature is active at the phone and the phone is taken out of the charger
- after a specific time to update date and time

You can change the time zone rules for up to five time zones. The changes are saved in the configuration file and are restored after each OpenMobility Manager startup.

Net parameters | DECT phones | DECT phones firmware | IMA | Additional services | User monitoring | Special branding

Core dump | Remote system dump | OMM certificate | OMM certificate server | SNMP | **Time zones**

Name: Eastern (EST UTC-5 DST)

ID: EST

General | Standard time | Daylight savings time

Difference local standard time to UTC:  min

Daylight savings time:

Difference daylight savings time to standard time:  min

### General

- **Difference local standard time to UTC:** The difference (in minutes) between the local standard time and UTC time.
- **Daylight savings time:** Enables or disables application of Daylight Savings Time (DST) for the time zone. If disabled, the Standard time and Daylight savings time tabs are not accessible.
- **Difference daylight savings time to standard time:** The difference (in minutes) between Daylight Savings Time (DST) and Standard Time for the time zone.

If the **Daylight savings time** parameter on the **General** tab is enabled, you can change the standard time and the daylight savings time (DST) of a time zone in the **Standard time** and **Daylight savings time** tabs. If the time zone has no DST, only the UTC difference can be configured. For the DST both points of time (begin of standard time and begin of daylight savings time) must be specified exactly. Therefore a certain day in the month or a certain week day in a month can be used.

The following commands are available to edit time zones:

- **OK:** Confirm the changed time zone settings.
- **Cancel:** Cancels the operation and resets the changed time zone back to the default setting.
- **Default:** Resets **all** individual time zone settings to the default values and deletes the changed time zone rules in the configuration file.

### 6.5.3 “STATISTICS” MENU (MONITORING MODE ONLY)

The **Statistics** page provides system statistics counters which can be used to check system behavior. The page is only available in **Monitor Mode**.

The screenshot displays the 'Statistics' menu on the left side of the interface, listing various system components like Monitoring, Status, System, SIP, Provisioning, etc. The main area shows a table of statistics counters with columns for Counter, Total, Average, Minimum, and Maximum. The 'CC:Transaction Establish' counter is highlighted with a total value of 30. Below the table, a detailed panel for 'CC:Transaction Establish' is shown, featuring a bar chart, a table with 'From', 'To', and 'Number' columns, and buttons for 'Refresh', 'Clear', and 'Cancel'. The bar chart shows a single peak at 149 hours. The table below the chart lists 20 entries, all with a 'Number' of 0.

Counter	Total	Average	Minimum	Maximum
DLC:Abnormal air con...	0	-	-	-
CC :Transaction Estab...	30	-	-	-
CC :PP Not Found	3	-	-	-
CC :Paging for PP	32	-	-	-
CC :Release from PP	17	-	-	-
CC :Setup rejected	0	-	-	-
MM :PP Location regis...	199	-	-	-
MM :PP Detach	0	-	-	-
MM :PP Subscription	0	-	-	-
MM :PP Subscription f...	0	-	-	-
DLC:PP Connection H...	0	-	-	-
SS :Transaction Estab...	4	-	-	-
COMS:Transaction Es...	0	-	-	-
SS :Facility received	24	-	-	-
SS :Facility transmitted	60	-	-	-
LCE:Link to PP establi...	29	-	-	-
LCE:Link from PP esta...	211	-	-	-
IMA:AXI request count	1456	-	-	-

From	To	Number
25.01.1...	25.01.1...	0
25.01.1...	25.01.1...	0
25.01.1...	25.01.1...	0
25.01.1...	25.01.1...	0
25.01.1...	25.01.1...	0
25.01.1...	25.01.1...	0
25.01.0...	25.01.0...	0
25.01.0...	25.01.0...	0
25.01.0...	25.01.0...	0
25.01.0...	25.01.0...	0
25.01.0...	25.01.0...	0
25.01.0...	25.01.0...	0
25.01.0...	25.01.0...	0
25.01.0...	25.01.0...	0
25.01.0...	25.01.0...	0
25.01.0...	25.01.0...	0
25.01.0...	25.01.0...	0
25.01.0...	25.01.0...	0
25.01.0...	25.01.0...	0
25.01.0...	25.01.0...	0
25.01.0...	25.01.0...	0
25.01.0...	25.01.0...	0
25.01.0...	25.01.0...	0

Statistic counters beginning with “+” are counters that are taken over by the standby OMM in case of a failover. All other counters are reset to default values in case of a failover. For more details about the standby feature, see section 7.15.

You can:

- **Refresh all:** request OMM update for all statistics counters.
- **Clear all:** reset all statistics counters in OMM.

If a statistics counter is selected in the table, it is shown in a detail panel. This detail panel provides all available information for this statistics counter. You can:

- update this single statistics counter by pressing the **Refresh** button, or
- reset this single statistics counter by pressing the **Clear** button.

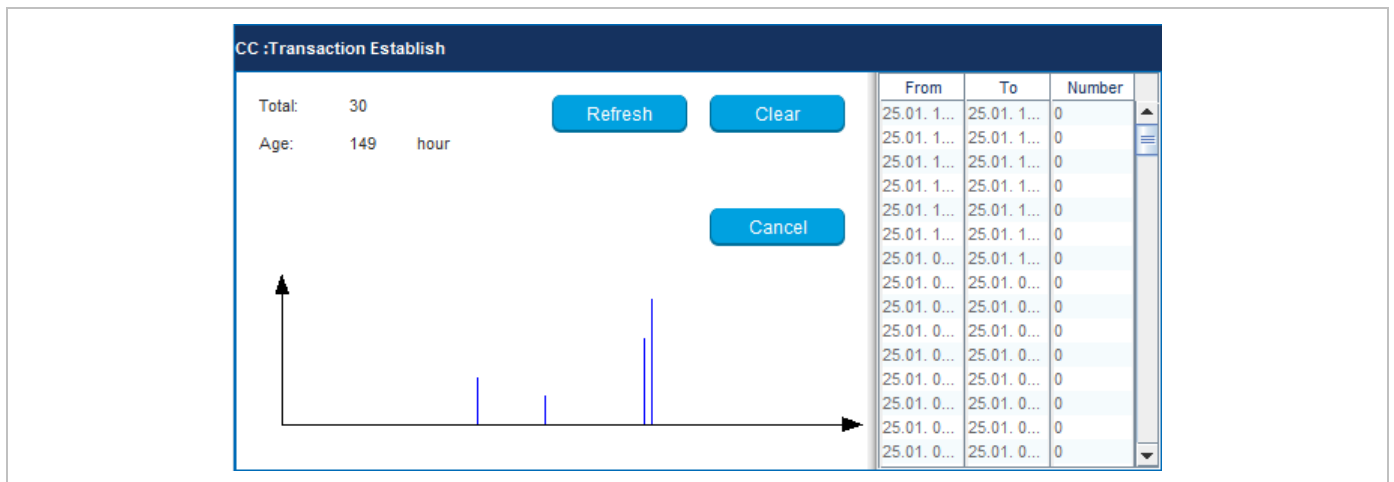

## 6.5.4 “SIP” MENU

The **SIP** menu covers global settings for SIP signaling and RTP voice streams and contains the following tabs:

- Basic settings (see section 6.5.4.1)
- Advanced settings (see section 6.5.4.2)
- Registration traffic shaping (see section 6.5.4.3)
- Backup settings (see section 6.5.4.4)
- RTP settings (see section 6.5.4.5)
- DTMF settings (see section 6.5.4.6)
- Intercom Push-to-talk (see section 6.5.4.7)
- Supplementary services (see section 6.5.4.8)
- Conference (see section 6.5.4.9)
- Security (see section 6.5.4.10)
- Certificate server (see section 6.5.4.11)

### 6.5.4.1 Basic settings

For a description of the parameters on the **Basic settings** tab, see the description of the **System -> SIP** menu of the OMM Web service. The same parameters are described in the **Basic settings** section (section 5.4.3.1).

In addition, the following parameters (related to SIP multiport support) are available on the **Basic settings** tab:

#### Local port range

- **DECT phone user UDP/TCP:** The port range to be used for DECT users when UDP/TCP is used as the transport protocol. The default is 5060 – 5060.
- **DECT phone user TLS:** The port range to be used for DECT users when TLS is used as the transport protocol. The default is 5061 – 5061.
- **Conference room UDP/TCP:** The port range to be used for Conference Rooms when UDP/TCP is used as the transport protocol. The default is 4060 – 4060.
- **Conference room TLS:** The port range to be used for DECT users when TLS is used as the transport protocol. The default is 4061 – 4061.

**Note:** There are certain rules to note when configuring port ranges; see section 3.17 for more information.

### 6.5.4.2 Advanced settings

You can set several additional SIP parameters on the **Advanced settings** tab.

The screenshot displays the 'Advanced settings' tab for SIP parameters. The interface is organized into several sections:

- General:**
  - Explicit MWI subscription:
  - X-Aastra-Id info:
  - Dial terminator:
  - Registration failed retry timer:  sec
  - Registration timeout retry timer:  sec
  - Determine remote party by: P-Asserted-Identity (dropdown)
  - Call reject state code (user reject):
  - Session timer:  sec
  - SIP contact matching: URL (dropdown)
  - User agent info:
  - User agent info - compatibility mode:
  - Multiple 180 Ringing:
  - Transaction timer:  msec
  - Blacklist time out:  min
  - Call reject state code (device unreachable):
  - Incoming call timeout:  sec
- Semi-attended transfer:**
  - Transfer mode: Attended (dropdown)
  - Refer-to with replaces:

At the bottom of the form are two buttons: 'OK' and 'Cancel'.

For a description of the parameters on the **Advanced settings** tab, refer to the description of the **System -> SIP** menu of the OMM Web service. The same parameters are described in the **Advanced settings** section (section 5.4.3.2).

In addition, the following parameters are available in the OMP only:

- **X-Aastra-Id info:** Enable or disable inclusion of the private X-Aastra-Id header in each SIP REGISTER message.
- **User agent info – compatibility mode:** If the **User agent info** option is enabled, the OMM sends information on his version inside the SIP User-Agent/Server headers; this parameter ensures backward compatibility with version information used in older SIP-DECT software releases.

### 6.5.4.3 Registration traffic shaping

Registration traffic shaping parameters allow you to limit the number of simultaneous SIP registrations at startup/fail over of the OMM. This feature is always activated because disabling it may overload the OMM or the call server.

For a description of the parameters on the **Registration traffic shaping** tab, see the description of the **System -> SIP** page of the OMM Web service. The same parameters are described in the **Registration traffic shaping** section (section 5.4.3.5).

#### 6.5.4.4 Backup settings

To increase the operational availability of the system in critical environments like hospitals, the OMM offers a failover redundancy mechanism for the SIP server. In addition to the primary proxy, outbound proxy and registrar server, you can configure two additional levels of backup servers (secondary and tertiary servers).

The OMM failover behavior in detail depends on the backup server settings set here. A full description of the behavior and deployment hints can be found in section 7.20.3.

- **Secondary proxy server / port, Secondary registrar server / port, Secondary outbound server / port:** Enter the parameters for the secondary server in these fields.



- **Tertiary proxy server / port, Tertiary registrar server / port, Tertiary outbound server / port:**  
Enter the parameters for the tertiary server in these fields.

**Note:** Server addresses can be configured as IP addresses, names or a fully qualified domain names. It is possible to configure a mixture of IP addresses, names or fully qualified domain names for the different servers. If fully qualified domain names are configured and the respective port setting is configured to zero ("0"), DNS SRV queries will be performed to locate a list of servers in the domain (see 0).

- **Failover keep alive:** The keep-alive mechanism allows transferring all users registered on a failed server (failover) to secondary/tertiary servers as well as automatically switching back to primary servers. Otherwise, failover is executed only single users. Enable this option if you want to use this feature (default: off).
- **Failover keep alive time:** For each registration target, a user could be registered successful with, a keep alive procedure is started. Enter the time in this field after which a new keep-alive procedure must be started (1-60 minutes, default 10 min.).

For a detailed description of the keep-alive mechanism see section 7.20.4.

### 6.5.4.5 RTP settings

For a description of the parameters on the **RTP settings** tab, see the description of the **System -> SIP** page of the OMM Web service. The same parameters are described in the **RTP settings** section (section 5.4.3.3).

The screenshot displays the 'RTP settings' configuration page. At the top, there are several tabs: 'Intercom/Push-to-talk', 'Supplementary services', 'Conference', 'Security', and 'Certificate server'. Below these, there are sub-tabs: 'Basic settings', 'Advanced settings', 'Registration traffic shaping', 'Backup settings', 'RTP settings' (which is active), and 'DTMF settings'. The main content area contains the following settings:

- RTP port base:** A text input field containing the value '16320'.
- Preferred codec 1:** A dropdown menu with 'G.711-u-law' selected.
- Preferred codec 2:** A dropdown menu with 'G.711-A-law' selected.
- Preferred codec 3:** A dropdown menu with 'G.729-A' selected.
- Preferred codec 4:** A dropdown menu with 'G.722' selected.
- Preferred packet time:** A dropdown menu with '10' selected, followed by a unit selector set to 'msec'.
- Silence suppression:** An unchecked checkbox.
- Receiver precedence on codec negotiation:** An unchecked checkbox.
- Eliminate comfort noise packets:** An unchecked checkbox.
- Single codec reply in SDP:** An unchecked checkbox.

At the bottom of the form, there are two buttons: 'OK' and 'Cancel'.

### 6.5.4.6 DTMF settings

For a description of the parameters on the **DTMF settings** tab, see the description of the **System -> SIP** page of the OMM Web service. The same parameters are described in the **DTMF settings** section (section 5.4.3.4).

### 6.5.4.7 Intercom Push-to-talk

You can set global auto-answer settings on the **Intercom Push-to-talk** tab. For more information on this feature, see section 3.31.

### Incoming calls

- **Auto answer:** Enables or disables auto-answer on incoming calls.
- **Microphone mute:** Enables or disables microphone muting when incoming calls are automatically answered.
- **Warning tone:** Enables or disables warning tone on incoming call. A short ringtone is played if there are no active calls. If there is an active call in a “barge in” situation, the ringing will be in-band
- **Allow barge in:** Allows/disallows “barge-in” on existing calls.

### Outgoing calls

- **Initialization prefix for push-to-talk:** String to be entered when initiating an intercom call. An empty string indicates that the DECT phone cannot initiate an intercom call.

### 6.5.4.8 Supplementary services

For a description of the parameters on the **Supplementary services** tab, see the description of the **System -> SIP** page of the OMM Web service. The same parameters are described in the **Supplementary Services** section (section 5.4.3.6).

The screenshot shows the 'Supplementary services' configuration page in the OMM Web service. The page has a tabbed interface with the following tabs: Basic settings, Advanced settings, Registration traffic shaping, Backup settings, RTP settings, and DTMF settings. The 'Supplementary services' tab is active, and it contains several sub-sections: Intercom/Push-to-talk, Supplementary services, Conference, Security, and Certificate server. The 'Supplementary services' sub-section is expanded and shows the following settings:

Setting	Value	Notes
Call forwarding / diversion	<input checked="" type="checkbox"/>	
Local line handling	<input checked="" type="checkbox"/>	When switched off, all R key events (Hook flash) in a call active state will be sent via SIP INFO as DTMF.
Call transfer by hook (A142d)	<input type="checkbox"/>	
Call transfer by hook (6xxd)	<input checked="" type="checkbox"/>	
Truncate Caller identification after *,	<input type="checkbox"/>	
SIP reRegister after 2 active OMM failover	<input type="checkbox"/>	
Ringback on hold	<input checked="" type="checkbox"/>	
Call release timeout	5 sec	
Hold call release timeout	5 sec	
Failed call release timeout	5 sec	

At the bottom of the page, there are two buttons: 'OK' and 'Cancel'.

### 6.5.4.9 Conference

You can define the conference mode globally for all SIP-DECT users on the **Conference** tab. For more information on the Conferencing feature, see section 0.

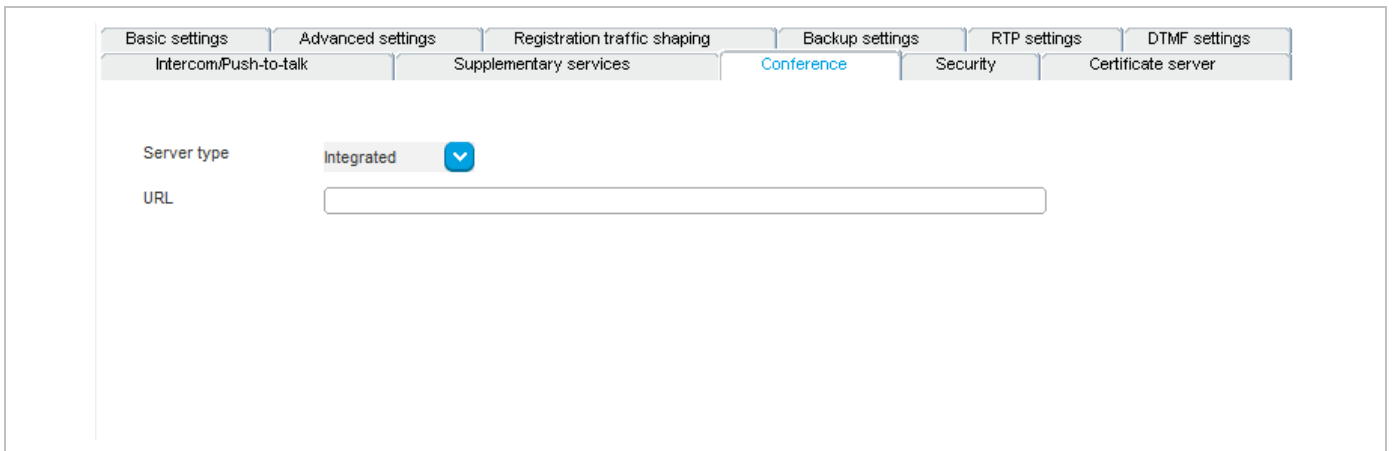

The screenshot shows a web interface for configuring SIP-DECT settings. At the top, there are several tabs: 'Basic settings', 'Advanced settings', 'Registration traffic shaping', 'Backup settings', 'RTP settings', and 'DTMF settings'. Below these, there are sub-tabs: 'Intercom/Push-to-talk', 'Supplementary services', 'Conference' (which is highlighted in blue), 'Security', and 'Certificate server'. The 'Conference' tab is active, showing two configuration fields: 'Server type' with a dropdown menu currently set to 'Integrated' (indicated by a blue checkmark), and 'URL' with an empty text input field.

- **Server type:** Specifies the operational mode for the conference server. Available options are:
  - **None:** neither external nor internal conference server is used.
  - **Integrated:** the conference server integrated in the SIP-DECT system is used.
  - **External:** an external conference server (e.g., Broadsoft) is used.
  - **External – Blind Transfer:** an external conference server is used (e.g. MiVoice Business). The initiation of the conference is signaled as a blind transfer to the destination specified in the URL parameter.
- **URL:** Specifies the URL for the conference server.

### 6.5.4.10 Security

For a description of the parameters on the **Security** tab, see the description of the **System -> SIP** page of the OMM Web service. The same parameters are described in the **Security** section (section 5.4.3.8) and the **Manual Import** section (section 5.4.3.10).

Basic settings	Advanced settings	Registration traffic shaping	Backup settings	RTP settings	DTMF settings
Intercom/Push-to-talk	Supplementary services	Conference	Security	Certificate server	
<b>General</b>					
Persistent TLS keep alive timer active <input type="checkbox"/>		Persistent TLS keep alive timer timeout		30 sec	
TLS authentication <input type="checkbox"/>		TLS common name validation		<input type="checkbox"/>	
Send SIPs over TLS active <input type="checkbox"/>					
Private key password		*****			
Password confirmation		*****			
OK		Cancel			
<b>Certificates/key</b>					
Trusted certificate(s)		1		Private key <span style="color: green;">✔</span>	
Local certificate chain		1		<a href="#">Delete certificates/key</a>	
<b>PEM file import</b>					
Import PEM file with		Trusted certificate <input checked="" type="checkbox"/>			
<a href="#">File</a>		<input type="text"/>			
		<a href="#">Import</a>			

### 6.5.4.11 Certificate server

For a description of the parameters on the **Certificate server** tab, see the description of the **System -> SIP** page of the OMM Web service. The same parameters are described in the **Certificate server** section (section 5.4.3.9).

Basic settings	Advanced settings	Registration traffic shaping	Backup settings	RTP settings	DTMF settings
Intercom/Push-to-talk	Supplementary services	Conference	Security	Certificate server	
<b>Active</b>					
Active		<input type="checkbox"/>			
Protocol		HTTPS <input checked="" type="checkbox"/>			
Server		<input type="text"/>			
Port		<input type="text"/>		Use default port <input checked="" type="checkbox"/>	
User name		<input type="text"/>			
Password		<input type="text"/>			
Password confirmation		<input type="text"/>			
Path without file name		<input type="text"/>			
Trusted certificates file		<input type="text"/>			
Local certificate chain file		<input type="text"/>			
Private key file		<input type="text"/>			
OK		Cancel			

## 6.5.5 "PROVISIONING" MENU

SIP-DECT supports provisioning through external configuration files. With SIP-DECT 6.0 or later, you can configure a URL for an external file server, from which all configuration files can be downloaded. The configured provisioning server URL is used for secure connections to the file server to retrieve configuration or firmware files.

The **Provisioning** menu contains settings related to the provisioning server and contains the following tabs:

- Provisioning (see section 6.5.5.1)
- Provisioning certificate (see section 6.5.5.2)
- Certificate server (see section 6.5.5.3)
- System credentials (see section 6.5.5.4)

### 6.5.5.1 Provisioning

The screenshot shows the Provisioning configuration window with the following settings:

- Configuration files URL:**
  - Active:
  - Protocol: HTTPS
  - Port:
  - Server:
  - Path:  /ipdect.cfg, /<MAC>.cfg, /<PARK>.cfg ...
- SSL settings:**
  - Validate certificates:
  - Validate expires:
  - Validate host name:
  - Allow unconfigured trusted certificates:
  - Import certificates with first connection:
  - SSL version: Auto
- Daily automatic reload of configuration and firmware files:**
  - Active:
  - Time of day: 00 : 00

#### Configuration files URL

- **Active:** Enable the configuration file URL feature.
- **Protocol:** The protocol to be used to fetch the configuration files.
- **Port:** Provisioning server's port number.
- **Use default port:** If selected, the default port associated with the selected protocol is used.
- **Server:** IP address or name of the provisioning server.
- **Path:** Path to the configuration and resource files on the provisioning server.

### SSL settings

- **Validate certificates:** Enables or disables certificate validation. If enabled, the server certificate is validated against trusted CA's (signed by a CA from the Mozilla CA certificate list) and the configured trusted certificates.
- **Validate expires:** Enables or disables the validation of certificate expiry. When this parameter is enabled, the client verifies whether or not a certificate has expired prior to accepting the certificate.
- **Validate host name:** Enables or disables the validation of hostnames on the OMM.
- **Allow unconfigured trusted certificates:** If enabled, this parameter disables any server certificate validation as long as no trusted certificate was imported into the OMM. AXI commands in a received configuration file may import such trusted certificates into the OMM.
- **Import certificates with first connection:** If enabled (in conjunction with the **Allow unconfigured trusted certificates** parameter), the trusted certificate will be imported from the cert chain delivered in the server response without any validation, as long as no trusted certificate was imported previously into the OMM.
- **SSL version:** The SSL protocol version to use for the configuration file server connection. Available options are: TLS1.0, TLS1.1, TLS1.2 or AUTO, where AUTO accepts all protocol versions.

### Daily automatic reload of configuration and firmware files

- **Active:** Enables automatic reload of the configuration and resource files on a daily basis, at the specified time.
- **Time of day:** Time for scheduled reload of configuration and firmware files.

### 6.5.5.2 Provisioning certificates

Provisioning certificates are used for secure connections to configuration or firmware file servers that support mutual authentication.

A trusted certificate chain is used by the OMM to validate the server. This is required if the server has no certificate derived from a trusted CA root certificate, where the OMM uses the Mozilla CA Certificate List. If no server certificate is available, the validation against trusted and CA certificates can be disabled in the certificate validation options (only encrypted TLS connection).

The local certificate chain plus the private key are provided from the OMM to servers requesting mutual authentication. The private key file may be password protected.

Provisioning | Provisioning certificates | Certificate server | System credentials

**Certificates/key**

Trusted certificate(s) 0 Private key X

Local certificate chain 0 Delete certificates/key

**PEM file import**

Import PEM file with Trusted certificate

File

Import

**Private key password**

Private key password

Password confirmation

OK Cancel

### 6.5.5.3 Certificate server

The provisioning certificates can be updated automatically through configuration of a secure provisioning certificate server URL.

Provisioning | Provisioning certificates | Certificate server | System credentials

Active

Protocol HTTPS

Server

Port  Use default port

User name

Password

Password confirmation

Path without file name

Use common certificate configuration

Trusted certificates file

Local certificate chain file

Private key file

OK Cancel

- **Active:** Enable automatic updating of certificates the feature.
- **Protocol:** Specifies the preferred protocol (FTP, TFTP, FTPS, HTTP, HTTPS, SFTP)
- **Server:** Specifies the name or IP address of the external file server.



- **Port:** Specifies the certificate server's port number
- **Use default port:** If selected, the default port associated with the selected protocol is used.
- **User name:** Specifies the user name to authenticate against the external file server.
- **Password:** Specifies the password to authenticate against the external file server.
- **Password confirmation:** Confirms the password to authenticate against the external file server.
- **Path without filename:** Specifies the path on the file server to the certificate files.
- **Use common certificate configuration:** Enables the use of the system-wide certificate validation settings, as configured on the **System -> Provisioning -> Provisioning certificates** page (see section 6.5.5.2)
- **Trusted certificate file:** Specifies the name of the PEM file on the specified server, including the trusted certificates.
- **Local certificate file:** Specifies the name of the PEM file on the external server including the local certificate or a certificate chain.
- **Private key file:** Specifies the name of the PEM file on the external server including the local key.

#### 6.5.5.4 System credentials

System credentials are used to retrieve configuration and resource files from the configured provisioning server for protocols supporting authentication or servers requesting authentication. For HTTP/HTTPS, basic and digest authentication are supported.

The screenshot shows a web-based configuration interface. At the top, there are four tabs: 'Provisioning', 'Provisioning certificates', 'Certificate server', and 'System credentials'. The 'System credentials' tab is active. Below the tabs, there is a form titled 'System credentials' with three input fields: 'User name' (containing 'Testdoc'), 'Password' (masked with '\*\*\*\*'), and 'Password confirmation' (masked with '\*\*\*\*'). At the bottom of the form are two buttons: 'OK' and 'Cancel'.

- **User name:** Specifies the user name for authentication against the provisioning server.
- **Password:** Specifies the password for authentication against the provisioning server
- **Password confirmation:** Confirms the password for authentication against the provisioning server.

### 6.5.6 “USER ADMINISTRATION” MENU

In the **User administration** menu you configure the OMM user accounts.

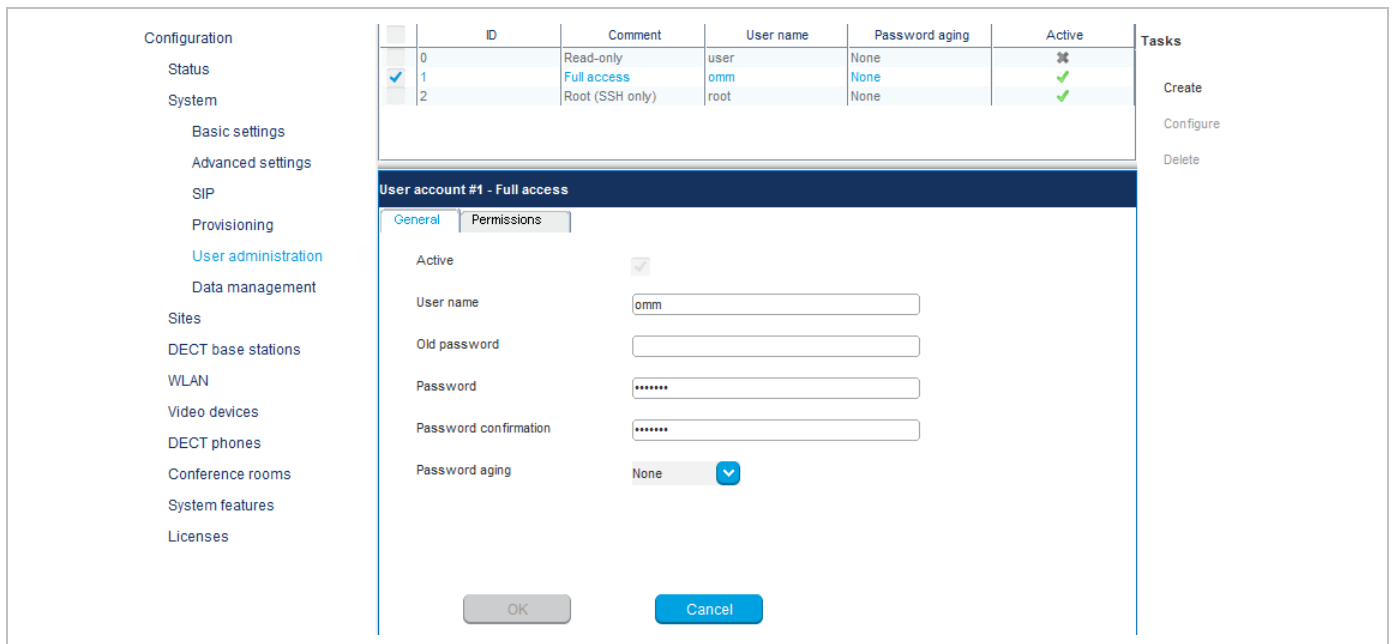

The three user accounts “Full access”, “Read-only” and “Root (ssh only)” available via the **User administration** page of the OMM Web service can also be configured in the OMP. These three predefined user accounts cannot be removed or renamed. Only the “Read-only” account can be activated and deactivated. The permissions are fixed. This is consistent with the OMM WEB service. The meaning of the different account types is described in section 7.17.1. In addition, the OMP allows to create additional user accounts (login and password) and to assign specific permissions.

The tasks which can be performed are mode-dependant.

Configuration mode	Monitor mode	See section
<b>Create:</b> create new user account		6.5.6.1
<b>Configure:</b> configure selected user account in detail panel		6.5.6.2
	<b>Show details:</b> shows selected user account in detail panel	6.5.6.3
<b>Delete:</b> delete selected user account		6.5.6.4

### 6.5.6.1 Creating New User Accounts

It is possible to create additional user accounts (login and password) and to assign specific permissions. These accounts are mainly designed to have specific login data and permissions for applications which are using OM AXI to connect with the OMM.

**Note:** Individual user accounts cannot be used for a login to the OMM Web service nor SSH.

ID	Comment	User name	Password aging	Active
0	Read-only	user	None	✘
1	Full access	omm	None	✔
2	Root (SSH only)	root	None	✔

Adding individual user accounts is only possible in **Configuration Mode**. To add a user account, do the following:

1 In the **Tasks** bar click on the **Create** command.

The **New user account** panel opens. It provides various tabs where the account data must be entered.

2 Configure the user account, see parameter description below.

3 Press the **OK** button.

The following parameters can be set in the tabs of the **New user account** panel:

#### General

For a description of the parameters which can be set in the **General** tab, see the description of the **User administration** page of the OMM Web service (see section 6.5.6.).

#### Permissions

The permissions for an individual user account can be set independent from any license status even if some of the permissions can only be used with an appropriate license.

If an application connects with the OMM via OM AXI, then the permissions been sent from the OMM to the application is the result of the configured permissions for this account and the actual license status. For more information please see the OM Application XML Interface (OM AXI) specification /31/.

The permissions have the following meaning:

Permission	Description
Read	Read OMM data (OM AXI get requests)
Write	Set OMM data (OM AXI set requests)
Messaging info	Sent messages with priority "Info"
Messaging	Sent messages with priority "Low", "Normal" and "High"
Messaging emergency	Sent messages with priority "Emergency"
Messaging locating	Sent messages with priority "LocatingAlert"
Locating	Permission to query the position of DECT phones and to track DECT phone positions
Monitoring	Permission to monitor various technical aspects of the mobility system
Video	Permission for video streaming

### 6.5.6.2 Changing a User Account

Changing user accounts is only possible in **configuration mode**. To change the configuration of an existing user account, do the following:

- 1 Select the appropriate user account in the account table.
- 2 In the **Tasks** bar click on the **Configure** command.
- 3 Change the user account parameters (see parameter descriptions in section 6.5.6.1).
- 4 Press the **OK** button.

**Please note:** The predefined user accounts "Full access", "Read-only" and "Root (ssh only)" user accounts cannot be renamed. Also their permissions are fixed and cannot be changed.

### 6.5.6.3 Viewing User Account Details

You can view the configuration of a user account in **monitor mode**. Proceed as follows:

- 1 Select the appropriate user account in the table.
- 2 In the **Tasks** bar click on the **Show details** command.  
The user account data is displayed in the user account detail panel.
- 3 To close the user account detail panel, click the **Cancel** button.

### 6.5.6.4 Deleting User Accounts

Deleting user accounts is only possible in **configuration mode**. To delete one or more existing user accounts proceed as follows:

- 1 Select the appropriate account(s) in the user account table by activating the corresponding checkbox(es).
- 2 In the **Tasks** bar click on the **Delete** command.
- 3 Confirm the displayed prompt with **OK**.

**Please note:** The predefined user accounts “Full access”, “Read-only” and “Root (ssh only)” user accounts cannot be removed.

## 6.5.7 “DATA MANAGEMENT” MENU

The **Data management** menu provides access to data related to import and export features.

The menu provides the settings in several tabs:

- **Auto DB export** (see section 6.5.7.1)
- **User data import** (see section 6.5.7.2)
- **DECT phones synchronization** (see section 6.5.7.3)
- **Manual DB import** (see section 6.5.7.4)
- **Manual DB export** (see section 6.5.7.5)
- **Maintenance** (see section 6.5.7.6)
- **IMA** (see section 6.5.7.7)

### 6.5.7.1 Automatic DB export

The automatic database export feature allows an automatic database backup to an external server for each configuration modification.

**Please note:** Synchronization with an NTP server is mandatory for an automatic database export. For NTP server configuration, see section 7.5.4 and section 7.6.

The screenshot displays the configuration page for 'Auto DB export'. The sidebar on the left lists various configuration categories, with 'Data management' selected. The main configuration area includes the following fields and controls:

- Active:** A checkbox that is currently unchecked.
- Protocol:** A dropdown menu set to 'None'.
- Port:** An input field with a 'Use default port' checkbox checked.
- Server:** An input field.
- User name:** An input field.
- Password:** A password input field.
- Password confirmation:** A password confirmation input field.
- Path:** An input field containing the value '/150615\_Customer\_1F102643C7\_omm\_conf.gz'.
- Use common certificate configuration:** A checkbox that is currently unchecked.

At the bottom of the configuration area, there are 'OK' and 'Cancel' buttons.

For a description of the parameters on the **Automatic DB export** tab, see the description of the **System** -> **Data management** page of the OMM Web service. The same parameters are described in the **Automatic Database Export** section (section 5.4.7.3).

### 6.5.7.2 User data import

The user data import feature allows the import of user data from an external provisioning server.

- **Configure specific source:** Enables the specific URL to an external file server for retrieving the user data file.
- **Protocol:** Specifies the preferred protocol.
- **Port:** Specifies the port on the server.
- **Server:** Specifies the IP address or the name of the server.
- **User name, Password, Password confirmation:** Specifies the credentials for the server.
- **Path:** Specifies the path to the file containing the user data.
- **Use common certificate configuration:** Enables the use of the system-wide certificate validation settings, as configured on the **System -> Provisioning -> Certificates** page (see section 5.4.2.5).

For further information on the user data import, see the *OM DECT Phone Sharing and Provisioning Guide*.

### 6.5.7.3 DECT phones synchronization

The user data synchronization feature ensures that all user and device database information is distributed to all OMM instances in the system. Each peripheral OMM must have a connection to the AXI interface of the central OMM (and the standby central OMM, if configured) to send and receive updated user data information. Specify the same user credentials used to access the central OMM via the OMP. For more information on this feature, see section 7.16.

- **Activate synchronization:** Enable user data synchronization for the OMM.
- **OMM1:** Specifies the IP address of the central OMM.
- **OMM2:** Specifies the IP address of a second central OMM, in the case of a standby configuration.
- **User name:** Specifies the user name required to access the central OMM.
- **Password:** Specifies the password required to access the central OMM.
- **Password confirmation:** Confirms the password required to access the central OMM.

#### 6.5.7.4 Manual DB import

The manual database import feature allows the import of an OMM database.

**Please note:** A manual import of a database results in a reset of the OMM.

For a description of the parameters on the **Manual DB import** tab, see the description of the **System -> Data management** page of the OMM Web service. The same parameters are described in the **Manual Database Import** section (section 5.4.7.1).

The screenshot shows the 'Manual DB import' configuration page. The left sidebar contains a navigation menu with 'Data management' selected. The main content area has several tabs: 'Auto DB export', 'User data import', 'DECT phones synchronization', 'Manual DB import' (active), 'Manual DB export', 'Maintenance', and 'IMA'. The configuration fields include:
 

- Protocol: FILE (dropdown menu)
- Port: [input field] Use default port (checkbox checked)
- Server: [input field]
- User name: [input field]
- Password: [input field]
- Password confirmation: [input field]
- Use common certificate: [checkbox unchecked]
- File selection: [File button] [input field]
- [Import button]

### 6.5.7.5 Manual DB export

The manual database export feature allows a manual database backup to an external server.

For a description of the parameters on the **Manual DB export** tab, see the description of the **System -> Data management** page of the OMM Web service. The same parameters are described in the **Manual Database Export** section (section 5.4.7.2).

The screenshot shows the 'Manual DB export' configuration page. The left sidebar contains a navigation menu with 'Data management' selected. The main content area has several tabs: 'Auto DB export', 'User data import', 'DECT phones synchronization', 'Manual DB import', 'Manual DB export' (active), 'Maintenance', and 'IMA'. The configuration fields include:
 

- Protocol: FILE (dropdown menu)
- Port: [input field] Use default port (checkbox checked)
- Server: [input field]
- User name: [input field]
- Password: [input field]
- Password confirmation: [input field]
- Use common certificate: [checkbox unchecked]
- Directory selection: [Directory button] [input field]
- File: 150615\_Customer\_1F102643C7\_omm\_conf.gz
- [Export button]



### 6.5.7.6 Maintenance

In the **Maintenance** panel, you can perform a system dump, for example, for product support information purposes. A file “sysdump.txt” is created in the selected directory. Click the **Directory** button to select the directory, then click the **Download** button to start the system dump.

The screenshot shows the OMP Maintenance panel. On the left is a navigation menu with categories like Configuration, Status, System, Sites, and Licenses. The main content area has tabs for various functions, with 'Maintenance' selected. Under the 'System dump' section, there is a 'Directory' button with a folder icon and a text input field, and a 'Download' button below it.

### 6.5.7.7 IMA

You can upload an IMA configuration file manually. To validate the existing configuration, the IMA configuration can be also downloaded. An uploaded IMA configuration may be overwritten if a server for the IMA configuration file is configured or if the ‘ima.cfg’ is available on the provisioning server. The IMA configuration can be deleted regardless of its source.

The screenshot shows the OMP IMA panel. The navigation menu is on the left. The main content area has tabs for various functions, with 'IMA' selected. There are three sections: 'Config file import' with a 'File' button and an 'Import' button; 'Config file export' with a 'Directory' button, a text input field, and an 'Export' button; and 'Delete config file' with a 'Delete' button. Below the export section, a file named '150615\_Customer\_1F102643C7\_ima.cfg' is listed.

- **Config file import**

To upload an IMA configuration file, click the **File** button to browse to the file, then click **Import**.

- **Config file export**

To download the current IMA configuration file, click the **Directory** button to select the destination directory, then click **Export**.

- **Delete config file**

To delete the IMA configuration file, click **Delete**.

### 6.5.8 “EVENT LOG” MENU

The **Event Log** menu provides information about system events. The menu is only available in **Monitor Mode**.

	Severity	Subsystem	Count	Time	Event	Tasks
Monitoring	0	STB*	1	2015/01/19 15:56:50.0...	2 OMM(s) on comman...	
Status	2	AXI	1	2015/01/19 15:57:33.0...	[193] New secure co...	
System	2	AXI	1	2015/01/19 15:57:33.1...	[193] Remote host clo...	Show details
Basic settings	3	IPL	1	2015/01/21 21:00:50.2...	RFP(0000) reconnected	Clear all
Advanced settings	3	IPL	1	2015/01/21 21:00:53.6...	RFP(0001) reconnected	
Statistics	0	STB*	1	2015/01/21 21:00:56.5...	Activating former stan...	
SIP	2	AXI	1	2015/01/21 21:00:56.5...	SIP-DECT 6.0RC4 Buil...	
Provisioning	2	AXI	1	2015/01/21 21:00:56.9...	[194] New connection...	
User administration	2	AXI	1	2015/01/21 21:00:57.6...	[198] New connection...	
Data management	2	AXI	1	2015/01/21 21:00:57.7...	[199] New connection...	
Event log	3	STB	1	2015/01/21 21:00:58.2...	No Connection to stan...	
Sites	2	AXI	1	2015/01/21 21:01:01.9...	[201] New connection...	
DECT base stations	2	AXI	1	2015/01/21 21:01:16.6...	[202] New secure co...	
WLAN	2	IPL	1	2015/01/21 21:01:19.3...	2 of 12 RFPs connected	
Video devices	2	AXI	1	2015/01/21 21:01:20.7...	[204] New connection...	
DECT phones	2	AXI	1	2015/01/21 21:01:22.4...	Broken Connection to ...	
Conference rooms	2	AXI	1	2015/01/21 21:29:05.4...	[203] New secure co...	
System features	3	DSIP	1	2015/01/21 21:36:26.7...	SIP registration to 10...	
Licenses	2	AXI	1	2015/01/21 22:28:44.8...	[203/omm] Remote ho...	
	2	AXI	1	2015/01/21 22:29:09.0...	[203] New secure co...	
	2	AXI	1	2015/01/21 22:29:09.6...	[203] Remote host clo...	
	2	AXI	1	2015/01/21 22:29:14.5...	[203] New secure co...	
	2	AXI	1	2015/01/21 22:34:26.0...	[203/omm] Remote ho...	
	2	AXI	1	2015/01/21 22:37:33.8...	[203] New secure co...	
	3	DSIP	2	2015/01/22 10:25:38.0...	SIP registration to 10...	
	3	AXI	1	2015/01/22 11:30:35.4...	[ 203] Disconnect clie...	
	2	AXI	1	2015/01/22 11:30:35.4...	[203/omm] Connection...	
	3	DSIP	1	2015/01/22 11:46:19.9...	SIP registration to 10...	
	2	AXI	1	2015/01/22 14:58:21.1...	[203] New secure co...	
	2	AXI	1	2015/01/22 15:19:26.9...	[202/omm] Remote ho...	
	2	AXI	1	2015/01/22 15:20:59.5...	[202] New secure co...	
	3	AXI	1	2015/01/22 17:38:20.4...	[ 203] Disconnect clie...	

#### 6.5.8.1 Event log detail panel

Event log

General

Severity

Subsystem

Count

Time

Event  
[199] New connection from 10.37.18.32:58185

## 6.6 “SITES” MENU

DECT base stations can be grouped into different sites. The **Sites** menu allows configuration and display of configured sites. An empty system has one predefined site (ID: 1) named “default”. The system requires a minimum of one site.

The screenshot shows the OMP interface with a sidebar on the left containing navigation options: Configuration, Status, System, Sites (highlighted), DECT base stations, WLAN, Video devices, DECT phones, Conference rooms, System features, and Licenses. The main area displays a table of sites:

ID	Name	Hi-Q audio	Enh. DECT sec...	SRTP	Terminal video	Number of RFPs
1	default	✘	✘	✓	✘	10
3	Real RFP	✘	✘	✓	✘	2

Below the table, the configuration for Site #3 is shown in the 'General' tab. The Name field contains 'Real RFP'. The Hi-Q audio technology, Enhanced DECT security, and Terminal video options are unchecked. The SRTP option is set to 'Preferred'. A blue information icon with the text 'Changing site parameters, may restart radio fixed parts in this site.' is visible. At the bottom, there are 'OK' and 'Cancel' buttons.

A site consists of the following parameters:

- **ID:** Identification number of the site. A value between 1 and 250 is possible. If no value is given, the OMM selects the next free ID.
- **Name:** The name of the site.
- **Hi-Q audio technology / Enhanced DECT security / Terminal video / SRTP:** These capabilities must be enabled or disabled specific for every site.
  - In sites, which are configured to provide this functionality, exclusively RFP 35/36/37 IP and RFP 43 WLAN are applicable.
  - In sites without this capability, it is allowed to mix these new RFP types with RFP 32/34 IP and RFP 42 WLAN.
- **Number of RFPs:** The number of RFPs which are assigned to this site.

The following tasks can be performed:

- **Create:** create a new site in the **General** tab.
- **Configure:** configure an existing site in the **General** tab.
- **Delete:** delete selected sites (only sites without assigned RFPs can be deleted).
- **Show details** (only in **Monitor Mode**): shows configuration of a selected site in the **General** tab.

## 6.7 “DECT BASE STATIONS” MENU

DECT base stations can be configured and viewed in the **DECT base stations** menu.

Configuration mode	Monitor mode	See section
Device list	Device list	6.7.1
Paging areas		6.7.2
Capturing		6.7.3
Enrolment		6.7.4
Export		6.7.5
	Sync view	6.7.6
	Statistics	6.7.7

### 6.7.1 “DEVICE LIST” MENU

The **Device list** panel displays all configured DECT base stations in a table. The device list is available in **Configuration Mode** and **Monitor Mode**.

Configuration	RFP ID	Name	MAC address	IP address	DECT cluster	Paging area	HW type	Conne...	Active	Tasks
Status	0x000	SVE RFP1	00:30:42:18:1D:...	10.37.18.31	1	0	RFP 35	✓	✓	
System	0x001	SVE RFP2	00:30:42:18:20:...	10.37.18.32	1	0	RFP 35	✓	✓	Create
Sites	0x002	simu	01:02:03:04:05:...	0.0.0.0	5	0	RFP 32	✗	✗	Configure
DECT base stations	0x003	simu	01:02:03:04:05:...	0.0.0.0	5	0	RFP 32	✗	✗	Delete
Device list	0x004	simu	01:02:03:04:05:...	0.0.0.0	5	0	RFP 32	✗	✗	✗ Filter
Paging areas	0x005	simu	01:02:03:04:05:...	0.0.0.0	5	0	RFP 32	✗	✗	Select columns
Capturing	0x006	simu	01:02:03:04:05:...	0.0.0.0	5	0	RFP 32	✗	✗	
Enrolment	0x007	simu	01:02:03:04:05:...	0.0.0.0	5	0	RFP 32	✗	✗	
Export	0x008	simu	01:02:03:04:05:...	0.0.0.0	5	0	RFP 32	✗	✗	
	0x009	simu	01:02:03:04:05:...	0.0.0.0	5	0	RFP 32	✗	✗	
	0x00A	simu	01:02:03:04:05:...	0.0.0.0	5	0	RFP 32	✗	✗	
	0x00B	simu	01:02:03:04:05:...	0.0.0.0	5	0	RFP 32	✗	✗	

The **Active** column shows the following states:

- ✗ – DECT is not enabled and/or RFP not connected.
- ✗ – DECT is enabled and RFP connected, but DECT has not been activated yet.
- 🔍 – DECT is enabled and RFP is connected, but RFP is not synchronized and searches for other synchronized RFPs.
- ✓ – DECT is enabled and RFP is connected and synchronized.

**Note:** If the **Active** column is not displayed, you can activate it in the **Select columns** dialog, see section 6.7.1.7.

The tasks you can perform are mode-dependant.

Configuration mode	Monitor mode	See section
<b>Create:</b> create new base station in detail panel		6.7.1.2
<b>Configure:</b> configure selected base station in detail panel		6.7.1.3

Configuration mode	Monitor mode	See section
	<b>Show details:</b> show selected base station in detail panel	6.7.1.4
<b>Delete:</b> delete selected RFP		6.7.1.5
	<b>Show sync. relations:</b> show synchronization relation for selected RFPs	6.7.1.6
<b>Select columns:</b> select columns/parameters to be shown in RFP table	<b>Select columns:</b> select columns/parameters to be shown in RFP table	6.7.1.7
<b>Filter:</b> show only RFP datasets in table which contain a special search string	<b>Filter:</b> show only RFP datasets in table which contain a special search string	6.7.1.8

### 6.7.1.1 DECT Base Station Detail Panel

The DECT base station detail panel is used for configuration/display of RFP settings and creation of new RFP datasets.

To call up the DECT base station detail panel, do one of the following:

- choose one of the commands in the task bar on the right of the **DECT base stations** panel (**Create**, **Configure**, or **Show details**)
- double-click on the appropriate RFP entry in the RFP table.

The DECT base station detail panel contains the following parameter groups sorted in different tabs.

#### “Status” tab

This tab is only available in **Monitor Mode**. It shows system status information relating to the selected DECT base station.

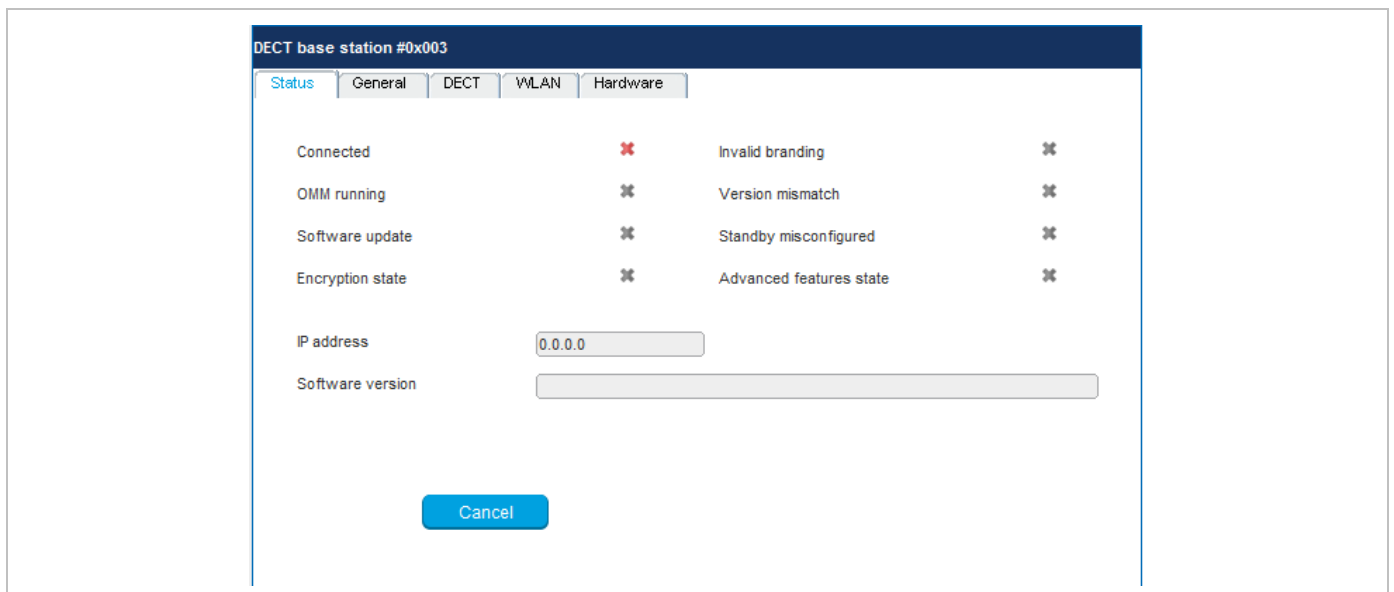

### “General” tab

This tab contains the general DECT base station parameters.

The screenshot shows the configuration window for a DECT base station #0x007. The 'General' tab is selected, and the following parameters are visible:

- Name:
- MAC address:
- Site:  (dropdown menu)
- Building:  (dropdown menu)
- Floor:
- Room:
- Conference channels:

Buttons for 'OK' and 'Cancel' are located at the bottom of the window.

### “DECT” tab

This tab contains the DECT base station's DECT parameters.

The screenshot shows the configuration window for a DECT base station #0x007, with the 'DECT' tab selected. The following parameters are visible:

- DECT switched on:
- DECT cluster:
- Paging area:  (dropdown menu)
- Preferred synchronisation source:
- Reflective environment:

Buttons for 'OK' and 'Cancel' are located at the bottom of the window.

**“WLAN” tab**

This tab contains the DECT base station's WLAN parameters. Settings in the **WLAN** tab apply to RFP 42 WLAN and RFP 43 WLAN base stations only.

The screenshot shows the configuration window for DECT base station #0x007. The 'WLAN' tab is selected, and the following settings are visible:

Parameter	Value
WLAN switched on	<input type="checkbox"/>
WLAN profile	1
Antenna diversity	<input type="checkbox"/>
Antenna	1
Channel	1
Output power level	Full
High throughput mode	<input type="checkbox"/>

Buttons: OK, Cancel

**“Hardware” tab**

In **Monitor Mode**, this tab shows hardware information of the selected DECT base station.

The screenshot shows the configuration window for DECT base station #0x007. The 'Hardware' tab is selected, and the following setting is visible:

Parameter	Value
Hardware type	RFP 32

Buttons: OK, Cancel

In configuration mode, the DECT base station **Hardware type** can be set if it is connecting to the OMM for the first time. Once the correct hardware type is received from the DECT base station, you cannot change it.

### 6.7.1.2 Adding New DECT Base Stations

You must be in **Configuration Mode** to add a new DECT base station. To add a DECT base station to the list of known base stations, do the following:

- 1 Click **Create** under the Tasks lists on the right side of the **DECT base stations** window.  
The **New radio fixed part** panel opens.
- 2 Configure the DECT base station (see parameter descriptions below).
- 3 Click **OK**.

The following parameters can be set in the tabs of the **New DECT base station** panel:

#### “General” tab

- **Name:** The name for the RFP.
- **MAC address:** Each RFP is identified by its unique MAC address (6 bytes hex format, colon separated). Enter the MAC address, it can be found on the back of the chassis.
- **Site:** If several sites exist, select the site the RFP is assigned to.
- **Building, Floor, Room:** For easier localization of the RFP you can enter data in these fields.
- **Conference channels:** Activate this option to enable the RFP to provide channels for 3-way conferencing. This option is available for RFP 35 / 36 / 37 / 43 (see section 7.20.7).

#### “DECT” tab

- **DECT switched on:** The DECT functionality for each RFP can be switched on/off.
- **DECT cluster:** If DECT is active the RFP can be assigned to a cluster.
- **Paging area:** Enter the paging area, the RFP is assigned to.

**Note:** The **Paging area size** is set in the **DECT** tab of the **System settings** menu (see section 6.5.1). The assignment between RFPs and paging areas can be changed in the **Paging areas** menu (see section 6.7.1.8).

- **Preferred synchronization source:** Activate this checkbox if the RFP should be used as synchronization source for the other RFPs in the cluster. For background information on RFP synchronization see section 7.2.
- **Reflective environment:** Within areas containing lot of reflective surfaces (e.g. metal or metal coated glass) in an open space environment the voice quality of a DECT call can be disturbed because of signal reflections which arrive on the DECT phone or RFP using multipath propagation. Calls may have permanent drop outs while moving and high error rates on the RFPs and DECT phones.  
For such environment Mitel has developed the DECT XQ enhancement into base stations (RFP 32/34 , RFP 42 WLAN and RFP 35/36/37 IP, RFP 43 WLAN) and the Mitel 600 DECT phones family. Using this enhancement by switching the **Reflective environment** flag on might reduce drop outs and cracking noise.

As soon as **Reflective environment** is switched on, the number of calls on an RFP 32/34 resp. RFP 42 WLAN or RFP 35/36/37 IP resp. RFP 43 WLAN is reduced to 4 calls at the same time.

**Please note:** The RFPs and DECT phones use more bandwidth on the Air Interfaces if the “Reflective environment” is switched on. Therefore this shall only be used when problems sourced by metal reflections are detected.



## “WLAN” tab

Settings in the **WLAN** tab apply to RFPs of the type “RFP 42 WLAN” and “RFP 43 WLAN” only. For details about WLAN configurations please see section 7.18.

**Please note:** WLAN properties can only be set if the correct hardware type is configured in the **Hardware** tab.

- **WLAN switched on:** The WLAN functionality for an RFP 42 WLAN or an RFP 43 WLAN can be switched on/off.
- For a description of the other parameters which can be set in the **WLAN** tab, see the description of the **DECT base stations** page of the OMM Web service (see section 5.6.3). The corresponding parameters can be found there in the **WLAN settings** section.

**Note:** Configuration of WLAN profiles is only possible with the OM Web service, see section 5.8.1.

## “Hardware” tab

WLAN properties can only be set if the correct hardware type is configured. This can be done manually before an RFP connects with the OMM and an automatic detection is possible (**Auto** setting).

### 6.7.1.3 Changing DECT base station configuration

Changing RFPs is only possible in **configuration mode**. To change the configuration of an existing RFP, do the following:

- 1 Select the appropriate RFP in the RFP table.
- 2 Click **Configure** under the Tasks lists on the right side of the **DECT base stations** window.  
The DECT base station detail panel opens.
- 3 Change RFP parameters (see descriptions in section 6.7.1.2).
- 4 Click **OK**.

### 6.7.1.4 Viewing DECT base station Details

You can view the configuration of an RFP in **Monitor Mode**. Proceed as follows:

- 1 Select the appropriate RFP in the RFP table.
- 2 Click **Show details** under the Tasks lists on the right side of the **DECT base stations** window.  
The DECT base station detail panel opens.
- 3 To close the RFP detail panel, click **Cancel**.

### 6.7.1.5 Deleting DECT base stations

You can only delete DECT base stations in **Configuration Mode**. To delete a DECT base station, do the following:

- 1 Select the DECT base station (s) in the table by selecting the corresponding checkbox(es).
- 2 Click **Delete** under the Tasks lists on the right side of the **DECT base stations** window.  
The **Delete selected DECT base station(s)** dialog opens showing a confirmation prompt.

- 3 Click **OK** to confirm.

**Please note:** License DECT base stations cannot be deleted.

### 6.7.1.6 Showing Synchronization Relations

You can view the synchronization relations of a DECT base station in **Monitor Mode**. Do the following:

- 1 Select the appropriate RFPs in the RFP table. At least two RFPs must be selected to show their synchronization relations.
- 2 Click **Show sync. Relations** under the Tasks lists on the right side of the **DECT base stations** window.

The view switches to the **Sync view** menu . For further information see section 6.7.6.

### 6.7.1.7 Selecting Columns

You can adapt the parameters shown in the RFP table to your needs:

- 1 Click **Select columns** under the Tasks lists on the right side of the **DECT base stations** window.  
The **Select columns** dialog opens.

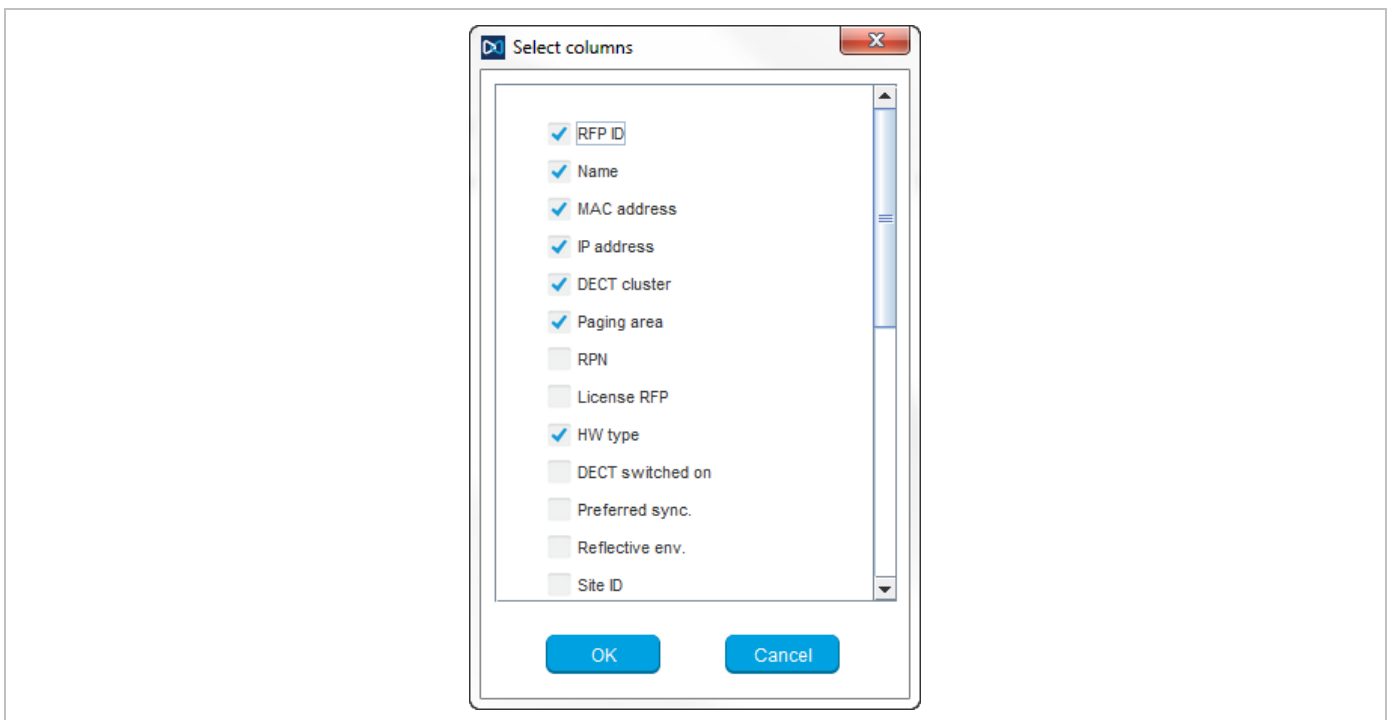

- 2 Select the columns that shall be shown by activating the appropriate checkboxes.
- 3 Click the **OK** button.

The DECT base station table is updated accordingly.

### 6.7.1.8 Filtering the DECT base station table

You can filter the list of DECT base station datasets shown in the table by using a filter.

- 1 Click **Filter** under the Tasks lists on the right side of the **DECT base stations** window.  
The **Filter** dialog opens.

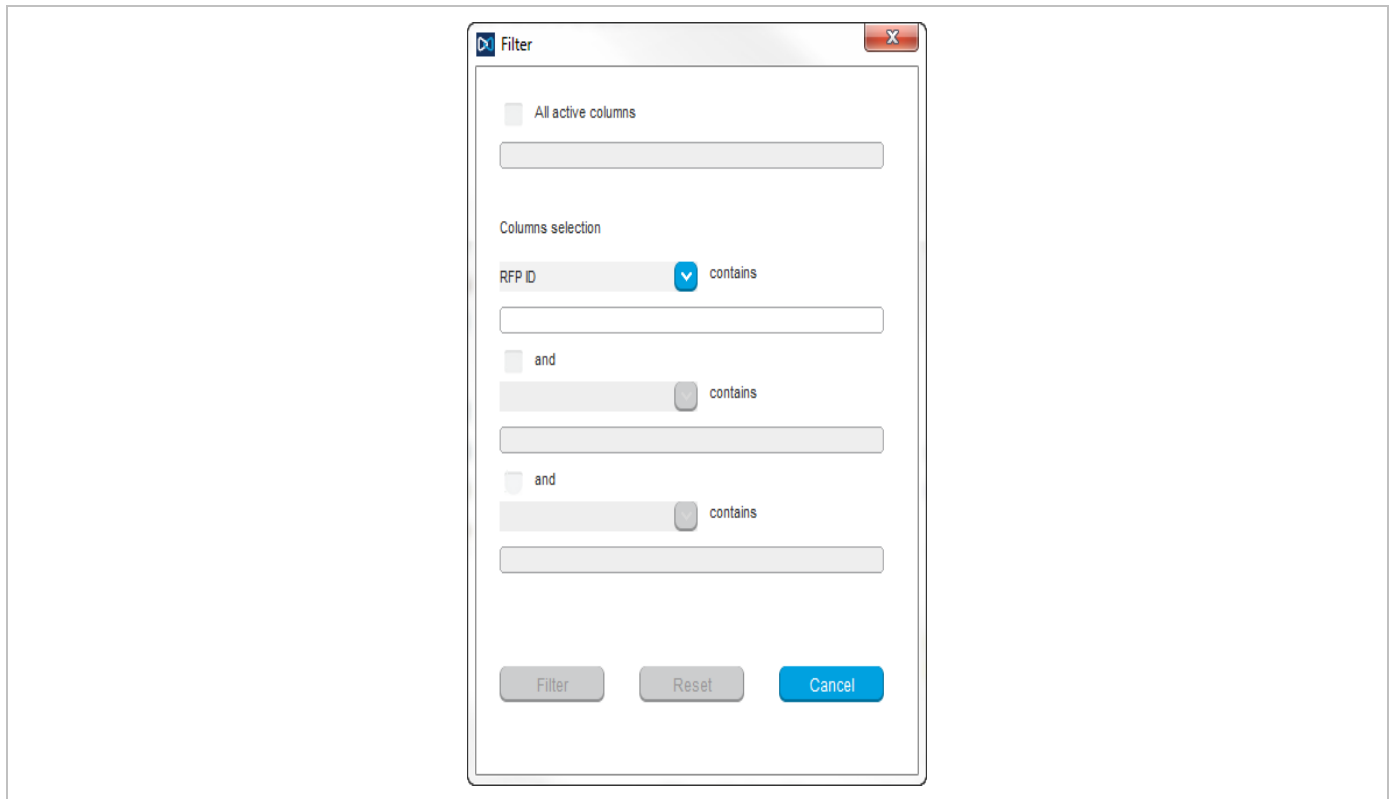

- 2 Enter the search string that serves as filter criterion. You can enter digits and characters. The search is case sensitive.
- 3 Click on the **Filter** button.  
The **Filter** dialog is closed and the table is adjusted accordingly.
- 4 To reset the filter, click on the **Filter** command in the task bar on the right of the **DECT base stations** panel.
- 5 In the **Filter** dialog click on the **Reset** button.

### 6.7.2 “PAGING AREAS” MENU

The **Paging area** menu shows all configured RFPs in a tree structure consisting of two trees:

- The left **Unassigned RFPs** tree contains all RFPs without an assigned paging area.
- The right **Paging areas** tree shows all configured paging areas with RFPs assigned to these paging areas.

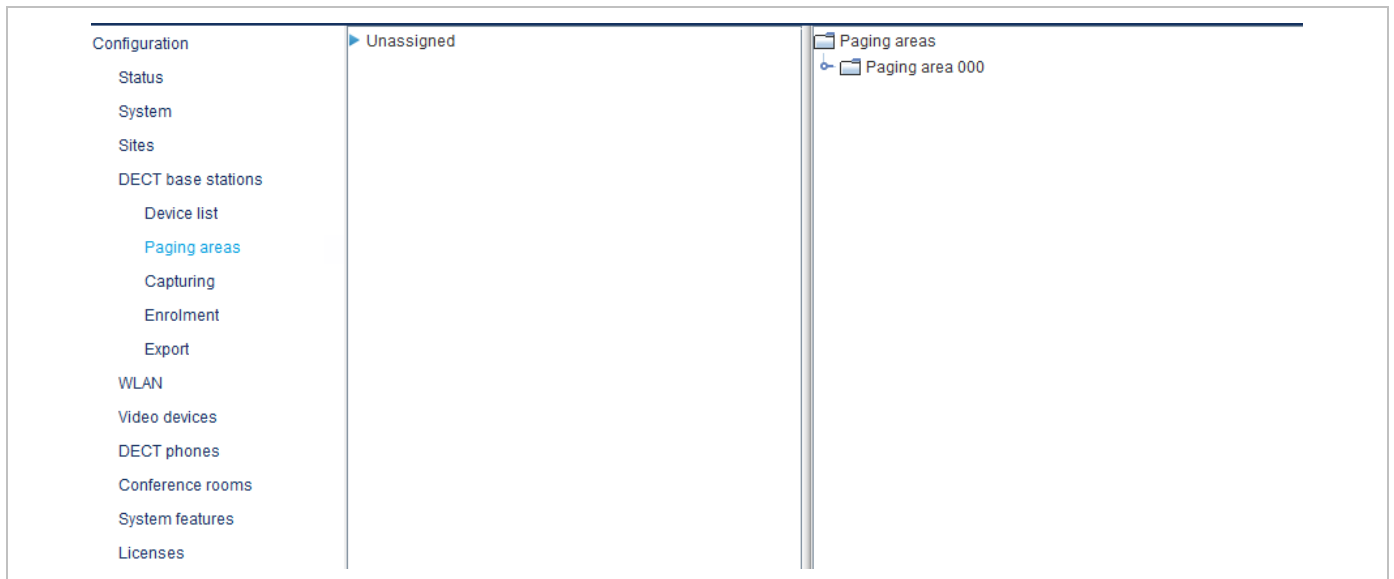

All DECT base stations are shown including their site and optional hierarchy (building, floor, and room) settings.

- DECT base stations can be moved by drag and drop from unassigned tree to paging area tree and vice versa, as well as between different paging areas inside the paging area tree.
- Only one DECT base station node can be moved at once.
- If a site or a hierarchy node is selected, all DECT base stations that are children of this node are moved.
- If a paging area is completely filled with DECT base stations, moving additional DECT base stations in that paging area is not permitted.
- If not all DECT base stations (selected by a site or hierarchy node) can be moved into a paging area, you are asked if you want to move as many DECT base stations as possible or if the operation should be cancelled.

**Note:** The **Paging area size** is set in the **DECT** tab of the **System settings** menu (see section 6.5.1).

### 6.7.3 “CAPTURING” MENU

OMP supports the capture of DECT base stations that try to connect to OMM. These DECT base stations are assigned to OMM by DHCP options or OMM Configurator settings. Capturing is only accessible in **Configuration Mode**.

The screenshot shows the OMM Configuration Mode interface. On the left is a navigation menu with the following items: Configuration, Status, System, Sites, DECT base stations (with sub-items: Device list, Paging areas, Capturing, Enrolment, Export), WLAN, Video devices, DECT phones, Conference rooms, System features, and Licenses. The 'Capturing' item is highlighted in blue. The main content area is a table with columns: MAC address, IP address, HW type, WLAN suppo..., Radio type, Outdoor type, Freq. shift su..., Configuratio..., and Tasks. The 'Tasks' column contains a list of actions: Capturing (with a green checkmark), Add all, Add selected, Remove all, Remove selected, and Select columns.

Available tasks:

- **Capturing:** Start/stop capturing (active capturing is indicated with a green check mark)
- **Add all:** Add all captured DECT base stations to OMM
- **Add selected:** Add selected DECT base stations to OMM
- **Remove all:** Remove selected DECT base stations from list (without adding to OMM)
- **Remove selected:** Remove selected DECT base stations from list (without adding to OMM)
- **Select columns:** Select DECT base station capturing table columns to be shown

### 6.7.4 “ENROLMENT” MENU

The **Enrolment** menu allows import of DECT base station datasets using a configuration file. For information about required configuration file format see section 10.2.



The screenshot shows the OMM Configuration Mode interface with the 'Enrolment' menu item highlighted in blue. The main content area displays a form titled 'Select RFP enrolment import file'. It features a blue 'File' button with a document icon, a text input field, and a grey 'Show log file' button.

1 Click the **File** button.

A file system dialog opens in which you can select the configuration file. The configuration file must be encoded in UTF-8.

2 To check the results from reading the configuration file press the **Show log file** button. In case of file format errors these errors are listed here.

If reading of configuration file is successful, all DECT base station datasets read are shown in a newly created table. This table contains, apart from some DECT base station parameters, the **Status** column which shows the current import status for every DECT base station dataset:

-  – Not enrolled yet
-  – Enrolment failed
-  – OK (Enrolment successful)

3 Start the import by selecting one of the following commands:

**Add all:** import all DECT base station datasets into the OMM.

**Add selected:** import selected DECT base station datasets to the OMM. For selection activate the corresponding checkboxes in the DECT base station table.

**Remove all:** remove all DECT base station datasets from table. The table will be hidden.

**Remove selected:** remove selected DECT base station datasets from table. If the table is empty after removing of datasets, the table will be hidden. For selection activate the corresponding checkboxes in the DECT base station table.

**Show status:** show import status of a selected DECT base station dataset. If enrolment failed for this DECT base station, a message describing the enrolment error is shown.

**Select columns:** select the columns that shall be shown in DECT base station table (see also 6.7.1.7).

### 6.7.5 “EXPORT” MENU

The **Export** menu allows export of all DECT base stations enrolled to the OMM to a “.csv” file. The generated file can be viewed with a standard spreadsheet application.

All enrolled DECT base stations are shown in a table.

Configuration	<input type="checkbox"/>	MAC address	Name	DECT cluster	Paging area	Site ID	HW type	Tasks
Status	<input checked="" type="checkbox"/>	00:30:42:18:1D:BD	SVE RFP1	1	0	3	RFP 35	Export all Export selected Select parameters Select columns
	<input type="checkbox"/>	00:30:42:18:20:A2	SVE RFP2	1	0	3	RFP 35	
System	<input type="checkbox"/>	01:02:03:04:05:06	simu	5	0	1	RFP 32	
	<input type="checkbox"/>	01:02:03:04:05:07	simu	5	0	1	RFP 32	
Sites	<input type="checkbox"/>	01:02:03:04:05:08	simu	5	0	1	RFP 32	
	<input type="checkbox"/>	01:02:03:04:05:09	simu	5	0	1	RFP 32	
DECT base stations	<input type="checkbox"/>	01:02:03:04:05:0A	simu	5	0	1	RFP 32	
	<input type="checkbox"/>	01:02:03:04:05:0B	simu	5	0	1	RFP 32	
Device list	<input type="checkbox"/>	01:02:03:04:05:0C	simu	5	0	1	RFP 32	
	<input type="checkbox"/>	01:02:03:04:05:0D	simu	5	0	1	RFP 32	
Paging areas	<input type="checkbox"/>	01:02:03:04:05:0E	simu	5	0	1	RFP 32	
	<input type="checkbox"/>	01:02:03:04:05:0F	simu	5	0	1	RFP 32	
Capturing	<input type="checkbox"/>							
Enrolment	<input type="checkbox"/>							
Export	<input type="checkbox"/>							

The following tasks can be performed:

- **Export all:** export all DECT base station datasets.
- **Export selected:** export selected DECT base station datasets.

- **Select parameters:** select DECT base station parameters to be written to the .csv file (select all DECT base station parameters or a subset of these parameters).
- **Select columns:** select the columns to be written to the .csv file.

When the export begins, a file system dialog opens where you can select the export file name. If all parameters are selected for export, the export file can be re-imported using the Enrolment function (see section 6.7.3). For information about DECT base station export file format see Appendix, section 10.3).

## 6.7.6 “SYNC VIEW” MENU

The **Sync view** menu allows verification of the synchronization between DECT base stations in a graphical manner.

**Note:** For information on DECT base station synchronization, see section 7.2.

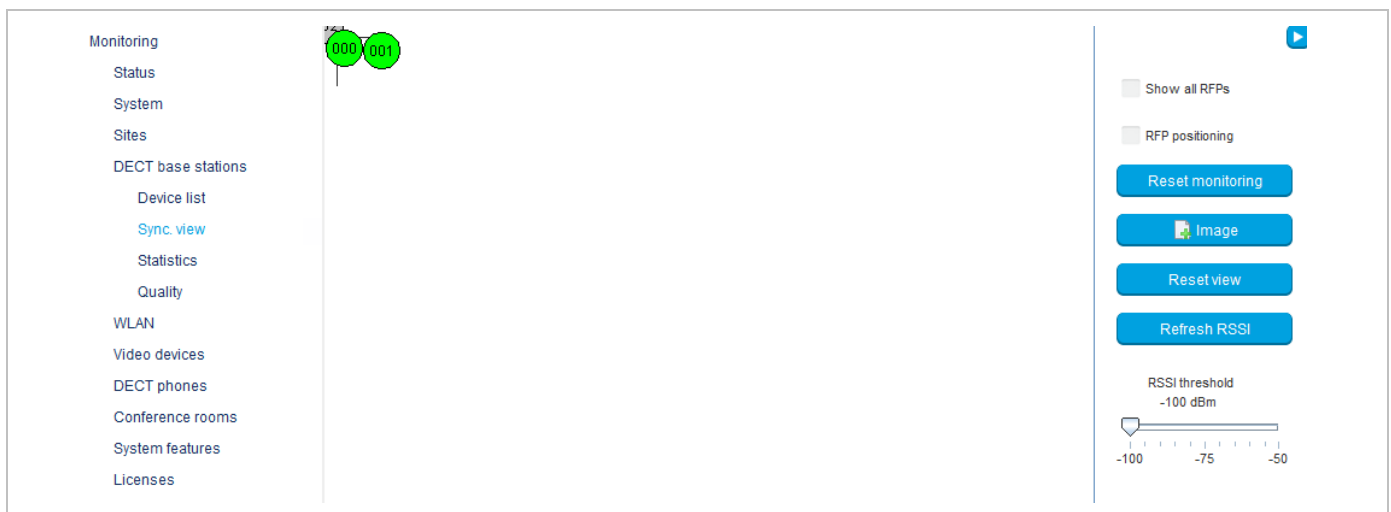

To open the task panel, click the arrow icon in the upper right corner of the **Sync view** panel.

The task panel is displayed on the right. The following tasks can be performed:

- **Show all RFPs:** If this checkbox is activated, all configured RFPs are shown in the sync panel; else only selected RFPs are shown.
- **RFP positioning:** If this checkbox is activated, RFP positions can be changed; else RFP positions are fixed.
- **Reset monitoring:** reset all active sync view monitoring relations.
- **Image:** select background image for sync panel.
- **Reset view:** reset selected view (zero coordinates are reset to the left upper corner of the sync view panel).
- **Refresh RSSI:** request new RSSI values from OMM for active sync relations.

### Viewing sync relations

DECT base stations for which sync relations shall be shown, can be selected as follows:

- Select (more than one) DECT base station in device list table  
or
- Activate DECT base station mouse menu in sync view: Press the right mouse button while mouse cursor is on an DECT base station icon and select the **Activate Monitoring** command from the context menu.

The color of the DECT base station icon indicates synchronization state of that DECT base station:

- Grey: inactive
- Red: not synchronized
- Yellow: searching
- Green: synchronized

Sync relations between DECT base stations are represented by arrows.

### Viewing RSSI values

The color of the arrows between DECT base stations is an indication of the RSSI value of the link:

- Red: RSSI < -90 dBm
- Orange: -90 dBm <= RSSI <= -70 dBm
- Green: RSSI > -70 dBm

If the mouse is moved over a DECT base station with monitoring activated, a tool tip with RSSI values is displayed.

You can use the **RSSI threshold** slider to limit the display of values in the tool tip.

## 6.7.7 “STATISTICS” MENU

The **DECT base stations** -> **Statistics** menu provides information about DECT base station statistics counters. It contains:

- an overview panel with all statistics counters (see section 6.7.7.1)
- multiple statistics group panels, where related statistics counter types are grouped together (see section 6.7.7.2).

The menu is only available in **Monitor Mode**.

### 6.7.7.1 DECT base station Statistics Overview

The DECT base station statistics overview page contains a list of DECT base stations by ID, and an overview of all DECT base station statistics counters.



	RFP ID	Element ID	Group	Counter	Value	Tasks
Monitoring	0x000	0	Voice channels	Only 2 voice channels fr...	0	
	0x001	1	Voice channels	Only 1 voice channels fr...	0	
Status	0x002	2	Voice channels	Voice channels busy	0	Refresh RFP
System	0x003	3	Voice channels	Voice channels busy an...	0	
	0x004	4	Air channels	Only 2-4 air channels free	0	Refresh all
Sites	0x005	5	Air channels	Only 1 air channel free	0	
	0x006	6	Air channels	Air channels busy	0	Clear RFP
DECT base stations	0x007	7	Paging	Paging queue overflows	0	
Device list	0x008	8	Sync	Synchronisation losts	0	Clear all
Sync. view	0x009	9	Sync	Low relations	0	
Statistics	0x00A	10	Sync	Offset jumps	0	
	0x00B	11	RFP health	RFP resets	0	
Voice channels		12	RFP health	RFP connection timeouts	0	
		13	BMC: Connections	01 - 03	1368	
Air channels		14	BMC: Connections	04 - 06	0	
		15	BMC: Connections	07 - 09	0	
Paging		16	BMC: Connections	10 - 12	0	
		17	BMC: DSP chan used	01 - 02	286	
Sync		18	BMC: DSP chan used	03 - 04	3	
		19	BMC: DSP chan used	05 - 06	0	
RFP health		20	BMC: DSP chan used	07 - 08	0	
		21	BMC: Miscellaneous	Lost connections	19	
BMC: Connections		22	BMC: Miscellaneous	MAC reset	20	
		23	BMC: Miscellaneous	Reject dummy	0	
BMC: DSP chan usec		24	BMC: Miscellaneous	Ho timer > 150ms	244	
		25	BMC: Frame error rate	Bad frames	9427	
BMC: Miscellaneous		26	BMC: Frame error rate	Good frames	625409	
		27	BMC: Frame error rate	Frame error rate in 1/1000	15	
Quality						
WLAN						
Video devices						

The following tasks can be performed:

- **Refresh RFP:** request counter update by OMM for selected DECT base station statistics counters.
- **Refresh all:** request counter update by OMM for all DECT base station statistics counters.
- **Clear RFP:** clear all DECT base station statistics counters on selected DECT base station.
- **Clear all:** clear all DECT base station statistics counters.

If a DECT base station is selected (left **RFP ID** table), the statistics counter table shows counter values for that DECT base station (right table). When a statistics counter entry is selected, a detail panel opens which shows more detailed information for that counter.

The detail panel shows values for total occurrence and occurrence in current and last week. You can clear the selected statistics counter on the selected DECT base station by pressing the **Clear** button.

### 6.7.7.2 DECT base station Statistics Group Panels

The DECT base station statistics group panels divide DECT base station statistics counters into logical groups. This allows display of all statistics counters of a special group of all DECT base stations in one table.

The group panels are listed under the **Statistics** menu entry in the left panel.

Note that with SIP-DECT 6.0 or later, the statistic data collected by the BMC part of each DECT base station device (in the DECT MAC layer) are now shown with the DECT base station statistic data collected by the OMM.

As an update between OMM and DECT base station usually occurs once every hour, it can take up to one hour for an event that increments a BMC statistic counter to appear in the OMP.

The following tasks can be performed:

- **Refresh RFP:** request counter update by OMM for selected DECT base station.
- **Refresh all:** request counter update by OMM for all counters.
- **Clear group RFP:** clear counter group of selected DECT base stations.
- **Clear group:** clear counter group of all DECT base stations.

- **Clear RFP:** clear all counters of selected DECT base station.
- **Clear all:** clear all counters of all DECT base stations.

### 6.7.8 “QUALITY” MENU

OMP provides a monitoring ability for critical IP network parameters. Administrators can check basic network quality information for all DECT base stations. This includes Voice quality (Jitter, Packet lost) and OMM to RFP link quality (Roundtrip delay).

The menu is only available in **Monitor Mode**.

#### 6.7.8.1 IP

IP quality menu provides information about link quality between DECT base stations and OMM.

Monitoring	ID	Connecte...	Current R...	Max. RTT...	Count	< 25 msec	< 50 msec	< 150 msec	< 500 msec	>= 500 m...	Tasks
Status	0x000	354270	0.5	5.6	23617	23617	0	0	0	0	Select columns
System	0x001	354270	0.7	1.0	23617	23617	0	0	0	0	
Sites											
DECT base stations											
Device list											
Sync. view											
Statistics											
Quality											
IP											
Media stream											
Synchronization											

Displayed parameters:

- **ID:** Radio fixed part identifier
- **Connected time:** Time the RFP is connected to OMM (sec)
- **Current RTT:** Current roundtrip time between RFP and OMM (msec)
- **Max. RTT:** Maximal detected roundtrip time between RFP and OMM
- **Count:** Number of roundtrip time measures
- **< 25 msec:** Number of roundtrip time measures lower than 25 msec
- **< 50 msec:** Number of roundtrip time measures between 25 and 50 msec
- **< 150 msec:** Number of roundtrip time measures between 50 and 150 msec
- **< 500 msec:** Number of roundtrip time measures between 150 and 500 msec
- **>= 500 msec:** Number of roundtrip time measures 500 msec and more

Available tasks:

- **Select columns:** Columns to be shown in IP quality table

### 6.7.8.2 Media Stream

Media stream panel provides information about voice quality.

Monitoring		ID	Connects	Duration [sec]	TX packets	RX packets	Lost packets	Max. jitter [msec]	Tasks
Status	<input type="checkbox"/>	0x000	24	124	10553	11893	3	1	Clear RFP Clear all Select columns
System	<input type="checkbox"/>	0x001	7	36	2120	3409	0	0	
Sites	<input type="checkbox"/>	0x002	0	0	0	0	0	0	
DECT base stations	<input type="checkbox"/>	0x003	0	0	0	0	0	0	
Device list	<input type="checkbox"/>	0x004	0	0	0	0	0	0	
Sync. view	<input type="checkbox"/>	0x005	0	0	0	0	0	0	
Statistics	<input type="checkbox"/>	0x006	0	0	0	0	0	0	
Quality	<input type="checkbox"/>	0x007	0	0	0	0	0	0	
IP	<input type="checkbox"/>	0x008	0	0	0	0	0	0	
Media stream	<input type="checkbox"/>	0x009	0	0	0	0	0	0	
Synchronization	<input type="checkbox"/>	0x00A	0	0	0	0	0	0	
	<input type="checkbox"/>	0x00B	0	0	0	0	0	0	

Displayed parameters:

- **ID:** Radio fixed part identifier
- **Connects**
- **Duration (sec)**
- **TX packets**
- **RX packets**
- **Lost packets**
- **Max. jitter(msec)**

Available tasks:

- **Clear RFP:** Clear values for selected RFPs
- **Clear all:** Clear values for all RFPs
- **Select columns:** Select media stream quality table columns to be shown

### 6.7.8.3 Synchronization

Synchronization panel allows checking the synchronization status of RFPs which allows identifying RFPs with bad synchronization coverage.

Synchronization monitoring can optionally be run in snapshot mode. If this mode is activated, data update must be triggered by a user otherwise data were updated automatically anytime if new values arrive from OMM.

Monitoring		ID	DECT cluster	Sync. state	Strong relations	Low relations	Max. RSSI [dBm]	Min. RSSI [dBm]	Tasks
Status	<input type="checkbox"/>	0	1	✓	1	0	-43	-43	Snapshot mode Update Select columns
System	<input type="checkbox"/>	1	1	✓	1	0	-42	-42	

Available parameters:

- **ID:** Radio fixed part id
- **DECT cluster:** Cluster of the RFP
- **Sync state:** Synchronization state of the RFP
- **Strong relations**
- **Low relations**
- **Max. RSSI (dBm)**
- **Min. RSSI (dBm)**

Available tasks in media synchronization quality table:

- **Snapshot mode:** Enable snapshot mode (green check mark indicates snapshot mode is on)
- **Update:** Request data update in snapshot mode
- **Select columns:** Select synchronization quality table columns to be shown

## 6.8 “WLAN” MENU

OMP supports configuration of WLAN profiles and provides an overview of wireless clients currently connected.

### 6.8.1 PROFILES

OMM supports up to 20 WLAN profiles, which can be added, changed and deleted in OMP configuration mode. Configuration and state of any WLAN profile can be checked in monitoring mode.

#### 6.8.1.1 WLAN Profiles - configuration mode

WLAN profile configuration menu provides an overview of all configured WLAN profiles.

<ul style="list-style-type: none"> <li>Configuration</li> <li>Status</li> <li>System</li> <li>Sites</li> <li>DECT base stations</li> <li>WLAN             <ul style="list-style-type: none"> <li>Profiles</li> </ul> </li> <li>Video devices</li> <li>DECT phones</li> <li>Conference rooms</li> <li>System features</li> <li>Licenses</li> </ul>	<table border="1"> <thead> <tr> <th>ID</th> <th>Enabled</th> <th>Profile type</th> <th>Mode</th> <th>SSID 1</th> <th>DECT base stations</th> </tr> </thead> <tbody> <tr> <td colspan="6" style="height: 150px;"> </td> </tr> </tbody> </table>	ID	Enabled	Profile type	Mode	SSID 1	DECT base stations							<b>Tasks</b> <ul style="list-style-type: none"> <li>Create profile</li> <li>Configure profile</li> <li>Delete profile</li> <li>Delete all profiles</li> <li>Configure MAC filter</li> <li>Select columns</li> </ul>
ID	Enabled	Profile type	Mode	SSID 1	DECT base stations									

The following tasks are available in this menu:

- **Create profile:** Create a new WLAN profile (available if the maximal number of 10 WLAN profiles is not yet reached)
- **Configure profile:** Reconfigure selected profile
- **Delete profile:** Deletes a selected profile (only available if selected profile is not in use by any Radio fixed part)

- **Delete all profiles:** Deletes all existing profiles (only available if none of these profiles is in use by any Radio fixed part)
- **Configure MAC filter:** Add, configure, delete MAC filter for selected profile
- **Select columns:** Select WLAN profile table columns to be shown

### 6.8.1.2 WLAN Profiles Monitoring Mode

WLAN profile monitoring menu shows all configured WLAN profiles.

The following tasks are available:

- **Show Profile:** Show details of selected WLAN profile
- **Show MAC filter:** Show configured MAC filter of selected WLAN profile
- **Select columns:** Select WLAN profile table columns to be shown

### 6.8.1.3 WLAN Profile Detail Panel

WLAN profile detail panel is used to create, reconfigure or show a profile. It consists of different tabs which are used for general settings of WLAN profile, SSID configuration and SSID security settings.

WLAN profile detail panel is opened if one of the following tasks is performed in WLAN profile menu:

- **Create profile** (configuration mode)
- **Configure profile** (configuration mode)
- **Show profile** (monitoring mode)

The “General” tab is always shown and configures/shows general settings of this profile like enabling of profile and profile type.

The screenshot displays the 'General' tab of the WLAN Profile Detail Panel. The configuration options are as follows:

Setting	Value
Profile enabled	<input checked="" type="checkbox"/>
Avoid interferences	<input type="checkbox"/>
Profile type	RFP43
802.11 mode	802.11n
WME	<input checked="" type="checkbox"/>
Maximal bit rate	Mbps
Beacon interval	100 msec
DTIM interval	5 Beacons
RTS threshold	2347 Bytes
Fragmentation threshold	2346 Bytes

Buttons: OK, Cancel

The “SSID selection” tab is used for enabling of SSIDs. At least “SSID 1” is always enabled. “SSID 2”, “SSID 3” and “SSID 4” can be activated optional.

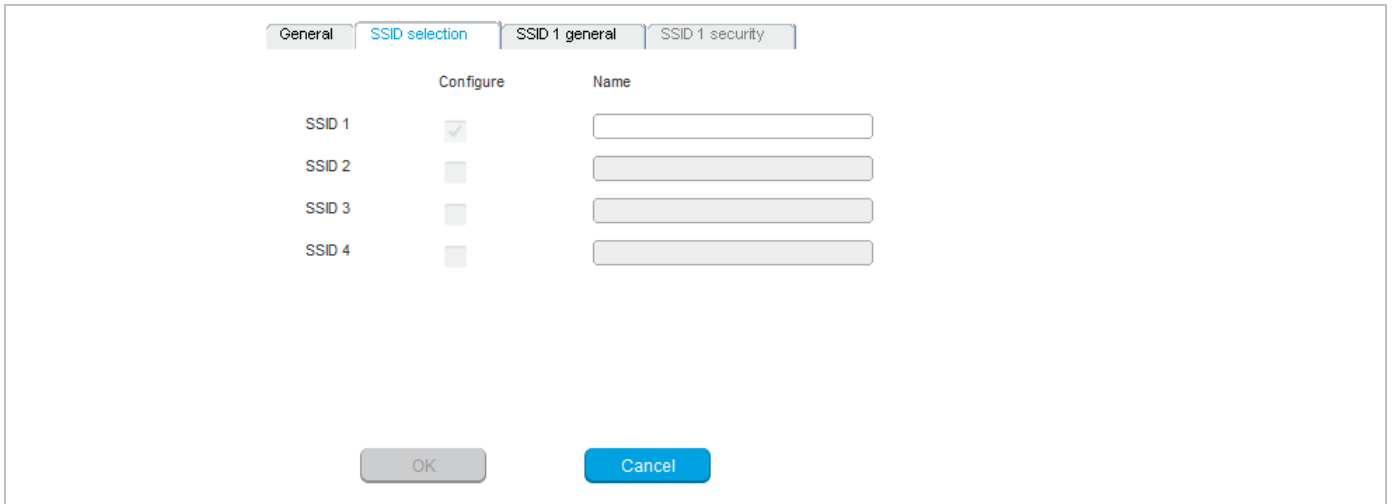

The “SSID x general” tab is shown for any activated SSID. Among other things, you can use it to select Security type.

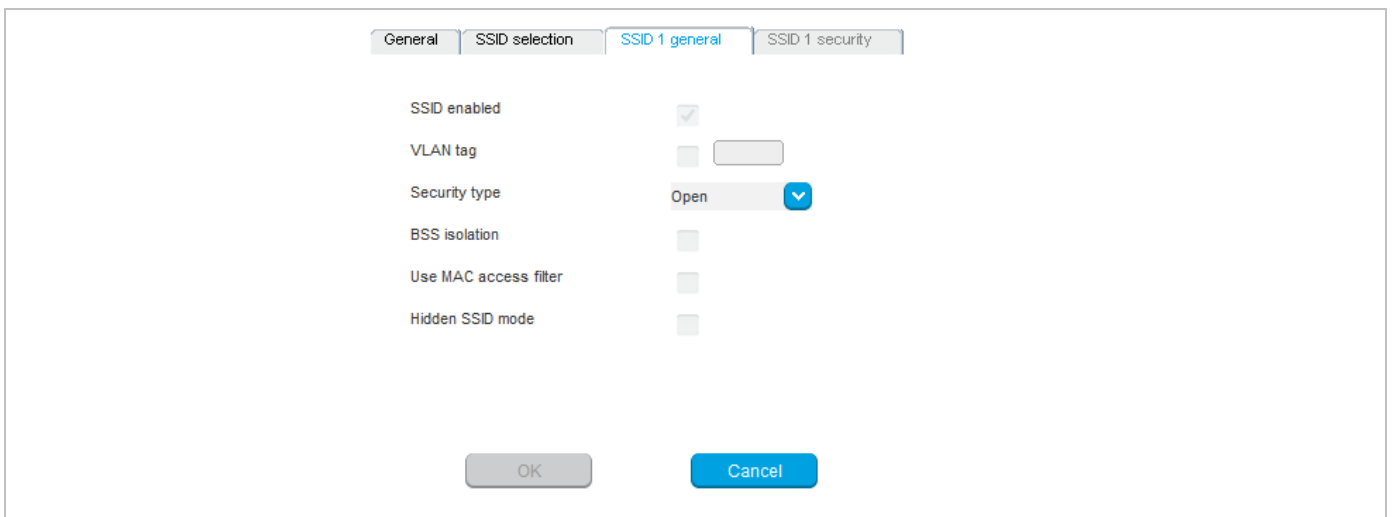

A tab “SSID x security” is shown as well. It is accessible only for SSIDs with security type set to “WEP” or “WPA”. If security type stays at “Open” this tab is inactive. It allows setting of all necessary security parameters for this SSID.

#### 6.8.1.4 MAC Access Filter Detail Panel

**MAC access filter detail** panel in configuration mode allows the adding, configuring and deleting of MAC access filters. File import and export of MAC access filters is supported as well.

Monitoring mode shows all configured MAC access filters only.

MAC access filter detail panel is opened if one of the following tasks is performed in WLAN profile menu:

- **Configure MAC filter** (configuration mode)
- **Show MAC filter** (monitoring mode)

The “General” tab in configuration mode shows all configured MAC access filter.

The following actions are available:

- **Create:** Create new MAC access filter
- **Configure:** Change name of selected MAC access filter
- **Delete:** Delete all selected MAC access filter

The “Import” tab (configuration mode only) provides import of a list of MAC access filter from file.

The “Export” tab (configuration mode only) provides export of all configured MAC access filters to file. If no MAC access filter is configured, this tab is inactive.





### 6.8.1.5 Clients

WLAN clients menu which is available in monitoring mode only, shows all currently connected wireless clients.

## 6.9 “VIDEO DEVICES” MENU

The **Video devices** panel lists all configured video devices. The device list is available in **Configuration Mode** as well as in **Monitor mode**.

New video device entries show up automatically after they are connected to and recognized by a DECT base station. The **Plugged** and **State** columns shows the following states:

-  / **unplugged** – Video device is not connected.
-  / **plugged** – Video device is connected.
-  / **started** – Video device is being watched in the OM Locating application.
-  / **stopped** – Video device is connected but disabled in the OMP.

The **Tag** column shows the USB ID of the connected video device. The **USB path** column shows the USB port number to be used, e.g. “1” is a video device connected directly to the RFP while “1.1” indicates an indirect connection using an USB hub.

The tasks which can be performed are mode-dependant.

Configuration mode	Monitor mode	See section
<b>Configure:</b> configure selected video device in detail panel		0
	<b>Show details:</b> show selected video device in detail panel	6.9.2
<b>Delete:</b> delete selected disconnected video device		6.9.3
<b>Filter:</b> show only video device entries in table which contains a special search string	<b>Filter:</b> show only video device entries in table which contains a special search string	0

### 6.9.1 CHANGING VIDEO DEVICES

Changing video devices is only possible in **Configuration Mode**. To change the configuration of an existing video device, do the following:

- 1 Select the appropriate video device in the video devices table.
- 2 In the task bar on the right of the **Video devices** panel click on the **Configure** command.  
The video device detail panel opens.
- 3 Change video device parameters, see description below.
- 4 Press the **OK** button.

**Please note:** You cannot change the configuration for a video device that is being watched in the OM Locating application (**State** column shows “active”). You must disable the video device first by deactivating the **Active** option.

The following parameters can be set in the **General** tab of the **Video devices** panel:

- **Active:** Disable this option to switch off the video device. This also switches off the status LED of the video device immediately (if applicable).
- **Name:** Enter a meaningful name for the video device.
- **Building, Floor, Room:** For easier localization of the video device you can enter data in these fields.
- **Resolution:** Select a resolution for the video device. Higher resolutions require more bandwidth when watching the video image in the OM Locating application. Note, that not all video devices support all available resolutions. Default: “VGA (640 x 480)”.
- **Frame rate:** Select a frame rate (2-10 frames per second). Higher frame rates require more bandwidth when watching the video image in the OM Locating application.

### 6.9.2 VIEWING VIDEO DEVICE DETAILS

You can view the configuration of a video device in **monitor mode**. Proceed as follows:

- 1 Select the appropriate video device in the video devices table.
- 2 In the task bar on the right of the **Video devices** panel click on the **Show details** command.  
The video device detail panel opens (see 0).
- 3 Click **Cancel** to close the video device detail panel.

### 6.9.3 DELETING VIDEO DEVICES

Deleting video devices is only possible in **Configuration Mode**. To delete one or more existing video devices proceed as follows:

- 1 Select the appropriate video device(s) in the video devices table by activating the corresponding checkbox(es). Note that you can only delete disconnected video devices.
- 2 In the task bar on the right of the **Video devices** panel click on the **Delete** command.  
The **Delete selected video devices(s)** dialog opens showing a confirmation prompt.
- 3 Confirm the displayed prompt with **OK**.



## 6.9.4 FILTERING VIDEO DEVICE TABLE

You can filter the list of video device entries shown in the video devices table by using a filter.

- 1 In the task bar on the right of the **Video devices** panel click on the **Filter** command.

The **Filter** dialog opens.

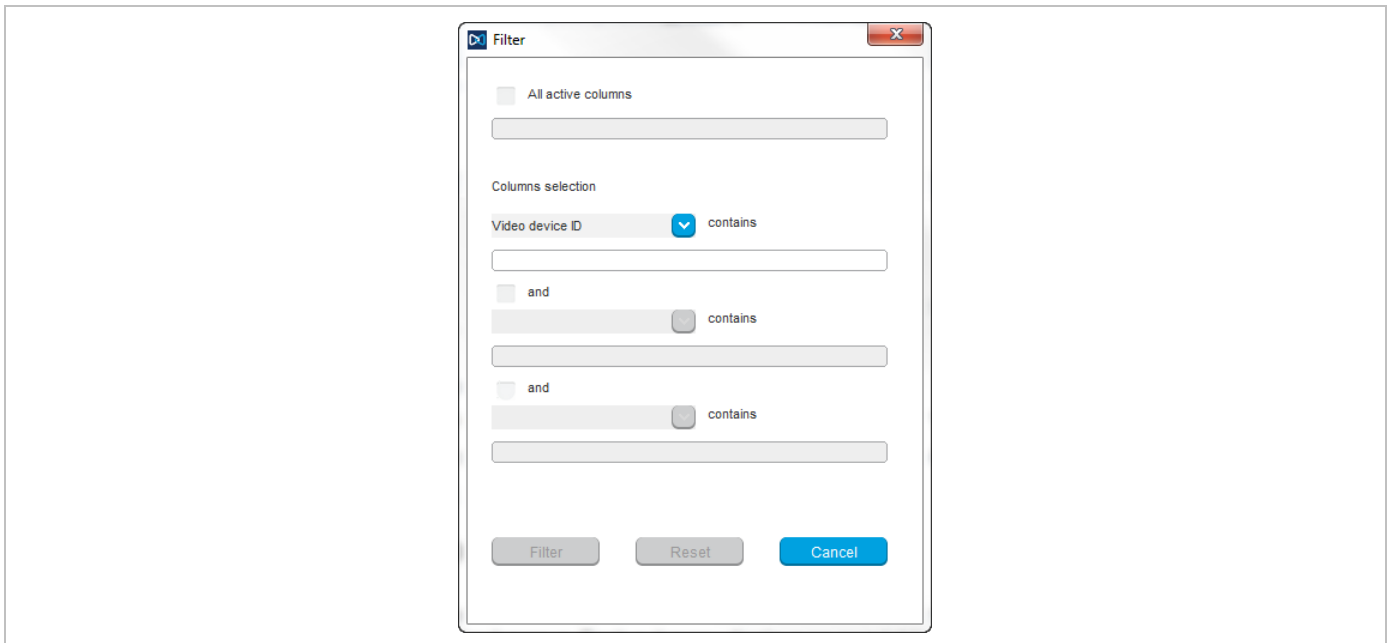

- 2 Enter the search string that serves as filter criterion. You can enter digits and characters. The search is case sensitive.
- 3 Click on the **Filter** button.  
The **Filter** dialog is closed and the video device table will be adapted accordingly.
- 4 To reset the filter, click on the **Filter** command in the task bar on the right of the **Video devices** panel.
- 5 In the **Filter** dialog click on the **Reset** button.

## 6.10 “DECT PHONES” MENU

DECT phone datasets can be configured and viewed in the **DECT phones** menu. The **DECT Phones** menu contains different submenus. Each submenu displays its own table of DECT phone datasets.

Configuration mode	Monitor mode	See section
<b>Overview:</b> Displays all user and device-related DECT phone data	<b>Overview:</b> Displays all user and device-related DECT phone data	6.10.1
<b>Users:</b> Displays all DECT phone user data		0
<b>Devices:</b> Displays all DECT phone device data	<b>Devices:</b> Displays all DECT phone device data	6.10.3
	<b>User monitoring:</b> Displays the status of all monitored users	7.29.7.3

## 6.10.1 "OVERVIEW" MENU

In the **Overview** panel, all user-related and device-related DECT phone data are listed in a table. The overview is available in **Configuration Mode** and **Monitor mode**.

Configuration	Device ID	IPEI	Name	Number/SIP user na...	User ID	User rel. type	Active	Tasks
Status	0x001	10345 0031639 *	x25052 612d	25052	0x001	Fixed	✓	Create Configure Delete Filter Subscription Wildcard subscription Select columns Change rel. type
	0x002	03586 0952116 0	x25053 622d	25053	0x002	Fixed	✓	
System	0x003	03586 0950946 7	x25054 622d	25054	0x003	Fixed	✓	
Sites	0x004	03586 0952129 3	x42052 622d	42052	0x004	Fixed	✓	
DECT base stations	0x05F	00100 0000000 3	simu pp 0	256001	0x04C	Fixed	✗	
	0x060	00100 0000001 4	simu pp 1	256002	0x04D	Fixed	✗	
	0x061	00100 0000002 5	simu pp 2	256003	0x04E	Fixed	✗	
WLAN	0x062	00100 0000003 6	simu pp 3	256004	0x04F	Fixed	✗	
	0x063	00100 0000004 7	simu pp 4	256005	0x050	Fixed	✗	
Video devices	0x064	00100 0000005 8	simu pp 5	256006	0x051	Fixed	✗	
DECT phones	0x065	00100 0000006 9	simu pp 6	256007	0x052	Fixed	✗	
	0x066	00100 0000007 *	simu pp 7	256008	0x053	Fixed	✗	
<b>Overview</b>	0x067	00100 0000008 0	simu pp 8	256009	0x054	Fixed	✗	
Users	0x068	00100 0000009 1	simu pp 9	256010	0x055	Fixed	✗	
Devices	0x069	00100 0000010 3	simu pp 10	256011	0x056	Fixed	✗	
Conference rooms	0x06A	00100 0000011 4	simu pp 11	256012	0x057	Fixed	✗	
	0x06B	00100 0000012 5	simu pp 12	256013	0x058	Fixed	✗	
System features	0x06C	00100 0000013 6	simu pp 13	256014	0x059	Fixed	✗	
Licenses	0x06D	00100 0000014 7	simu pp 14	256015	0x05A	Fixed	✗	
	0x06E	00100 0000015 8	simu pp 15	256016	0x05B	Fixed	✗	
	0x06F	00100 0000016 9	simu pp 16	256017	0x05C	Fixed	✗	
	0x070	00100 0000017 *	simu pp 17	256018	0x05D	Fixed	✗	
	0x071	00100 0000018 0	simu pp 18	256019	0x05E	Fixed	✗	
	0x072	00100 0000019 1	simu pp 19	256020	0x05F	Fixed	✗	
	0x073	00100 0000020 3	simu pp 20	256021	0x060	Fixed	✗	
	0x074	00100 0000021 4	simu pp 21	256022	0x061	Fixed	✗	
	0x075	00100 0000022 5	simu pp 22	256023	0x062	Fixed	✗	
	0x076	00100 0000023 6	simu pp 23	256024	0x063	Fixed	✗	
	0x077	00100 0000024 7	simu pp 24	256025	0x064	Fixed	✗	

In **Configuration Mode**, the **Overview** panel allows you to create **fixed** DECT phones (i.e., user and device are permanently associated).

The **Active** column shows the following states:

- ✗ - DECT phone is not subscribed to the system.
- ✓ - DECT phone is subscribed to the system.

**Note:** If the **Active** column is not displayed, you can activate it in the **Select columns** dialog, see section 6.10.9.

To view the user-device-relation, ensure that the **User ID** and **Device ID** columns are also activated.

In monitor mode you can view the registration status of a DECT phone user by activating the **Registered**, **Registrar server type**, **Registrar server** and **Registrar port** columns. See section 6.10.9 for information on selecting columns and section 7.20.6 for information on the SIP registration status.

	Device ID	IPEI	Subscri...	Number/SIP...	Last action	RFP ID	CC	MM	Info	Registe...	Tasks
Monitoring	0x001	10345 003163...	✓	25052	25.01. 21:42	0x000				✓	<ul style="list-style-type: none"> <li>Show details</li> <li>✖ Filter</li> <li>✖ Log events</li> <li>Select columns</li> </ul>
Status	0x002	03586 095211...	✓	25053	25.01. 22:12	0x001				✓	
System	0x003	03586 095094...	✓	25054	25.01. 20:42	0x001				✓	
Sites	0x004	03586 095212...	✓	42052	25.01. 22:25	0x000				✓	
DECT base stations	0x05F	00100 000000...	✗	256001	-	-				✗	
WLAN	0x060	00100 000000...	✗	256002	-	-				✗	
Video devices	0x061	00100 000000...	✗	256003	-	-				✗	
DECT phones	0x062	00100 000000...	✗	256004	-	-				✗	
Overview	0x063	00100 000000...	✗	256005	-	-				✗	
Devices	0x064	00100 000000...	✗	256006	-	-				✗	
User monitoring	0x065	00100 000000...	✗	256007	-	-				✗	
Conference rooms	0x066	00100 000000...	✗	256008	-	-				✗	
System features	0x067	00100 000000...	✗	256009	-	-				✗	
Licenses	0x068	00100 000000...	✗	256010	-	-				✗	
	0x069	00100 000001...	✗	256011	-	-				✗	
	0x06A	00100 000001...	✗	256012	-	-				✗	
	0x06B	00100 000001...	✗	256013	-	-				✗	
	0x06C	00100 000001...	✗	256014	-	-				✗	
	0x06D	00100 000001...	✗	256015	-	-				✗	
	0x06E	00100 000001...	✗	256016	-	-				✗	
	0x06F	00100 000001...	✗	256017	-	-				✗	
	0x070	00100 000001...	✗	256018	-	-				✗	
	0x071	00100 000001...	✗	256019	-	-				✗	
	0x072	00100 000001...	✗	256020	-	-				✗	

The tasks you can perform are mode-dependant.

Configuration mode	Monitor mode	See section
<b>Create:</b> create new fixed DECT phone dataset in detail panel		6.10.5
<b>Configure:</b> configure selected DECT phone user and device dataset in detail panel		6.10.6
	<b>Show details:</b> show selected DECT phone user and device dataset in detail panel	6.10.4
<b>Delete:</b> delete selected DECT phone user and device dataset (in case of fixed relation) or delete DECT phone user and set device to unbound status (in case of dynamic relation)		6.10.8
<b>Subscription:</b> start DECT phone subscription		6.10.7
<b>Wildcard subscription:</b> start DECT phone wildcard subscription		6.10.7
<b>Select columns:</b> select columns/parameters to be shown in DECT phone table	<b>Select columns:</b> select columns/parameters to be shown in DECT phone table	6.10.9
<b>Filter:</b> show only DECT phone datasets in table which contain a special search string	<b>Filter:</b> show only DECT phone datasets in table which contain a special search string	6.10.10
<b>Change rel. type:</b> change the DECT phone relation type		6.10.11
	<b>Log events:</b> enable/disable DECT phone event log	6.10.11

### 6.10.2 “USERS” MENU

Configuration	User ID	Name	Number/SIP user n...	Login/Add ID	User rel. type	Rel. devic...	Active	External	Tasks
Status	0x001	x25052 612d	25052		Fixed	0x001	✓	✗	Create Configure Delete Filter Select columns
	0x002	x25053 622d	25053		Fixed	0x002	✓	✗	
System	0x003	x25054 622d	25054		Fixed	0x003	✓	✗	
	0x004	x42052 622d	42052		Fixed	0x004	✓	✗	
Sites	0x04C	simu pp 0	256001		Fixed	0x05F	✗	✗	
DECT base stations	0x04D	simu pp 1	256002		Fixed	0x060	✗	✗	
	0x04E	simu pp 2	256003		Fixed	0x061	✗	✗	
WLAN	0x04F	simu pp 3	256004		Fixed	0x062	✗	✗	
	0x050	simu pp 4	256005		Fixed	0x063	✗	✗	
Video devices	0x051	simu pp 5	256006		Fixed	0x064	✗	✗	
DECT phones	0x052	simu pp 6	256007		Fixed	0x065	✗	✗	
Overview	0x053	simu pp 7	256008		Fixed	0x066	✗	✗	
Users	0x054	simu pp 8	256009		Fixed	0x067	✗	✗	
Devices	0x055	simu pp 9	256010		Fixed	0x068	✗	✗	
	0x056	simu pp 10	256011		Fixed	0x069	✗	✗	
Conference rooms	0x057	simu pp 11	256012		Fixed	0x06A	✗	✗	
	0x058	simu pp 12	256013		Fixed	0x06B	✗	✗	
System features	0x059	simu pp 13	256014		Fixed	0x06C	✗	✗	
	0x05A	simu pp 14	256015		Fixed	0x06D	✗	✗	
Licenses	0x05B	simu pp 15	256016		Fixed	0x06E	✗	✗	
	0x05C	simu pp 16	256017		Fixed	0x06F	✗	✗	
	0x05D	simu pp 17	256018		Fixed	0x070	✗	✗	

In the **Users** panel, all DECT phone user data are listed in a table. The **Users** panel allows you to create (unbound) users (which should be able to login and logout at a device).

**Note:** Use the **Select columns** dialog (see section 6.10.9) to display the desired DECT phone user data.

The following tasks can be performed:

- **Create:** create new unbound DECT Phone user dataset (see section 6.10.5).
- **Configure:** configure selected DECT Phone user dataset (see section 6.10.6).
- **Delete:** delete selected DECT Phone user dataset. Also delete device data in case of a fixed relation (see section 6.10.8).
- **Select columns:** select parameter columns to be shown in table (see section 6.10.9).
- **Filter:** filter DECT phone datasets shown in table for string set in filter mask (see section 6.10.10).
- **Change rel. type:** change the DECT phone relation type (see section 6.10.11).

### 6.10.3 “DEVICES” MENU

In the **Devices** panel, all DECT phone device data are listed in a table. The **Device** panel allows you to configure the DECT part of a DECT phone device dataset.

Devices cannot be created separately. They are created automatically during subscription (unbound) or they are created fixed bound to a user when a user is created in the **Overview** submenu.

Configuration	Device ID	IPEI	DECT Auth. co...	Encryption	Device rel. type	Rel. user ID	Subscribed	Tasks
Status	0x001	10345 0031639 *		✓	Fixed	0x001	✓	<ul style="list-style-type: none"> <li>Configure</li> <li>Delete</li> <li>Filter</li> <li>Subscription</li> <li>Wildcard subscription</li> <li>Select columns</li> </ul>
	0x002	03586 0952116 0		✓	Fixed	0x002	✓	
System	0x003	03586 0950946 7	2222	✓	Fixed	0x003	✓	
	0x004	03586 0952129 3		✓	Fixed	0x004	✓	
Sites	0x05F	00100 0000000 3		✗	Fixed	0x04C	✗	
DECT base stations	0x060	00100 0000001 4		✗	Fixed	0x04D	✗	
	0x061	00100 0000002 5		✗	Fixed	0x04E	✗	
WLAN	0x062	00100 0000003 6		✗	Fixed	0x04F	✗	
	0x063	00100 0000004 7		✗	Fixed	0x050	✗	
Video devices	0x064	00100 0000005 8		✗	Fixed	0x051	✗	
DECT phones	0x065	00100 0000006 9		✗	Fixed	0x052	✗	
	0x066	00100 0000007 *		✗	Fixed	0x053	✗	
Overview	0x067	00100 0000008 0		✗	Fixed	0x054	✗	
	0x068	00100 0000009 1		✗	Fixed	0x055	✗	
Users	0x069	00100 0000010 3		✗	Fixed	0x056	✗	
Devices	0x06A	00100 0000011 4		✗	Fixed	0x057	✗	
	0x06B	00100 0000012 5		✗	Fixed	0x058	✗	
Conference rooms	0x06C	00100 0000013 6		✗	Fixed	0x059	✗	
	0x06D	00100 0000014 7		✗	Fixed	0x05A	✗	
System features	0x06E	00100 0000015 8		✗	Fixed	0x05B	✗	
	0x06F	00100 0000016 9		✗	Fixed	0x05C	✗	
Licenses	0x070	00100 0000017 *		✗	Fixed	0x05D	✗	
	0x071	00100 0000018 0		✗	Fixed	0x05E	✗	
	0x072	00100 0000019 3		✗	Fixed	0x05F	✗	
	0x073	00100 0000020 3		✗	Fixed	0x060	✗	

**Note:** Use the **Select columns** dialog (see section 6.10.9) to display the desired DECT phone device data.

The following tasks can be performed:

- **Configure:** configure selected DECT phone device dataset (see section 6.10.6).
- **Delete:** delete selected DECT phone device dataset (see section 6.10.8).
- **Subscription:** start DECT phone subscription (see section 6.10.7).
- **Wildcard subscription:** start DECT phone wildcard subscription (see section 6.10.7).
- **Select columns:** select parameter columns to be shown in table (see section 6.10.9).
- **Filter:** filter DECT phone datasets shown in table for string set in filter mask (see section 6.10.10).

#### 6.10.4 DEVICE DETAIL PANEL

The **Device detail** panel is used for configuration/showing of device settings and creation of new DECT phone datasets.

To open the **Device detail** panel

- choose one of the commands in the task bar on the right of the **DECT Phones** panel (**Configure**) or
- double-click on the appropriate device entry in the device table

The **Device detail** panel contains the different parameter groups sorted in tabs. The tabs displayed depend on the current mode and the panel from which the DECT phone detail panel was invoked.

- **Overview** panel (configuration and monitor mode): The DECT phone detail panel contains all tabs listed below.
- **User** panel (configuration mode): The DECT phone detail panel contains all tabs but not **DECT**.
- **Device** panel (configuration mode): The DECT phone detail panel contains only **DECT**.

### 6.10.4.1 “General” tab

This tab configures the general settings for the DECT phone dataset.

The screenshot shows a configuration window with the following elements:

- Top tabs: Messaging, Locating, Additional services, Configuration data, User service.
- Sub-tabs: General (selected), SIP, Incoming calls, Conference.
- Fields:
  - Name:
  - Number/ SIP user name:
  - Description 1:
  - Description 2:
  - Login/Additional ID:
  - PIN:
  - PIN confirmation:
- Buttons: OK, Cancel.

- **Name:** the DECT phone user name (up to 20 characters).
- **Number:** the DECT phone telephone number, up to 31 characters (1234567890\*#azAz+\_.!\$%&/()=?\$&). Please be aware that only “\*”, “#” and “0” to “9” can be dialed with a DECT phone.
- **Description 1** and **Description 2:** free text comments with up to 16 characters each.
- **Login/Additional ID:** The additional ID can be used as a mean for data search within wildcard subscription (because of the IPEI is not configured which selects the data otherwise).
- **PIN, PIN confirmation:** A user PIN to be entered during user login.

**Note:** The attempt to set the user PIN to an empty string sets the PIN to the default value “0000”.

### 6.10.4.2 “SIP” tab

This tab configures the SIP authentication for the DECT phone dataset.

The screenshot shows a configuration window with the following elements:

- Top tabs: Messaging, Locating, Additional services, Configuration data, User service.
- Sub-tabs: General, SIP (selected), Incoming calls, Conference.
- Fields:
  - Authentication user name:
  - Password:
  - Password confirmation:
  - VIP:
  - Used for visibility checks:
  - Fixed port:
  - Calculated port:
- Buttons: OK, Cancel.

- **Authentication user name:** The SIP Authentication user name is optional but recommended. It represents the name which will be used during SIP registration and authentication. If no name is given the number will be used by default.
- **Password, Password confirmation:** The password will be used during SIP registration and authentication. Enter the appropriate data in these fields.
- **VIP:** Enable this option if the registration of this user should be prioritized (default off). VIP users will be registered first. For more information on prioritized registration see section 7.20.5.
- **Used for visibility checks:** Enables the use of this user account to check the availability of the iPBX (e.g., in fail over situations). See section 7.20.7 for more information on this feature.
- **Fixed port:** Specifies the port used explicitly for SIP signaling. If set to 0, an automatically calculated port is used. The default is 0. See section 3.17 for more information on this feature.

#### 6.10.4.3 "Incoming calls" tab

This tab allows you to set device-specific settings for auto-answering incoming calls. Default values for all parameters are inherited from global settings (see section 6.5.4.7).

Messaging	Locating	Additional services	Configuration data	User service
General	SIP	Incoming calls		Conference
Auto answer	Global			
Microphone mute	Global			
Warning tone	Global			
Allow barge in	Global			

OK Cancel

- **Auto answer:** Enables or disables auto-answer on incoming calls.
- **Microphone mute:** Enables or disables microphone muting when incoming calls are automatically answered.
- **Warning tone:** Enables or disables warning tone on incoming call. A short ringtone is played if there are no active calls. If there is an active call in a "barge in" situation, the ringing will be in-band
- **Allow barge in:** Allows/disallows "barge-in" on existing calls.

#### 6.10.4.4 “Conference” tab

This tab configures the three-way conferencing for the DECT phone dataset individually.

The screenshot displays the configuration interface for the 'Conference' tab. The top navigation bar includes 'Messaging', 'Locating', 'Additional services', 'Configuration data', and 'User service'. The 'Additional services' section is expanded to show 'General', 'SIP', 'Incoming calls', and 'Conference'. The 'Server type' dropdown menu is currently set to 'Global'. Below it, the 'URL' field is an empty text box. At the bottom of the interface, there are two buttons: 'OK' and 'Cancel'.

- **Server type:** Determines the conference service to be used for three-way conferencing. Possible values are:
  - **None:** Disables 3-way conferencing.
  - **Global:** The OMM system setting is used (default).
  - **Integrated:** The integrated conference server is used.
  - **External:** An external conference server is used.
  - **External – Blind Transfer:** an external conference server is used (e.g., MiVoice Business). The initiation of the conference is signaled as a blind transfer to the destination specified in the URL parameter.
- **URL:** Address of an external conference server (field only activated if the server type is “External”)

For more information see section 7.20.7.

#### 6.10.4.5 “DECT” tab

This tab configures the DECT part for the DECT phone dataset. When configuring a device (see 6.10.3), only the **DECT** tab is shown in the DECT phone detail panel.



Device #0x002 - User #0x002

Locating	Additional services	User monitoring	Configuration data
General	SIP	Incoming calls	Conference
		DECT	Messaging

IPEI

DECT authentication code

Encryption

Subscribe to PARI only

Delete subscription

- **IPEI:** This optional setting is the DECT phone IPEI number. On a Mitel DECT 142 / Mitel 142d DECT phone, the IPEI can be found via the following path of the device menu: **Main menu > Phone settings > System**. On a Mitel 600 DECT phone, the IPEI can be found in the **System** device menu. Consult the DECT phone's user guide for further information.
- **DECT authentication code:** The DECT authentication code is used during initial DECT subscription as a security option and can be set here for each DECT phone device separately (DECT phone-specific DECT authentication code). If no DECT phone-specific DECT authentication code is set, the system-wide DECT authentication code is used.
- **Encryption:** If the encryption feature is enabled for the whole system (in the **System settings** menu, see section 6.5.1), you can de-activate the DECT encryption for this device.

**Please note:** The DECT phone device must support DECT encryption which is not a mandatory feature.

- **Subscribe to PARI only:** Ensures that the DECT phone subscribes to the PARK code (of a single OMM, within a Dual Homing installation) and not to the SARI. This option is only available for fixed user device pairs, and must be set before subscription takes place. For this reason, you should set the parameter immediately when creating the DECT phone device.
- **Delete subscription:** This option is only available when configuring an existing DECT phone. If this option is activated, the subscription data will be deleted which also requires a re-subscription of the DECT phone device.

#### 6.10.4.6 "Messaging" tab

This tab configures the OM Integrated Messaging and Alerting service for the DECT phone dataset. If a user is created independent of any specific configuration, the **Sending messages** and **Sending vCards** features are enabled by default.

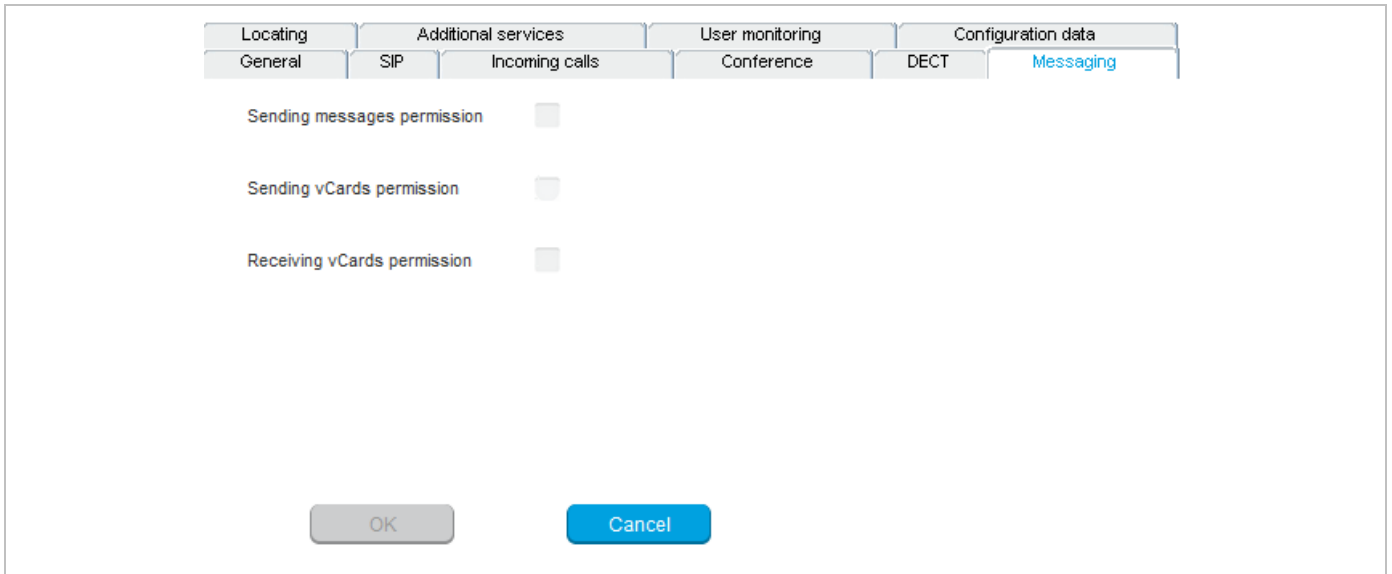

- **Sending messages permission:** If this option is enabled, the DECT phone can send messages (if this function is supported by the device).

**Note:** For further information see the document SIP-DECT OM Integrated Messaging & Alerting Application Installation, Administration & User Guide.

- **Sending vCards permission:** Allows the user to send personal directory entries as a vCard message from the DECT phone to other users (if this function is supported by the device).
- **Receiving vCards permission:** If this option is enabled, all received vCard messages are automatically processed and written into the personal directory of the DECT phone (if this function is supported by the device).

#### 6.10.4.7 "Locating" tab

This tab contains parameters for configuring location parameters for the DECT phone.

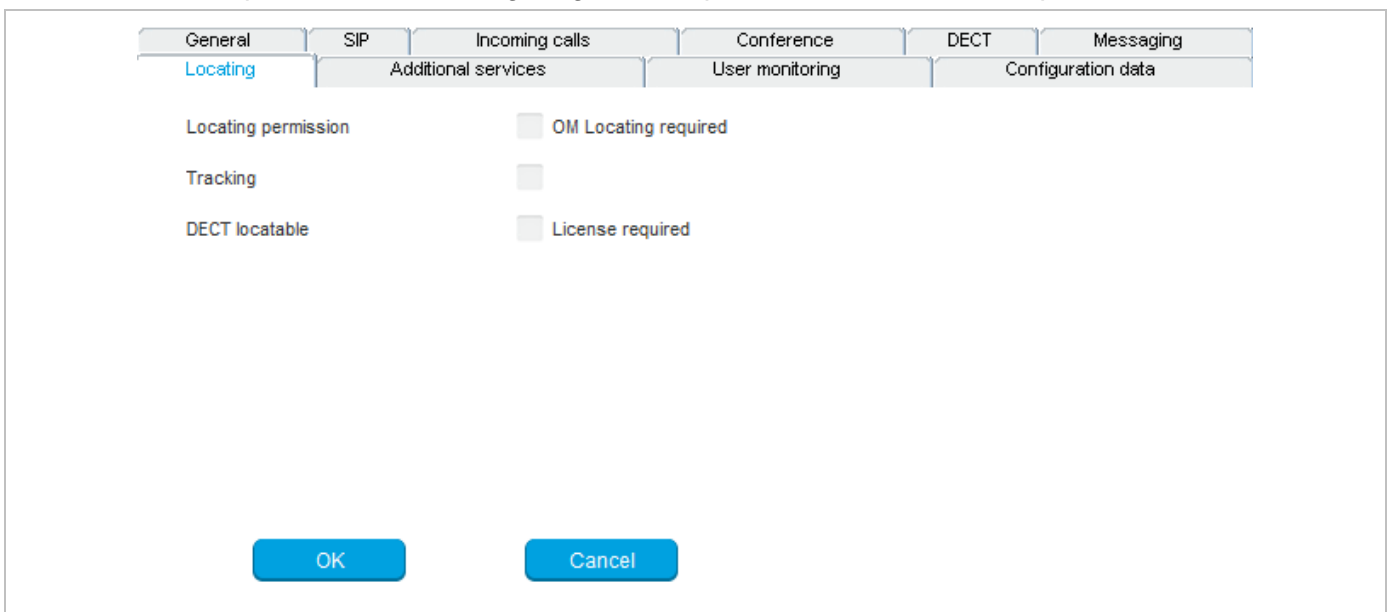

- **Locating permission:** This option applies to Mitel 600 DECT phones only. If this option is enabled, the user is allowed to determine the location of other DECT phones. The main menu of the Mitel 600 DECT phones provides an extra **Locating** menu entry for this function.
- **Tracking:** If this option is enabled, the operator of the OM Locating application is able to use the constant tracking feature for the DECT phone. Note that this feature consumes more of the DECT phone's battery power, because it activates a DECT base station update if the device roams and is not in communication. You also cannot enable this feature, if the **DECT locatable** option is disabled
- **DECT locatable:** If this option is enabled, the DECT phone is locatable. Either with the OM Locating application or by querying it's location from other DECT phones.

#### 6.10.4.8 “Additional services” tab

This tab configures extra configuration items for the DECT phone dataset.

The screenshot displays the 'Additional services' configuration tab. The top navigation bar includes 'General', 'SIP', 'Incoming calls', 'Conference', and 'Messaging'. The 'Additional services' tab is active. Below the navigation, there are four main sections: 'Locating', 'Additional services', 'Configuration data', and 'User service'. The 'Additional services' section contains the following fields and options:

- SOS number:** A text input field.
- ManDown number:** A text input field.
- Voice mail number:** A text input field.
- Keep personal directory:** A toggle switch (currently off).
- External:** A toggle switch (currently off).
- Hot desking supported:** A toggle switch (currently off).
- Auto logout on charging:** A toggle switch (currently off).

At the bottom of the form, there are two buttons: 'OK' and 'Cancel'.

- **SOS number:** User-specific SOS number that is dialed automatically if the SOS key on the DECT phone is pressed.
- **ManDown number:** User specific “Man down” number that is dialed automatically if a Man down event happens. This event is triggered by the sensor of a Mitel 600 DECT phone.  
If no individual SOS or Man down number is configured for a DECT phone, the number of the appropriate alarm trigger will be used as calling number in case of a SOS or Man down event. Please see /31/ for details.
- **Voice mail number:** The number that will be automatically called as soon as a voice mail call is initiated on the Mitel 600 DECT phone. If there is no individual voice mail number configured in this field, then the system-wide voice mail number is used (see also the **System setting** menu, section 6.5.1). If there is no voice mail number configured (neither the individual nor the system-wide) or another DECT phone type is used, then the voice mail number must be configured locally in the DECT phone.
- **Keep personal directory:** Activate this option, to keep the personal directory data in the DECT phone if the user logs out.

- **External:** A user data set can either be provisioned on an external user data server or locally in the OMM database. To provide an easy way to change the provisioning storage of user data sets, the user data sets can be moved from an external user data server into the local OMM database and vice versa.

Deactivate the **External** option if you want to move user data sets from an external user data server into the local OMM database.

**External to internal transformation rules:** To change a user data set from an external user data server to an internally provisioned one, the following conditions must be applied to the data set:

- external provisioned on an external user data server
- user data set device relation must not be “fixed”

**Internal to external transformation rules:** To change a user data set from local OMM database to an external user data server provisioned one the following conditions must be applied for the data set:

- external provisioned on an external server
- user data set device relation must not be “fixed”
- an external user data server must be available

- **Video stream permission:** Activate this option to allow video streaming on the Mitel 602 DECT phone. See section 7.28 for details on this feature.
- **Hot desking supported:** enables or disables Hot desking functionality (for SIP-DECT systems using the MiVoice Business platform). Only available for users with a dynamic association with a DECT phone. When enabled, the user is registered as a Hot Desking user on the MiVoice Business call server. See section 3.14 for details on this feature.
- **Auto logout on charging:** enables or disables automatic user log out on the DECT phone when the device is placed in the charger cradle. Only available for users with a dynamic association with a DECT phone. Note that the **Silent charging** option must be enabled on the DECT phone.

#### 6.10.4.9 “User monitoring” tab

This tab is designed to configure the user-specific parameters for the User Monitoring feature. For a description of the parameters which can be set in the **User monitoring** tab, see the description in section 7.29.7.2.

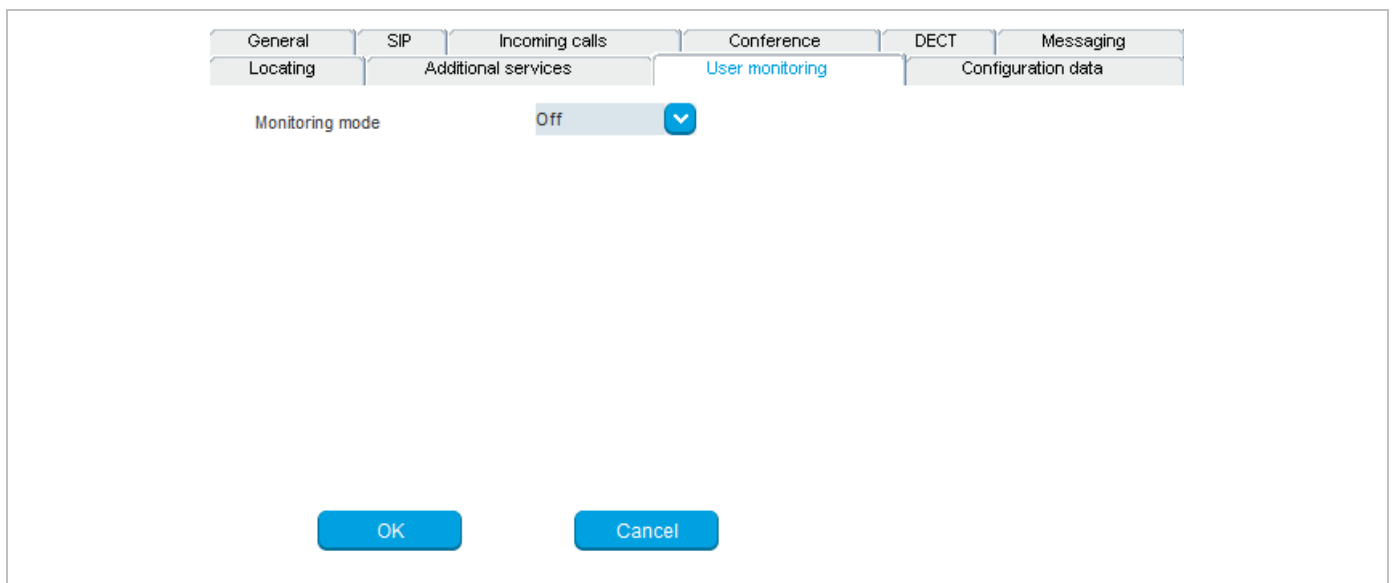

#### 6.10.4.10 “Configuration data” tab

The **Configuration data** tab allows you to assign a Configuration over Air (CoA) profile to a DECT phone user. See section 7.23 for more information on this feature.

- **Profile id:** Specifies the CoA configuration profile you want to assign to the DECT phone user.

**Note:** When a COA profile is deleted, its profile ID assignment to DECT phone users remains. If a new CoA profile is created and acquires this profile ID (the IDs are assigned in sequential order), any DECT phone users with the old profile ID are automatically assigned to the new CoA profile.

If you do not want the DECT phone users to automatically inherit any new CoA profile that has the profile ID, you must remove the profile ID assignment manually.

#### 6.10.4.11 “User service” tab

The **User service** tab allows you to specify parameters related to user authentication for XSI services.

- **Use SIP user name:** Specifies whether the XSI user name is taken from the user's SIP data. The generated format is <sip user name>@<sip registrar domain>. Possible values are **Global**, **On**, or **Off**.
- **Use SIP user authentication:** Specifies whether the XSI authentication name and password are taken from user's SIP data. The generated format is <sip authentication name>@<sip registrar domain>. Possible values are **Global**, **On**, or **Off**.
- **User name:** Specifies the user's user name for the XSI service (if **Use SIP user name** is set to Off). The username is part of the access url path of a XSI request (e.g., /com.broadsoft.xsi-actions/v2.0/user/<service user name>/directories/Enterprise?firstName=A\*).
- **Authentication name:** Specifies the name to authenticate the user for XSI services (if **Use SIP user authentication** is set to Off).
- **Password:** Specifies the password to authenticate the user for XSI services.
- **Password confirmation:** confirms the password to authenticate the user for XSI services.

### 6.10.5 CREATING DECT PHONE DATASETS

Creating DECT phone datasets is only possible in Configuration Mode. You can create the fixed DECT phone dataset or only the DECT phone user data.

To create a DECT phone dataset, do the following:

- 1 Click **Create** under the Task list on the right-hand side of the **DECT Phones** window.
  - In the **Overview** submenu you can create a fixed DECT phone dataset (with combined user and device data).
  - In the **Users** submenu you can create an unbound user. This user can login and log out on any configured device.The DECT phone detail panel opens and provides tabs where the DECT phone data must be entered.
- 2 Configure the DECT phone, see parameter description in section 6.10.4.
- 3 Press the **OK** button.

### 6.10.6 CONFIGURING DECT PHONE DATASETS

Configuring DECT phone datasets is only possible in Configuration Mode. To configure an existing DECT phone dataset proceed as follows:

- 1 Select a DECT Phone from the table, and click **Configure** under the Task list on the right-hand side of the **DECT Phones** window.
  - In the **Overview** submenu you can configure the whole DECT phone dataset (user and device data).
  - In the **Users** submenu you can configure the DECT phone user data.
  - In the **Device** submenu you can configure the DECT phone device data.The DECT phone detail panel opens.
- 2 Change the DECT phone dataset as desired, see parameter description in section 6.10.4.
- 3 Press the **OK** button.

### 6.10.7 SUBSCRIBING DECT PHONE DATASETS

After adding a DECT phone dataset to the OMM, the DECT phone must be subscribed. The OMM must first be enabled to allow subscriptions from DECT phones. Subscribing DECT phone datasets is possible in the **Overview** panel and in the **Device** panel. To start subscription, press one of the following commands in the **DECT phones** menu:

- **Subscription:** start DECT phone subscription with configured IPEI. For more information on this see section 5.7.3.1.
- **Wildcard subscription:** start DECT phone wildcard subscription (without configured IPEI). In the **Wildcard subscription** dialog, which is now opened, enter the **Timeout** for this subscription method. Press the **Start** button. For more information on this see section 5.7.3.2.

### 6.10.8 DELETING DECT PHONE DATASETS

Deleting DECT phone datasets is only possible in **configuration mode**. You can delete the fixed DECT phone dataset (in case of fixed relation) or only the DECT phone user data resp. the DECT phone device data (in case of dynamic relation).

To delete one or more existing DECT phone datasets proceed as follows:

- 1 Select the appropriate DECT phone dataset(s) in the DECT phone table by activating the corresponding checkbox(es).
- 2 In the task bar on the right of the **DECT phones** panel click on the **Delete** command.
  - In the **Overview** submenu the whole DECT phone dataset will be deleted.
  - In the **Users** submenu only the DECT phone user data will be deleted.
  - In the **Devices** submenu only the DECT phone device data will be deleted.The **Delete [xxx]** dialog opens showing a confirmation prompt.
- 3 Confirm the displayed prompt with **OK**.

### 6.10.9 SELECTING COLUMNS

You can adapt the parameters shown in the DECT phone table to your needs:

- 1 Click **Select columns** under the Task list on the right-hand side of the **DECT Phones** window. The **Select columns** dialog opens.
- 2 Select the columns that shall be shown by activating the appropriate checkboxes.
- 3 Click the **OK** button.
- 4 The DECT phone table will be adapted accordingly.

### 6.10.10 FILTERING DECT PHONE TABLE

You can filter the list of DECT phone datasets shown in the DECT phone table by using a filter.

- 1 Click **Filter** under the Task list on the right-hand side of the **DECT Phones** window. The **Filter** dialog opens.
- 2 Enter the search string that serves as filter criterion. You can enter digits and characters. The search is case sensitive.
- 3 Click on the **Filter** button.

The **Filter** dialog is closed and the DECT phone table will be adapted accordingly.

- 4 To reset the filter, click on the **Filter** command in the task bar on the right of the **DECT phones** panel.
- 5 In the **Filter** dialog click on the **Reset** button.

### 6.10.11 CHANGING THE RELATION TYPE

A user data-device relation data set can be changed from “fixed” to “dynamic” and vice versa. This means the login/logout feature can be enabled or disabled for a DECT phone. The user data device relation can only be changed by the admin user.

To change the relation type of a DECT phone:

- 1 Select the appropriate DECT phone dataset(s) in the DECT phone table by activating the corresponding checkbox(es).
- 2 Click **Change rel. type** under the Task list on the right-hand side of the **DECT Phones** window.

#### Rules to change the relation from “fixed” to “dynamic”

- The DECT phone must be subscribed.
- A user login/logout PIN is configured in the user data set.
- Depending on the DECT phone user login type (“LoginID”), in the **DECT** tab of the **System settings** menu, the **Login ID** option must be set in the **DECT phone user login type** field.

**IMPORTANT :** If there is no specific PIN configured then “0000” is automatically set.

#### Rules to change the relation from “dynamic” to “fixed”

- The user relation type must be “Dynamic” (not “Unbound”), because a subscribed DECT phone exists in this case.
- The user data set is not retrieved from an external user data server / the user data set is provisioned locally in the OMM database (see also page 196).

### 6.10.12 ENABLING / DISABLING DECT PHONE EVENT LOG

You can store a DECT phone event log file in **Monitor Mode**. Do the following:

- 1 To enable/disable the DECT phone event log, click **Log events** under the Task list on the right-hand side of the **DECT Phones** window:
  - ✓ - DECT phone event log is enabled.
  - ✗ - DECT phone event log is disabled.
- 2 Repeat step 1 to disable/enable the DECT phone event log.

The DECT phone event log will be stored in a file called “pp\_event.log“. This file can be found in the user’s home directory:

- on a Linux system it is located under ‘~/oamp’,
- on a windows system under ‘c:/Users/<user>/MyDocuments/.Oamp’.



### 6.10.13 USER MONITORING

User monitoring menu available in monitoring mode only a list of the DECT Phone users who are configured for user monitoring.

The following parameters are displayed for each DECT Phone user:

- User ID
- Name
- Number
- Related device ID
- Mode: User monitoring mode (active or passive)
- Combined User Status (CUS)
- Handset Assignment Status (HAS) (Dynamic User logged on)
- Handset Subscription Status (HSS) (DECT subscribed)
- Handset registration status (HRS) (DECT attached)
- Handset activity status (HCS) (Handset active within time period)
- SIP user registration status (SRS) (SIP user registered)
- Silent charging status (SCS) (Silent charging + Charger)
- Call diversion status (CDS) (immediate call diversion enabled)
- Handset battery status (HBS) (Battery power above limit, warn only)
- Software status (SWS) (minimal required software version, warn only)

Monitoring parameter can have these values:

-  - Available
-  - Warning
-  - Unavailable
-  - Escalated

## 6.11 “CONFERENCE ROOMS” MENU

On this menu page you managed individual conference rooms for the Integrated Conference Server (ICS). For details on how to configure the conferencing feature refer to section 7.20.7.

The tasks which can be performed are mode-dependant.

Configuration mode	Monitor mode	See section
<b>Create:</b> create conference room		6.11.1
<b>Configure:</b> configure selected conference room		6.11.2
	<b>Show details:</b> show details about a selected conference room	6.11.4
<b>Delete:</b> delete selected conference room		6.11.3

### 6.11.1 CREATING CONFERENCE ROOMS

In **Configuration Mode** you can create new conference rooms. Conference rooms will be registered on the configured SIP registrar, thus you must enter the SIP account data to be used.

- 1 Click **Create** in the **Tasks** menu of the **Conference rooms** page.
- 2 In the **General** tab, enter the conference room parameters.
  - **Name:** Enter the SIP display name for the SIP account to be used.
  - **Conference ID:** Enter the SIP user id.
  - **User name:** Enter the SIP authentication name.
  - **Password, Password confirmation:** Enter the password that is required by the SIP server.
  - **Fixed SIP port:** Enter the port used explicitly for SIP signaling. If set to 0, an automatically calculated port is used for this conference room. The default is 0. See section 3.17 for more information on this feature.
- 3 Click **OK**.

### 6.11.2 CONFIGURING CONFERENCE ROOMS

In **Configuration Mode** you can configure an existing conference room.

- 1 Select the appropriate conference room entry in the conference rooms table.
- 2 Click **Configure**.

The **General** tab is displayed showing the current conference room configuration.
- 3 Change the conference room parameters as required.
- 4 Click **OK**.

### 6.11.3 DELETING CONFERENCE ROOMS

In **Configuration Mode**, you can delete conference rooms.

- 1 Select one or more conference rooms entries in the conference rooms table.
- 2 Click **Delete**.

A confirmation dialog appears.
- 3 Click **OK** to confirm.

### 6.11.4 VIEWING CONFERENCE ROOM DETAILS

In **Monitor Mode**, you can view the details of a conference room.

- 1 Select the appropriate conference room entry in the conference room table.
- 2 Click **Show details**.

The **General** tab is displayed showing the conference room configuration.
- 3 Click **Cancel** to close the tab.

## 6.12 “SYSTEM FEATURES” MENU

The **System features** menu provides the following entries:

Configuration mode	Monitor mode	See section
General settings	General settings	0
Feature access codes	Feature access codes	0
Alarm triggers	Alarm triggers	6.12.3
Digit treatment	Digit treatment	6.12.4
Directory	Directory	6.12.5.1
XML applications	XML applications	6.12.7
CoA profiles	CoA profiles	6.12.8

### 6.12.1 “GENERAL SETTINGS” MENU

The **General settings** menu allows to configure/view the FAC number prefix used for feature access codes and alarm triggers.

The screenshot displays the configuration interface for the 'General' settings. On the left, a navigation menu lists various system features, with 'General settings' selected under the 'System features' category. The main content area shows a 'General' tab with a text input field for 'FAC number and prefix for alarm triggers'. Below the input field are two buttons: 'OK' and 'Cancel'.

- 1 **FAC number and prefix for alarm triggers:** Enter a unique FAC number.
- 2 Press the **OK** button.

### 6.12.2 “FEATURE ACCESS CODES” MENU

The **Feature access codes** menu is used to configure/view the feature access codes parameters.

The **FAC number** which introduces the feature access code (see also section 0) is displayed. For a description of the parameters which can be set in this menu see section 5.9.4.

### 6.12.3 “ALARM TRIGGERS” MENU

The **Alarm triggers** menu allows configuration and display of numerous alarm trigger datasets. There are two predefined alarm triggers (“SOS” and “MANDOWN”) which cannot be deleted.

ID	Trigger ID	Feature access code	Comment	Number
0	SOS	SOS		
1	MANDOWN	MANDOWN		

**Alarm trigger #0**

General

Trigger ID: SOS

Feature access code: SOS

Comment:

Prefix:

Number:

Tasks: Create, Configure, Delete

The tasks which can be performed are mode-dependant.

Configuration mode	Monitor mode	See section
<b>Create:</b> create alarm trigger		6.12.3.1
<b>Configure:</b> configure a selected alarm trigger		6.12.3.2
	<b>Show details:</b> show parameters of a selected alarm trigger	6.12.3.4
<b>Delete:</b> delete selected alarm triggers		6.12.3.3

### 6.12.3.1 Creating “Alarm triggers”

In **Configuration Mode** you can create new alarm triggers.

The screenshot shows a 'New alarm trigger' dialog box with the following fields and buttons:

- Trigger ID:** A text input field.
- Feature access code:** A text input field.
- Comment:** A text input field.
- Prefix:** A text input field.
- Number:** A text input field.
- Buttons:** 'OK' (grey) and 'Cancel' (blue).

- 1 Click **Create**. In the **General** tab enter the alarm trigger parameters.
- 2 **Trigger ID:** Enter the AlarmTrigger ID that the OMM sends to identify the alarm scenario and the source that triggers the alarm.
- 3 **Feature access code:** Enter the feature access code that the user dials to initiate the alarm.
- 4 **Comment:** Enter a comment for the new trigger.
- 5 **Prefix:** This field displays the **FAC number** which introduces the feature access code (see also section 0).
- 6 **Number:** Enter the number to be called if the user triggers the alarm by dialing the feature access code. If no number is specified, the call is released.
- 7 Press the **OK** button.

### 6.12.3.2 Configuring “Alarm triggers”

In **Configuration Mode** you can configure an existing alarm trigger.

- 1 In the alarm trigger table click on the appropriate trigger entry.
- 2 Click **Configure**.  
The **General** tab is displayed showing the current trigger configuration.
- 3 Change the trigger parameters.

4 Press the **OK** button.

### 6.12.3.3 Deleting “Alarm triggers”

In **Configuration mode** you can delete alarm triggers. The predefined alarm triggers (‘SOS and ‘Man down’) cannot be deleted.

- 1 In the alarm trigger table click on one or more trigger entries.
- 2 Click **Delete**.
- 3 Confirm the displayed prompt with **OK**.

### 6.12.3.4 View “Alarm trigger” Details

In **Monitor Mode** you can view the details of an alarm trigger.

- 1 In the alarm trigger table click on the appropriate trigger entry.
- 2 Click **Show details**.  
The **General** tab is displayed showing the trigger configuration.
- 3 Click **Cancel** to close the tab.

## 6.12.4 “DIGIT TREATMENT” MENU

The **Digit treatment** menu allows you to configure the number manipulation that is provided by the digit treatment feature for LDAP corporate directories.

The screenshot displays the 'New digit treatment entry' dialog box in the OM Management Portal. The dialog is titled 'New digit treatment entry' and has a 'General' tab selected. The fields are as follows:

- External pattern:** An empty text input field.
- Internal pattern:** An empty text input field.
- Direction:** A dropdown menu set to 'Incoming and outgoing calls'.
- Apply to directory:** An unchecked checkbox.
- Sites:** A dropdown menu set to 'All'.

At the bottom of the dialog are three buttons: 'OK' (disabled), 'Cancel', and 'Select'.

The background interface shows a configuration menu on the left with options like 'Configuration', 'Status', 'System', 'Sites', 'DECT base stations', 'WLAN', 'Video devices', 'DECT phones', 'Conference rooms', 'System features', 'General settings', 'Feature access codes', 'Alarm triggers', 'Digit treatment' (highlighted), 'Directory', 'XML applications', 'CoA profiles', and 'Licenses'. On the right, there is a 'Tasks' panel with 'Create', 'Configure', and 'Delete' options.

For a description of tasks and parameters available in this menu, refer to section 5.9.1.

## 6.12.5 “DIRECTORY” MENU

The **Directory** menu allows configuration of LDAP, XML or XSI -based corporate directory services.

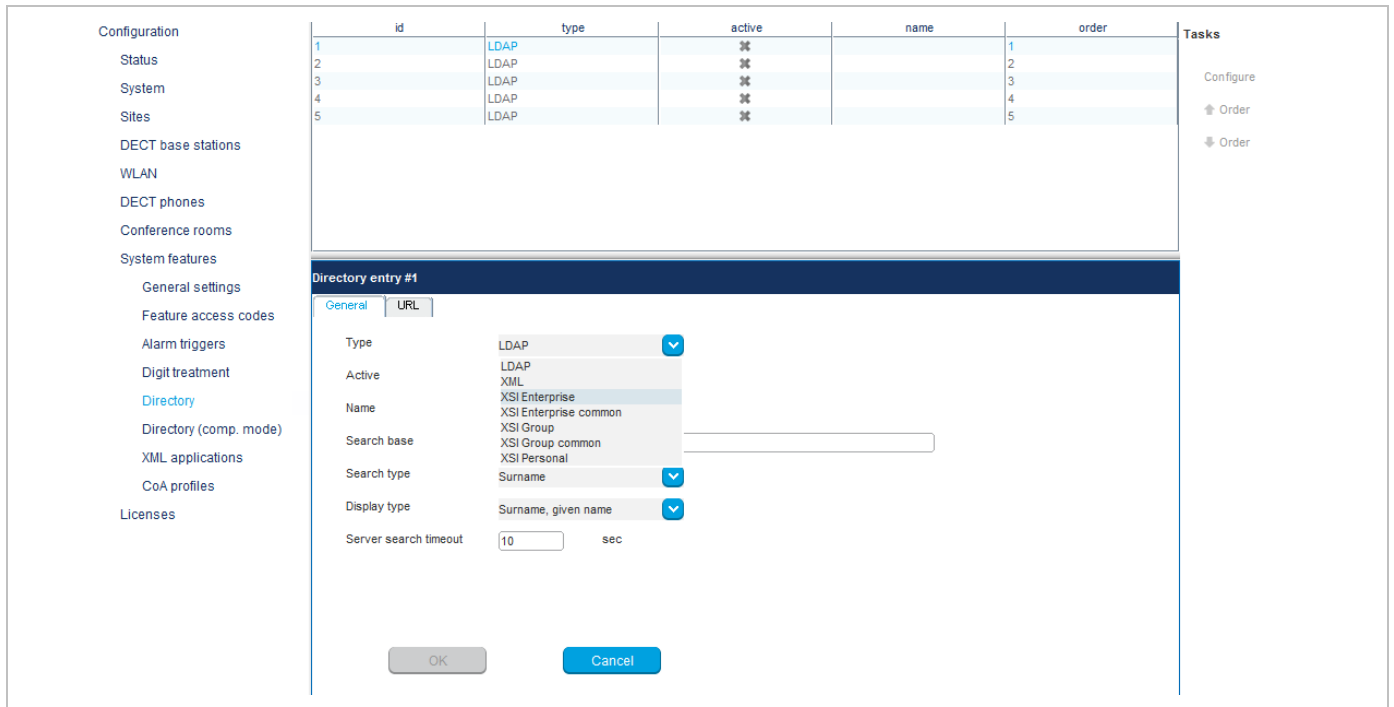

The tasks which can be performed are mode-dependant.

Configuration mode	Monitor mode	See section
<b>Create:</b> create new directory entry in detail panel		6.12.5.1
<b>Configure:</b> configure selected directory entry in detail panel		6.12.5.2
	<b>Show details:</b> show selected directory entry in detail panel	6.12.5.3
<b>Delete:</b> delete selected directory entry/entries		6.12.5.4

### 6.12.5.1 Creating New Directory Entries

Adding directory entries is only possible in **configuration mode**. You can configure up to five directory entries. To add a new entry, do the following:

- 1 In the **Tasks** panel, click **Create**.

The **New directory entry** panel opens and provides various tabs where the directory data must be entered.

- 2 Configure the directory entry (see parameter descriptions below).
- 3 Click **OK** to save your changes.



You can specify values for the following parameters in the **New directory entry** panel:

**General tab**

The following table describes the parameters on the General tab and to which directory type they apply.

Parameter	Description	LDAP	XML	XSI
<b>Type</b>	Interface type supported by the directory server. Possible values: <ul style="list-style-type: none"> <li>• LDAP</li> <li>• XML</li> <li>• XSI Enterprise</li> <li>• XSI Enterprise common</li> <li>• XSI Group</li> <li>• XSI Group common</li> <li>• XSI Personal</li> </ul>	✓	✓	✓
<b>Active</b>	Enables or disables the directory entry on the DECT phone.	✓	✓	✓
<b>Name</b>	Name to be displayed for the directory (Latin-1 character set is supported). <b>Note:</b> If there is only one directory entry configured, this value is ignored when the user searches for a number in the telephone’s central directory. SIP-DECT 6.0 and later supports the “SIPProxy” placeholder for a directory entry name, in place of the current primary, secondary or tertiary SIP server address.	✓	✓	✓
<b>Search base</b>	Location in the LDAP directory from which the search begins (e.g., “ou=people, o=my com”). The configuration is valid for all DECT phones that support the LDAP directory feature. To make search requests unique for different users, the search base configuration can include placeholders that are replaced by user-specific values when submitting the LDAP request to a server. The following placeholders are defined: <ul style="list-style-type: none"> <li>• “&lt;TEL&gt;” (for the user’s telephone number)</li> <li>• “&lt;DESC1&gt;” (for the user’s “Description 1” attribute)</li> <li>• “&lt;DESC2&gt;” (for the user’s “Description 2” attribute)</li> <li>• “SIPProxy” (for the current primary, secondary or tertiary SIP server address); supported for release 6.1 and later</li> </ul>	✓		
<b>Search type</b>	Attribute on which searches are performed ( <b>Surname</b> or <b>Given name</b> ).	✓		✓
<b>Display type</b>	Display mode for search results ( <b>Surname</b> , <b>First Name</b> or <b>Given name Surname</b> ).	✓		✓
<b>Server search timeout</b>	Interval (in seconds) during which the OMM waits for search results from the LDAP server (1 – 99 seconds).	✓		

## URL tab

The following table describes the parameters on the **URL** tab and to which directory type they apply.

Parameter	Description	LDAP	XML	XSI
<b>Protocol</b>	Transfer protocol used to communicate with the XML or XSI directory server ( <b>http</b> or <b>https</b> ).		✓	✓
<b>Port</b>	Server port number. Specify a value, or enable the <b>Use default port</b> flag. For LDAP, the default is 389. SSL (default port 689) is not supported. Windows Active Directory Server uses port 3268. For XML or XSI, the default is 80 for HTTP, and 443 for HTTPS.	✓	✓	✓
<b>Server</b>	IP address or FQDN of the directory server.	✓	✓	✓
<b>User name</b>	Name of the account for directory server access, if required.	✓	✓	
<b>Password</b>	Password for directory server access, if required. Confirm the password in the next field. <b>Note:</b> If no user/password is specified, an anonymous bind takes place. SIP-DECT supports LDAP simple bind.	✓	✓	
<b>Path (and parameters)</b>	URL (with parameters, if required) to the XML directory on the XML directory server.		✓	
<b>Use common certificate configuration</b>	Enables or disables use of the system's certificates (loaded for provisioning purposes) for HTTPS directory access.		✓	✓

### 6.12.5.2 Changing a Directory Entry

Changing directory entry is only possible in configuration mode. To change the configuration of an existing directory entry, do the following:

- 1 Select the appropriate directory entry in the table.
- 2 Click **Configure** in the **Tasks** panel.
- 3 Change the directory entry parameters as required (see parameter descriptions in section 6.12.5.1).
- 4 Click **OK**.

### 6.12.5.3 Viewing Directory Entry Details

You can view the configuration of a directory in **Monitor Mode**. Do the following:

- 1 Select the appropriate directory entry in the table.
- 2 In the **Tasks** bar click **Show details**.  
The directory entry data is displayed in the detail panel.
- 3 Click **Cancel** to close the directory entry detail panel.

### 6.12.5.4 Deleting Directory Entries

Deleting directory entries is only possible in **Configuration Mode**. To delete one or more existing entries, do the following:

- 1 Select the appropriate entry/entries in the directory entry table by activating the corresponding checkbox(es).
- 2 In the **Tasks** pane, click **Delete**.  
A confirmation dialog opens.

3 Click **OK** to confirm.

### 6.12.6 “DIRECTORY (COMP. MODE)” MENU

With the introduction of XSI directory support in SIP-DECT 6.2, the underlying database model for directory support in SIP-DECT has changed. To support backwards compatibility, the Directory (comp) page provides directory configuration and maintenance for existing SIP-DECT systems with LDAP or XML directory support.

The **Directory (comp. mode)** menu allows configuration of LDAP or XML corporate directory services.

The screenshot displays the 'Directory (comp. mode)' configuration page. On the left is a navigation menu with options like Configuration, Status, System, Sites, DECT base stations, WLAN, DECT phones, Conference rooms, System features, General settings, Feature access codes, Alarm triggers, Digit treatment, Directory, Directory (comp. mode) (highlighted), XML applications, CoA profiles, and Licenses. The main area shows a table of directory entries:

	Order	Type	Active	Name	Server	Tasks
<input type="checkbox"/>	2	LDAP	<input type="checkbox"/>	LDAP-Comp	10.103.35.134	Create
<input checked="" type="checkbox"/>	1	XML	<input checked="" type="checkbox"/>	XML-comp	10.135.35.134	Configure Delete

Below the table is the 'Directory entry' configuration panel. It has three tabs: 'General' (selected), 'LDAP', and 'XML application'. The 'General' tab contains the following fields:

- Type: XML (selected)
- Active:
- Order: 1 (selected)
- Name: XML-comp

At the bottom of the panel are 'OK' and 'Cancel' buttons.

#### 6.12.6.1 Creating New Directory Entries

Adding directory entries is only possible in **configuration mode**. You can configure up to five directory entries. To add a new entry, do the following:

4 In the **Tasks** panel, click **Create**.

The **New directory entry** panel opens and provides various tabs where the directory data must be entered.

5 Configure the directory entry (see parameter descriptions below).

6 Click **OK** to save your changes.

You can specify values for the following parameters in the **New directory entry** panel:

### General tab

The following table describes the parameters on the **General** tab.

Parameter	Description
<b>Type</b>	Interface type supported by the directory server. Possible values: LDAP or XML.
<b>Active</b>	Enables or disables the directory entry on the DECT phone.
<b>Order</b>	Specifies where you want the directory to appear in the list.
<b>Name</b>	Name to be displayed for the directory (Latin-1 character set is supported). <b>Note:</b> If there is only one directory entry configured, this value is ignored when the user searches for a number in the telephone's central directory. SIP-DECT 6.0 and later supports the "SIPProxy" placeholder for a directory entry name, in place of the current primary, secondary or tertiary SIP server address.

### LDAP tab

The following table describes the parameters on the **LDAP** tab (only available when LDAP is selected as the directory type).

Parameter	Description
<b>Search base</b>	Location in the LDAP directory from which the search begins (e.g., "ou=people, o=my com"). The configuration is valid for all DECT phones that support the LDAP directory feature. To make search requests unique for different users, the search base configuration can include placeholders that are replaced by user-specific values when submitting the LDAP request to a server. The following placeholders are defined: <ul style="list-style-type: none"> <li>• "&lt;TEL&gt;" (for the user's telephone number)</li> <li>• "&lt;DESC1&gt;" (for the user's "Description 1" attribute)</li> <li>• "&lt;DESC2&gt;" (for the user's "Description 2" attribute)</li> <li>• "SIPProxy" (for the current primary, secondary or tertiary SIP server address); supported for release 6.1 and later</li> </ul>
<b>Search type</b>	Attribute on which searches are performed ( <b>Surname</b> or <b>Given name</b> ).
<b>Display type</b>	Display mode for search results ( <b>Surname, First Name</b> or <b>Given name Surname</b> ).
<b>Server</b>	IP address or FQDN of the directory server.
<b>Port</b>	Server port number. The default is 389. SSL (default port 689) is not supported. Windows Active Directory Server uses port 3268.
<b>User name</b>	Name of the account for directory server access, if required.
<b>Password</b>	Password for directory server access, if required. Confirm in the next field. <b>Note:</b> If no user/password is specified, an anonymous bind takes place. SIP-DECT supports LDAP simple bind.
<b>Server search timeout</b>	Interval (in seconds) during which the OMM waits for search results from the LDAP server (1 – 99 seconds).

### XML application tab

The following table describes the parameters on the **XML application** tab (only available when XML is selected as the directory type).

Parameter	Description
<b>Protocol</b>	Transfer protocol used to communicate with the XML directory server ( <b>HTTP</b> or <b>HTTPS</b> ).
<b>Port</b>	Server port number. Default is 80 for HTTP, and 443 for HTTPS.
<b>Server</b>	IP address or FQDN of the directory server.
<b>User name</b>	Name of the account for directory server access, if required.
<b>Password</b>	Password for directory server access, if required. Confirm the password in the next field.
<b>Path (and parameters)</b>	URL (with parameters, if required) to the XML directory on the XML directory server.

#### 6.12.6.2 Changing a Directory Entry

Changing directory entry is only possible in configuration mode. To change the configuration of an existing directory entry, do the following:

- 1 Select the appropriate directory entry in the table.
- 2 Click **Configure** in the **Tasks** panel.
- 3 Change the directory entry parameters as required (see parameter descriptions above).
- 4 Click **OK** to save your changes.

#### 6.12.6.3 Viewing Directory Entry Details

You can view the configuration of a directory in **Monitor Mode**. Do the following:

- 1 Select the appropriate directory entry in the table.
- 2 In the **Tasks** bar click **Show details**.  
The directory entry data is displayed in the detail panel.
- 3 Click **Cancel** to close the directory entry detail panel.

#### 6.12.6.4 Deleting Directory Entries

Deleting directory entries is only possible in **Configuration Mode**. To delete one or more existing entries, do the following:

- 1 Select the appropriate entry/entries in the directory entry table by activating the corresponding checkbox(es).
- 2 In the **Tasks** bar click **Delete**.  
A confirmation dialog opens.
- 3 Click **OK** to confirm.

### 6.12.7 “XML APPLICATIONS” MENU

The SIP-DECT XML terminal interface allows external applications to provide content for the user on the Mitel 600 DECT phone display. To make the XML terminal interface applications available to the DECT phone user, the relevant hooks must be configured in the **XML applications** menu.

There are 15 predefined hooks and 10 hooks which can be freely defined. For a full list of the predefined hooks and their descriptions, see section 5.9.5.

These hooks can be activated or deactivated but not deleted. Up to 10 additional hooks can be created dynamically.

**Please note:** “Caller list” and “Redial list” replace the local caller and redial lists of the Mitel 600 if activated. Additionally the list access must be set to “Automatic” or “PBX” on the DECT phone in the “Settings > List access” menu. If the list access is set to “Local”, the local list is used by the DECT phone.

**Note:** An XML directory entry is also read-only listed in the XML applications menu. For information on configuring XML directories please see section 6.12.5.1.

An activated hook becomes available on a DECT phone (including the corresponding menu entry) after the next DECT location registration of the DECT phone. This can be forced by switching the DECT phone off and on. The same applies if a hook is deactivated.

#### XML terminal interface application – selecting a menu entry on the DECT phone

When a “TextMenu” XML object is displayed on the DECT phone, the user can move with the “Up” and “Down” arrow keys to an entry and select the highlighted entry by pressing the “OK” key.

Alternatively the user can press the digit keys to select a displayed entry. The digit key refers to the displayed line number which shall be selected e.g. 1 selects the first menu line, 2 the second menu line and so forth.

ID	Name	Server	Active
0	Caller list		✘
1	Redial list		✘
2	Presence		✘
3	Server menu		✘
4	Action URI		✘

**XML application #5**

General

Active:

Name:

Protocol: HTTP

Port:  Use default port

Server:

User name:

Password:

Password confirmation:

Path (and parameters):

The tasks which can be performed in the **XML applications** menu are mode-dependant.

Configuration mode	Monitor mode	See section
<b>Create:</b> create new XML hooks		0
<b>Configure:</b> configure selected XML hook in detail panel		6.12.7.2
	<b>Show details:</b> shows selected XML hook in detail panel	6.12.7.3
<b>Delete:</b> delete selected XML hook		6.12.7.4

### 6.12.7.1 Creating a New XML Hook

In addition to the six predefined XML hooks, you can create up to 10 additional XML hooks.

Adding individual XML hooks is only possible in **Configuration Mode**. To add an XML hook proceed as follows:

- 1 In the **Tasks** bar click on the **Create** command.  
The **New XML application** panel opens.
- 2 Configure the XML hook, see parameter description below.
- 3 Press the **OK** button.

The following parameters can be set in the tabs of the **New XML application** panel:

- **Active:** This setting activates or deactivates a configured XML application entry.
- **Name:** The predefined hooks have fixed predefined names. A name must be configured for the free defined hooks.

The following parameters specify the URI:

- **Protocol:** Select the protocol HTTP or HTTPS.
- **Server:** Enter the IP address or the name of the server which provides the XML content.

**Note:** SIP-DECT 6.0 and later supports “SIPProxy” placeholders for XML Server application URLs within SIP redundancy setups. In cases where applications are located on a SIP server, it is necessary to address XML applications by using the current

primary, secondary or tertiary SIP server address. In those cases, the “SIPProxy” placeholder can be used as server input.

- **User name:** Enter the login user name if an authentication is required by the server.
- **Password, Password confirmation:** Enter the password if the authentication is required by the server.
- **Path (and parameter):** Enter the path and query of the URI. For “Feature access codes translation”, the **Path** settings contains placeholders for the queried translation: {subsc} = Number, {ppn} = Device ID, {fac} = FAC

#### 6.12.7.2 Changing an XML Hook

Changing XML hooks is only possible in **configuration mode**. To change the configuration of an existing XML hook, do the following:

- 1 Select the appropriate XML hook in the account table.
- 2 In the **Tasks** bar, click **Configure**.
- 3 Change the XML hook parameters (see parameter descriptions in section 0).
- 4 Click **OK**.

**Note:** The predefined XML hooks cannot be renamed.

#### 6.12.7.3 Viewing XML Hook Details

You can view the configuration of an XML hook in **Monitor Mode**. Do the following:

- 1 Select the appropriate XML hook in the table.
- 2 In the **Tasks** bar click on the **Show details** command.  
The user account data is displayed in the user account detail panel.
- 3 Click **Cancel** to close the XML hook detail panel.

#### 6.12.7.4 Deleting XML Hooks

Deleting XML hooks is only possible in **Configuration Mode**. To delete one or more existing XML hook, do the following:

- 1 Select the appropriate XML hook(s) in the table by activating the corresponding checkbox(es).
- 2 In the **Tasks** bar, click **Delete**.  
A confirmation dialog opens.
- 3 Click **OK** to confirm.

**Please note:** The predefined XML hooks cannot be removed.

### 6.12.8 “COA PROFILES” MENU

SIP-DECT 6.0 and later supports central configuration over the air (CoA) for Mitel 602 DECT phones. The CoA profiles page lists the available CoA profiles that can be downloaded to the DECT phones.

**Note:** The profiles generated by the user\_common.cfg configuration file are also listed in this window. When managed with OMP, they



can be overwritten when the user\_common.cfg configuration file is reloaded. The maximum download size is 4kB.

You can import CoA profiles via the **CoA Profiles** menu. Once you have imported the profiles, you can assign them to specific DECT phone users.

ID	Name	Status	Tasks
			<ul style="list-style-type: none"> <li>Create</li> <li>Configure</li> <li>Delete</li> </ul>

**New CoA profile**

General

Name:

Default:

ID:  ▼

To create a new CoA profile:

- 1 Click **Create** under the Tasks list on the right-hand side of the **CoA profiles** window. The **New CoA profile** dialog opens.
- 2 Configure the settings for the CoA profile:
  - **Name**: Specify a name for the CoA profile
  - **Default**: Indicate whether this is the default CoA profile to be used
  - **ID**: Select an ID for the CoA profile from the drop-down menu.
- 3 Click **Import file** to select the CoA file to import.

The **CoA profiles** page displays the new CoA profile in the table.

## 6.13 “LICENSE” MENU

The **License** panel provides an overview of licenses currently in use. In **Configuration Mode**, you can also import a license file.

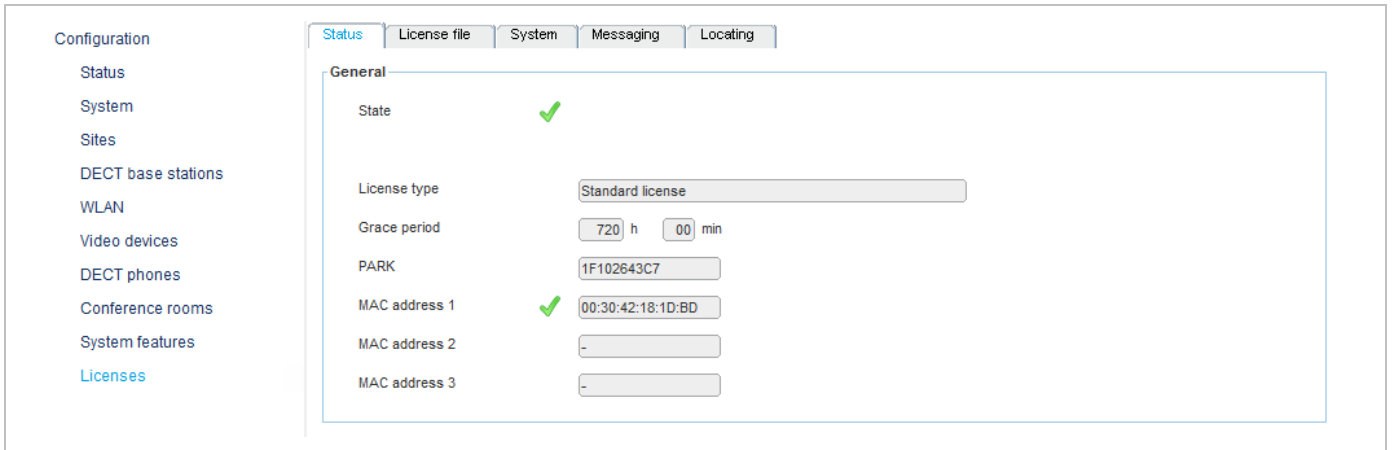

The license information is displayed in the following tabs:

- **Status:** shows general license information.
- **License file:** allows import of a license file
- **System:** shows system license status.
- **Messaging:** shows Integrated Messaging and Alerting Service (IMA) license status.
- **Locating:** shows Locating license status.

**“General” tab**

The General tab displays general information about the current system license.

**“License file” tab**

The License file tab allows you to import a license file (only possible in **Configuration Mode**).

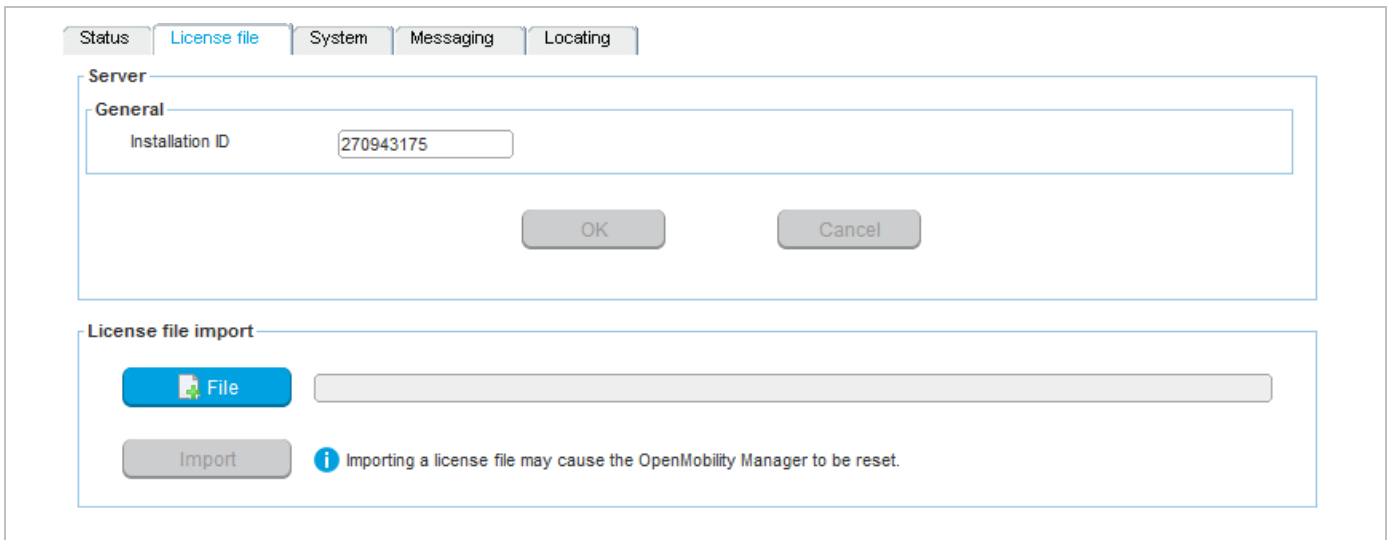

- 1 Click the **File** button to select the path and file name where the license file is stored.
- 2 Click the **Import** button.

**“System” tab**

The “System” tab provides OM System license information. This includes supported software version and number of licensed DECT base stations (RFPs) compared to number of connected DECT base stations.

Status	License file	System	Messaging	Locating
OM System License XXX			✓	
Maximum number of RFPs			256	
Current number of RFPs			12	
License key			U3TUK-74SBC-W5FGR-2E243-38SDM	

### “Messaging” tab

The “Messaging” tab provides OM Messaging and Alerting license information.

Status	License file	System	Messaging	Locating
OM Messaging & Alerting System License			✓	
				Receiving text messages (Emergency, Locating alert) and enhanced messaging features
License key			TNC3K-DX1ZK-T4MJM-XEFW9-WDM83	

### “Locating” tab

The “Locating” tab provides OM Locating license information.

Status	License file	System	Messaging	Locating
OM Locating Server License			✓	
				OM Locating application
OM Locating License XXX			✓	
Maximum number of users allowed to be located			10000	
Current number of users allowed to be located			0	
License key			PZMVX-HTTPK-RH9GR-CM2L8-UUG7B	

## 6.14 “GENERAL” MENU

The **General** menu is available in all program situations. It contains following submenus:

- **Exit**: Selecting this menu entry opens the exit dialog to close the OMP.
- **Options**: Selecting this menu entry opens the **Options** dialog (see below).

### “Options” - “General” tab

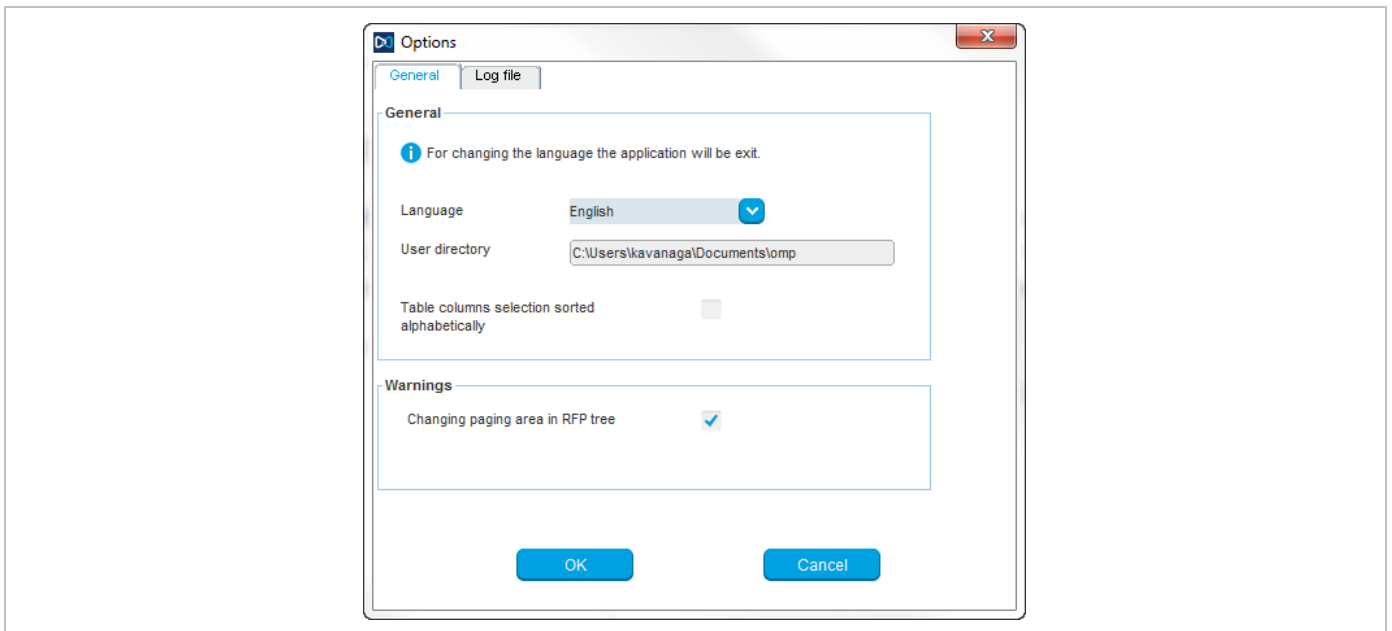

**Language**: You can select the OMP language. After changing the language, the OMP is automatically closed and must be started again.

The field **User directory** shows the path where the following files are saved if necessary:

- System dump file “sys\_dump.txt”
- Expert console log file “spy.log” when the application terminates
- Exception log file “spy\_trace\_<date>\_pxxx” in case of a Java exception, file name extension “xxx” ranges from 000 to 999

In the **Warnings** section you can activate/deactivate the display of warning messages in the OMP.

### Notes on log files

The mechanism for creating the log files is the same as the PC OMM spy log mechanism, what means:

- The maximum size of the log file is 1 GB
- 1000 log files per day at maximum
- Only the 30 newest created log files are kept, older ones are removed automatically
- Log files older than 6 days are removed

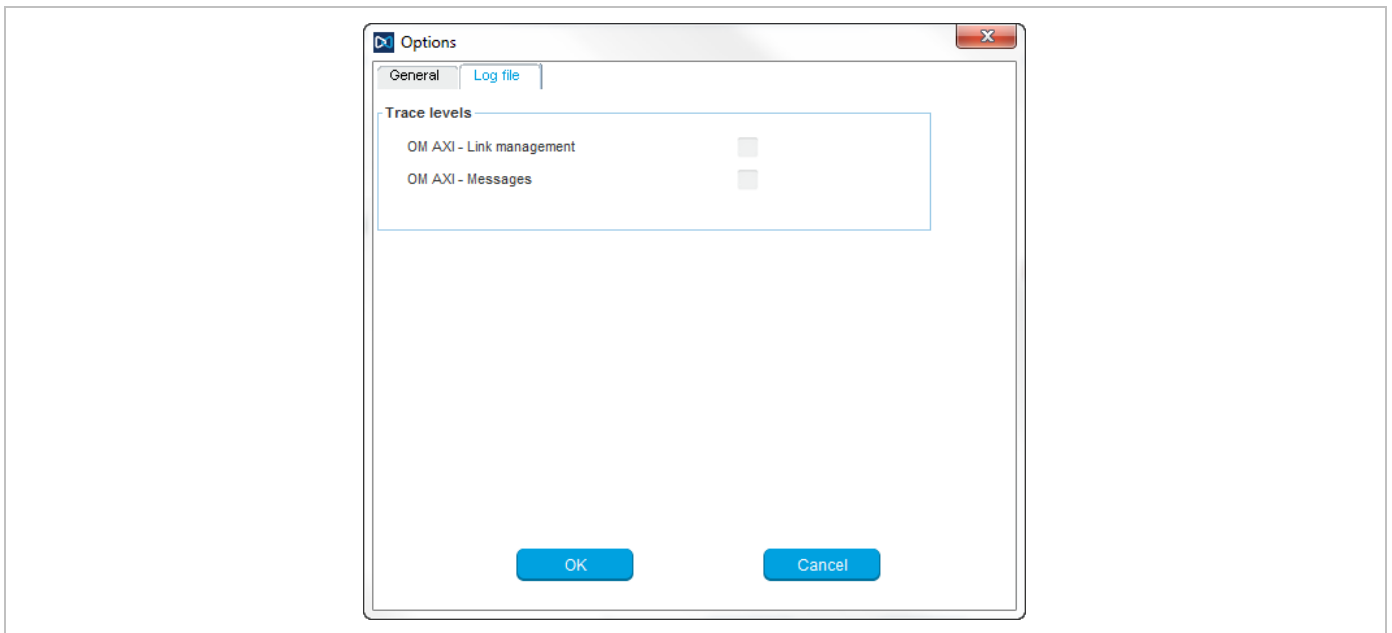

## “Options” - “Log file” tab



In the **Log file** tab you can enable several trace levels.

## 6.15 “HELP” MENU

The **Help** menu is available in all program situations. It contains following submenus:

- **Info:** Selecting this menu entry displays the End User License Agreement (EULA).
- **About AXI:** Selecting this menu entry displays the About AXI dialog. This dialog compares the protocol version numbers which are provided by the OMM with the protocol version numbers supported by the OMP. The warning icons  or  show a version mismatch. A version number “-” means the protocol element is not used by OMP.

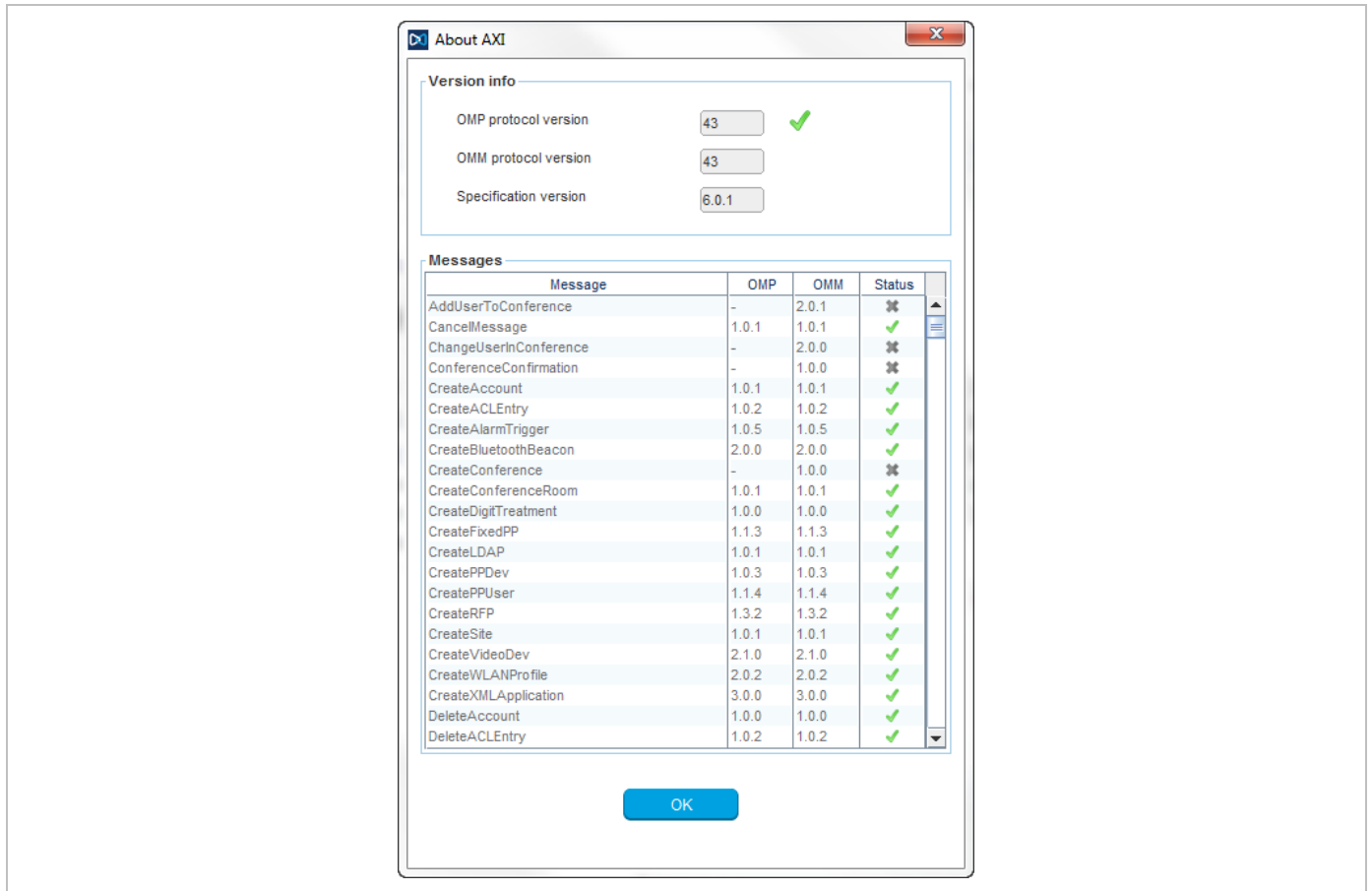

- **About OMP:** Selecting this menu entry displays the OMP version info and copyright.

# 7 CONFIGURATION AND ADMINISTRATION

This section provides detailed information on various configuration and administration aspects of the SIP-DECT solution.

## 7.1 IP SIGNALING AND MEDIA STREAM

To establish a call between an IP Phone and a DECT phone (e.g. Mitel 600 ), the following IP streams must be established:

- A signaling channel to and from the SIP phone.
- A signaling channel to and from the OMM.
- A control interface between the OMM and the RFP that has a connection to the DECT phone (known as the primary RFP).
- A Real Time Protocol (RTP) / Real Time Control Protocol (RTCP) connection between the SIP phone and the primary RFP.

The following figure illustrates this scenario.

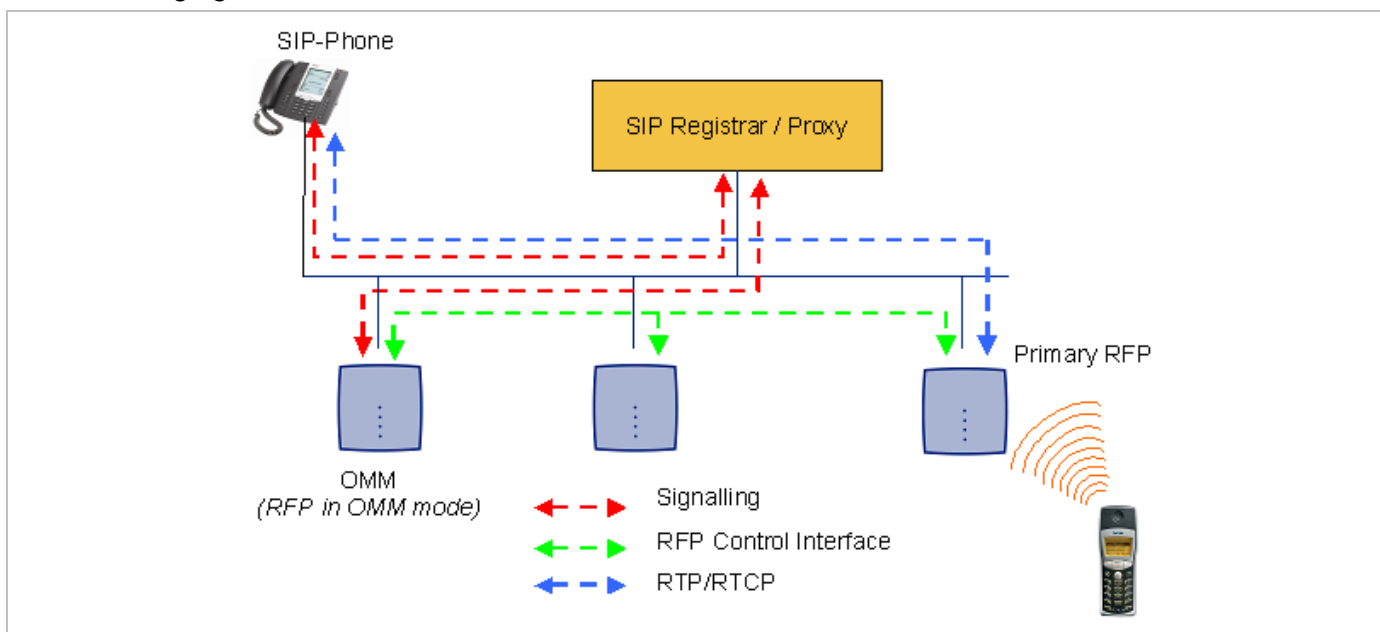

To establish a call between two DECT phones, the same IP streams must be established like in the scenario before, except the IP phone is not involved. The following figure illustrates this scenario.

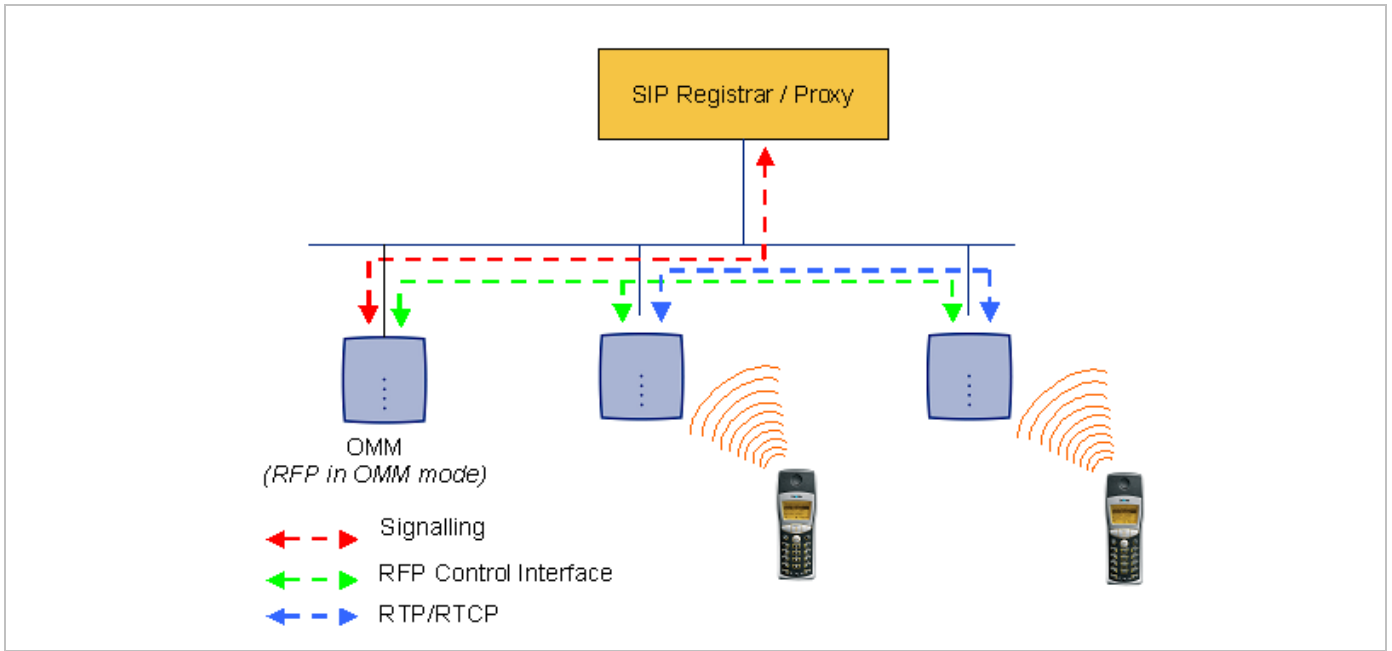

A call from one DECT phone to another that resides on the same RFP will loop back within the RFP if no media gateway is involved. So the call will not pass through to the Local Area Network (LAN). Although the voice packets will not impact LAN traffic, signal packets will.

If the DECT phone user is moving, the DECT phone detects that another RFP has a better signal strength and, therefore, it starts the handover process. The media stream from the IP phone cannot move to the secondary RFP, so the primary RFP uses the LAN to direct the voice to the secondary RFP, as shown in the following figure.

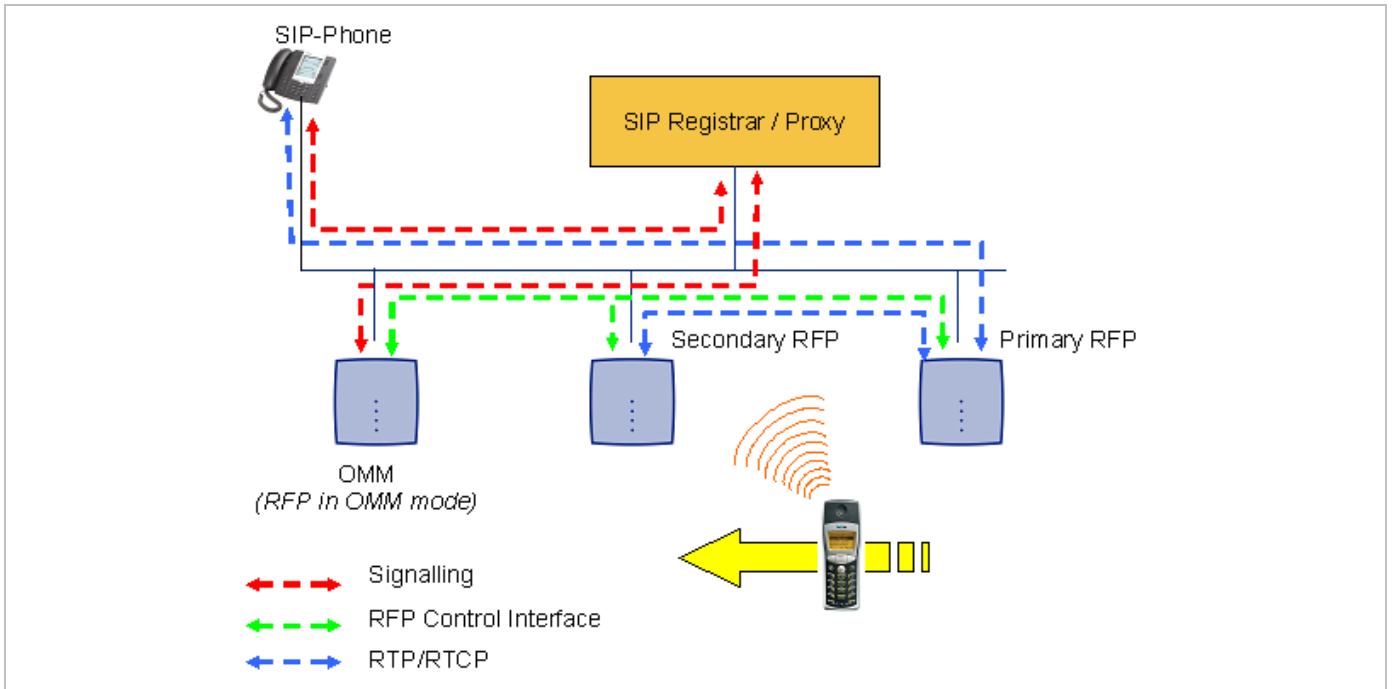

As the DECT phone user moves into the next RFP zone of coverage, the DECT phone detects that the RFP has a better signal strength. Again the media stream from the SIP phone cannot move to the secondary RFP, so the primary RFP uses the LAN to direct the voice to the new secondary RFP.



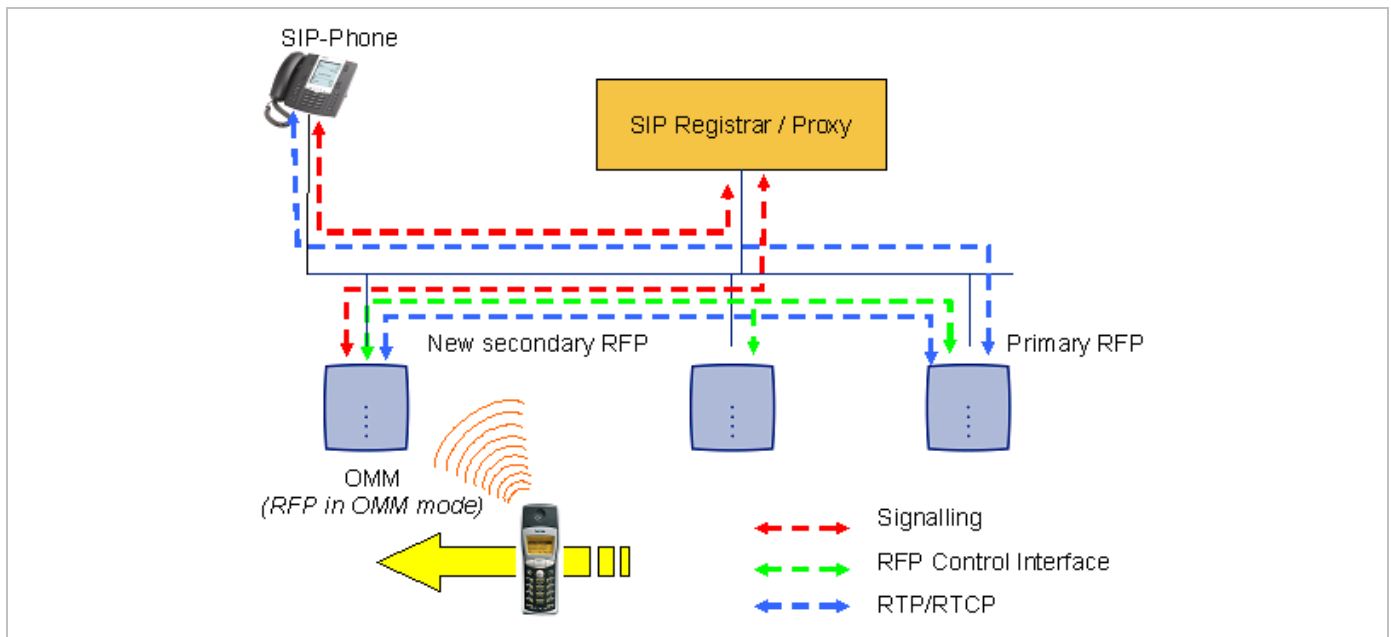

## 7.2 DECT BASE STATION SYNCHRONIZATION

To guarantee a seamless handover if a caller moves from one DECT base station zone of coverage to another DECT base station zone of coverage, an accurate synchronization of the DECT base stations is necessary.

The DECT base stations are synchronized over the air interface. The first DECT base station to complete startup transmits a signal on the air for the other DECT base stations to synchronize from. If a DECT base station gets in sync, it transmits a signal on the air and becomes the sync source for the next DECT base station. Only DECT base stations that can receive a synchronization signal become synchronized.

For the DECT base station to sync to another DECT base station, the signal strength cannot drop below -70 dBm. You must consider this requirement during the site survey.

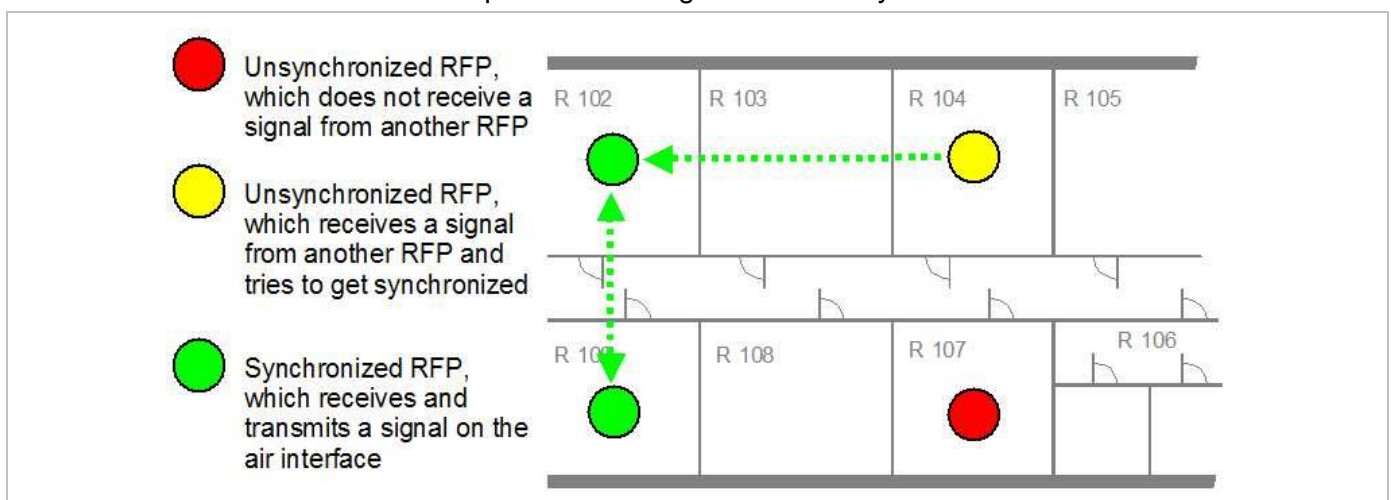

As long as a DECT base station is not in sync, no calls can be established using this DECT base station. If a DECT base station loses the synchronization, the DECT base station does not accept new calls ("busy bit"). There is a delay of maximum 3 minutes until the active calls on this DECT base station are finished. Then it tries to get synchronized again.

A SIP-DECT installation is more reliable if a DECT base station can receive the signal from more than only one DECT base station because the other signals are also used for synchronization.

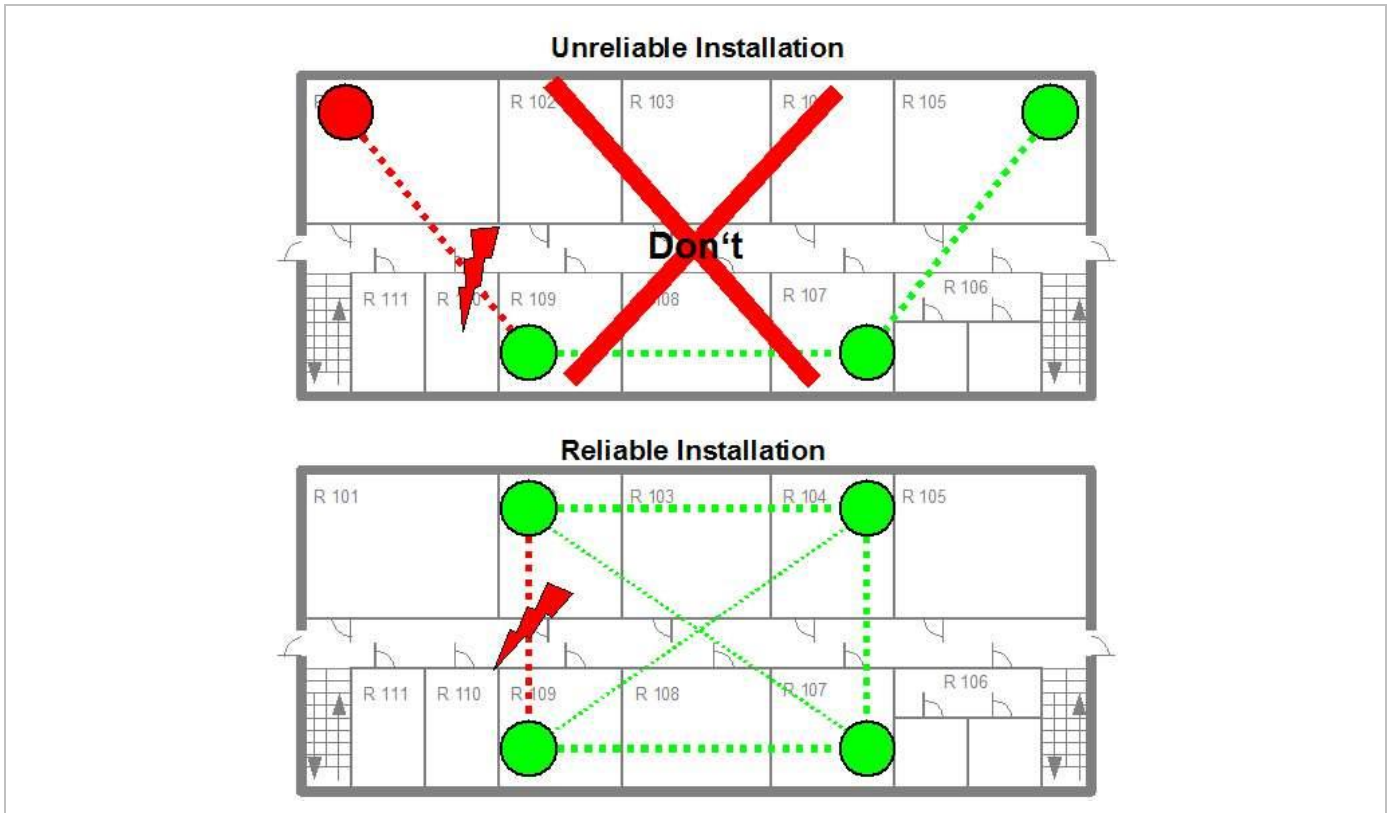

The sync-over-air solution is very reliable because all existing redundant paths are used for synchronization. Thus, hardware tolerances have only very little influence. No DECT base station has a key position. Only unfavorable setups without redundant synchronization paths can cause problems. Sometimes DECT base stations do not need to be synchronized (e.g. if they are in different buildings). These DECT base stations can be put into different clusters. DECT base stations in different clusters are not synchronized with each other. Different clusters start up at the same time independently.

### 7.2.1 INITIAL SYNCHRONIZATION PROCEDURE

To avoid synchronization problems and to speed up the synchronization on system startup, an initial synchronization procedure is used. For every cluster the following synchronization stages are defined.

- Synchronization stage 0
  - If at least one preferred DECT base station was configured, the synchronization process waits up to 30 seconds for an incoming startup message of such a preferred DECT base station. Receiving a message will finish stage 0 and the synchronization process jumps to stage 1.
  - If no message is received within 30 seconds, this stage will be terminated and the next stage begins.
  - If no preferred DECT base station was configured, this stage is ignored.
- Synchronization stage 1
  - If a preferred DECT base station was determined in stage 0, this one becomes the synchronization source for the subsequent DECT base stations. Otherwise the first DECT base station that sends a startup message becomes the synchronization source for the subsequent DECT base stations.

- In this stage, only DECT base stations reporting an RSSI value better than -65 dBm are permitted to perform synchronization.
- If a DECT base station has completed its synchronization, this DECT base station will be also a synchronization source for other upcoming DECT base stations.
- The initial timeout for this stage is 30 seconds. Whenever a DECT base station has finished its synchronization in this stage a new stage timeout value is calculated.
- If no DECT base station comes up within the timeout time or if all the upcoming DECT base stations do not fit the RSSI threshold, this stage will be terminated and the next stage begins.
- Synchronization stage 2
  - The behavior of this stage is identical to stage 1, but an RSSI threshold value of -70 dBm is significant.
- Synchronization stage 3
  - The behavior of this stage is identical to stage 1, but an RSSI threshold value of -75 dBm is significant.
- Synchronization finished
  - No more RSSI threshold value is significant. All DECT base stations that failed the stage conditions above are now permitted to perform synchronization.

The last level “synchronization finished” will be achieved either all registered DECT base stations of this cluster are synchronized or the timer of stage 3 expires.

## 7.2.2 CHECKING THE SYNCHRONIZATION OF A NETWORK

For every cluster a periodically check of the synchronization of the network is done. If the network is split into at least two subnets, all the RFPs of the lesser subnet(s) will be resynchronized. While doing initial synchronization procedure this check is deactivated. You can check the DECT base station synchronization from the **Sync view** menu of the OM Management Portal (OMP), see section 6.7.6.

## 7.3 DECT BASE STATION CHANNEL CAPACITY

The DECT base station has 12 available time slots on air; eight can have associated DSP/media resources for media streams. All DECT time slots are used for control signaling, software download over air, messaging and bearer handover independent of associated DSP/media resources.

If all eight media stream channels are used, the DECT base station announces a “busy bit”. In that case, the DECT phones determine whether another DECT base station has an appropriate signal strength. If so, the DECT phone performs a handover to that DECT base station. Once the handover is complete, the DECT base station lowers its “busy bit”.

Whenever the busy state is announced a log entry is made to the system logs. If the announcement of busy raises in a specific area, an additional DECT base station should be installed to double the number of media streams available for calls.

### Notes on Hi-Q connections

Each Hi-Q connection uses twice the capacity of conventional narrowband on the DECT air interface. Due to this fact, four Hi-Q connections (instead of eight) can be established via one DECT base station. It is not possible to have DECT XQ audio combined with Hi-Q audio within the same connection.

## 7.4 NETWORK INFRASTRUCTURE PREREQUISITES

To establish and maintain an SIP-DECT installation, a network infrastructure is assumed, which comprises at least the following components:

- DECT base stations
- DECT phones
- IP PBX/media server (e.g. Asterisk)
- TFTP server

Depending on the operational modes the following services should be provided:

- DHCP
- TFTP
- SNTP
- DNS
- LDAP
- Syslog daemon

### Notes on network infrastructure prerequisites

- In NA outdoor RFPs may only be installed with the antennas shipped with the units. No other antennas or cabling are permitted. In EMEA the outdoor RFPs are shipped without antennas and you may use the units with one of the optional antennas (separate order no.).
- A TFTP server is no longer required for boot of an RFP 35/36/37 IP or RFP 43 WLAN.
- TFTP, FTP(S), HTTP(S), SFTP are supported for RFP 35/36/37 IP or RFP 43 WLAN software update.

## 7.5 SIP-DECT STARTUP

This section contains detailed information on the startup (booting) process of the SIP-DECT solution. For booting an RFP 32/34 or RFP 42 WLAN, there must be at least one TFTP server on the attached network to load the OMM/RFP application software.

RFP 35/36/37 IP or RFP 43 WLAN uses the internal flash to start the boot image. A fileserver is only needed for software update over the network.

The essential network settings can be alternatively:

- Communicated by a DHCP server at startup time.
- Configured on the RFP with the OM Configurator tool (see section 7.6). The settings made by the OM Configurator will be saved permanently in the internal flash memory of each OMM/RFP.

### 7.5.1 TFTP AND DHCP SERVER REQUIREMENTS

#### TFTP server requirements

The DECT base station obtains the boot image file from a TFTP server. The requirement list for the used TFTP server is defined as follows:

- The support of RFC 1350 /1/ is mandatory.
- To accelerate the download of a boot image file for older 2<sup>nd</sup> generation DECT base stations, it is possible to increase the packet size of the transmitted TFTP packets from 512 bytes per packet to 1468 bytes per packet. To use this optional feature, the TFTP server must support RFC 2347 /3/ and RFC 2348 /4/.
- To reduce the overall download time of the older 2<sup>nd</sup> generation DECT base stations in a system, it is possible to use TFTP multicast download. To use this optional feature, the TFTP server must support RFC 2090 /2/ and RFC 2349 /5/.

To use the TFTP multicast option, the attached network must support multicast too. Furthermore a support of IGMP, RFC 2236 /6/ is required.

**Note:** If many DECT base stations loading the boot image simultaneously, the network load could increase significant. To balance the network load or for backup reasons, it is possible to configure more than one TFTP server in a network.

### **DHCP server requirements**

A DHCP server needs to support RFC 2131 /9/. The TFTP and DHCP server need not to reside on the same host.

## **7.5.2 BOOTING STEPS**

Booting is performed in two steps:

- 1 Starting the boot process.
- 2 Starting the application.

### **Booter startup**

On startup each DECT base station tries to determine its own IP address and other settings of the IP interface from the configuration settings in the internal flash memory. If no settings are available or these settings are disabled, the DECT base station tries to determine these settings via DHCP. Depending on the DECT base station type, the DECT base station software is to be loaded:

- A 3<sup>rd</sup> generation DECT base station gets the application image from internal flash memory.
- An older 2<sup>nd</sup> generation DECT base station only has a small standalone application built into the flash. This software realizes the so-called net boot process. The RFP gets the application image file from the TFTP server.

### **Application startup**

After starting the application image, the RFP software checks the local network settings in its internal flash memory. If no settings are available or if they are disabled, the RFP software starts a DHCP client to determine the IP address of the OMM and other application startup settings. The RFP software acquires the OMM IP address

- within the local network settings, if active
- via DHCP request
- DECT base station configuration file (see 7.7.7)

If the IP address of the actual RFP device matches one of the acquired OMM IP addresses, the DECT base station software continues in OMM mode. Otherwise, the DECT base station runs as normal DECT base station without OMM mode.

**Note:** Only 3<sup>rd</sup> generation DECT base stations are able to run in OMM mode while older 2<sup>nd</sup> generation DECT base stations cannot function as OMM.

### 7.5.3 BOOTER STARTUP

The SIP-DECT DECT base station software includes a booter with the following features:

- VLAN can be configured via the OM Configurator without a static IP configuration. This means that the first DHCP request will be done by using VLAN.
- To balance the network load with older 2<sup>nd</sup> generation RFP devices, up to three TFTP servers can be configured. This can be done using the OM Configurator (local setting) or using the DHCP option 150. Before starting the download, the TFTP server will be selected randomly by the booter. **But**, if the option “Preferred TFTP server” was set by the OM Configurator, the option “TFTP server address” will specify the TFTP server to use. No randomly selection will be done in this case.
- Older 2<sup>nd</sup> generation RFPs only: to reduce the number of TFTP packets sent by the TFTP server, the packet size can be increased. This will be done by using a TFTP option (see 7.5.1 “TFTP server requirements”).
- Older 2<sup>nd</sup> generation RFPs only: Multicast TFTP download is possible if the TFTP server and the connected network support this.
- To indicate the actual state of the booter, the LEDs of the RFP will be used (see 7.5.5).

#### 7.5.3.1 DHCP Client

Within the initial boot process the DHCP client supports the following parameters:

- |  |                          |
|--|--------------------------|
| • IP address   | mandatory                |
| • Net mask   | mandatory                |
| • Gateway  | mandatory                |
| • Boot file name   | mandatory for older RFPs |
| • TFTP server  | mandatory for older RFPs |
| • Public option 224: “OpenMobility” / “OpenMobilitySIP-DECT” | mandatory                |
| • VLAN-ID  | optional                 |
| • TFTP server list   | optional                 |

##### 7.5.3.1.1 DHCP Request

The DHCP client sends the vendor class identifier (code 60) “OpenMobility3G” (3<sup>rd</sup> generation RFPs) or “OpenMobility” (older 2<sup>nd</sup> generation RFPs) and requests the following options in the parameter request list (code 55):

- Subnet mask option (code 1)
- Router option (code 3)
- VLAN ID option (code 132)
- TFTP server list (code 150)
- Public option 224 (code 224) (*string “OpenMobility” or “OpenMobilitySIP-DECT”*)
- Public option 225 (code 225) (*VLAN ID, not relevant for SIP-DECT*)

- Public option 226 (code 226)      (*not relevant* for SIP-DECT)

#### 7.5.3.1.2 DHCP Offer

The DHCP client selects the DHCP server according to the following rules:

- The **public option 224 (code 224)** has a value equal to the string “OpenMobility”,  
or
- the **public option 224 (code 224)** has a value equal to the string “OpenMobilitySIP-DECT”.

If none of the two rules above match, the DHCP offer is ignored.

Information retrieved from the DHCP offer:

- The IP address to use is taken from the **yiaddr** field in the DHCP message.
- The IP net mask is taken from the **subnet mask option (code 1)**.
- The default gateway is taken from the **router option (code 3)**.
- The TFTP server IP address is taken from the **siaddr** field in the DHCP message and additionally DHCP option 150, if available.
- The boot image filename is taken from the **file** field in the DHCP message, if this field is empty, the default filename is used.

#### 7.5.3.1.3 Retries

If the DHCP client does not get an appropriate DHCP offer, a new DHCP request is sent after 1 second. After 3 DHCP requests are sent the DHCP client will sleep for 60 seconds. During this time the booter accepts a local configuration with the OM Configurator.

This cycle repeats every 3 minutes until either **all** the required DHCP options are provided or the system is manually configured using the OM Configurator tool.

#### 7.5.3.2 TFTP Client

The TFTP client will download the application image from the TFTP server. Both TFTP server and the name of the application image are supplied via the DHCP client. The application image is checksum protected.

Downloading the application image via TFTP is mandatory for older 2<sup>nd</sup> generation RFPs only. 3<sup>rd</sup> generation RFPs will load the application image from the internal flash, and (if configured) also download the application image via TFTP for update.

#### 7.5.3.3 Booter Update

With older second generation RFPs, each application software image comes with the latest released booter software. The application software will update the booter automatically. With third generation RFPs, the booter will only be updated if you update the software.

If you downgrade the RFP's application software image to an older release, the booter does not downgrade automatically. In addition, if you want to use the OM Configurator tool (see 7.7), the OM Configurator version must match the booter software version.

## 7.5.4 APPLICATION STARTUP

After successfully starting the application software, the DECT base station checks the local network settings in its internal flash. If no settings are available or if they are disabled, it starts a DHCP client to determine the IP address of the OMM and other application startup settings.

### 7.5.4.1 DHCP Client

The DHCP client is capable of receiving broadcast and unicast DHCP replies. Therefore the flags field is 0x0000. The DHCP request contains the well-known magic cookie (0x63825363) and the end option (0xFF).

#### Parameters

The following parameters are supported within this step:

Option / Field	Meaning	Mandatory
yiaddr	IP address of the IP-RFP	yes
siaddr	Parameter named "Boot Server Host Name" with value as the IP address of the TFTP server	no (3G RFPs) yes (older 2G RFPs)
File	Parameter named "Bootfile Name" with value of the path (optional) and name of the application image. For example "iprfp3G.dnld" (3 <sup>rd</sup> generation RFPs) or "iprfp2G.tftp" (older 2 <sup>nd</sup> generation RFPs).	no (3G RFPs) yes (older 2G RFPs)
option 1	Subnet mask	no
option 3	Default Gateway	no
option 6	Domain Name Server	no
option 15	Domain Name	no
option 42	IP address of a NTP server	no
option 43	Vendor-specific options (see table below)	yes
option 66	Provisioning URL for the OMM (ConfigURL). URL of an external server that provides configuration files for the Base Station(s) hosting the OMM.  <b>Note:</b> In SIP-DECT 2.1 - 6.1, this option was used for the RFP Config file server. If you want to specify a URL for the RFP Config file server, use option 233 instead.	no
option 132	VlanId	no
option 150	TftpServerIpList	no
option 224	Parameter named magic_str must be set to value "OpenMobility" or "OpenMobilitySIP-DECT".	yes
option 233	URL that specifies the protocol, server and path to access the DECT base station configuration files (see section 7.9). For SIP-DECT 6.1 or earlier, this option takes priority over option 66 when set.	no



### Vendor specific options

The Vendor Specific Options consist of:

Vendor Specific Option	Meaning	Length	Mandatory
option 10	ommip1: Used to select the IP-RFP that hosts the Open Mobility Manager (OMM).	4	yes
option 14	syslogip: IP address of a Syslog Daemon	4	no
option 15	syslogport: Port of a Syslog Daemon	2	no
option 17 (SIP-DECT 5.0 and older)	Country: Used to select the country in which the OMM resides. This enables country specific tones (busy tone, dial tone, ...).	2	no
option 18 (SIP-DECT 5.0 and older)	ntpservername: Name of a NTP Server	x	no
option 19	ommip2: Used to select a secondary IP-RFP that hosts the standby Open Mobility Manager (OMM). This option must be included if the OMM Standby feature is used (see section 7.15).	4	no
option 43 sub-option 1 (SIP-DECT 6.2 and later)	URL that specifies the protocol, server and path to access the DECT base station configuration files (see section 7.9).		no
option 43 sub-option 2	Provisioning URL for the OMM (ConfigURL). URL of an external server that provides configuration files for the Base Station(s) hosting the OMM.		no

### Example

An example of the minimal contents for the Option 43 parameter value would be:

**0a 04 C0 A8 00 01** where “C0 A8 00 01” represents “192.168.0.1” for the OMM IP.

The option 43 contains a string of codes in hex the format is “option number” “length” “value” in this example

0a = option 10 (ommip1)

04 = following value is 4 blocks long

C0 A8 00 01 = 192.168.0.1

If there is more than one option, add the next option at the end of the previous one. Depending of the DHCP server you must end the option 43 with FF.

### Country specific tones (SIP-DECT 5.0 and older ONLY)

Tones for the following countries are supported:

Country code	Country	Country code	Country
1	Germany	15	Hungary
2	Great Britain	16	Poland
3	Switzerland	17	Belarus
4	Spain	18	Estonia

6	Italy	19	Latvia
7	Russia	20	Lithuania
8	Belgium	21	Ukraine
9	Netherlands	22	Norway
10	Czechoslovakia	24	Sweden
11	Austria	25	Taiwan
12	Denmark	100	North America
13	Slovakia	101	France
14	Finland	102	Australia

#### 7.5.4.2 Configuration using DHCP

The DHCP client of the RFP family requests several parameters that are used to configure the RFP. The DHCP client vendor class identifier (option 60) is different for the different RFP generations:

- 3rd generation RFPs (RFP 35/36/37 IP / RFP 43 WLAN) use “OpenMobility3G”.
- Older 2<sup>nd</sup> generation RFPs (RFP 32/34 / RFP 42 WLAN use) “OpenMobility”.

BOOTP/DHCP Option	Meaning	Type	Remarks
siaddr	IP address of the TFTP server	4 octets	Optional for 3G RFPs for SW update; Mandatory for older 2G RFPs because of the NETBOOT process;
File	Path to the boot image server by the TFTP server	N octets	Optional for 3G RFPs for SW update; Mandatory for older 2G RFPs because of the NETBOOT process
150	TFTP server list	N * 4 octets	Only used by the NETBOOT process of older 2G RFPs
224	Magic String	“OpenMobility” or “OpenMobilitySIP-DECT”	The client uses this option to select the server, mandatory

\* The magic string “OpenMobilitySIP-DECT” instead of “OpenMobility” (as defined in SIP-DECT 2.x) makes sure that a SIP-DECT software is loaded into the RFP 35/36/37 IP/ RFP 43 WLAN even an different, non-SIP-DECT SW is previously installed and running.

#### 7.5.4.3 Selecting the Right DHCP Server

The DHCP client requests its own IP address using code 50. The DHCP client will select the DHCP server that offers the currently used IP address. Additionally the mandatory options must be offered otherwise the DHCP offer is ignored by the DHCP client.

If no matching reply was received, the DHCP client resends the request 2 times after 1 second. Then the DHCP client will wait for 1 minute before resending 3 requests again.

If the DHCP client cannot accept a DHCP offer within 30 minutes, the RFP is rebooted.

### 7.5.5 RFP LED STATUS

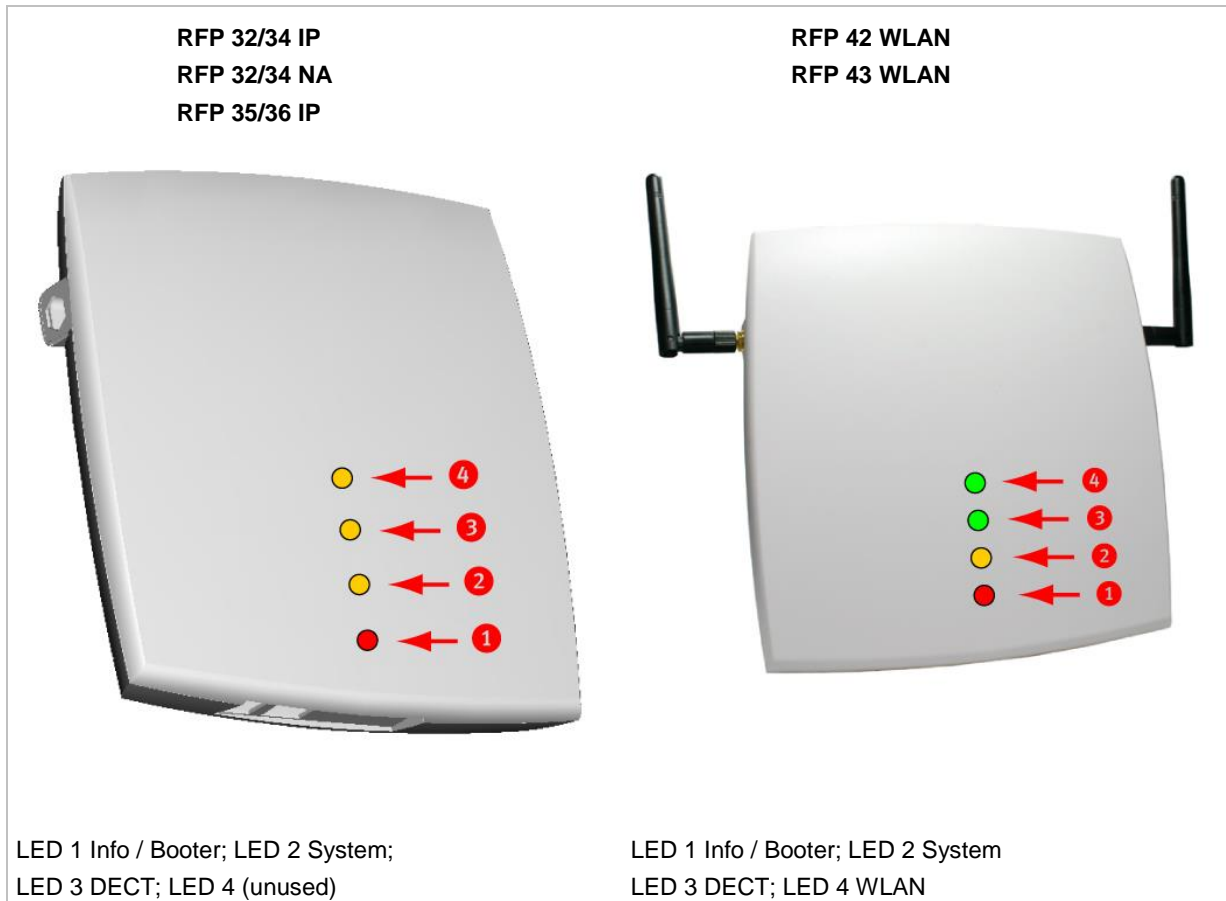

The following tables show the LED status of an RFP according to the different states.

A red respectively orange colored field in the table means that the LED glows permanently in red or orange. A split field with e.g. the specification 1s/1s means that the LED is flashing with a frequency of one second LED red on and one second LED off. Grey means that the LED is off.

#### 7.5.5.1 Booter LED Status

##### RFP 35/36 IP, RFP 43 WLAN

The RFP 35/36 IP and RFP 43 WLAN booter uses LED1 for signaling its activity. After power up, the LED 1 (INFO) is red. The successful start of the boot image is signaled by the LED 1 turning orange.

##### RFP 32/34 IP, RFP 32/34 NA, RFP 42 WLAN

The following table illustrates the different meaning of the LEDs while the booter is active.

	LED1 (INFO)	LED2 (OMM / SYSTEM)	LED3 (DECT)	LED4 (WLAN)	
Booter	cont.				Power connected

	LED1 (INFO)		LED2 (OMM / SYSTEM)		LED3 (DECT)		LED4 (WLAN)		
	cont.		cont.		cont.		cont.		Wait for OMM Configurator Input
	1s	1s							DHCP
	1,9s	0,1s	cont.		cont.		cont.		DHCP failed, wait for OMM Configurator Input
	0,25s	0,25s							TFTP download after DHCP
	0,25s	0,25s	cont.						TFTP download after local configuration
	0,25s	0,25s			cont.				TFTP download after DHCP Multicast
	0,25s	0,25s	cont.		cont.				TFTP download after local configuration and multicast
	3,9s	0,1s	cont.		cont.		cont.		TFTP failed, wait for OMM Configurator Input

Now, the kernel / application is running: LED1 will never be RED

### 7.5.5.2 Application LED Status

The following tables illustrate the different meaning of the LEDs while the application is starting or active.

#### RFP 35/36 IP, RFP 43 WLAN

	LED1 (INFO)		LED2 (OMM / SYSTEM)		LED3 (DECT)		LED4 (WLAN)		
Kernel	cont.								kernel boot phase (inflator, ...)
RFPM	1s	1s							DHCP phase
	1,85s	0,5s							DHCP failure (idle loop)
	0,5s	0,5s							obtaining external configuration
	0,85s	0,15s							external configuration failure
	cont.								Ready
	1,85s	0,15s							Up & running + RFP houses OMM
RFP general			1s	1s					OMM connect phase
			1,85s	0,15s					OMM connection failure (idle loop)
			cont.						Up & running (OMM connected)

	LED1 (INFO)		LED2 (OMM / SYSTEM)		LED3 (DECT)		LED4 (WLAN)		
			1,85s	0,15s					Up & running + OMM warning
			1,85s	0,15s					Up & running + OMM failure
RFP DECT					cont.				DECT not configured on this RFP
					1,85s	0,15s			DECT inactive (not synced yet)
					cont.				DECT 'on air'
					1,85s	0,15s			DECT + call active
					1,85s	0,15s			DECT + call active + busy bit
RFP WLAN							cont.		WLAN not configured on this RFP
							1,85s	0,15s	WLAN inactive yet
							cont.		WLAN 'on air'
							1,85s	0,15s	WLAN + assoc. clients
							cont.		WLAN failure (e.g. 10 Mbit/s uplink)
Reboot request	cont.		cont.		cont.		cont.		RFP will reboot

## 7.6 STATE GRAPH OF THE START-UP PHASES

The following figure illustrates the start-up phase for older 2<sup>nd</sup> generation RFPs. 3<sup>rd</sup> generation RFPs use a similar start-up sequence, but they start with the application phase (see below).

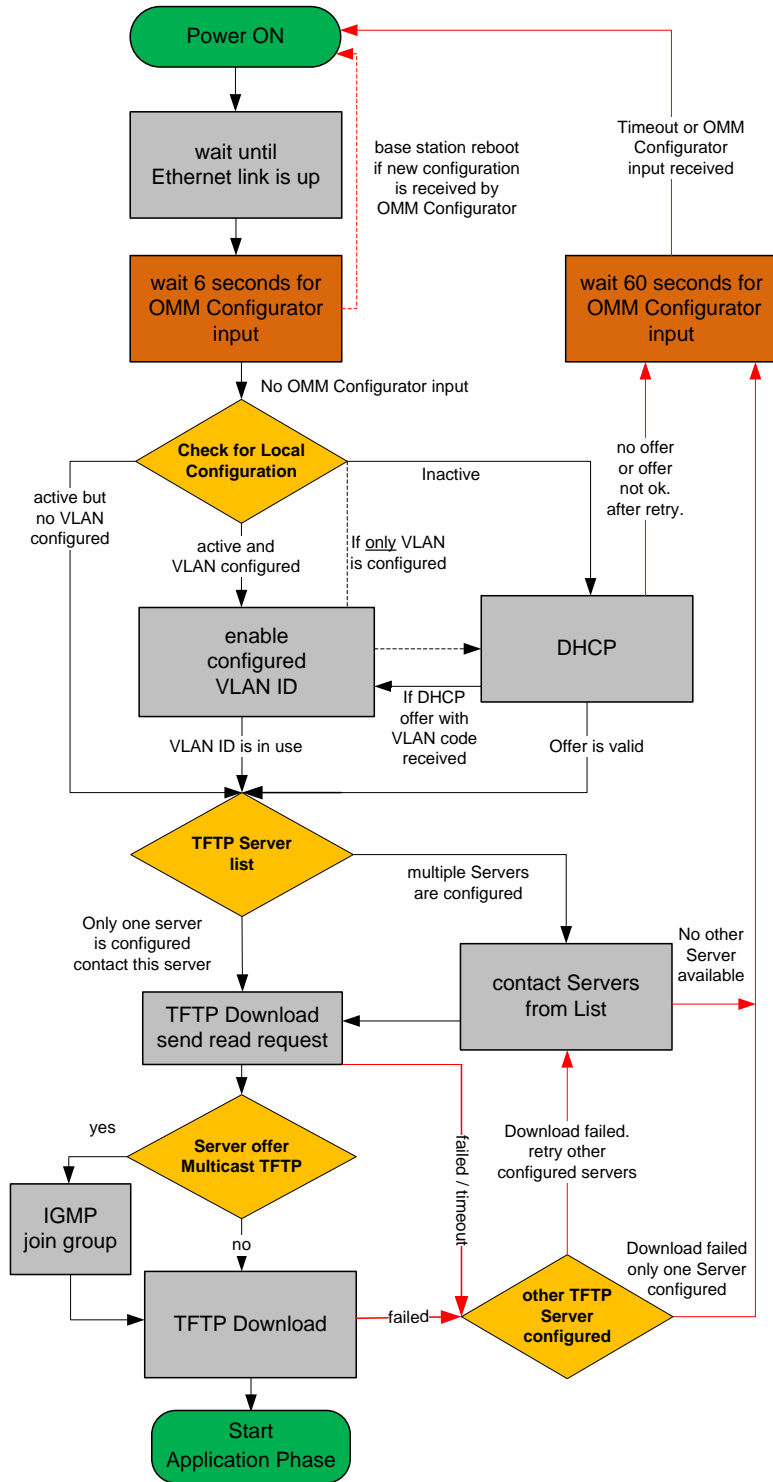

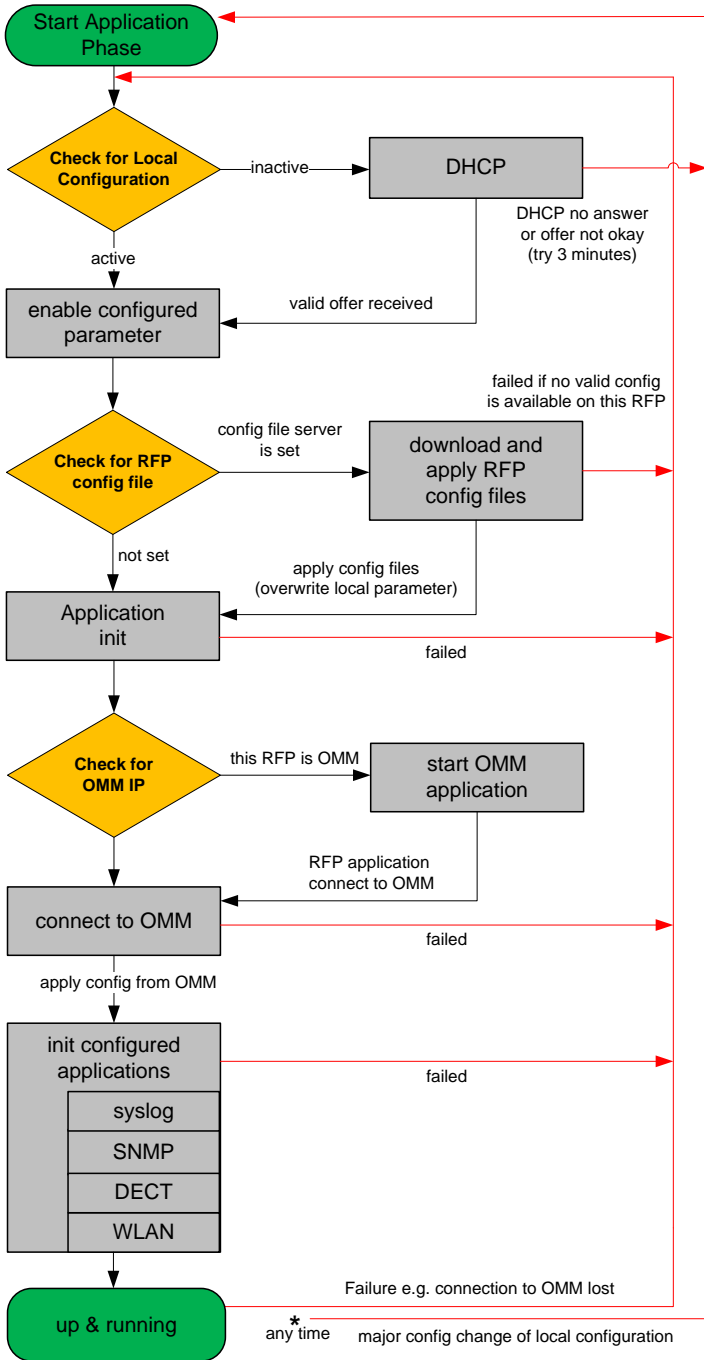

## 7.7 LOCAL DECT BASE STATION CONFIGURATION (OM CONFIGURATOR)

As an alternative to DHCP configuration, you can use the OM Configurator tool to statically configure the DECT base stations individually. RFP settings configured through the OM Configurator tool are saved permanently in the internal flash memory of the RFP. The OM Configurator version must match the installed SIP-DECT software version to be used for the local configuration of RFPs.

**Please note:** The OM Configurator requires the Java Runtime Environment version 1.7 or higher.

**Please note:** An initial configuration of the RFPs 35/36/37 IP / RFP 43 WLAN via the OM Configurator tool requires a login and password. The default login and password is “omm” and “omm”. No login is required for the initial configuration of the previous RFP family (RFPs 32/34 / RFP 42 WLAN. If the RFP is configured by the OMM later on, the OMM also sets the configuration password. You must enter the OMM’s full access user and password in the OM Configurator tool then.

At start-up of the OM Configurator displays a table with configuration data for all RFPs. The task bar on the right side shows permitted actions. The Info console in the lower part of the window shows information and errors as they occur during OM Configurator operation

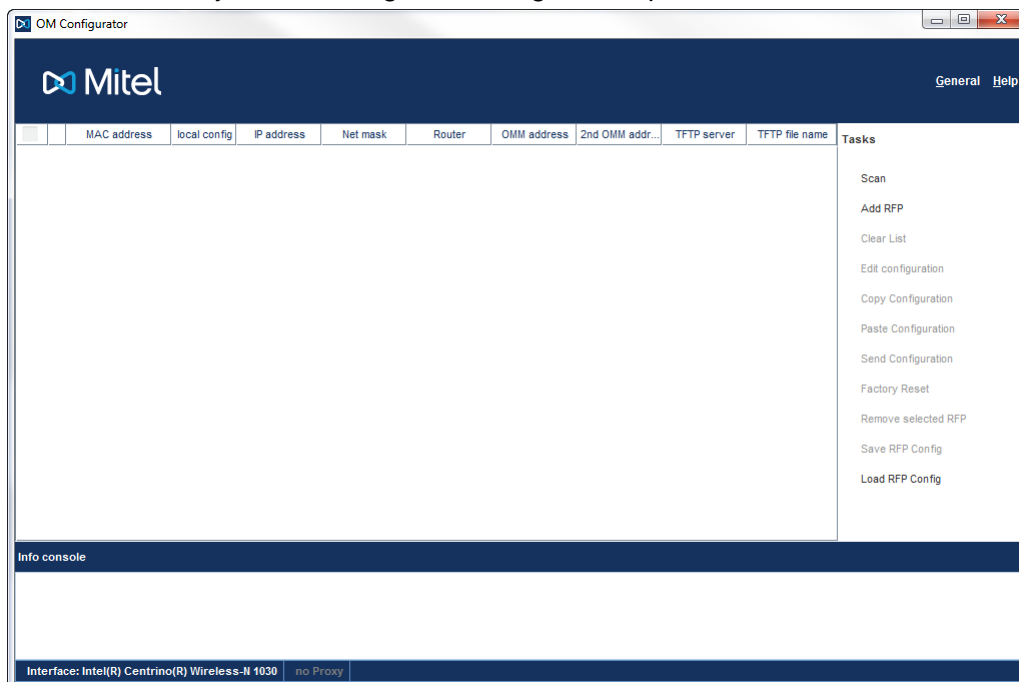

### 7.7.1 SELECTING THE NETWORK INTERFACE

You can select the network interface of the computer used by the OM Configurator via the **General -> Options** menu. The selected interface is shown on the status line of the program.



## 7.7.2 ADDING DECT BASE STATIONS FOR CONFIGURATION

Before you can configure an RFP, you must add the RFP to the OM Configurator database. You can add an RFP record by:

- scanning for RFPs that are already attached to the network
- entering the MAC address of the RFP
- loading a configuration file that contains RFP MAC addresses and configuration parameters

**Please note:** Adding an RFP to the OM Configurator database does not modify the RFP configuration. Configuration data must be transmitted explicitly to the RFP(s) through the **Send Configuration** option.

## 7.7.3 SCANNING FOR DECT BASE STATIONS

The OM Configurator tool can scan for RFPs on the LAN segment.

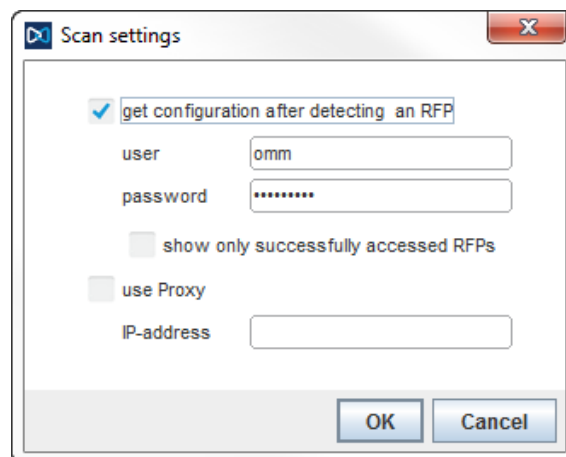

- If **get configuration after detecting an RFP** is enabled, the OM Configurator attempts to fetch the local configuration settings from all RFPs that are detected during the scan. The program uses the **user/password** combination if an access without login data fails.
- If **show only successfully accessed RFPs** is enabled, the OM Configurator adds only RFPs that provide configuration information to its database, and displays those RFPs in the OM Configurator table.
- The **use Proxy** parameter allows access to RFPs that are located in network segments other than the segment that hosts the OM Configurator. The **IP-address** field must contain the address of a RFP located in the network segment to be scanned. This RFP works as proxy and must be up and running. You initiate the scan process by clicking **OK** button. The OM Configurator adds the results to the table. In rare cases, it is possible that a RFP is expected to appear in the table after the scan operation but does not. If this occurs, repeat the scan operation.

## 7.7.4 ADDING DECT BASE STATIONS MANUALLY

You can add an RFP to the OMM Configurator database manually.

When you click the **Add RFP** option in the task bar, the OM Configurator displays the “Add RFP” dialog. You must specify the MAC address of the RFP in the **MAC Address** field.

Optionally, you can also specify an IP address. If an IP address is assigned, the OM Configurator automatically proposes an incremented IP address the next time the “Add RFP” function is invoked.

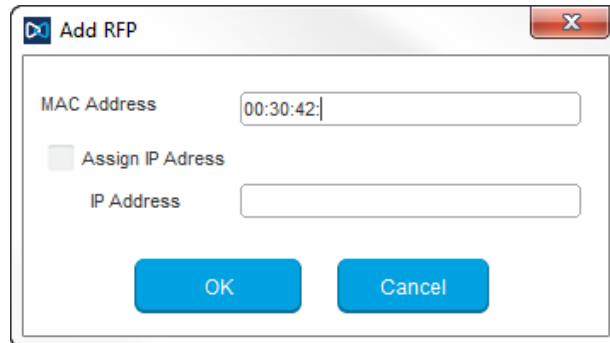

### 7.7.5 LOADING DECT BASE STATION DATA FROM FILE

You can import an RFP configuration file to the OM Configurator.

When you click on the **Load RFP Config** option, the OM Configurator opens a dialog window that prompts you to browse for the configuration file. All found valid RFP entries in the file are added to the OM Configurator database and displayed in the table.

### 7.7.6 EDITING DECT BASE STATION CONFIGURATION DATA

You can edit the configuration of a DECT base station stored in the OM Configurator database. When you double-click on a table row, the OM Configurator displays a Detail Data window below the table, with the “General” panel activated. You can also access this window by selecting one or more entries in the table and clicking the **Edit configuration** option in the task bar.

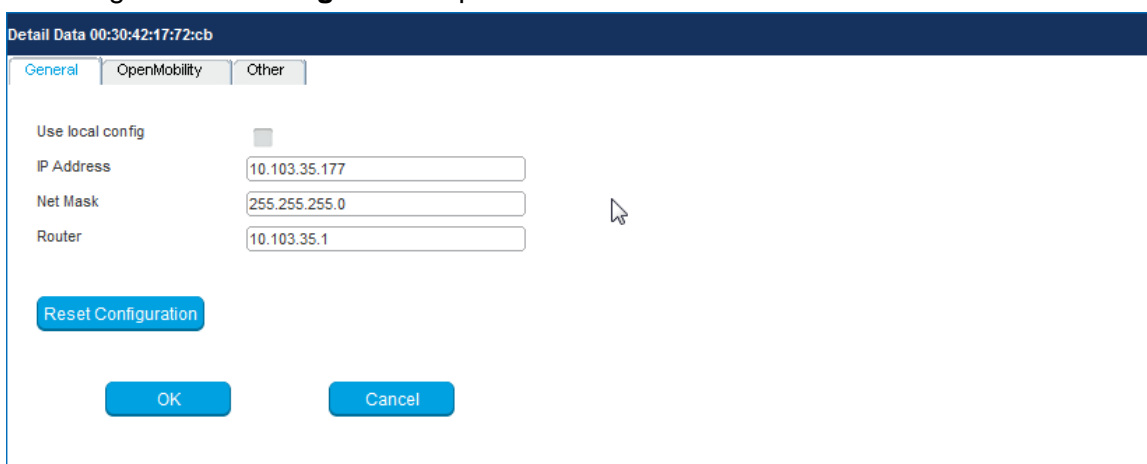

You can change parameters for multiple RFPs by selecting more than one RFP in the table. Parameter settings that differ between the selected RFPs are shown as “\*\*\*” and retain their values if you do not make any modifications.

You cannot change the IP address value when you select more than one RFP.

If more than one parameter value is allowed (e.g. Router, DNS addresses), you must separate the values by a space.

If you click the **Reset Configuration** button, all configuration parameters are removed and local configuration in the OM Configurator is disabled. The **Send Configuration** option is also needed in this case in order to update the configuration of the RFP locally.

When you click the **OK** button, changed parameter values are committed to the database. The system performs validation checks for some parameter values. If this check fails, the system displays an error message in the Info console and the misconfigured parameter value is marked with a red frame (allowing you to correct the value). Modified RFP records are marked (▶) beside the corresponding table row.

If you press **Cancel** or select another RFP in the table, any changes are discarded.

When you press either **OK** or **Cancel**, the Detail Data panel disappears and a number of task bar options (e.g. **Send Configuration**) are re-enabled.

### 7.7.6.1 Other parameter panel

You can set and edit less frequently used parameters on the **Other** panel of the **Detail Data** window.

If the parameter you want to add or edit is listed in the table on the **Other** panel, click on it to display the parameter name and value in the fields on the top-right side of the panel. Click the **Change** button to commit the changed value.

If the parameter value field is empty, the parameter is cleared on the RFP when you click **Send Configuration**.

You can add a new parameter by selecting a parameter name from the drop-down list and clicking the **New** button.

### 7.7.6.2 Copy and Paste

You can assign parameter values from one RFP to one or more other RFPs.

To perform this operation, you must ensure that the **Detail Data** window is not active. If the **Detail Data** window is open, commit your changes or cancel to close the window.

Select an RFP in the table and click the **Copy Configuration** option in the task bar. Next, select one or more RFPs as destination RFP(s) and click the **Paste Configuration** option. The system displays the Paste Data dialog window.

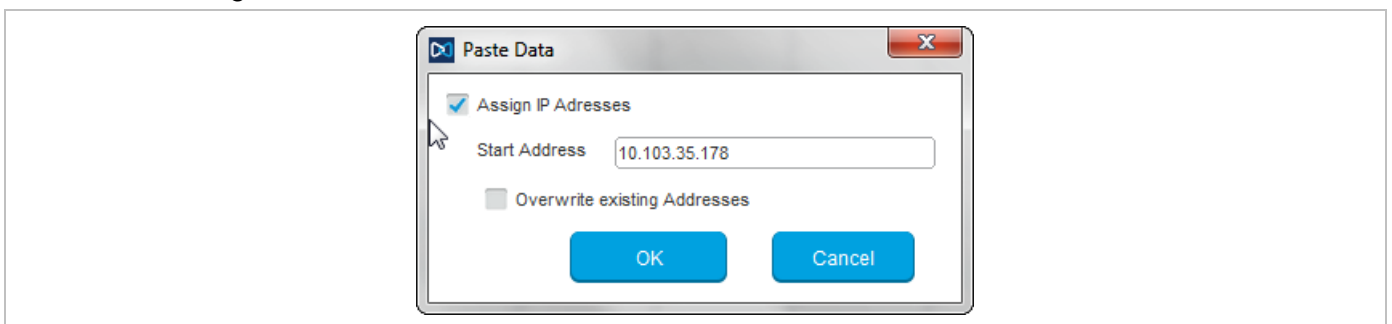

If the **Assign IP Addresses** option is enabled, you must provide a valid IP address in the **Start Address** field. The system may display a suggested address, based on a previous paste or Add RFP operation. The IP address is incremented by one for each RFP.

If the **Overwrite existing addresses** parameter is not enabled, an IP address is only assigned if the IP address field of the target RFP is empty.

### 7.7.6.3 Configuration Parameters

The following table lists the available configuration parameters for the DECT base station.

Parameter	Mandatory/Optional	Description
Use local config	Mandatory	Specifies whether the local configuration settings should be used at boot-up or not
IP Address	Mandatory	IP address of the DECT base station.
Net Mask	Mandatory	Subnet mask of the IP network
TFTP server address	Mandatory	IP address of the TFTP server (set to 0.0.0.0 if not used)
TFTP file name	Mandatory	The boot file to be read from the TFTP server
TFTP server list	Used only by: RFP 32/34 RFP 42 WLAN Optional	List of additional TFTP servers to load the boot file
Preferred TFTP server	Used only by: RFP 32/34 RFP 42 WLAN Optional	TFTP server from which to load the boot file first
OMM address	Mandatory	IP address of the OpenMobility Manager
Router	Optional	IP address of the default gateway
DNS address	Optional	IP address of the DNS server
DNS domain	Optional	Domain name of the network
Broadcast address	Optional	Broadcast address for the network
2nd OMM address	Optional	IP address of the standby OMM
VLAN ID	Optional	VLAN identifier
Use VLAN and DHCP	Optional	Specifies whether only the local VLAN configuration settings should be used when booting or not
Syslog server address	Optional	Destination IP address for the syslog file
Syslog server port	Optional	Destination port address for the syslog file
RFP configuration file server	Optional	URL of a server with RFP configuration files (ipdect.cfg <MAC>.cfg) alternatively or in addition to OM Configurator settings. Syntax: {ftp ftps http https}://[user:password@]server/[directory/] or tftp://server/[directory/]

### 7.7.7 APPLYING CONFIGURATION CHANGES

To apply new or changed configuration to RFP devices, select one or more RFP entries from the table and click the **Send Configuration** option in the task bar.

**Note:** You must close the Detail Data window to apply configuration changes to an RFP. If the Detail Data window is open, the **Send Configuration** option is disabled.

The OM Configurator displays the **Protocol settings** dialog window.

The settings in the **Protocol settings** dialog are preset to the values used for the **Scan** operation or the last **Send Configuration** operation. If the values are correct, click **OK** to transfer the data to the RFP device.

Before sending the data, the system performs a check on mandatory parameters and the validity of some parameter values. If this check fails, an error is reported in the Info console.

The system displays a message in the Info console window indicating success or failure of the data transfer operation for each RFP.

If data is transferred successfully, the OM Configurator displays a checkmark beside the row for the corresponding RFP.

The OM Configurator attempts data transfer three times (two seconds apart) before reporting an error. Depending on the network environment and current RFP status, the data transfer may fail in rare cases. If a failure to transfer data occurs, click the **Send Configuration** option again to re-initialize the data transfer.

If the data transfer fails, the OM Configurator displays an "X" beside the row for the corresponding RFP.

### 7.7.8 FACTORY RESET

RFPs are protected against unauthorized configuration changes by user authentication (user and password), which are also used to configure the OMM via web service or OMP.

To reset a RFP's configuration, select the RFP entry in the table and click the **Factory Reset** option in the task bar. This option is only enabled when a single RFP entry is selected. The option is disabled if multiple RFPs are selected.

The system displays the **Factory reset settings** dialog window. Set the correct login data (user and password) and RFP proxy address (if required). The system auto-fills the fields with the values used for previous **Scan**, **Send Configuration** or **Factory Reset** operations.

If the specified login ("omm"/"omm") does not work and the login credentials of the last system the RFP was used with are unknown, you can reset the RFP to factory settings by sending a cookie string to the OpenMobility manufacturer support and entering the received reset key. The OM Configurator copies the cookie string to the clip board.

### 7.7.9 SAVING AND LOADING A DECT BASE STATION LIST

You can save the configuration of one or more RFPs to a RFP configuration file. Select the RFP entries in the table and click the **Save RFP Config** option in the task bar. (Note that if the **Detail Data** window is active, the **Save RFP Config** option is disabled.)

RFP configuration data is loaded from the file and added to the OM Configurator database via the **Load RFP config** option. You must initiate the **Send Configuration** operation after executing the **Load RFP config** operation for the configuration to take effect on the select RFPs.

**Please note:** The data sequence has been changed from previous releases of the SIP-DECT OM Configurator. Import of files based on the old data sequence format may result in import errors or the incorrect assignment of parameter values.

### 7.7.10 REMOVING DECT BASE STATION ENTRIES

You can remove all RFP data records from the OM Configurator database through the **Clear List** option in the OM Configurator task.

You can remove one or more RFP records from the OM Configurator database by selecting one or more entries in the table and clicking on the **Remove selected RFP** option.

Ensure that you do not remove data records before configuration is sent to the RFP device (via the **Send Configuration** operation). Changes made to RFP configuration data but not sent to RFP device are lost on the remove operation.

You can add RFP configuration data again through the operations described above.

### 7.7.11 COMPATIBILITY WITH OLDER SIP-DECT RELEASES

It is not recommended to use the SIP-DECT 6.1 OM Configurator for configuration of RFPs with software from an earlier SIP-DECT release.

Configured parameters of an RFP which are unknown to actual OM Configurator are shown in the “Other parameter” panel with the name used at the protocol level. In most cases, this name will be different from the display name known from previous versions of OM Configurator.

You can edit or remove such parameters and new values will be transferred to the RFP when you execute the **Send configuration** operation.

## 7.8 OMM CONFIGURATION AND RESOURCE FILES

The OMM supports certain configuration files containing commands in AXI style, to support auto-configuration of small and simple installations in provider environments. It is assumed that the configuration files are automatically generated in a standardized way, to prevent configuration failures.

The following list summarizes all of the configuration and resource files related to the provisioning of a SIP-DECT system:

- ipdect.cfg / <MAC>.cfg / <PARK>.cfg

These files contain configuration parameters and are used to configure the OMM automatically. There is one common file “ipdect.cfg” for all RFPs and one file “<MAC>.cfg” for every single IP-RFP. The RFP specific <MAC>.cfg is requested if indicated in the common “ipdect.cfg” file. It is possible that all RFPs request “ipdect.cfg” and only selected RFPs request the <MAC>.cfg (for specific configuration on some RFPs).

- usr\_common.cfg / <user>.cfg

These files are related to the “External User Data Provisioning” feature, whereby <user> refers to <Number/SIP user name> or <LoginID>.

<user>.cfg can also refer to user.cfg, a common file name for all users. This concept allows a provisioning server to provide user-specific settings on demand using one file name based on the specific user credentials.

- ima.cfg  
This file includes the configuration for Integrated Messaging & Alerting Application, and can be loaded permanently.
  - iprpf3G.dnld  
This file includes the software image for RFP 35/36/37 IP / RFP 43 WLAN. This file also includes the software images for the Mitel 600 DECT phone family. RFPs can load their software image directly from the RFP OMM.
  - license.xml  
This file includes the license for a specific SIP-DECT system.
  - customer\_image.png  
This resource file can include a customer logo displayed to display on the OMM Web service.
- With SIP-DECT 6.0 or later, all of these files can be loaded from the same external file server, if configured (see section 7.8.1).

### 7.8.1 CONFIGURATION FILE URL

SIP-DECT supports provisioning through external configuration files. With SIP-DECT 6.0 or later, you can configure a URL for an external file server, from which all configuration files can be downloaded.

The configuration file server URL (ConfigURL) can be configured in the OMM (**System -> Provisioning -> Configuration file URL**), via DHCP or the Redirection and Configuration Service (RCS).

**Note:** If the external file server requires credentials for authentication, the credentials must be configured using the DECT phone or the Web service.

The following files are automatically requested if a provisioning server is set:

- Configuration files supporting startup parameters and OM AXI code for the OMM configuration
  - ipdect.cfg
  - <mac>.cfg (note that if a standby OMM is set, two MACs are present)
  - <PARK>.cfg (PARK in MAC address format: e.g. 001F11234001)
- User configuration files (for user login on DECT phone)
  - user\_common.cfg
  - <user.cfg>
  - user.cfg
- Integrated Messaging and Alerting Service (IMA) (for alarm scenarios, email accounts, RSS feeds) - ima.cfg
- OMM license file - license.xml
- Logo for OM Web-Portal (Branding) - customer\_image.png

You can also configure individual URLs for most configuration files. If present, the individual URL is used for the configured feature.

At startup, the OMM tries to retrieve the configuration file URL (ConfigURL) from the following sources, in the order listed. The OMM uses the first URL it finds to load the configuration and resource files.

The URL can be set through the following methods (in order of priority):

- 1 OMM database (e.g. **System > Provisioning > Configuration file URL** in either OMM Web service or OMP)
- 2 DHCP option 66 (SIP-DECT 6.2 or higher)
- 3 DHCP vendor specific option 43 – sub-option 2
- 4 DHCP option 234
- 5 Redirection and Configuration Service (RCS) – on initial setup only

Once a URL is set, it is stored in the OMM database. The URL can be overwritten at a later time e.g. during provisioning after authentication.

**Note:** The ConfigURL only applies to the RFP OMM, which must be running SIP-DECT 6.0 or higher.

Other DECT base stations only apply the ipdect.cfg and <mac>.cfg files without OM AXI.

### 7.8.1.1 Syntax

The ConfigURL has the following syntax:

```
<protocol>://<user>:<password>@<server>/<path>&<parameter>
```

- Supported protocols: ftp,ftps,tftp,sftp,http,https
- Credentials should be secured by transport protocol or digest authentication.

The ConfigURL supports additional parameters to modify the certificate validation behavior for the configuration file server:

- **cm:** <https client method > - TLS1.0, TLS1.1, TLS1.2 or AUTO (AUTO= all)
- **vc:** <validate certificates> - valid settings are: 0 or 1  
The OMM includes a list of trusted CA's (Mozilla CA certificate list )
- **ve:** <validate expires> - validation of certificate expiry: 0 or 1
- **vh:** <validate hostname> - validation of hostnames: 0 or 1
- **uc:** allow un-configured trusted certificates> - allow untrusted certs: 0 or 1  
If set to 1, validation is disabled as long as no trusted certificate was imported.
- **ic:** <import certificate> - import server certificate as trusted: 0 or 1  
If ic=1 + uc=1, the trusted certificate will be imported without any validation, as long as no trusted certificate was imported previously.

You can view and change the ConfigURL via the OMM Web service (see section 5.4.2) or the OMP (see section 6.5.5.1).

## 7.8.2 SPECIFIC CONFIGURATION URLS

In addition to the common ConfigURL, you can configure specific URLs for individual configuration and resource files in the OMM database. As soon as a specific URL is set, the OMM uses that URL to load the appropriate configuration/resource file during startup.

Note that the user\_common.cfg file is loaded from the ConfigURL and the specific URL when both URLs are set.



Configuration / Resource File	Location of Specific URL	
	OMM Web Service	OMP
user_common.cfg / <user>.cfg	N/A	<b>System &gt; Data management &gt; User data import</b> See section 6.5.7.2.
ima.cfg	<b>System &gt; System settings &gt; OM Integrated Messaging &amp; Alerting service</b> See section 5.4.1.	<b>System &gt; Advanced settings &gt; IMA</b> See section 6.5.2.4.
iprpf3G.dnld	<b>System &gt; System settings &gt; Software update URL</b> See section 5.4.1.10.	<b>System &gt; Basic settings &gt; Software Update URL</b> See section 6.5.1.4.
600.dnld	<b>System &gt; System settings &gt; DECT phone's firmware update</b> See section 5.4.1.6.	<b>System &gt; Advanced settings &gt; PP firmware</b> See section 6.5.2.3.
customer_image.png	N/A	<b>System &gt; Advanced settings &gt; Special Branding</b> See section 6.5.2.7

### 7.8.3 RELOAD OF CONFIGURATION AND RESOURCE FILES

The OMM automatically tries to load all configuration and resource files (ipdect.cfg, <MAC>.cfg, PARK.cfg, ima.cfg, user\_common.cfg, update check for iprpf3G.dnld, etc) from the retrieved ConfigURL or specific URL (if present in the OMM database) at startup.

**Note:** The <user>.cfg and user.cfg files are only loaded on demand. They are not loaded automatically.

In addition, the OMM supports several mechanisms for updating the configuration by triggering a reload of the configuration and resource files:

- DHCP lease time  
If the OMM is running on a RFP and DHCP is used, all configuration and resource files are reloaded when half of the DHCP lease time has elapsed.
- Daily automatic reload of configuration and firmware files  
You can enable this option and specify a specific time of day to reload configuration files via the OMM Web service or the OMP (System -> Provisioning -> Daily automatic reload of configuration and firmware files).
- Manual reload via **Update** button  
You can trigger a manual reload of all configuration and resource files by clicking the **Update** button in the OMM Web service (**System ->System settings** page ) or OMP (**System -> System settings -> General** tab).
- 600 DECT phone **Administration** menu
  - When a user with a 600 DECT Phone selects the **Sync system data** option in the **Administration** menu, the OMM reloads all configuration and resource files.
  - When a user with a 600 DECT Phone selects the **Sync user data** option in the **Administration** menu, the OMM reloads the <user>.cfg file for that user.
- SIP Notify message

- When the OMM receives a SIP Notify message with the “**check-sync**” event for a user, the OMM reloads the configuration file <user>.cfg for that user.
- When the OMM receives a SIP Notify message with the “**prov-sync**” or “**resync**” event for any user, the OMM reloads all configuration and resource files. The SIP Notify with “prov-sync” or “resync” can be also addressed to the OMM (without the user portion in the request URI).

## 7.8.4 AXI COMMANDS IN CONFIGURATION FILES

With SIP-DECT 6.0 or later, the OMM supports configuration files containing commands in AXI style, for OMM configuration.

The OMM attempts to load the following files from the Configuration File URL, and processes them in this order:

- 1 ipdect.cfg
- 2 <MAC>.cfg (RFP OMM only)
- 3 <PARK>.cfg (PARK in MAC address format: e.g. PARK: 1F11234001; MAC address format 001F11234001)

Note that the actual file name of the <MAC>.cfg depends on MAC address of the RFP where the OMM is running.

The active OMM and the standby OMM request different files, even if they belong to one system. To ensure that both OMMs can retrieve the same file independent of which one is active, each OMM requests the <PARK>.cfg. The PARK identifies a SIP-DECT system in a unique way.

None of the files are mandatory and they can be empty. The AXI commands can be all in one file or split up as needed.

### Example configuration file

The following example shows how to include AXI commands in a configuration file.

```
### SIP-DECT OMM Config example - pls. be aware that some commands cannot be applied to
SIP-DECT with Cloud-ID e.g. request PARK from server, set regulatory domain etc. and some
commands depend on the actual use case/setup

### Confirm EULA
<SetEULAConfirm confirm="1" />

### Set full access account
<SetAccount plainText="1" > <account id="1" password="Sip!12" active="1" aging="none" />
</SetAccount>

### Set root account
<SetAccount plainText="1" > <account id="2" password="Sip!12" active="1" aging="none" />
</SetAccount>

### Set system name
<SetSystemName name="6.1 NB" />

### Tone scheme
<SetSysToneScheme toneScheme="DE" />

### OMP web start #####
<SetOMPURL> <url enable="1" protocol="FTP" host="ber-rd5014" path="/pub/SIP-DECT/Linux"
/></SetOMPURL>

### Enable SSH ###
<SetRemoteAccess enable="1" />
```

```

### Request a valid PARK from a Server ####
<PARKFromServer />
### Set DECT Regulatory Domain ###
<SetDECTRegDomain regDomain="EMEA" />
### Set WLAN Domain/contry ###
<SetWLANRegDomain regDomain="DE" />
### Enable Auto-create on subscription ####
<SetDevAutoCreate enable="1" />
### Set DECT AC #####
<SetDECTAuthCode ac="35239" />
### Set specific user data URL #####
<SetUserDataServer plainText="1" useCommonFileNameOnServer="1" ><url enable="1"
protocol="HTTPS" host="www.domain.de" path="/lpueschel/test/" username="lpueschel"
password="lpueschel" validateCerts="0" /></SetUserDataServer>
### Set SIP Proxy and Registrar ###
<SetBasicSIP transportProt="UDP" proxyServer="172.30.206.9" proxyPort="5060"
regServer="172.30.206.9" regPort="5060" regPeriod="3600" />
### use addId="" for Login at DECT DECT phone #####
<SetDECT phoneLoginVariant login="ID" />
##### Set Portrange 17000 - 32767 #####
<SetPortRangeSIP ><userUdpTcp startPort="17000" endPort="17511" /><userTls
startPort="18000" endPort="18511" /></SetPortRangeSIP>
##### Set SOS/ManDown emergency number #####
<SetAlarmTrigger><trigger id="0" triggerId="SOS" fac="SOS" comment="" num="110"
/></SetAlarmTrigger>
<SetAlarmTrigger><trigger id="1" triggerId="MANDOWN" fac="MANDOWN" comment="" num="112"
/></SetAlarmTrigger>
### Set common voice mail number ###
<SetSysVoiceboxNum voiceboxNum="6333" />

```

**WARNING:** Configuration files must be automatically generated in a standardized way to avoid configuration failures. Configuration failures could cause a SIP-DECT system outage.

Note that this configuration file approach has limitations. For example:

- insufficient for managing data objects that are dynamically created and addressed by an index (e.g. RFPs)
- no administrator feedback for commands that cannot be processed (e.g., unknown commands, invalid parameter, conflicts which other configuration settings)

#### 7.8.4.1 User Data in Configuration Files

Configuration files are generally insufficient for managing data objects that are dynamically created and addressed by an index. Therefore, it is necessary to configure user data also. This allows providers to manage the user data (to a limited extent) without using the <user>.cfg files.

The <user>.cfg concept supports the complete range of user-related SIP-DECT functions, including a user-specific DECT phone configuration. The user data in configuration files as described here supports only a limited set of parameters.

To allow user data in configuration files, the following rules must be applied:

- 1 Initialize all possible data sets with default values Number/SIP user name is automatically set to uid<X> (e.g., uid1):

```
<CreatePPUser plainText=1 replaceData=1><user uid="1" name="" num="" addId=""
sipAuthId="" sipPw="" pin="" fixedSipPort="0" /> </CreatePPUser>

...

<CreatePPUser plainText=1 replaceData=1><user uid="512" name="" num="" addId=""
sipAuthId="" sipPw="" pin="" fixedSipPort="0" /> </CreatePPUser>
```

- 2 To “add” a user, set appropriate data:

```
<CreatePPUser plainText=1 replaceData=1><user uid="1" name="Account004 Mitel"
num="040226332195" addId="195" sipAuthId="040226332195" sipPw="broadnet.01" pin="195"
fixedSipPort="0" /> </CreatePPUser>
```

- 3 To “remove” a user, set to default data:

```
<CreatePPUser plainText=1 replaceData=1><user uid="1" name="" num="" addId=""
sipAuthId="" sipPw="" pin="" fixedSipPort="0" /></CreatePPUser>
```

This supports the use of templates such as the following:

```
<CreatePPUser plainText=1 replaceData=1><user uid="1" name="%BWNAME-1%" num="%BWLINERPORT-
1%" addId="%BWEXTENSION-1%" sipAuthId="%BWAUTHUSER-1%" sipPw="%BWAUTHPASSWORD-1%"
pin="%BWEXTENSION-1%" fixedSipPort="0" /></CreatePPUser>
```

## 7.8.5 USER CONFIGURATION FILES

The user configuration files (user\_common.cfg and <user>.cfg) enable the “External User Data Provisioning” feature, which allows customers to import user data from a provisioning server. See the *SIP-DECT OM DECT Handset Sharing & Provisioning Installation & Administration User Guide* for a full description of that feature.

In addition <user>.cfg can also refer to user.cfg, a common file name for all users.

SIP-DECT 6.0 introduced the *UDS\_CommonUserFileName* configuration attribute. When enabled, the OMM tries to fetch the same user.cfg file from the provisioning server for each user executing the login procedure, such that the login credentials of each user are used to access the provisioning server. This means that the provisioning server executes user authentication and provides a user-specific user.cfg when the user is authorized.

The *UDS\_CommonUserFileName* attribute is enabled/disabled via the user\_common.cfg file.

**Please note:** The common user file name feature is only applicable in combination with the file transfer protocols FTP, FTPS, HTTP, HTTPS or SFTP, which may require user/password credentials. Changing this attribute might cause login/logout problems for the users, because of changed authentication. It is up to the administrator to force user

logouts (delete users) optionally. In any case, the administrator must publish new authentication data to users for their logins and logouts.

Note that the *OM\_UniqueId=NUMBER/UID* variable in the *user\_common.cfg* file is no longer supported.

The following table summarizes the combinations of provisioning server access and type of user validation supported:

Provisioning Server access	Requested files	User validation	Supported DECT phones
<ul style="list-style-type: none"> <li>User data import URL</li> <li>User data import credentials</li> <li>No certificate validation</li> </ul>	<ul style="list-style-type: none"> <li>&lt;number   SIP user name&gt;.cfg</li> <li>&lt;loginID&gt;.cfg</li> </ul>	OMM authenticates user against PIN from .cfg files	<ul style="list-style-type: none"> <li>GAP</li> <li>Mitel 142d</li> <li>Mitel 600</li> </ul>
<ul style="list-style-type: none"> <li>User data import URL</li> <li>User data import credentials</li> <li>System Provisioning Certificate validation</li> </ul>	<ul style="list-style-type: none"> <li>&lt;number   SIP user name&gt;.cfg</li> <li>&lt;loginID&gt;.cfg</li> </ul>	OMM authenticates user against PIN from .cfg files	<ul style="list-style-type: none"> <li>GAP</li> <li>Mitel 142d</li> <li>Mitel 600</li> </ul>
<ul style="list-style-type: none"> <li>System Provisioning URL</li> <li>System Provisioning credentials</li> <li>System Provisioning Certificate validation</li> </ul>	<ul style="list-style-type: none"> <li>&lt;number   SIP user name&gt;.cfg</li> <li>&lt;loginID&gt;.cfg</li> </ul>	OMM authenticates user against PIN from .cfg files	<ul style="list-style-type: none"> <li>GAP</li> <li>Mitel 142d</li> <li>Mitel 600</li> </ul>
<ul style="list-style-type: none"> <li>User data import URL</li> <li>User credentials (UDS_CommonUserFileName=YES)</li> <li>No certificate validation</li> </ul>	<ul style="list-style-type: none"> <li>user.cfg</li> </ul>	Provisioning server authenticates user at file request with user credentials	<ul style="list-style-type: none"> <li>Mitel 600</li> </ul>
<ul style="list-style-type: none"> <li>User data import URL</li> <li>User credentials (UDS_CommonUserFileName=YES)</li> <li>System Provisioning Certificate validation</li> </ul>	<ul style="list-style-type: none"> <li>user.cfg</li> </ul>	Provisioning server authenticates user at file request with user credentials	<ul style="list-style-type: none"> <li>Mitel 600</li> </ul>
<ul style="list-style-type: none"> <li>System provisioning URL</li> <li>User credentials (UDS_CommonUserFileName=YES)</li> <li>System Provisioning Certificate validation</li> </ul>	<ul style="list-style-type: none"> <li>user.cfg</li> </ul>	Provisioning server authenticates user at file request with user credentials	<ul style="list-style-type: none"> <li>Mitel 600</li> </ul>

## 7.8.6 DIGEST AUTHENTICATION AND CERTIFICATE VALIDATION

The OMM supports system credentials for provisioning to retrieve configuration and resource files from a server that requires user/password authentication.

System credentials are used to retrieve files from the external provisioning server defined by the configuration file URL, for protocols supporting authentication or servers requesting authentication. For HTTP/HTTPS, basic and digest authentication are supported.

You can set the system credentials via:

- OMM Web service **System -> Provisioning -> System credentials** page (see section 5.4.2.2)
- OMP **System -> Provisioning -> System credentials** tab (see section 6.5.5.4)
- Mitel 600 DECT phone user interface (through Feature Access Code or the Administration menu)

System credentials are also inherited if sources other than the configuration file URL are configured for specific configuration or resource files, without credentials. The system credentials are used only if requested by the file server.

### 7.8.6.1 System credentials via Mitel 600 DECT Phone user interface

A Mitel 600 DECT phone user can set, change or delete system credentials from the Mitel 600 DECT phone via:

- a configured feature access code (FAC)
- the **Administration** menu on the user interface

**Note:** The user must log in to OMM before being allowed to change valid credentials. If credentials are not set or are invalid (indicated by a health state), the OMM login is omitted.

Setting the credentials via feature access codes requires configuration of a FAC number through the **System Features -> Feature Access Codes** menu of the OMM web service (see section 5.9.4) or the OMP (see section 0).

When the user dials the configured feature access code, the user can select between the “Create/Change” and “Delete” options. The Administration menu additionally offers a health indication (ok or not ok). Depending on the health state, the user may be forced to login to the OMM first.

## 7.8.7 DECT BASE STATION SOFTWARE IMAGE FROM RFP OMM

To simplify the upgrade process for existing SIP-DECT installations in provider environments, SIP-DECT 6.0 and later provides support for a feature that allows the RFP 35/36/37 IP / RFP 43 WLAN to load their software image directly from the connected OMM.

If the RFP 35/36/37 IP / RFP 43 WLAN has no valid URL from which to load the software, they attempt to load the software from the connected OMM. If the OMM is running on a RFP, the RFP OMM delivers the software to the connected RFPs.

A new software image for the RFP OMM can be provided as a iprpf3G.dnld file on an external file server. The software update URL can be configured via the OMM Web service (see section 5.4.1.10) or OMP (see section 6.5.1.4).

## 7.8.8 REDIRECTION AND CONFIGURATION SERVICE (RCS)

The Redirection and Configuration Service (RCS) simplifies SIP DECT installation and management. When the MAC address or the PARK of a SIP-DECT OMM is entered in the RCS server, a SIP-DECT OMM is routed to its assigned server for configuration upon initial start-up.

If the OMM does not find a ConfigURL during initial setup, the OMM contacts the RCS to request a ConfigURL, using its RFP MAC address. If the RFP MAC Address is configured in the RCS, the RCS provides a ConfigURL that points to an external provisioning server. The OMM attempts to load all configuration and resource files from the ConfigURL received from RCS.

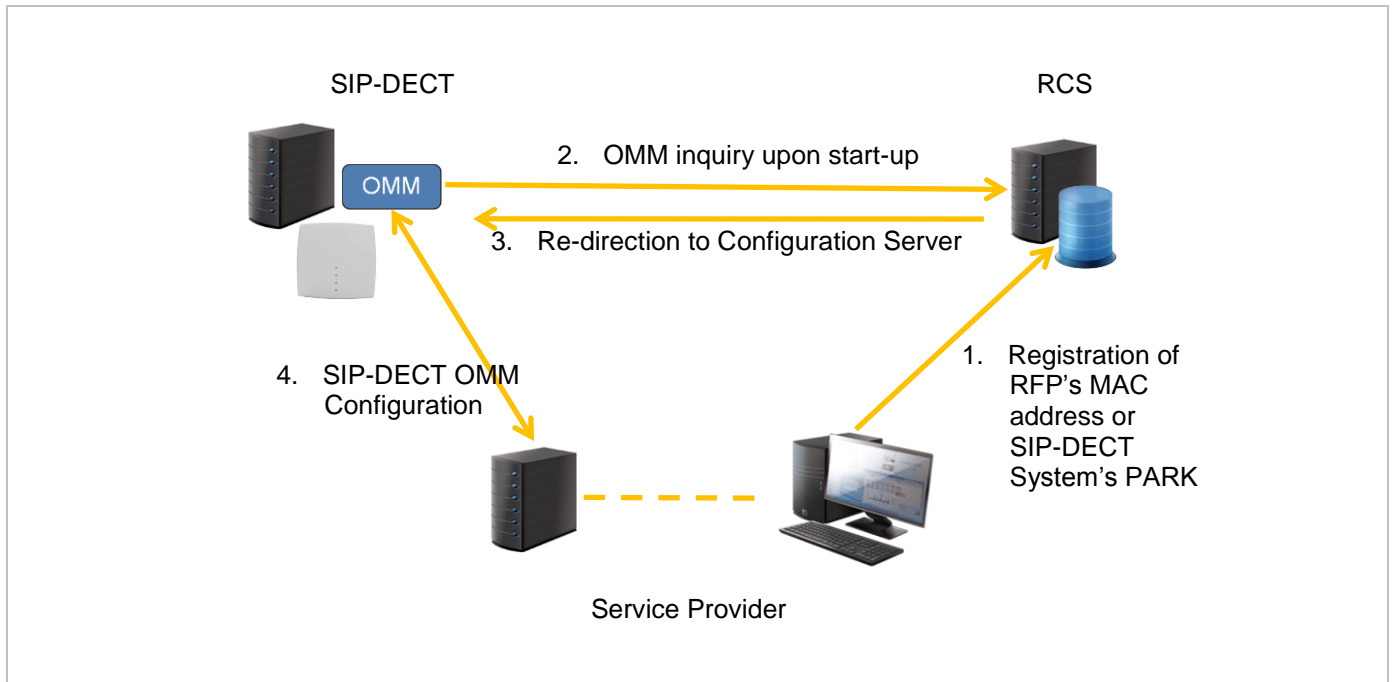

**Note:** The SIP-DECT OMM only uses the ConfigURL from RCS. Other information provided from RCS is not supported.

The OMM requests information from RCS only if no information has been retrieved from RCS prior to the request. The response is stored permanently in the OMM. To force a new RCS request, the OMM must be reset to default settings, through the **Discard OMM DB and configuration files** or **Reset OMM RFP(s) to factory defaults** on restart (see section 5.4.1.15).

## 7.8.9 CUSTOMER LOGO ON OMM WEB SERVICE

SIP-DECT 6.0 and later supports the integration of a customer-specific logo on the OMM Web service interface. If a customer\_image.png file is available on an external file server, customers can integrate their own logo into the OMM. This logo is displayed beside the Mitel logo on the top bar.

This image can be imported by:

- configuration of a branding image URL to a file server using OMP (see section 6.5.2.7)
- automatic search for a file named 'customer\_image.png' on the provisioning server

The branding image is stored permanently in the OMM database, ensuring that the image is available even if a configured file server or provisioning server is not reachable. The file is deleted automatically from the server on a "file not found" response or by disabling the branding image URL configuration.

The picture should not be larger than 50 pixels high and 216 pixels wide.

## 7.9 DECT BASE STATION CONFIGURATION FILES

IP-RFPs support two DECT base stations configuration files (downloaded from a server) to get configuration settings. There is one common file “ipdect.cfg” for all DECT base stations and one file specific file “<MAC>.cfg” for every IP-RFP. The DECT base station requests the “ipdect.cfg” file if a URL is provided. The RFP specific <MAC>.cfg is requested if this is indicated in the common “ipdect.cfg” file. It is possible that all RFPs request “ipdect.cfg” and only selected RFPs request the <MAC>.cfg to obtain a specific configuration on some RFPs.

### 7.9.1 STANDARD IP SETTINGS

Standard IP settings (which are necessary for access to the RFP configuration files) are configured via DHCP (see section 7.5) or OM Configurator (see section 7.6). These are:

- IP address
- Net mask
- Gateway (i.e. router)
- Boot file name
- TFTP server
- Public option 224: “OpenMobility” or “OpenMobilitySIP-DECT” (to identify the relevant DHCP offer)
- Domain Name Server (optional)
- Domain Name (optional)
- URL to the RFP configuration files

All other parameters can be set by using an RFP configuration file even if standard DHCP options or OM Configurator parameters exist.

### 7.9.2 CONFIGURATION FILE SOURCE

A TFTP / FTP(S) / HTTP(S) URL specifies the protocol, server and path to access the RFP configuration files. The URL can include account data if appropriate.

Syntax:

```
{ftp|ftps|http|https}://[user:password@]server/[directory/]
```

or

```
tftp://server/[directory/]
```

The URL configuration is provided via DHCP option code 223 (prio1), or the OM Configurator.

- “ipdect.cfg” is mandatory if an URL is provided by DHCP or local static configuration via the OM Configurator.
- “<MAC>.cfg” is mandatory if it is indicated in the “ipdect.cfg” that a “<MAC>.cfg” exists for the DECT base station. (There is a key word to indicate that a “<MAC>.cfg” exists for every DECT base station.)

Mandatory means that if a file cannot be loaded, the DECT base station does not start. This is relevant for the following scenarios:

- RFP boot / startup (after power on, software update, etc)
- a change of the URL



### 7.9.3 PARAMETER SETTINGS PRIORITY

Some parameters can be set via DHCP / OM Configurator or by using the files “ipdect.cfg” or “<MAC>.cfg”. If a parameter is provided through more than one of the possible ways, the last setting has priority. There is the following order:

- DHCP / OM Configurator
- ipdect.cfg
- <MAC>.cfg

It is also possible to remove settings.

### 7.9.4 SOFTWARE UPDATE SETTINGS FOR 3<sup>RD</sup> GENERATION DECT BASE STATIONS

A configuration parameter specifies the location of the software that will be installed into the flash of an RFP 35/36/37 IP / RFP 43 WLAN and activated by the OpenMobility Manager.

OM\_SwImageUrl=ftp://172.30.207.21/openmobility/iprfp3G.dnld

TFTP, FTP(S), HTTP(S) are supported for an RFP 35/36/37 IP / RFP 43 WLAN software update.

### 7.9.5 TIMES WHEN RFP CONFIGURATION TIMES ARE READ

The configuration files are read by the RFP application e.g. during startup as shown in the following figure.

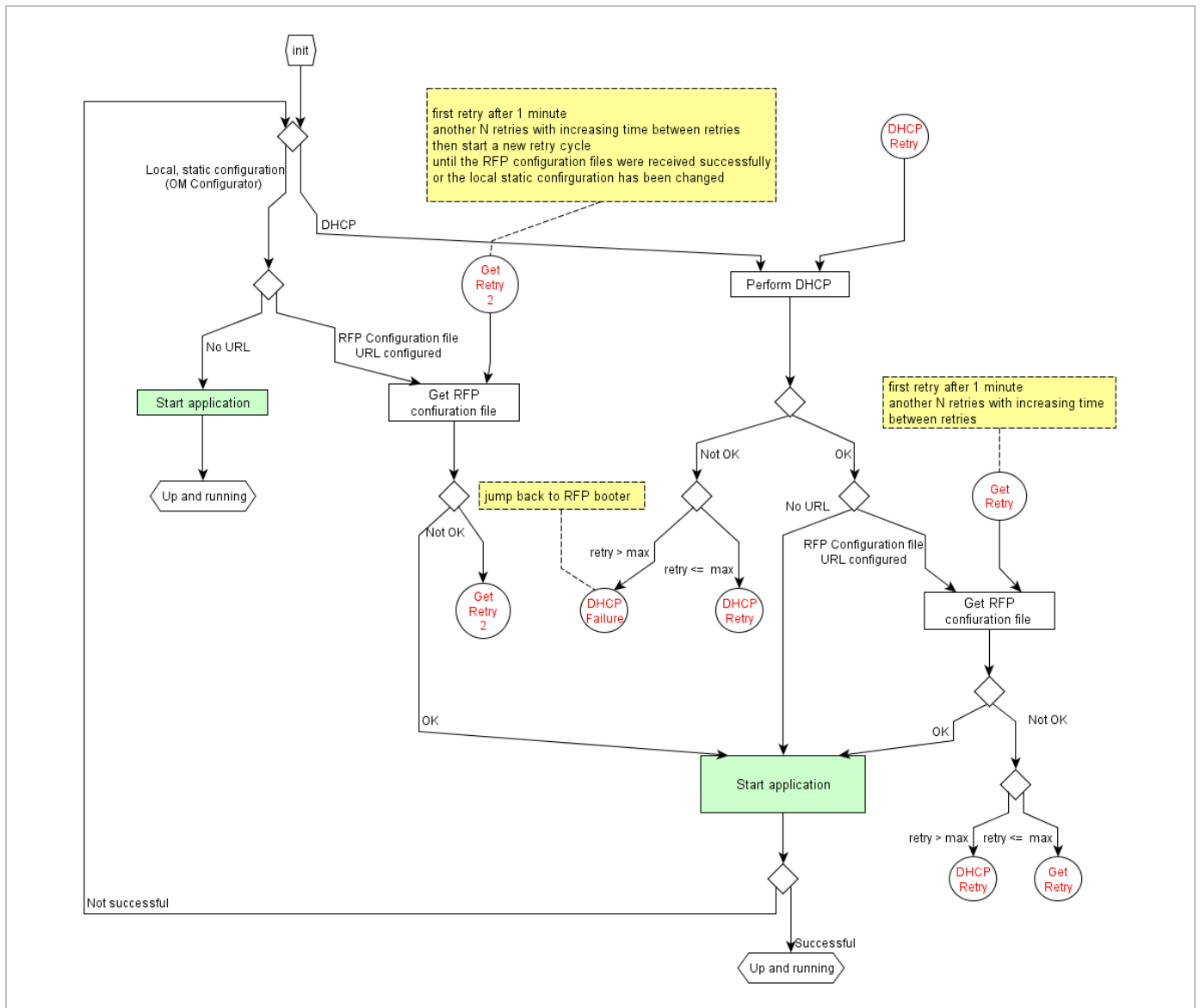

Configuration files are read by the RFP application at the following times:

- RFP reboot
- Restart of an application e.g. OMM
- DHCP renew and DHCP bound
- Configuration changes via OM Configurator
- RFP configuration file update check

### 7.9.6 RFP CONFIGURATION FILE UPDATE CHECK

RFP configuration file update check has the following characteristics:

- The interval is configurable in the RFP configuration files (minimum interval: 5 minutes; maximum interval: 7 days).
- Default interval: 24 hours.
- Both RFP configuration files are checked if relevant.

**If the configuration file(s) cannot be retrieved ...**

- The RFP continues operation with the last successfully retrieved configuration file(s).
- The RFP will try to retrieve the configuration files again, starting with an interval of one minute and doubling this interval with each retry, not exceeding the update check interval (either default or configured).
- If the RFP is using DHCP, a renewal of the lease is scheduled so that possible changes in DHCP configuration will be detected.
- Failure to retrieve the configuration files is reported via Syslog.

**7.9.7 HANDLING OF PARAMETER CHANGES**

A change of a parameter (DHCP / OM Configurator, RFP configuration files) does not necessarily mean a change to the RFP’s configuration because the parameter could be covered up or previously set using an alternative way.

**Example 1:**

IP address of a Syslog Daemon has been changed in “ipdect.cfg” but is covered up by “<MAC>.cfg” in which this parameter has not been changed.

**Example 2:**

A parameter is new in “<MAC>.cfg” but has been set previously in “ipdect.cfg” with the same parameter value.

Only if a parameter change causes a change in RFP configuration (as a sum of e.g. DHCP / OM Configurator, “ipdect.cfg” and “<MAC>.cfg” files) will the RFP perform a configuration update procedure. Depending on the changed parameter, an RFP configuration update is done:

- On the fly without any service interruption e.g. IP address of a Syslog Daemon has been changed.
- With an application restart e.g. OMM IP address has been changed.

**7.9.8 CONFIGURATION FILE SYNTAX**

```
#####
# sample configuration file for the OpenMobility system
# retrieved via the net using file transfer protocols
# like tftp, ftp, http, https, ftps
#
#####
# comments start with the hash sign: "#"
#
#####
# BOOL variables support the following values
# YES Y 1 TRUE (case does not matter)
# NO N 0 FALSE (case does not matter)
# other values are interpreted as false
#
#####
```

```
# personal configuration files
#
# personal configuration files have the following name
# <OWN-MAC>.cfg, where <OWN-MAC>.cfg is of the form
# e.g. 003042ABCDEF.cfg

# all RFPs will also load the <OWN-MAC>.cfg file
OM_PersonalConfigAll=1 # BOOL

# DO load the individual file for the RFP with mac 003042FFF0D0
# no matter what OM_PersonalConfigAll says
OM_PersonalConfig_003042FFF0D0=y

# DO NOT load the individual file for the RFP with mac 003042ABCDEF
# no matter what OM_PersonalConfigAll says
OM_PersonalConfig_003042ABCDEF=n # BOOL

# time interval for checking the remote cfg files in seconds
# minimum value is 300 (5 minutes)
# maximum value is 604800 (7 days)
OM_ConfigCheckInterval=500

#####
# OpenMobility system
#
# the OpenMobilityManager ip addresses
OM_ManagerIpAddress1=172.30.205.17
OM_ManagerIpAddress2=172.30.205.18

# path to the software image
OM_SwImageUrl=ftp://172.30.207.21/openmobility/sw/iprfp3G.dnld

#####
# SYSLOG
#
OM_SyslogIpAddress=172.30.207.20
OM_SyslogPort=10115

#####
# transfer core files to the following directory
#
OM_CoreFileSrvUrl=ftp://10.103.35.20/corefiles
```

## 7.10 CONSOLIDATED CERTIFICATE MANAGEMENT

SIP-DECT has various secured interfaces to support secure connections for file imports from local servers or provisioning servers. By default, the OMM Web server uses the hardcoded self-signed OMM certificate as local certificate for encrypted AXI connections, for provisioning (mutual authentication), and for SIP-over-TLS connections.

Certificate and authentication validation settings for these secure connections can be inherited from the configuration file URL (see section 7.8.1).

### 7.10.1 SIP OVER TLS CERTIFICATES

SIP over TLS certificates are used for secure SIP connections. The hard coded self-signed OMM certificate is used by default, however you can import trusted certificates, a local certificate chain and a private key file (optionally password-protected) via:

- OMP (**System** -> **SIP** -> **Security** tab)
- OMM Web service (**System** -> **SIP** -> **Security**)
- a certificate server (usually running on a Mitel call server)

### 7.10.2 OMM CERTIFICATE (WEB SERVICE / AXI)

The OMM Web server uses the hard coded self-signed OMM certificate by default as the local certificate for encrypted AXI connections.

You can overwrite the hard coded OMM certificate by importing a local certificate chain and a private key file (optionally password-protected) via the OMP (**System** -> **Advanced settings** -> **OMM Certificate** tab). You can also configure an OMM certificate server (**System** -> **Advanced settings** -> **OMM Certificate server** tab) to enable provisioning of OMM certificate files.

The OMM certificate will be used for incoming AXI and HTTPS connections to the OMM services. If the OMM can be reached from the internet by a domain and an appropriate CA certificate has been imported, no security warnings are displayed in web browsers trusting the CA root certificate.

### 7.10.3 PROVISIONING CERTIFICATES

Provisioning certificates are used for secure connections to configuration or firmware file servers with support for mutual authentication (i.e., for FTP, FTPS, and HTTPs protocols).

The OMM uses a trusted certificate chain to validate the server. This is required if the server has no certificate derived from a trusted CA root certificate, where the OMM uses the Mozilla CA Certificate List. If no server certificate is available, you can disable the validation against trusted and CA certificates.

By default, the hard-coded self-signed OMM certificate is used for mutual authentication. You can overwrite the hard coded OMM certificate by importing trusted certificates, a local certificate chain and a private key file (optionally password-protected) via:

- OMM Web service **System** -> **Provisioning** -> **Certificates** page (see section 5.4.2.5)
- OMP **System** -> **Provisioning** -> **Provisioning Certificates** tab (see section 6.5.5.2)
- a provisioning certificate server through OMP **System** -> **Provisioning** -> **Certificates server** tab (see section 6.5.5.3)

The OMM provides the local certificate chain and the private key to servers requesting mutual authentication. The private key file may be password protected.

The system credentials can be inherited if specific sources for configuration and resource files are configured, where the 'Use common certificate configuration' option is enabled.

## 7.10.4 CERTIFICATE VALIDATION

If the HTTPS or FTPS protocol is used to retrieve files from the configured provisioning server, the OMM validates the server certificates according to the certificate validation settings.

You can configure the certificate validation settings via OMP (**System -> Provisioning -> Provisioning - SSL settings**) or the OMM Web service (**System -> Provisioning -> Certificates**). Certificate validation settings can also be part of the ConfigURL provided by the RCS or via DHCP.

If you want to use the same validation settings for a specific URL (i.e., other than the configuration file URL), enable the "Use common certificate configuration" parameter when configuring the URL (unless the "Import certificates with first connection" parameter is enabled).

## 7.11 RFP 35/36/37 IP / RFP 43 WLAN SOFTWARE UPDATE

The DECT base station checks several locations for a software update. If found, the software is copied to the flash memory, leaving the current software intact. After successful installation, the OMM is notified about the new software. Activation of the software is then managed by the active OMM. DECT base stations that do not have a connection to the OMM activate and start the software immediately.

Locations for software updates:

- Attached USB mass storage device with a software image **iprfp3G.dnld** in its root directory. The USB mass storage device must be formatted using the vfat32 file system.
- If ipdect.cfg supplies the **OM\_SwImageUri** variable, the URI is used to get the boot image. Please see section 7.7.7.
- TFTP server, path and file configured using the OM Configurator or via DHCP.
- OMM (SIP-DECT 6.0 or later): If the RFP 35/36/37 IP / RFP 43 WLAN have no valid URL from which to load the software, they attempt to load the software from the connected OMM. If the OMM is running on a DECT base station, the RFP OMM delivers the software to the connected base stations. See section 7.8.7 for more information.

## 7.12 802.1Q SUPPORT

The IP RFPs support VLANs according to IEEE 802.1Q. VLAN can be administered

- on a per port basis of the LAN switch assuming that the IP RFPs are connected to a single port of a switched Ethernet environment, or
- by assigning a VLAN ID to the IP RFP matching the VLAN they should operate in.

VLAN tagging has only to be set to IP RFPs' in the last case. The whole section refers to that case. With this, also 802.1p priority within Ethernet frames is enabled.

The scope of the following description is restricted to VLAN tagging and obtaining the VLAN ID. Quality of Service mechanisms like 802.1p priority and DiffServ are not described in this section.

**VLAN implementation notes referring to IP RFPs:**

- IP RFPs are not able to support VLAN ID 0 as described later in this section. Any other valid VLAN ID can be configured.
- If a VLAN ID is configured, all traffic from an IP RFP will be tagged with this VLAN ID.
- The VLAN ID configured for an IP RFP is also used for the OMM running on this IP RFP.
- Once a VLAN ID is set to the IP RFP, incoming frames are only accepted if they are tagged as well. Therefore the switch port must be configured as a tagged trunk for this VLAN.
- The VLAN configurations can be done using DHCP or the interface for the local static configuration, the OM Configurator.
- The use of VLAN does influence the boot up process of the IP RFP because the VLAN configuration takes place during the boot up phase.
- The default setting is not to tag the traffic. 802.1Q tagging is enabled if the VLAN ID is set. If no VLAN ID is set 802.1Q is disabled.

**Why not VLAN ID 0 ?**

VLAN ID 0 means that the IP RFP's traffic belongs to the port/native VLAN. The Ethernet switch port to which the IP RFP is connected must be configured to accept 802.1Q tagging for this to work and the switch must interpret VLAN ID 0 as the port/native VLAN ID per the IEEE 802.1Q standard.

The packets from the IP RFP are tagged with VLAN ID 0 and the packets sent to the IP RFP are tagged with the port/native VLAN ID. This scenario does not work, because the IP RFP supports only one VLAN ID in both directions. That means the VLAN ID in the receive direction must be the same as the send direction.

**7.12.1 BOOT PHASE OF IP RFPs (DHCP)**

Because the IP RFP does not know about VLAN at the beginning of the start up, two DHCP scopes are required. This applies regardless of the Ethernet switch being used. The following scenario with arbitrary VLAN IDs' details the steps an IP RFP would go through in a typical dual-VLAN implementation.

**Step A. DHCP scope within the native VLAN:**

- 1 IP RFP boots up and obtains an address on the native VLAN.
- 2 The data VLAN DHCP option 132 directs the IP RFP to go to voice VLAN.

**Step B. DHCP scope within the voice VLAN:**

- 1 IP RFP releases the data VLAN address and obtains an address on the voice VLAN and all other parameters.

The voice VLAN does not have the DHCP option 132, because an IP RFP already on the voice VLAN does not need to be directed to go there.

- 2 IP RFP is operational on the voice VLAN.

If a reboot or power cycle occurs, the IP RFP returns to step A.

If an IP RFP cannot obtain an address on the voice VLAN, due to network or DHCP problems then the IP RFP falls back automatically to untagged frames (native VLAN).

To avoid the DHCP scope within the native VLAN the VLAN ID to be used can be set permanently via OMC without losing the ability to provide other parameter via DHCP, please see section 7.7.

## 7.12.2 BOOT PHASE OF IP RFPs (LOCAL CONFIGURATION)

The PC running the OM Configurator must be a member of the native VLAN for the first configuration, later on within the voice VLAN set.

If a wrong or unknown VLAN ID is set, you can overwrite or read the configuration using no VLAN tag on the switch port in the first six seconds after the RFP is connected to a power supply / PoE. After six seconds the RFP applies the local configuration and starts using the parameters.

## 7.13 INSTALLING OMM IN HOST MODE

In this case, the OMM software must be installed on a PC running Red Hat Enterprise Linux 6 or CentOS 6. The network parameters with which the OMM works in this mode depend on this PC's network configuration.

Once started, OMM works permanently on the PC. In case of fatal error or PC restart, OMM will restart automatically.

**Please note:** Check that the versions of the OMM and RFP software on your SIP-DECT installation are the same.

### 7.13.1 SYSTEM REQUIREMENTS

The OMM application is a 32-bit/x86 application that can be installed on a 32-bit or 64-bit (recommended) operating system. The PC-based OMM requires the following configuration:

- Red Hat Enterprise Linux 6 or CentOS 6 operating system
- Server hardware minimum:
  - Processor : Dual Core Intel® Xeon® 3065, 2.33GHz, 4MB cache
  - Bus 1333 MHz
  - Memory : 4GB DDR2 SDRAM 667 MHz
  - Hard disk: 80 GB SATA 7200 rpm
  - 1 GBit/s Ethernet interface

### 7.13.2 INSTALLING THE OMM SOFTWARE

The OMM software for the Linux Redhat server is provided as a self-extracting executable file (e.g., SIP-DECT\_6.1.bin). This binary file contains two Red Hat packages:

- SIP-DECT-OMM-<SIP-DECT-version>.i586.rpm  
OpenMobility Manager software.
- SIP-DECT-HANDSET-<DECT phone-version>.i586.rpm  
Software for Mitel 600 DECT phones

The Mitel 600 DECT phone software can be updated via the Air interface, see section 7.20. A separate software package can also be provided for specific updates of the DECT phone software.



**IMPORTANT :** Log in as “root” to install and/or update OMM. If you do not login as root to open the OMM console, the path to ommconsole is not set. You must enter the whole path “/usr/sbin/ommconsole” to start the OMM console.

### Command syntax

For extraction and automatic standard installation  
**sh SIP-DECT\_<version>.bin**

For extraction and automatic standard installation  
**sh SIP-DECT\_<version>.bin -f**

For extraction of RFP packages only  
**sh SIP-DECT\_<version>.bin -x**

RPM packages can also be installed manually.

For a first OMM type installation  
**rpm -i SIP-DECT-OMM-<version>.i586.rpm**

For an OMM software update (see section 7.14)  
**rpm -U SIP-DECT-OMM-<version>.i586.rpm**

For Mitel 600 DECT phone software installation  
**rpm -i SIP-DECT-HANDSET-<version>.i586.rpm**

To delete a software release  
**rpm -e SIP-DECT-HANDSET and**  
**rpm -e SIP-DECT-OMM**

To check an installed release  
**rpm -qi SIP-DECT-OMM**

or

**rpm -qi SIP-DECT- HANDSET**

After the installation phase, start OMM by running the command  
**“/etc/init.d/sip-dect-omm start”**

### 7.13.3 CONFIGURING THE START PARAMETERS

The basic data for initializing OMM is stored in the file “/etc/sysconfig/SIP-DECT”. It can be edited to modify the OMM interface.

```
#####
# OMM configuration file
#####
# if you use a different interface for omm activate/correct parameter below
#OMM_IF="eth0"
#
OMM_CONFIG_FILE=/opt/SIP-DECT/tmp/omm_conf.txt
#
#if you use OMM resiliency for OMM activate parameter below with OMMs IP addresses
#OMM_RESILIENCY="192.168.0.1:192.168.0.2"
#
# Automatic OMM database import:
```

# TFTP / FTP / HTTP(S) URL specifies the import server and file

Parameters	Description
OMM_IF	Interface for communicating with the RFPs (by default: eth0)
OMM_CONFIG_FILE	File that contains the OMM configuration (by default: /opt/SIP-DECT/tmp/omm_conf.txt)
OMM_RESILIENCY	In case of OMM redundancy, enter the two IP addresses of the OMMs. See also section 7.15.

### 7.13.4 SPECIFIC COMMANDS – TROUBLESHOOTING

The OMM software is installed but does not work automatically when the PC starts. The command below stops or starts OMM manually (User root):

```
/etc/init.d/sip-dect [start|stop|restart].
```

The command line interface for OMM is accessible via telnet on port 8107.

#### Malfunction

To check whether OMM is working, see the list of procedures for the “SIP-DECT” process. If OMM does not start, delete the lock file “/var/lock/subsys/SIP-DECT”.

To delete the OMM configuration remove the OMM configuration file “/opt/SIP-DECT/tmp/omm\_conf.txt” (by default).

## 7.14 UPDATING THE OMM

The procedures for updating an existing DECT installation with new software depend on

- whether a single OMM or standby OMM installation is used
- whether the OMM is running on an RFP or PC

The OMM “standby” feature is described in section 7.15.

The update mechanism allows an update of the RFPs with minimum impact to DECT services, especially for installations with a standby OMM.

All RFPs check the availability of a new boot image file automatically when:

- the DHCP lease is refreshed,
- the RFP lost the connection to the OMM,
- one of the service applications running on the RFP must be restarted, and
- an RFP configuration file update check is done (see section 7.7.7).

**Please note:** Make sure that all configured software sources point to the same software version, so that the OMM and all RFPs are running the same software version.

**Please note:** RFPs without a configured software image URL (via DHCP, OMC or ipdect.cfg/<mac>.cfg) retrieve their software directly from the OMM. In this case, the RFP activates the software immediately. This feature is only available with 3G RFPs.

As soon as an RFP detects a new boot image file on the TFTP server (or the software download server using FTPS or HTTPS), it notifies the OMM. The OMM keeps track when it is safe to restart an RFP in order to leave the DECT service synchronized.

RFPs scheduled for restart are marked with a yellow sign within the Web service (see section 5.6.1) or in a separate column within the OM Management Portal (OMP), see section 0.

**Please note:** Only software upgrades from the preceding two releases are tested for upgrade to the current release. Additional steps may be required to upgrade systems with software that is three or more releases behind the current release.

### 7.14.1 UPDATING A SINGLE OMM INSTALLATION

In the case of a single OMM installation, a DECT network outage during the update procedure is unavoidable.

**Please note:** Updating a single OMM installation results in a DECT network outage during the update procedure.

For the update, replace the boot image file on the TFTP server(s) with the new one.

#### OMM in RFP mode

If the OMM is running on an RFP, force the update of this RFP by pressing the **Update** button on the **System settings** web page (see section 5.4.1.16). The RFP checks the boot image file on the TFTP server and reboots if a new one is found.

#### OMM in host mode (on Linux server)

If the OMM is running on a dedicated Linux server, install the new software as described in section 7.13.2 on the PC with the command "**SIP-DECT\_<version>.bin**". This stops the running OMM automatically and installs the new software. After the installation phase, restart the OMM by executing the command "**/etc/init.d/sip-dect-omm start**".

As soon as the RFPs lose the connection to the OMM (because of the update), the RFPs detects that a new image file is on the TFTP server and reboot with the new image file.

### 7.14.2 UPDATING A STANDBY OMM INSTALLATION

**Please note:** Updating a standby OMM installation causes a switch over between both OMMs. All active calls will be dropped.

For the update replace the boot image file on the TFTP server(s) with the new one.

#### OMM in RFP mode

Force the update by pressing the **Update** button on the **System settings** web page (see section 5.4.1.16). The OMM-RFP checks the boot image file on the TFTP server and initiates an update procedure, if a new image file has been found.

The automated update procedure performs the following steps:

- 1 Reboot the RFP residing the standby OMM.
- 2 Reboot the RFP residing the active OMM which causes a failover to the standby OMM.
- 3 Reboot all other RFPs that are able to find the new boot image file one by one. This is managed by the new active OMM.

This procedure reduces the downtime of the SIP-DECT system to a minimum due to the optimized failover.

**Please note:** Please be aware that a minimum downtime of the system can only be reached if the system was in a stable working state when initiating the update and the IP infrastructure guarantees a fast update of the OMM RFPs (e.g., no 64kbit/s line to download the SW into the RFP).

### OMM in host mode (on Linux server)

For an update with a minimum impact to the DECT service do the following:

- 1 Replace the boot image file on the TFTP server(s).
- 2 Manually update the standby OMM.
  - a) Stop the OMM service.
  - b) Install the new software.
  - c) Start the OMM service.
  - d) Wait at least 30 seconds before you go on with updating the active OMM.
- 3 Manually update the active OMM.
  - a) Stop the OMM service.
  - b) Install the new software.
  - c) Wait at least 30 seconds.
  - d) Start the OMM service.

**Please note:** A one-by-one update of RFPs is not possible if the signaling interface between the OMM and the RFP has been changed. Please see the release notes delivered with the software.

To enforce an update of the whole DECT system at once, deactivate / update both OMMs simultaneously. The RFPs will lost the connection to both OMMs and will automatically restart with the new boot image file.

## 7.15 OMM STANDBY

To perform OMM standby, two OpenMobility Managers must be provided in an OMM network. One operates as the active OMM, and the other operates as the standby OMM.

In the event that the RFP designated as the OMM fails, the other RFP, designated as the secondary OMM automatically assumes the role of the OpenMobility Manager.

### How OMM Standby works

During system start-up, each RFP retrieves either one (if no standby OMM is configured) or two (if OMM Standby is configured) OMM IP addresses and both try to connect to each other. The active OMM serves all connections from RFPs or DECT phones.

During normal operations, both the active and the standby OMM are in contact and monitor each other's operational state. They continually exchange their current standby states and the standby OMM receives a copy of any configuration changes on the active OMM. As long as both OMMs are in contact, their databases are synchronized automatically.

If the primary OMM fails, the OMM responsibilities are taken over by the standby OMM to maintain operation. A "No Standby" warning is displayed on the OMM web interface, indicating that there are no longer two functioning OMMs in the network or cluster. Configuration changes are made unsafely in this situation.

If the active OMM fails, the inactive OMM recognizes this and begins to act as the active OMM, and starts the web service.

If the connection between the two OMMs fails, the network or cluster essentially breaks into two operational parts. The standby OMM becomes the active OMM. At this point, the two OMMs cannot detect one another and, therefore, cannot synchronize. When the connection between the two OMMs is re-established, the synchronization of the OMMs forces one OMM to become the standby OMM again. Once the recently failed OMM returns to service and becomes the inactive OMM, it does not resume the role of active OMM.

### 7.15.1 CONFIGURING OMM STANDBY

Each RFP of the DECT system must be configured with two OMM IP addresses. Both OMM addresses can be either configured via DHCP (see section 7.5.1) or with the OM Configurator (see section 7.6).

### 7.15.2 FAIL OVER SITUATIONS

Fail over occurs when:

- an OMM error occurs on the active OMM.
- the RFP acting as the active OMM is shut down or rebooted at the SSH console.
- the OMM is rebooted in the web browser menu.
- the active OMM is unreachable.

The standby OMM becomes the active OMM when:

- the configured SIP Proxy/Registrar is reachable.
- the other OMM has a larger IP Address while no OMM is active and both OMMs are in contact with each other (normally at system startup).

When the OMMs get in contact again:

- Both OMMs check which one ran for a longer period. That one will become the active OMM. The other one falls back to the standby one.

### 7.15.3 FAILOVER FAILURE SITUATIONS

Failover failure occurs when the connection between OMMs fails and the configured SIP Proxy/Registrar is unreachable. In this case the active OMM waits until the SIP Proxy/Registrar is reachable.

The following state diagram shows the OMM Standby states:

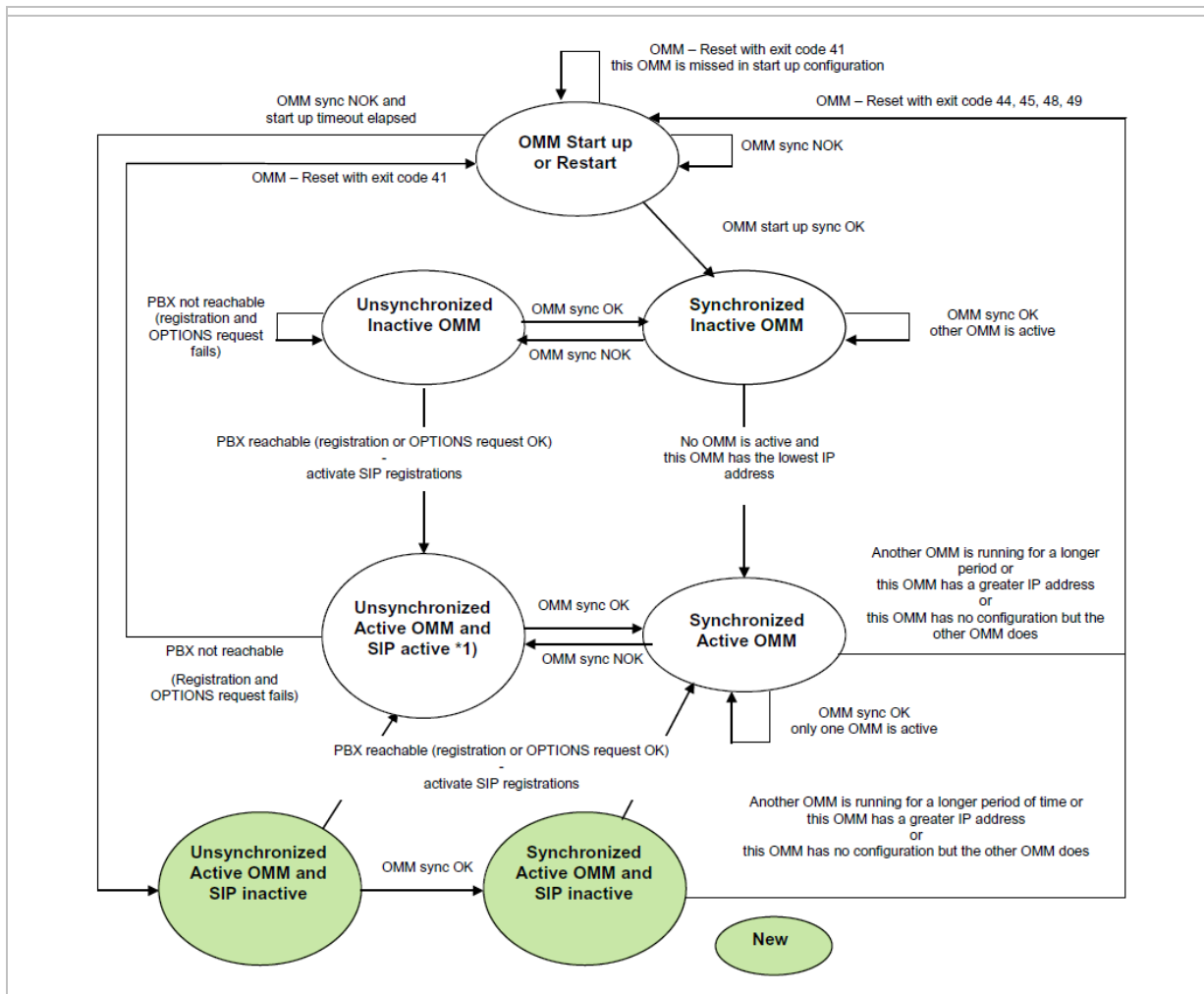

“OMM sync OK”: OMMs are synchronized and are able to exchange their operational states

“OMM sync NOK”: OMMs are not synchronized and are not able to exchange their operational states

\*1) In this state the DECT air interface might not be in a definite state as both OMMs are active but cannot connect with each other! This is caused by IP network failures and cannot be handled by the SIP-DECT system in a proper automatic way. In such a scenario it is not predetermined which RFP connects with which of the 2 OMMs. The DECT network can split-up into two unsynchronized DECT sub-networks. This can cause voice quality and handover problems.

With these states (“... SIP inactive”) the OMM standby mechanism takes care in the start up phase that all SIP users does not become active if the PBX is not reachable. This avoids a possible double SIP

registration when the PBX and the other OMM is reachable again before both OMMs negotiate which OMM becomes the active one.

The double SIP registrations might cause a user not to be reachable when his latest SIP registration came from that OMM that was negotiated to be the inactive one and the SIP registrar cannot handle two or more simultaneous registrations (non-forking proxy).

Similarly, it could happen in rare cases that both OMMs become temporarily active. In such a situation all SIP-DECT users would be SIP registered from both OMMs to the configured PBX. This can cause problems, if the PBX accepts only one registration per user (non-forking proxy).

To prevent such problems a mechanism is implemented to detect situations with two active OMMs. If such a situation is detected the remaining active OMM SIP re-registers all users to the PBX if the OMM **SIP reRegister after 2 active OMM failover** parameter is set (see section 5.4.3.6).

#### 7.15.4 SPECIFIC STANDBY SITUATIONS

Some aspects must be described in case of OMM state changes when they are unsynchronized.

##### 7.15.4.1 How a standby OMM becomes active

In an unsynchronized OMM state, the standby OMM must decide whether to become active or not.

The OMM tries to contact the configured SIP proxy and registrar. If a specific user account has not been designated to use for visibility checks (see section 7.20.7), the OMM starts a SIP registration for the DECT phone with the lowest phone number and sends an OPTIONS request to the configured proxy. If there is an answer the SIP proxy/registrar is considered reachable and the OMM becomes active.

##### 7.15.4.2 When OMMs are not synchronized

In an unsynchronized OMM Standby state, the connection between the OMMs is broken. In case of a network problem, both OMMs might be in this state. During this time an inconsistent OpenMobility system is operational with some constraints.

The OMM Web service issues a warning with the message “No Standby” for both OMMs and it is possible that configuration changes made are not saved.

When both OMMs are in contact again, the longer running OMM becomes the active OMM and overwrites the database file in the standby OMM. Configuration changes made in this OMM instance are lost.

##### 7.15.4.3 Two DECT air interfaces

When both OMMs are in an unsynchronized and active state, they are fully operational. DECT base stations that lose their connection to the OMM because of a network outage might connect to the other OMM. Two DECT air interfaces are present and work in parallel.

**Note:** Since both air interfaces use the same PARK, it is impossible to determine on which OMM a location registration succeeds.

For DECT phones different situations are possible:

- They do not notice this situation:
  - active calls stay established, depending on network conditions;
  - DECT phones can make and receive new calls, depending on an available PBX connection;
  - DECT phones can do handover to RFPs connected to the same OMM;
  - DECT phones can call DECT phones that are registered to the other OMM
- They lose their RFP base station and perform a new location registration:
  - active calls are broken;
  - DECT phones can make and receive new calls, depending on an available PBX connection;
  - DECT phones can do handover to RFPs connected to the same OMM;
  - DECT phones can call DECT phones that are registered to the other OMM;
- They lose their RFP base station and search the DECT network without finding another one:
  - active calls are broken;
  - DECT phones stay in searching for network until an air interface is available again.

**Note:** Handover between DECT phones located to RFPs that are controlled by different OMMs is not possible.

When the OMMs are in contact again, the inconsistencies are resolved.

## 7.16 USER DATA SYNCHRONIZATION (MIVOICE 5000 DUAL HOMING SUPPORT)

SIP-DECT 6.1 introduces support for user data synchronization to ensure that SIP-DECT telephony services survive if the network connection to the OMM goes down. The feature ensures user and device database redundancy among all OMM instances in the system.

When user data synchronization is enabled on an OMM instance, the OMM propagates changes in user, device, Configuration over Air (CoA) profiles or SARI configuration to a central OMM. AXI is used to distribute configuration changes between the central and peripheral OMMs.



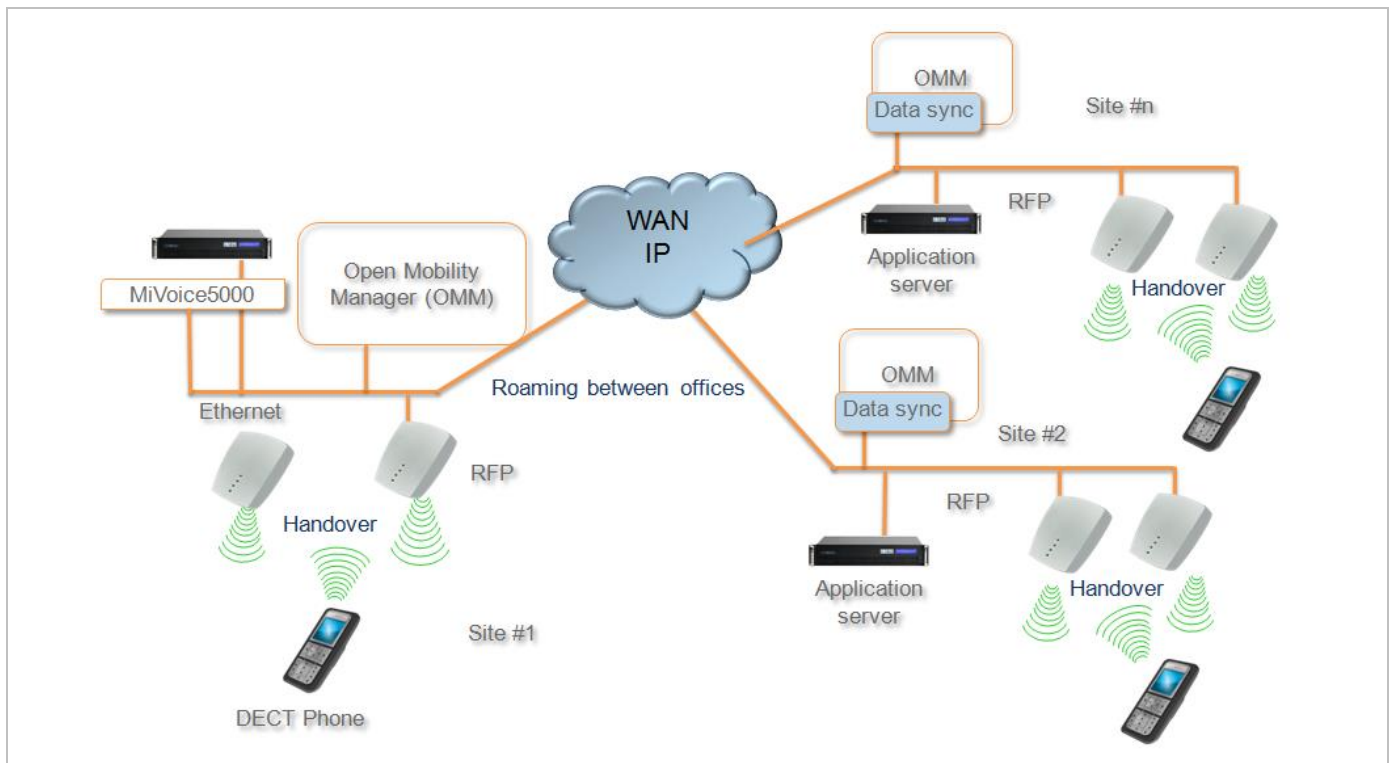

Instead of subscribing to the standard Primary Access Rights Key (PARK) of a single OMM when registering with the system, the DECT phones subscribe using the Secondary Access Rights Identifier (SARI) that applies to multiple OMMs in the system. All DECT phones that are subscribed to the system using the SARI can roam between sites (and OMMs). The PARK of the central OMM is defined to be the SARI.

**Please note:** Subscription to the SARI and successful roaming is only supported for Mitel 600 DECT phones. Behavior of third party GAP phones is not guaranteed. It is recommended that you add 3rd party GAP phones as fixed devices and configure them to subscribe to the "PARI only". See section 6.10.4.5 for more information.

All DECT phone users are registered to a central SIP proxy, used by all OMM sites (as long as the network environment is stable). OMM sites may implement local secondary SIP proxies, where local DECT phones register in case of a failed network connection.

## 7.16.1 ROAMING

The following sections describe the roaming concepts supported with the user data synchronization feature.

### 7.16.1.1 Device roaming

All DECT phones that subscribe successfully to the system SARI can roam between sites. Subscription to the system SARI is enabled by default when a DECT phone is created. SIP registration is renewed automatically with the OMM at the new site so that users can make and receive calls from all sites.

Unbound devices can also roam, but they are not SIP registered.

### 7.16.1.2 User roaming

Users with existing DECT phones can go to another site and log into an unbound DECT phone. The login to the old DECT phone is removed, and when the SIP registration is renewed, the DECT phone is registered with the OMM at the new site, so that the user can make and receive calls from there.

### 7.16.1.3 Move of SIP registration

The SIP registration follows the user's location, according to the following rules:

- When the change in site location is detected, the new OMM initiates a SIP registration.
- All other OMM sites are notified of the change, such that the OMM for the previous site does not renew the DECT phone SIP registration and broadcasts the change to all other OMMs.
- When the new OMM receives the update from the previous OMM, the SIP registration is repeated.

If there is any interruption in the user data synchronization, other OMMs are not notified of the change. In this case, the OMM at the new site initiates a SIP registration as soon as the change in site is detected. If the OMM does not receive an update within 30 seconds, the new OMM renews the SIP registration anyway.

When user data synchronization is restored, the appropriate notifications resume:

- The previous OMM does not renew SIP registration for the DECT phone and broadcasts the information to all other OMMs.
- The OMM at the new site repeats the SIP registration when the update is received.

**Please note:** If the OMM hosting an active Mitel DECT phone does not receive an updated location registration for the device for more than two hours, the OMM does not renew the SIP registration until the location registration is refreshed.

## 7.16.2 SETTING UP USER DATA SYNCHRONIZATION

Data synchronization is only implemented for user, DECT phone, and Configuration over Air (CoA) data. The SARI is copied from the central OMM to the peripheral OMMs. All other data must be configured on each OMM individually. If there are any configuration conflicts due to network connection failure, the user and device changes (that have the same key id) with the most recent time stamp are used.

To set up user data synchronization for your SIP-DECT system, you must:

- define the central OMM and generate a SARI for all OMMs to use when registering to the system
- configure links to the central OMM from every peripheral OMM in the system
- create a dedicated user account to verify standby OMM availability

### 7.16.2.1 Defining the central OMM

You must select an OMM to act as the central OMM for user data synchronization. When you have selected the OMM, generate the SARI from the OMM's PARK value (via the OMP **System** -> **Basic settings** -> **DECT** tab). See section 6.5.1.2 for configuration details.

All Mitel 600 DECT phones registered with the OMM can then roam to all other OMM sites (which may be added later).

### 7.16.2.2 Configuring links to the the central OMM

Each peripheral OMM in the system must connect to the AXI interface of the central OMM for user data synchronization. If a standby configuration is used for the central system, both OMMs must be configured in the peripheral OMMs. You configure the connection to the central OMM via the OMP **System -> Data management -> DECT phones synchronization** tab (see section 6.5.7.3 for configuration details).

Before you link a peripheral OMM to the central OMM, you must delete all user and device data, and CoA profiles from the local OMM. After the connection is established, verify that the user and device data from the central OMM have been received, then reconfigure the deleted users and devices.

**Please note:** Concurrent configuration of user and device data may cause conflicts. This can happen if one or more OMMs are not visible due to network issues. If conflicts are detected for user or devices with the same key Id, those with the most recent timestamp are kept.

SIP-DECT provisioning mechanisms ensure that there are no conflicts with user data synchronization. However, the system cannot regulate operations such as "auto-create on subscription". Under rare circumstances, conflicts can arise with the result that a user action may be ignored. Repeat the action to ensure it is registered by the system.

You must also ensure that the calling party numbers do not conflict with any conference room, FAC prefix or alarm trigger number across all OMMs in the system.

**Please note:** The user data synchronisation mechanism does not validate conference room, FAC prefix or alarm trigger numbers. If such numbers conflict with a user's calling number, synchronisation terminates immediately.

### 7.16.2.3 Creating a user account for standby visibility checks

If the active or standby OMM loses connectivity, each OMM checks connectivity to the SIP proxy. By default, a real SIP user account is used to check the availability of the OMM (via a SIP registration to the SIP proxy). In a dual homing environment, this may impact the user's telephony services due to the data synchronization.

To avoid this issue, you must create a virtual SIP user to be used exclusively for checking OMM availability (one account for the entire system). See 7.20.7 for more information on this feature.

## 7.16.3 USER DATA SYNCHRONIZATION MODES

The user/device synchronization runs on every peripheral OMM with a configured link to the central OMM. The synchronization function requires an internal AXI connection and an external AXI connection to the central OMM.

There are two synchronization modes: system startup or reconnection to resolve conflicts and copy new or changed datasets, and dynamic synchronization mode.

### 7.16.3.1 Start-up / reconnection mode

In start-up/reconnection mode, the user data synchronization service reconciles the data in the peripheral OMMs and central OMM. The steps in the user data synchronization mechanism are:

- 1 Read user/device data and profiles from internal AXI.
- 2 Read SARI from external AXI.
- 3 Set SARI on internal AXI.
- 4 Read user/device data and profiles from external AXI.
- 5 Resolve conflicts.
  - **Inconsistent associations** (one device bound to two different users): association is deleted on the system with the older user/device timestamps. An unbound user remains.
  - **Inconsistent number** (two different user datasets using the same number): the user with the older timestamp is deleted (including any existing device associations)
  - **Inconsistent additional ID** (two different user datasets with the same additional ID): the user with the older timestamp is deleted (including any existing device associations)
  - **Inconsistent association** (one user bound to two different devices): association is deleted on the system with older user/device timestamps. An unbound device may remain if an IPEI was configured, otherwise the device is deleted.
  - **Inconsistent IPEI** (two different device datasets with the same IPEI): the device with the older timestamp is deleted (including any existing user associations)
- 6 Copy data.

Data with the most recent timestamp is copied to either the peripheral OMM (if data in the central OMM is more recent) or the central OMM (if data in the peripheral OMM is more recent), including:

  - profile datasets with newer timestamps
  - changed users with newer timestamps (with the device dataset, if bound)
  - new users (with the device dataset, if bound)
  - changed unbound devices with newer timestamps
  - new unbound devices

### 7.16.3.2 Dynamic mode

In dynamic synchronization mode, events related to new, changed, or deleted users/devices received from one OMM are applied on the other OMM.

In rare cases, when configuration changes are made on multiple OMMs simultaneously (e.g. by configuration via OMP/Web, login/logout on devices, auto-create on subscription, etc), thereby creating new conflicts, the user data synchronization service closes the AXI connections and restarts after a minute to initiate a new synchronization.

## 7.17 MANAGING ACCOUNT DATA FOR SYSTEM ACCESS

Each RFP provides different independent access types:

- the OMM Web service/HTTPS interface (see section 5);
- the OMP (see section 6);

The OMM Web service and the OMP are mainly used for configuration and administration.

- the OM Configurator (see section 7.6);

The OM Configurator is mainly used for static local configuration of an RFP.

- the SSH user shell (see section 8.3.5).

The SSH user shell is mainly used from experts for diagnosis.

Each of these access types uses the same account data.

The account data can be altered at the **User account** page of the OMM Web.

The OMM delivers all the necessary account data to all connected RFPs. The RFPs save the account data inside their permanent memory. This has some implications:

- An RFP out of the box uses the default account data as long as this RFP is not connected to the OMM.
- An RFP which was connected for at least one time with the OMM uses the account data from the OMM.
- When the account data are changed on the OMM, any not connected RFPs will continue to use the older passwords.

### 7.17.1 ACCOUNT TYPES

There are three different account types:

- **Full access:** This access type is the “normal” access for the configuration. Using this access it is allowed to configure the OMM and each RFP. On the SSH interface of an RFP this access type allows login for debug information e. g. “pinging” another RFP to check visibility.

The factory setting for this account is

Name: 'omm'

Password: 'omm'

Active: 'n/a'

- **Read-only access:** As the name suggests this access type is not allowed to configure any item of the OMM installation. This access type can only be used on the OM Web service. The account can be deactivated.

The factory setting for this account is

Name: 'user'

Password: 'user'

Active: 'yes'

- **Root (SSH only) access:** This access type is only applicable on the SSH interface of an RFP. Its purpose is to get detailed information e. g. parameters from the kernel. The access using this account type is not reachable from other hosts hence a login using the full access type is necessary.

The factory setting for this account is

Name: 'root'

Password: '22222'  
Active: 'n/a'

**Please note:** It is highly recommended not to use the “Root (SSH only) access” account type. It is meant for technical support only.

## 7.17.2 POTENTIAL PITFALLS

When an RFP is configured via the OM Configurator and is taken out of an installation, the RFP may become unusable:

- When this RFP comes up, it finds a valid configuration in its permanent memory. It will hence skip DHCP for booting.
- But when this configuration is not valid anymore (e.g. the TFTP server has a new IP address meanwhile), the RFP isn't able to complete the boot and is hence not able to connect to the OMM.
- The RFP will not get newer passwords from the OMM.

It is therefore recommended to switch of the OM Configurator before taking an RFP out of an installation. But nevertheless the OM Configurator allows to reset the permanent memory of an RFP (the Mitel support must be connected).

## 7.18 WLAN CONFIGURATION (RFP 42 WLAN / RFP 43 WLAN ONLY)

### 7.18.1 WLAN CONFIGURATION STEPS

The correct configuration of an RFP with a WLAN interface requires the correct configuration of the DECT part. The second step is to specify the **Regulatory domain** of the WLAN network at the **System settings** page of the OMM web service (see section 5.4.1.3).

**WARNING:** Please note that selecting the incorrect regulatory domain may result in a violation of applicable law in your country!

Select one of the two-letter country codes. This setting depends on the country and is prescribed by the laws of that country. Only the setting prescribed for that country must be used.

The third step is to specify the WLAN parameters in a profile (see section 5.8.1). The WLAN profile determines the name (SSID) of the WLAN network and other parameters. The encryption and authentication procedures are especially important and must be planned carefully beforehand.

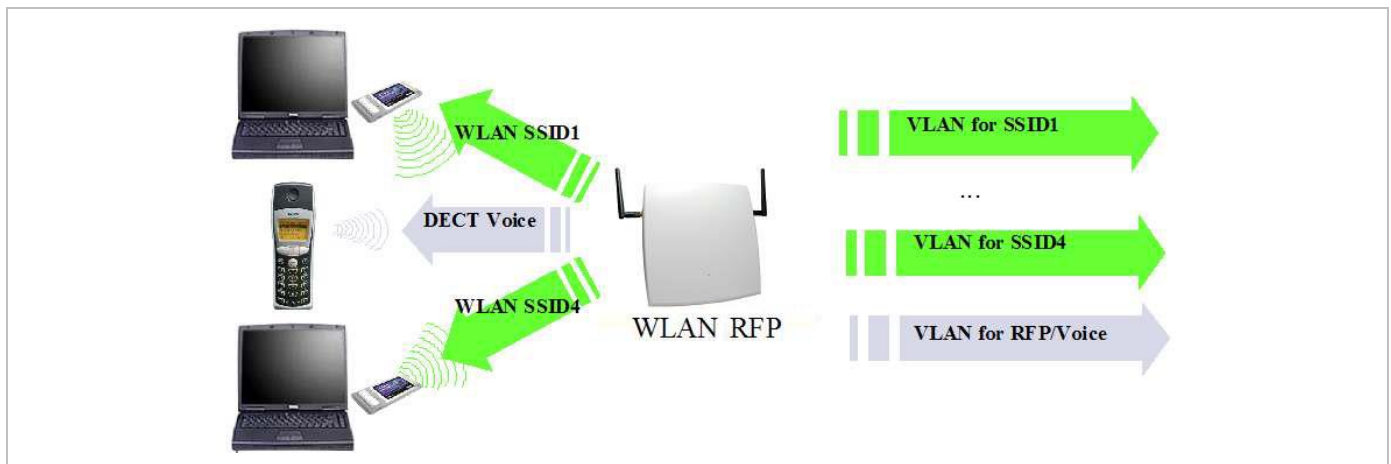

The access point can be assigned to a VLAN that conforms to 802.1q. All the data that is received from and that is to be forwarded to the WLAN clients is then carried by the configured VLAN. All other data, such as VoIP packets, configuration data or authentication data (Radius), is given the VLAN tag configured for the RFP. The switch port of the network component to which the access point is connected must be configured as a trunk port.

**Note:** The RFP 42 WLAN and RFP 43 WLAN must be connected at least via a 100BaseT Ethernet link in order to activate the RFP's WLAN function.

As a fourth step, you must assign a WLAN profile to a configured RFP. This can be done on the **DECT base stations** page of the OMM web service or on the OMP **DECT base stations** -> **Device list** page. Note that specific radio settings for the RFP, such as the channel-, 802.11abgn mode-, or antenna settings, are also done in this step.

## 7.18.2 OPTIMIZING THE WLAN

### Beacon Interval

Transmitting beacons requires transmission channel capacity. A shorter beacon interval increases the WLAN network's ability to detect signals, thus improving its availability. At the same time, it increases the network's ability to adjust the mutually negotiated signal strength. A longer beacon interval saves WLAN air time and also reduces the power consumption of mobile WLAN clients.

### RTS Threshold

If the network throughput is low or if many retransmissions occur, the RTS/CTS handshake can be activated by reducing the RTS threshold value below 1500 bytes. This can improve throughput, especially in environments where reflection and attenuation cause problems for HF.

### Fragmentation Threshold

In environments where there is a lot of interference and poor radio quality, reducing the fragment size below 1500 bytes can improve the effective throughput. However, transmitted data frames must be fragmented, which means a higher load on the RFP's processor.

**DTIM Period**

The DTIM period specifies the interval between transmissions of the broadcast and multicast packets. All WLAN clients must be active during this interval. Increasing the DTIM period lowers the client’s power consumption slightly. Not all programs can manage the increase in response times, however.

**Channel Allocation**

Every WLAN RFP must be configured to a channel. You should ensure that the channel settings do not overlap. WLAN RFPs within range of each other should be configured at least five channels apart. When the radio field is planned, the WLAN RFPs of foreign WLANs that may be operating in the vicinity must be taken into account.

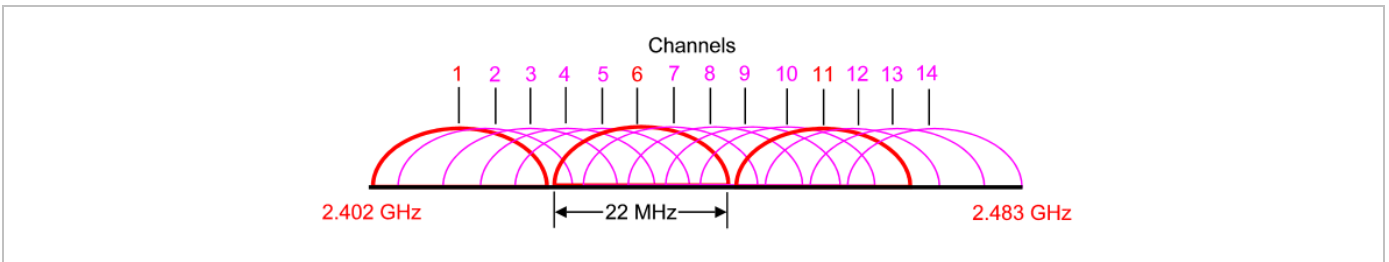

When planning the radio coverage for a two-dimensional area, please bear in mind that the distance between any two base stations operating on the same frequency must be at least twice their range. The range can be adjusted by lowering the output power level.

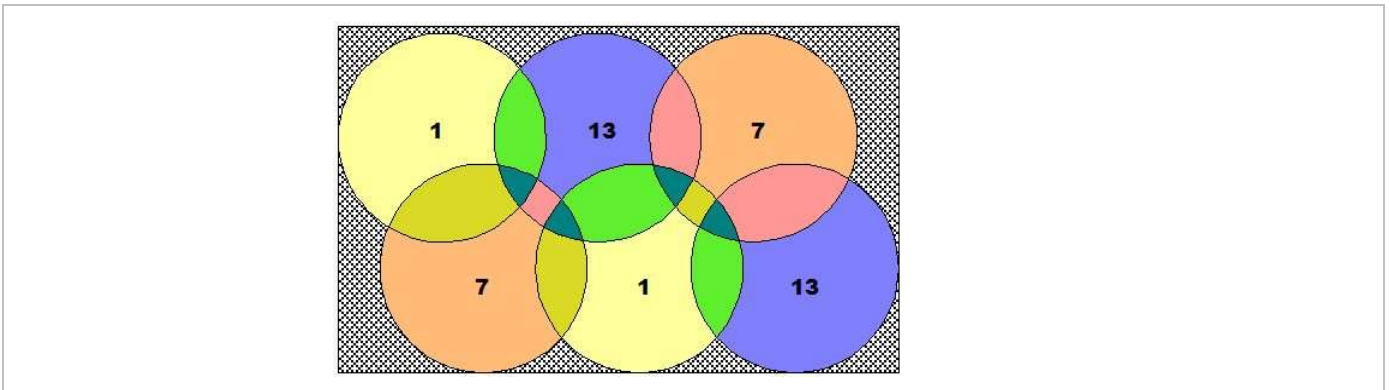

**802.11i: WPA2-Enterprise Pre-Authentication for fast Roaming**

WLAN stations (e.g. laptop) which decide to roam to another WLAN access point (AP) must perform the full authentication process with the new AP. In 802.1X (RADIUS) networks this can take a long time resulting in network dropouts during the roam.

The AP share authentication information with other APs, so the station can authenticate faster (pre-auth) when roaming to a new AP. This method reduces network dropouts significantly.

The RFP43 automatically enables pre-authentication for WPA-Enterprise enabled WLANs. The RFP42 does not support this feature.

**Channel Configuration Feedback for HT40 and Transmit Power**

The HT40 channel configuration in 802.11n enabled networks may not always become active because of other access points that use channels that would overlap. In this case, the RFP43 will fall back to HT20.

The effective channel configuration and the transmit power are reported to the OpenMobility Manager.

Users can inspect these parameters using the WEB interface and the OMP and may change the channel to a frequency without overlapping APs.



### 7.18.3 SECURING THE WLAN

In order to ensure that communication in the WLAN network is secure, several measures must be taken. Firstly, data packets transmitted via the openly visible radio interface must be encrypted, and secondly, all WLAN components that provide services must authenticate themselves.

There are different encryption methods available that you configure within the WLAN profile (see section 5.8.1). However, only the recent WiFi protected access (WPA) encryption offers sufficient security against possible intruders. You should not use the (older) WEP encryption for your company LAN.

Especially with larger WLAN installations, the single shared secret offered by WPA-personal may not be sufficient for your security requirements, because any person that connects to the WLAN needs to know the same shared secret. For this reason, you should also setup RADIUS authentication that is supported by all RFP 42 WLAN and RFP 43 WLAN devices.

A Radius Server (Remote Authentication Dial In User Service) handles 802.1x Authentication, thus authorizing different WLAN clients with an individual username / password combination to log in. We recommend a Radius Server with EAP-TLS (e.g. FreeRadius or MS Windows 2003 IAS Server) and a Certificate Authority (CA).

The RADIUS authentication takes place between the RADIUS server and the RADIUS client, with the WLAN RFP to pass-through this communication. You should refer to the documentation that comes with your RADIUS product for details on how to setup, maintain and operate the RADIUS system.

## 7.19 SNMP CONFIGURATION

To manage a larger RFP network, an SNMP agent is provided for each RFP. This will give alarm information and allow an SNMP management system (such as “HP Open View”) to manage this network. The SNMP agents can be configured in the **SNMP** menu of the OM Web service (see section 5.4.6).

All SNMP agents are configured by the OMM. Additional parameters that are valid for the individual RFP (e.g. “sysLocation” and “sysName”) are generated. The “sysLocation” parameter corresponds to the location configured via the OMM web interface. The “sysName” parameter is generated using the MAC address and the RFP device type (e.g. RFP 43 WLAN). The RFP uptime can be requested by reading the “sysUpTime” parameter. This value indicates how long the RFP application software is running. It does not indicate the uptime of the operating system which does not correspond to the operational RFP state.

The SNMP agent responds to SNMPv1-read and SNMPv2c-read requests for the standard MIB-II objects. The Management Information Base (MIB-II) contains 11 object groups. The agent receives both SNMPv1 and SNMPv2c traps. It sends a “coldStart” trap when it first starts up. It also sends an enterprise-specific trap “nsNotifyShutdown” when it stops. When the SNMP agent receives an SNMP request using an unknown community name, it sends an “authenticationFailure” trap. The SNMP agent also generates an enterprise-specific trap “nsNotifyRestart” (rather than the standard “coldStart” or “warmStart” traps) after being reconfigured.

## 7.20 BACKUP SIP PROXY/REGISTRAR

This section provides an overview about the supported redundancy concepts with SIP-DECT to realize a high availability solution together with IPBX redundancy mechanism.

The focus of this section is IPBX redundancy. For information regarding OMM redundancy, see section 7.15.

### 7.20.1 REGISTER REDIRECT

To allow IPBX systems to spread the registration and call traffic over different servers the OMM supports 301 (Moved Permanently) or 302 (Moved Temporarily) responses for registrations.

When a 301 or 302 response is received, the OMM follows the redirect and registers the concerning user to the given address. If more than one contact address are given in the 301/302 response, the OMM tries to contact the registrars successively until the registration succeeds.

If the redirected register succeeds and if the configured proxy and registrar are identical, all subsequent INVITE requests are sent to the redirected server. In the other case all subsequent INVITE requests will be sent to the (outbound) proxy or secondary/tertiary (outbound) proxy.

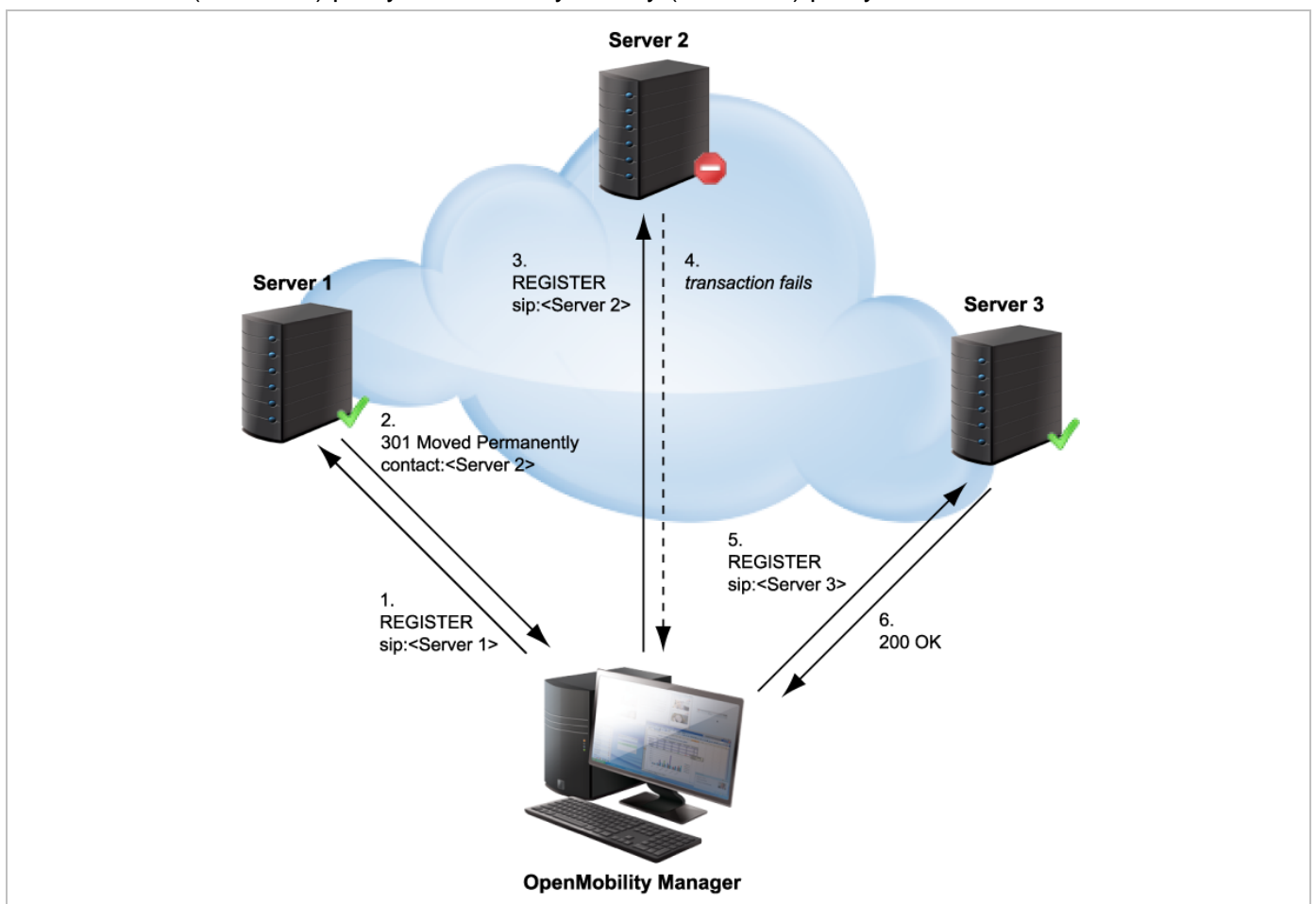

### 7.20.2 DNS SRV

If a full qualified domain name is configured as proxy, outbound proxy or registrar server and the respective port setting is set to zero ("0"), the OMM performs a DNS SRV query before an appropriate

SIP transaction is started. Herewith the OMM locates a list of servers responsible for the given SIP domain. With this configuration, the default port (“5060”) is used for every server address acquired with this mechanism.

The DNS SRV results are sorted by priority and weight in ascending order by the OMM. As soon as the DNS SRV query succeeds, the OMM starts the appropriate SIP transaction by sending the request to the server with the uppermost priority and weight of the DNS SRV result.

If there is no answer from the first SIP server in a configurable time frame (“Transaction Timer” parameter), it will be assumed as unreachable and the OMM tries to contact the next server of the DNS SRV result. Therefore the request will be send to the second server of the DNS SRV query result. If there is also no answer in the given time frame from the second server, the request will be send to the third server and so on. When there is an answer from one of the contacted servers, this server will be used for this transaction.

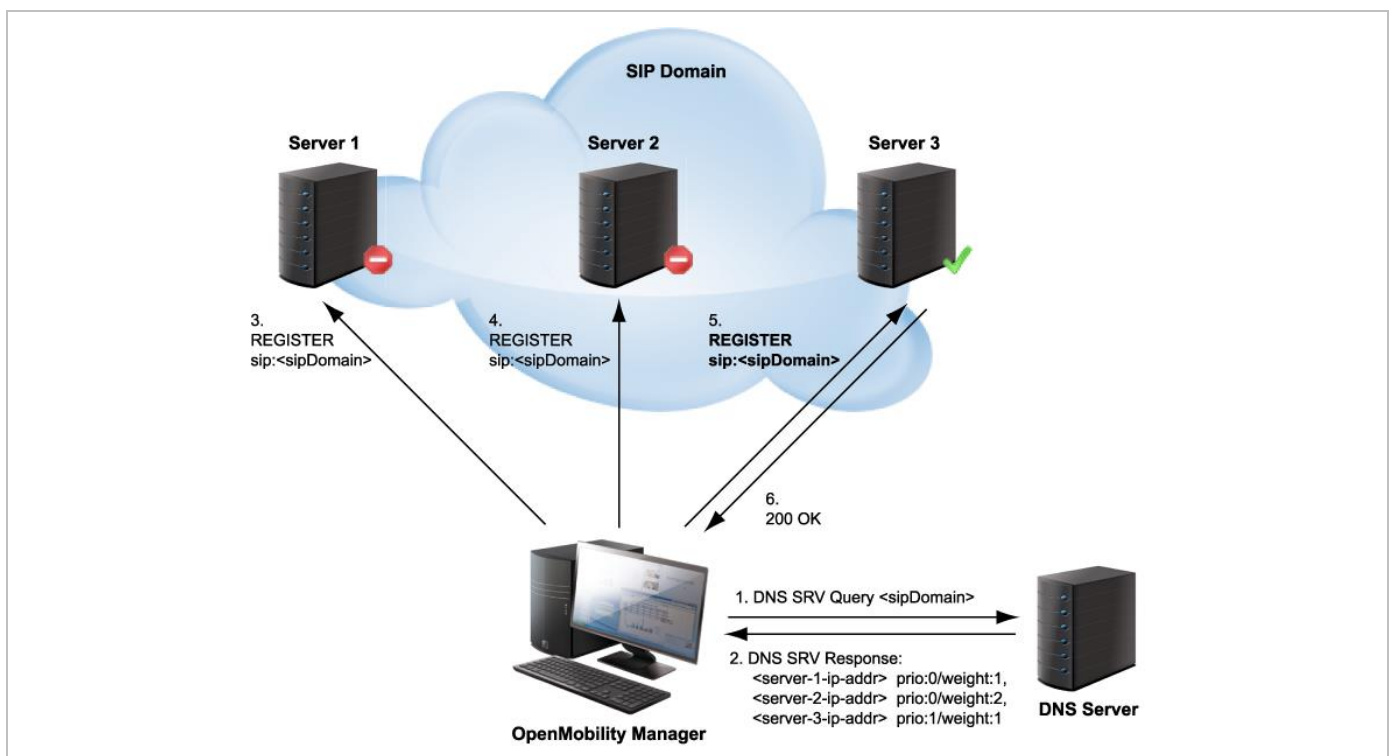

To prevent situations where the OMM tries to contact with each new transaction servers which are unreachable (out of service), the OMM offers a blacklist feature. If there is no answer from a SIP server, this specific server can be put into a blacklist and will not be contacted anymore for a configurable time of “Blacklist time out” minutes by all adjacent SIP transactions.

In differentiation to the concepts described in the following sections note that independent of which SIP server is used, all requests send by the OMM carry the same sender Address-of-Record (AOR)<sup>1</sup>. This means that the sender URI consisting of user-ID and domain is not changed during a failover to another server.

<sup>1</sup> RFC 3261: An address-of-record (AOR) is a SIP or SIPS URI that points to a domain with a location service that can map the URI to another URI where the user might be available. Typically, the location service is populated through registrations. An AOR is frequently thought of as the “public address” of the user.

### 7.20.3 BACKUP SIP SERVERS

The SIP-DECT solution allows configuration of two additional levels of backup servers, in addition to the primary proxy, outbound proxy and registrar server. These two additional levels of backup servers are referred to as secondary and tertiary servers in the following sections.

Configuration	Intercom/Push-to-talk	Supplementary services	Conference	Security	Certificate server
	Basic settings	Advanced settings	Registration traffic shaping	Backup settings	RTP settings
System	Secondary proxy server	<input type="text" value="10.35.124.69"/>			
Basic settings	Secondary proxy port	<input type="text" value="5060"/>			
Advanced settings	Secondary registrar server	<input type="text" value="10.35.124.69"/>			
SIP	Secondary registrar port	<input type="text" value="5060"/>			
Provisioning	Secondary outbound proxy server	<input type="text"/>			
User administration	Secondary outbound proxy port	<input type="text" value="5060"/>			
Data management	Tertiary proxy server	<input type="text"/>			
Sites	Tertiary proxy port	<input type="text" value="5060"/>			
DECT base stations	Tertiary registrar server	<input type="text"/>			
WLAN	Tertiary registrar port	<input type="text" value="5060"/>			
Video devices	Tertiary outbound proxy server	<input type="text"/>			
DECT phones	Tertiary outbound proxy port	<input type="text" value="5060"/>			
Conference rooms	Failover keep alive	<input type="checkbox"/>			
System features	Failover keep alive time	<input type="text" value="5"/> min			
Licenses					

SIP backup servers can be configured in the **System** -> **SIP** menu of the OM Management Portal (OMP), see also section 6.5.4.

You can configure IP addresses, names or full qualified domain names as server addresses. It is also possible to configure a mixture of IP addresses, names or full qualified domain names for the different servers.

If fully qualified domain names are configured and the respective port setting is configured to zero ("0"), DNS SRV queries are performed to locate a list of servers in the domain. It is assumed that all server addresses are specified by name or IP address. With fully qualified domain names, the behavior described in section 7.20.2 is performed in addition to contact the SIP servers in the given domain.

This redundancy mechanism is based on a failover concept where the OMM first tries to contact the primary server. If the primary server fails, the OMM tries to contact the secondary server and if the secondary server fails also, the OMM tries to contact the tertiary server.

The OMM failover behavior in detail depends on the backup server settings.

#### 7.20.3.1 No Secondary/Tertiary Proxy, Outbound Proxy and Registrar Configured

In this case is no failover to a secondary/tertiary (outbound) proxy / registrar is possible.

#### 7.20.3.2 Secondary/Tertiary Proxy and Registrar Configured

All REGISTER and re-REGISTER requests attempt to use the primary registrar first.

If the primary registrar fails (e.g. no answer in “transaction timer” time frame), the user is tried to register with the secondary/tertiary registrar using as AOR the secondary/tertiary proxy address.

When the registration with the secondary/tertiary registrar succeeds:

- the MWI subscription is moved to the secondary/tertiary proxy,
- all subsequent INVITE requests attempt to use the secondary/tertiary proxy,
- the registration of all other users currently registered with the failed server will be automatically refreshed if the “Failover keep alive” setting is enabled (see page 145). For this purpose, the re-register requests will be queued and proceed according to the settings for “Registration traffic shaping” (see section 5.4.3.5).

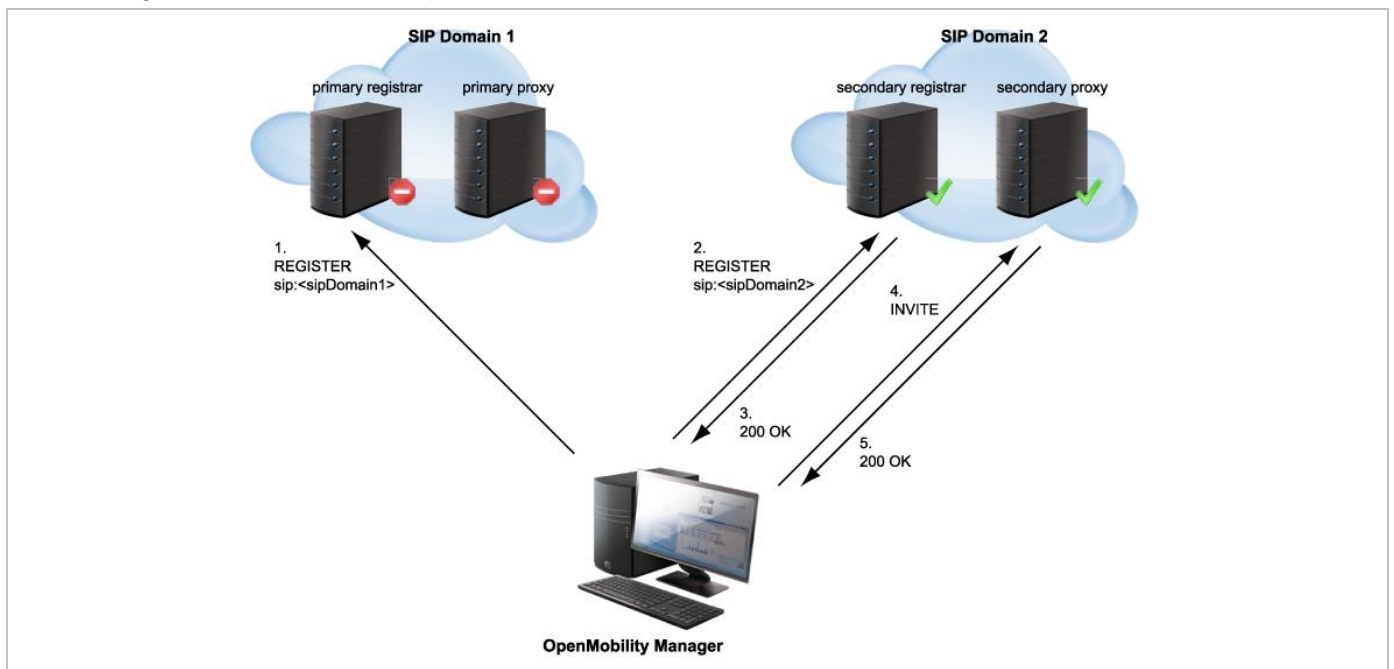

If a user was registered successfully with the secondary/tertiary registrar and can be registered again with the primary registrar e.g. during a re-registration:

- the MWI subscription is moved back to the primary (outbound) proxy,
- all subsequent INVITE requests attempt to use the primary (outbound) proxy again,
- the registration of all other users currently registered with the secondary/tertiary registrar will be automatically refreshed.

As long as no successful registration exists, all INVITE requests attempt to use the primary (outbound) proxy as first.

If the INVITE request to the primary proxy fails, the INVITE request attempts to use the secondary/tertiary proxy. If an INVITE request fails (no answer in “transaction timer” time frame) send to a proxy identical with own registrar, the registration will be refreshed.

### 7.20.3.3 Secondary/Tertiary Proxy, Registrar and Outbound Proxy Configured

In this case, the OMM behavior is as described in section 7.20.3.2 but all requests for the secondary/tertiary proxy/registrar are sent through the outbound proxy.

#### 7.20.3.4 Secondary/Tertiary Proxy Configured Only

All REGISTER, INVITE and SUBSCRIBE requests attempt to use the primary proxy or registrar first. If an INVITE/SUBSCRIBE request fails, the INVITE/SUBSCRIBE request attempts to use the secondary/tertiary proxy.

#### 7.20.3.5 Secondary/Tertiary Outbound Proxy Configured Only

The OMM behavior is as described in section 7.20.3.2 but

- all requests for the secondary/tertiary proxy/registrar are send through the outbound proxy;
- if the registration with the primary registrar fails, the registration is re-tried using the primary proxy address as AOR sent through the outbound proxy.
- 

#### 7.20.3.6 Secondary/Tertiary Registrar Configured Only

All REGISTER, INVITE and SUBSCRIBE requests attempt to use the primary proxy or registrar first. If a REGISTER request fails, the request attempts to use the secondary/tertiary registrar.

### 7.20.4 KEEP ALIVE MECHANISM

A keep-alive mechanism implemented in the OMM allows the automatic failover to secondary/tertiary servers or automatic coming back to primary servers. The keep-alive mechanism is based on the registration process and utilizes the special behavior that all REGISTER and re-REGISTER requests are sent to the primary registrar first.

The following configuration parameters are introduced: **Failover keep alive** and **Failover keep alive time**. These parameters are set in the OM Management Portal (OMP) on the **Backup settings** tab of the **System: SIP** menu (see page 145).

For each registration target, a user could be registered successful with, a keep alive procedure is started. For this purpose the first user registered successful on a registration target will be selected to re-register all “Failover keep alive time” before the registration period expires.

If the re-registration of this selected user detects that the current primary server fails, the registration of all users registered on the same server will be refreshed automatically. For this purpose the re-register requests are queued and proceed according to the registration traffic settings (see section 5.4.3.5 for OMM Web or section 6.5.4.3 for OMP).

If the re-registration of a selected user detects that the primary server is available again, the registration of all users registered on a secondary/tertiary registrar will be refreshed.

### 7.20.5 PRIORITIZED REGISTRATION

Depending on the settings for “Registration traffic shaping”, the registration of a high number of users could need minutes. In effect single users could not be reachable for minutes during startup.

To guarantee a minimum blackout for very important people (e.g. emergency user) the registration of such people can be prioritized. Therefore a special user attribute VIP (very important person) is introduced. The corresponding option is set in the **SIP** tab of the DECT phone **Detail** Panel (see page 190).

### 7.20.6 MONITORING THE SIP REGISTRATION STATUS

The SIP registration status of a DECT phone user can be monitored by using the OpenMobility Management Portal (OMP). In OMP monitor mode you can view on which registrar a specific DECT phone user is registered and whether the server is a primary, secondary or tertiary server. To monitor the SIP registration status proceed as follows:

- 1 Launch the OMP (see section 6.1) and navigate to the **DECT Phones -> Overview** menu.
- 2 Switch to **Monitor Mode**.
- 3 Activate the **Registered**, **Registrar server type**, **Registrar server** and **Registrar port** columns (see section 6.10.9).

### 7.20.7 CONFIGURABLE USER ACCOUNT FOR STANDBY CHECK

The “Standby OMM” feature of SIP-DECT allows configuration of the user account to be used to check iPBX availability. Such an availability check starts automatically in fail over situations.

Therefore, the OMM starts a SIP registration for a specific DECT phone user and sends an OPTIONS request to the configured SIP proxy. If there is an answer, the SIP proxy/registrar is considered reachable and the standby OMM becomes active.

With older SIP-DECT releases, the OMM used the user account with the lowest phone number for the check procedure.

To select a specific user account for this purpose, enable the **Used for visibility checks** flag on the **SIP** tab when creating or editing a DECT phone.

**Please note:** The “Used for visibility checks” flag can only be set for one user. The number for visibility checks is shown in the OMP under **Status -> Users -> Number**. If the flag is not set for a specific user, the OMM uses the user account with the lowest phone number.

### 7.20.8 OMM STANDBY ENHANCEMENT

With SIP-DECT systems using the OMM standby feature it could happen in rare cases that both OMMs become temporarily active. In such a situation all SIP-DECT users were SIP registered from both OMMs to the configured PBX. This can cause problems, when the PBX accepts only one registration per user (non-forking proxy).

To prevent such problems a mechanism is realized to detect situations with two active OMMs. When such a situation is detected the remaining active OMM will SIP re-register all users to the PBX.

This mechanism can be enabled/disabled via the OMP **SIP->Supplementary Services** tab (see section 6.5.4.8).

Basic settings	Advanced settings	Registration traffic shaping	Backup settings	RTP settings	DTMF settings
Intercom/Push-to-talk	Supplementary services	Conference	Security	Certificate server	
Call forwarding / diversion	<input checked="" type="checkbox"/>				
Local line handling	<input checked="" type="checkbox"/>	<i>i</i> When switched off, all R key events (Hook flash) in a call active state will be sent via SIP INFO as DTMF.			
Call transfer by hook (A142d)	<input type="checkbox"/>				
Call transfer by hook (6xxd)	<input checked="" type="checkbox"/>				
Truncate Caller identification after ";"	<input type="checkbox"/>				
SIP reRegister after 2 active OMM failover	<input type="checkbox"/>				
Ringback on hold	<input checked="" type="checkbox"/>				
Call release timeout	<input type="text" value="5"/> sec				
Hold call release timeout	<input type="text" value="5"/> sec				
Failed call release timeout	<input type="text" value="5"/> sec				
		OK	Cancel		

## 7.21 CONFERENCING

Depending on the type of conference server used, SIP-DECT offers the following operational modes:

- **None:** neither external nor internal conference server is used.
- **Integrated:** the conference server integrated in SIP-DECT is used.
- **External:** an external conference server is used, e.g. Broadsoft or Sylanro.
- **External – Blind Transfer:** a MiVoice Business conference server is used, whose proprietary SIP signaling requires that the initiation of the conference be signaled to the destination (as specified in the URL parameter) as a blind transfer.

The conference mode can be configured globally for all SIP-DECT users on the OMP **System** -> **SIP** -> **Conference** tab (see section 6.5.4.9). Alternatively, the conference mode for individual users can be configured on the OMP **DECT Phones** -> **Users** -> **Conference** tab (see section 0). When the **Global** setting is selected for a user, the global system conference mode will be used for this user.



The screenshot shows a configuration window titled "Device #0x002 - User #0x002". It has a tabbed interface with the following tabs: Locating, Additional services, User monitoring, and Configuration data. Under "Configuration data", there are sub-tabs: General, SIP, Incoming calls, Conference (selected), DECT, and Messaging. In the "Conference" tab, the "Server type" is set to "Integrated" with a dropdown arrow. Below it is an empty "URL" text input field. At the bottom, there are "OK" and "Cancel" buttons.

The default for the global system conference mode is **None**. For the user-specific mode, the default is **Global**.

The global and/or user specific conference mode can also be configured via OMM configuration files or the OMM application XML interface (AXI).

### 7.21.1 CENTRALIZED CONFERENCING

To enable SIP centralized conferencing on DECT phones select **External** as **Server type** for all users on the OMP's **System -> SIP** page or for specific users on the OMP's **DECT Phones -> Users** page. If there is specified a proxy / registrar server, then to reach the conference media server via the proxy server, set the **URI** field to one of the following prefixes:

- **conf** (Sylantro server)
- **Conference** (Broadsoft server)

#### Examples

To set the **URI** field to "conf" or "Conference", specify "conf@<proxy-server-address>:<proxy-port>" or "Conference@<proxy-server-address>:<proxy-port>".

To reach the conference media server using a different address/port then that is specified by the proxy, set the **URI** field to "conf@<media-server-address>:<media-port>"

### 7.21.2 INTEGRATED CONFERENCE SERVER (ICS)

The conference server integrated in SIP-DECT is based on the SIP standard RFC 4579 and allows SIP-DECT users the ad-hoc initiation of 3-way conferences.

If this feature is enabled, it allows SIP-DECT users having an active call and holding another call to select **3 party** in the **Options** menu of a Mitel 600 DECT phone to initiate an ad-hoc 3-way conference. If a 3-way conference is initiated, the conference initiator and both connected parties are transferred to the next free conference room hosted on one of the RFP 35 / 36 / 37 / 43 devices.

ICS provides the full range of voice codecs (G722, G711  $\mu$ -law, G711 a-law and G729) and supports trans-coding for all parties in a three-way conference session.

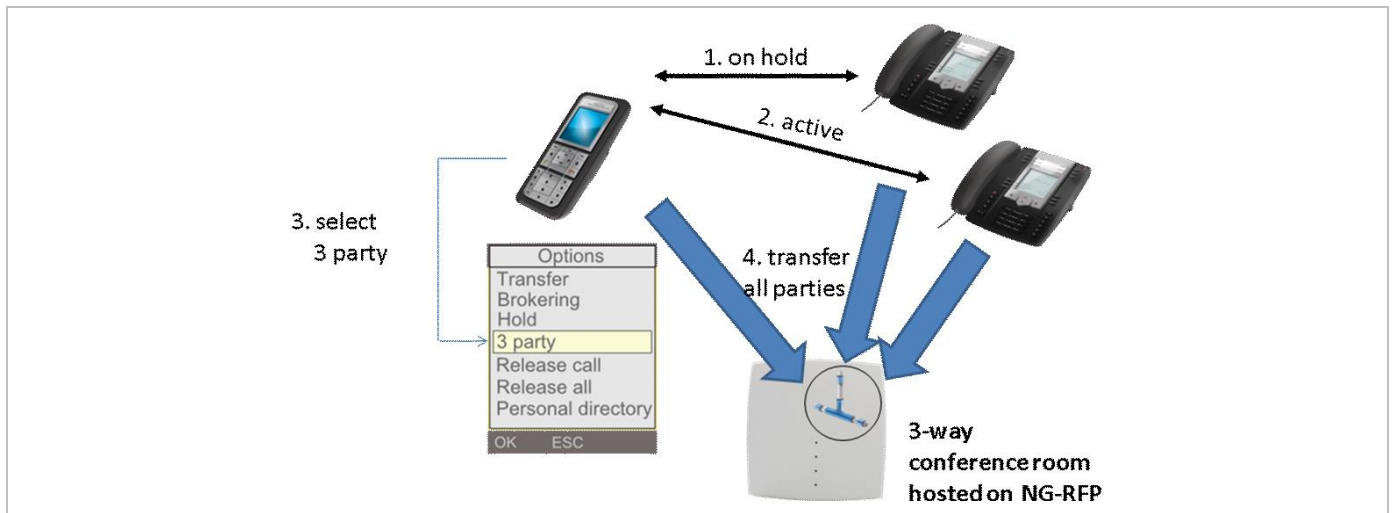

Enabling the SIP-DECT integrated 3-way conferencing requires the following configuration steps:

- Enable internal conference mode
- Select RFP devices for conferencing
- Configure conference rooms

### 7.21.2.1 Enable internal conference mode

To enable SIP-DECT internal 3-way conferencing for DECT phones select **Integrated** as the **Server type** setting for all users on the OMP's **System-> SIP** page or for specific users on the OMP's **DECT Phones -> Users** page.

### 7.21.2.2 Select RFP devices for conferencing

Select some of the RFP devices from your SIP-DECT infrastructure to provide conferences. For this enable the **Conference channels** flag for each selected RFP on the OMP's **DECT base stations -> Devices -> General** tab (see section 0).

**Please note:** Only RFP 35 / 36 / 37 / 43 devices support 3-way conferences.

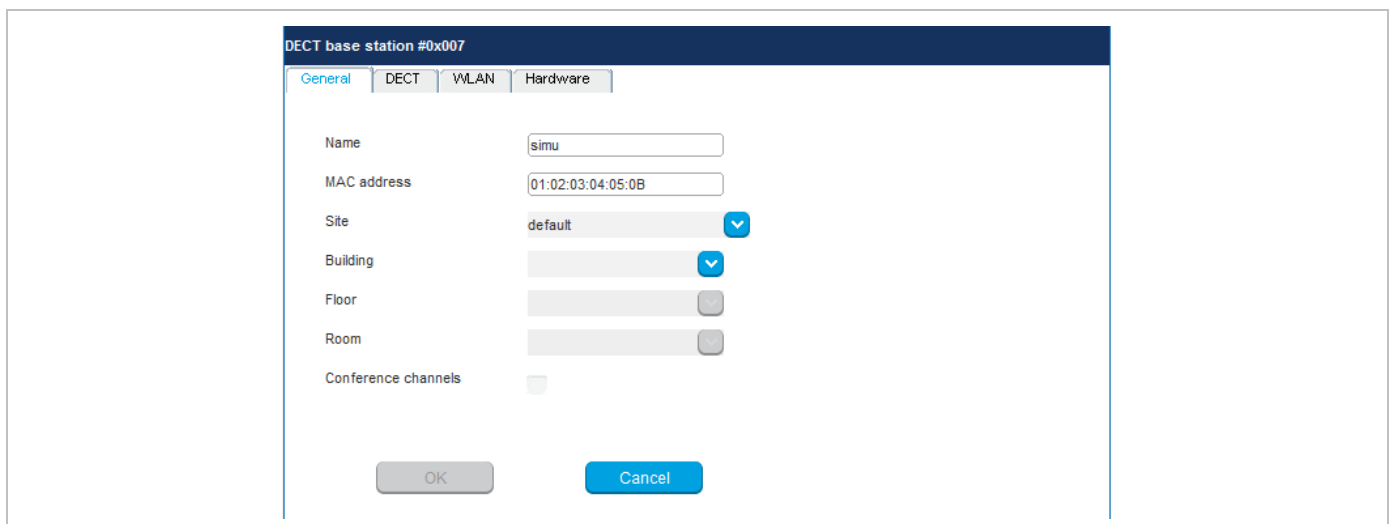

Depending on the DECT and G.729 configuration, an RFP device enabled for conferencing provides between 3 and 24 conference channels. To compute one 3-way conference 3 conference channels are necessary.

In particular, the G.729 codec, with its high consumption of computing time, reduces the number of available conference channels according to the following table.

DECT enabled	Conferencing enabled	G.729 enabled	Conference channels	DECT voice channels
Yes	No	Yes/No	0	8
Yes	Yes	No	15	8
Yes	Yes	Yes	3	5
No	Yes	No	24	0
No	Yes	Yes	9	0

**Please note:** Activating the **Conference channels** option on an RFP with enabled DECT and in a system with enabled G.729 reduces the available DECT channels on that RFP from 8 to 5.

If the G.729 codec is not necessary on your iPBX platform, disable the G.729 codecs on the OMP's the **System: SIP** page / **RTP settings** tab to obtain the maximum number of conference channels.

The total number of conference channels in the SIP-DECT system is presented the OMP's **Status -> Conference** tab. The **Total** parameter provides the total number of conference channels in the system and the **Available** parameter provides the current number of available conference channels.

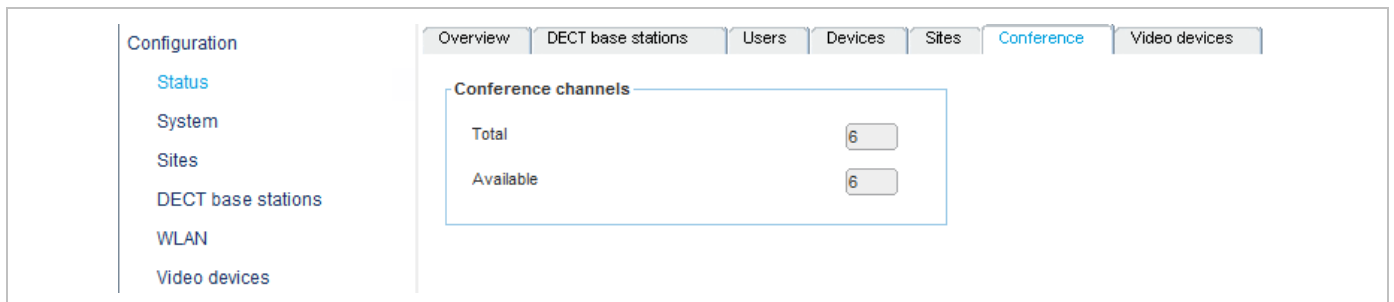

### 7.21.3 CONFIGURE CONFERENCE ROOMS

When a three-way conference is initiated by a SIP-DECT user, the initiator and the connected parties will be transferred to the next free conference room using SIP signalling. These conference rooms must be configured on the OMP's **Conference rooms** page with their SIP user id and SIP password (see section 6.11).

Configure as many conference rooms as necessary and as conference channels are available (3 channels per conference).

These conference rooms will be SIP registered on the configured SIP registrar and must be reachable via the configured SIP proxy for SIP signalling.

ID	Name	Conference ID	Fixed SIP port	Calculated SIP port
0	conf room 25057	25057	0	4060

**Conference room #0**

General

Name: conf room 25057

Conference ID: 25057

User name: 25057

Password: \*\*\*\*\*

Password confirmation: \*\*\*\*\*

Fixed SIP port: 0      Calculated SIP port: 4060

OK      Cancel

The following parameters can be configured for each conference room

- **Name:** SIP display name
- **Conference ID:** SIP user id
- **User Name:** SIP authentication name
- **Password:** SIP password
- **Fixed SIP port:** port used explicitly for SIP signaling. If set to 0 (default), an automatically calculated port is used for this conference room. See section 3.17 for more information.
- **Calculated port:** auto-calculated port used for SIP signaling (read-only). Only used if no value is specified for **Fixed SIP port**.

All configured conference rooms will be registered on the registrar / iPBX configured in OMM. If the **X-Aastra-Id Info** option is enabled on the OMP's **System: SIP -> Advanced settings** tab, a private X-Aastra-Id header is sent out which identifies that these are conference rooms.

The X-Aastra-Id header has the following format for all conference rooms:

X-Aastra-Id: type="29" model="01" version="1.0.0"

The header's attributes have the following properties:

**type**

- the type parameter contains the phone type
- the value for all SIP-DECT conference rooms is "29"
- type = DQUOTE (1\*2HEXDIG) DQUOTE

**model**

- it's the model of the terminal
- the value for all SIP-DECT conference rooms is "01"
- model = DQUOTE (1\*2HEXDIG) DQUOTE

**version**

- the version is intended for later releases
- the value for all SIP-DECT conference rooms is "1.0.0"
- version = DQUOTE (1\*16token) DQUOTE

## 7.22 DOWNLOAD OVER AIR

The “Download Over Air” feature allows updating the DECT phone firmware without any user interaction or interruption of the telephony services over the existing DECT air interface. This feature is currently available for the Mitel 600 DECT Phones.

With SIP-DECT 6.0 and later, the SIP-DECT RFP software image (iprfp3G.dnld) contains the Mitel 600 DECT phone software. If the RFP houses the OMM, the OMM uses this software to update the DECT phones. The RFP OMM no longer automatically attempts to load a DECT phone software image from a RFP software URL when provided via DHCP or local configuration.

For specific maintenance purposes only, SIP-DECT allows configuration of a URL via the OMM Web service or OMP to use an alternative DECT phone software image (see section 5.4.1.6). The Mitel 600 DECT phone firmware packages are delivered in the “600.dnld” file for the OMM running on an RFP.

### 7.22.1 HOW “DOWNLOAD OVER AIR” WORKS

If the “Download over Air” feature is activated (see section 5.4.1.6), the OMM acts as a download server that provides the firmware for downloads.

The DECT phone sends its firmware version within the DECT attachment procedure. If the firmware version does not match the version provided by the OMM, the DECT phone will be queued into the update-queue. Later on the queued DECT phones will be paged to establish a download connection. After the connection is established, the OMM sends its actual DECT phone firmware version and the DECT phone will request a DECT phone description file. After receiving the DECT phone description file, the DECT phone decides which files are missing or must be updated. If files are missing or must be updated the DECT phone initiates the download procedure.

The OMM takes care of the following download scenarios automatically:

- If a DECT phone becomes unreachable e.g. when the DECT phone is switched off, the OMM will update the DECT phone when the DECT phone becomes available again.
- The OMM will take care of the software download while the user is moving between base stations (roaming) and location areas.
- The OMM has the capability of resuming a download from the point where it was last interrupted (e.g., the user leaves the coverage area during download or the DECT phone runs out of battery power).
- The OMM updates new DECT phones subscribed to the system.
- While the DECT phone is barred (e.g. low battery or “Download over Air” is disabled at the local menu), the download will be postponed.

The download happens without any user intervention. During the download, the telephony services, the roaming- and handover procedures are still available. The download stops automatically when e. g. the DECT phone leaves the coverage area or the RFP gets busy. The download resumes automatically when the stop cause is solved.

The Mitel 600 DECT phones have two partitions in the internal flash memory to hold 2 different software versions. During the download the new firmware is written to one partition and the DECT phone is running from the other partition.

After the download is successfully completed, the new firmware will be activated when the DECT phone is in the idle state.

The download of a single DECT phone with a firmware of 1 MB takes approximately 90 minutes. The number of DECT phones which can be downloaded depends on the available system resources.

The number of simultaneous downloads is limited per OMM (RFP: 30, PC: unlimited) and per RFP (6, decreased with each call).

The “Download over Air” service is delayed after a system startup for a while to allow the whole DECT system to become active. This may last several minutes.

### 7.22.2 HOW TO CONFIGURE “DOWNLOAD OVER AIR”

This section describes configuration of the “Download Over Air” feature via the OM Web service. The feature can also be configured using the OM Management Portal (OMP).

The “Download over Air” feature can be activated or deactivated on the **System Settings** web page (see section 5.4.1.6).

In the OMP, you can enable the “Download over Air” feature in the **System -> Advanced settings -> PP firmware** tab (see section 6.5.2.3).

If the “Download over Air feature” is activated, the status of the **Activate firmware update** parameter is shown as enabled, service together with some statistics is displayed in the **DECT phones** section of the **Status** web page.

DECT Phones	
Total number	84
Subscribed	4 <input type="text"/>
Subscription allowed	
Activate firmware update	
Loading firmware from	ftp://10.37.18.35/600.dnld
Firmware version	[600: 5.00.SP5.RC1] - [650,602: 6.0.RC8]
Number of known downloadable DECT phones	4
Number of already updated DECT phones	4

The DECT phone firmware container for DECT phone firmware update over the air includes packages for the Mitel 600 DECT phones. The available versions are also displayed on the **Status** web page.

**Please note:** The “Loading firmware from” on the OpenMobility Manager **Status** web page is only updated on restart of the OpenMobility Manager. Changing the location while the OpenMobility Manager is running has no effect.

The individual download status of each DECT phone is shown on the **DECT Phones** web page.

Auto-create on subscription: ✔

Status

System

Sites

Base Stations

DECT Phones

WLAN

System Features

Licenses

Info

Subscription with configured IPEIs

Wildcard subscription

2 min

1 - 84 (84) DECT Phones

Display name	Number/SIP user name	IPEI	Subscribed	Download
x25052 612d	25052	10345 0031639 *	✔	✔
x25053 622d	25053	03586 0952116 0	✔	✔
x25054 622d	25054	03586 0950946 7	✔	✔
x42052 622d	42052	03586 0952129 3	✔	✔
simu pp 0	256001	00100 0000000 3	✘	-
simu pp 1	256002	00100 0000001 4	✘	-
simu pp 2	256003	00100 0000002 5	✘	-
simu pp 3	256004	00100 0000003 6	✘	-
simu pp 4	256005	00100 0000004 7	✘	-
simu pp 5	256006	00100 0000005 8	✘	-

The details in the **Download** column have the following meaning:

Icon	Meaning
-	Impossible to download the firmware to that DECT phone (e.g. not a Mitel 600 DECT phone)
	The DECT phone is paged to establish a download connection. In case of a successful connection establishment the DECT phone calculates the number of bytes to download. This may take several seconds.
xx kbytes left	The download is ongoing and xx kbytes are left.
	The firmware of this DECT phone is up to date.
	The DECT phone is queued in the update-queue for updating (pending).
	<p>Warning</p> <p>The download is barred because of one of the following reasons:</p> <ul style="list-style-type: none"> <li>– The DECT phone is busy (temporary status).</li> <li>– The battery power is lower than 50% and the DECT phone is not connected to the docking station or the USB interface.</li> <li>– This is not the master download system. A DECT phone can be enrolled on several OpenMobility systems. The first system to which the DECT phone will be enrolled is the “master system”. The DECT phone downloads only from the “master system”. A different “master system” can be chosen inside the local menu of the DECT phone.</li> <li>– The download is disabled in the local menu of the DECT phone.</li> </ul> <p>The specific reason is shown as a tooltip.</p>
	<p>Error</p> <p>The download failed because of one of the following reasons:</p> <ul style="list-style-type: none"> <li>– checksum error,</li> <li>– file system error,</li> <li>– error while writing firmware to flash,</li> <li>– version mismatch,</li> <li>– error while expanding firmware container.</li> </ul> <p>The specific reason is shown as a tooltip.</p>



Icon	Meaning
	<p>Info</p> <p>The download is not possible because:</p> <ul style="list-style-type: none"> <li>– the DECT phone is not reachable</li> <li>– the DECT phone is detached</li> </ul> <p>The specific reason is shown as a tooltip.</p>

In the OMP, the “Download over Air” service status is displayed in the **Status** menu (see section 6.4).

## 7.23 CENTRAL DECT PHONE CONFIGURATION OVER AIR (COA)

Centralized DECT phone configuration over the air is supported for Mitel 602 DECT phones. Configurable parameters include:

- settings (loudness, contrast, etc)
- menu items (switch on or off, enable password protection)
- key assignments (including an override of manual key programming)
- variable lists

DECT phone configuration over air (CoA) is useful for deployment of special configuration to a single DECT phone or a large number of DECT phones. No local access to the DECT phone is required.

DECT phone CoA is implemented by providing additional configuration information to the well-known configuration files or providing profiles via OMP. Configuration can be changed at the device level (DECT subscription) or the user level (based on login).

Configuration of all DECT phones with a predefined default profile is also supported. Up to 20 DECT phone profiles make it easy to adapt to different usage scenarios for heterogeneous user groups (e.g., nurses and doctors in hospital environments).

**IMPORTANT :** This feature requires 6.00 DECT phone software or later.

**IMPORTANT :** Centralized DECT phone configuration over the air is only available on the Download over Air (DoA) master system.

### 7.23.1 CONFIGURATION FILES

You can use three kinds of configuration files:

- Default DECT phone configuration profile  
Default configuration file used for all suitable DECT phones. The configuration is loaded into the DECT phone when subscription is complete, even if a user has not logged in to the device.
- DECT phone configuration profiles  
User-focused DECT phone configuration file used for a group of users. The configuration is loaded into the DECT phone when a user belonging to this group logs in to the device.

- DECT phone user individual configuration settings

Individual DECT phone configuration settings used for a single user. The configuration is loaded into the DECT phone when the user logs in to the device.

The system consolidates the DECT phone settings before loading the configuration settings for a logged-in user into the DECT phone. Settings from DECT phone profiles overwrite default configuration settings, and individual user configuration settings overwrite DECT phone profiles and default configuration settings. For a complete list of supported settings, see section 10.4.

Configuration can be completed by using OMP (file import and download configuration settings) and user configuration files (user\_common.cfg and <user.cfg files), wherein a list of user friendly settings can be used for the DECT phone configuration.

**Please note:** Deleting or overwriting configuration files on a DECT phone does not restore configuration to default or previous settings. Configuration elements that are not part of the new downloaded configuration file persist. To restore all settings, the administrator must initiate a power off/on at the DECT phone or use a default configuration file that contains all relevant settings.

To avoid interfering with the telephony or message service (especially with respect to alarm messages within the SIP-DECT system), only one configuration data download to the DECT phone is performed at a time. Therefore, changing the default profile settings or other profile settings may take some time in a large system, until all the related DECT phones are updated.

### 7.23.2 CONFIGURATION FILE DOWNLOAD TO DECT PHONES

Profiles are downloaded to the DECT phone via the messaging mechanism, in conjunction with the internal message type “CONF\_OVER\_AIR”. This occurs in parallel with general message transfer to the DECT phone, and the lowest priority is used to ensure that the download does not interfere with the delivery of urgent messages. The message mechanism is also used to confirm a successful profile download, through AXI events.

Profile downloads to DECT phones are limited system-wide to a maximum of one download at a time to ensure no interference with OMM system operation. You can view the download on the OMM console (console command `hcm`). The download state is also part of the system dump.

#### 7.23.2.1 Download Triggers

The OMM maintains a profile download list for all DECT phones that have configuration data to be set. These DECT phones are stored with the checksum of configuration data to be set. A DECT phone is included in this list when:

- the OMM system starts up and the associated DECT phone has configuration data to be set
- the associated DECT phone’s configuration data changes (this is communicated via AXI), such as:
  - change in the default configuration profile
  - change in the configuration profile for the user of the associated DECT phone
  - change in the individual user configuration profile for the user using the associated DECT phone
  - change in the configuration profile assigned to the user using the associated DECT phone

Profile downloads to the DECT phones (as maintained in the profile download list) are scheduled at regular intervals. A new download to DECT phones in the profile download list is scheduled when:

- a configuration change occurs on the DECT phone (via AXI notification)

- a location registration is received, and the checksum of the configuration data stored in the profile download list is different from the checksum sent in the location registration
- a download to a DECT phone completes

### 7.23.3 COA CONFIGURATION USING OMP

OMP configuration of DECT phones is restricted. You can do the following through OMP:

- list the current user and device state via the **DECT Phones -> Overview** menu and **DECT Phones -> Devices -> Configuration data** tab (in Monitoring mode)
- import the default profile and one to 20 individual profiles via the **System features -> COA profiles** menu (see section 6.12.8)
- assign one of 20 profiles to an internal user via the **DECT Phones -> Users -> Configuration data** tab (see section 6.10.4.10)

The syntax of the profiles that can be imported by the OMP is the same as that specified for the user\_common.cfg and <user>.cfg files.

**Please note:** CoA configuration via OMM Web service is not supported. You can only list the current user and DECT phone state in the “User and DECT phone configuration and status data summary”.

### 7.23.4 CONFIGURATION USING USR\_COMMON.CFG/<USER>/CFG FILES

The user\_common.cfg and <user>.cfg configuration files are used for DECT phone configuration. The following configuration attributes in the user\_common.cfg file control central DECT phone configuration:

- Default profile settings

```
OM_Profile.0.Default.<key>=<values>
```

...

```
OM_Profile.0.Default.<key>=<values>
```

Where “Default” is the reserved name for the default profile, and <key> is one of the configuration settings with its <values> to be set.

#### Example:

```
OM_Profile.0.Default.UD_DispLang="en"
OM_Profile.0.Default.UD_DispFont="large"
OM_Profile.0.Default.UD_DispColor="black"
```

- one of up to 20 profile settings

```
OM_Profile.<no>.<name>.<key>=<values>
```

...

```
OM_Profile.<no>.<name>.<key>=<values>
```

Where <no> is the number of the profile, <name> is the name of the profile to be configured, and <key> is one of the configuration settings with its <values> to be set.

#### Example:

```
OM_Profile.5.Doctor.UD_Displang="en"
OM_Profile.5. Doctor.UD_DispFont="large"
OM_Profile.5. Doctor .UD_DispColor="black"
```

**Please note:** To assign a profile to a user, you can use the UD\_PpProfileId= <profileNo> setting in <user>.cfg files. When <profileNo> is 0, no profile or (depending on configuration) the default profile is used. The default profile is defined in user\_common.cfg.

**Please note:** A complete removal of a profile from user\_common.cfg does not remove the profile in the OMM database. It must be explicitly deleted in the OMM database.

For individual user DECT phone configuration settings, the following configuration attributes are available in the <user>.cfg file:

- User configuration settings

```
<key>=<values>
...
<key>=<values>
```

Where <key> is one of the configuration settings with its <values> to be set.

**Example:**

```
UD_Displang="en"
UD_DispFont="large"
UD_DispColor="black"
```

**7.23.4.1 CoA Example**

<pre>UD_ConfigurationName = "omm-test" UD_Displang="en" UD_DispFont="small" UD_DispColor="black" UD_RingerMelodyIntern="ringing_1" UD_RingerMelodyExtern="ringing_2" UD_RingerVolumeIntern="increasing" UD_RingerVolumeExtern="increasing"</pre>	<pre>Configuration file is named "omm-test" Language is set to English Display font is set to small Display color scheme is set to black Internal call melody is set to melody "ringing_1" Internal call melody is set to melody "ringing_2" Internal call ringer volume is set to increasing External call ringer volume is set to increasing</pre>
--	--

See section 10.4 for a full list of supported CoA configuration parameters.

**7.23.5 VARIABLE LISTS**

The Mitel 602 DECT phone 6.1 firmware introduces variable lists. A variable list includes a number of items, each of which corresponds to an action to be performed on the DECT phone.

A list item consists of an index identifier (1..10) and either a number (to be dialed) or a function/feature that is supported by the DECT phone. Other attributes are optional. If there is a FunctionID, the entry does not have a sub key line in the variable list. If there is a number and a FunctionID the DECT phone executes the associated action (if available); otherwise, the DECT phone dials the number.

Item Attribute	Type	Description	Example
----------------	------	-------------	---------

Index	Decimal number	Index of list item (1..10)	7
Number	quoted UTF8-string	Number to dial	"\x2312*777*" (use \x23 for # in configuration file)
Name	quoted UTF8-string	Text displayed for item	"My Voice Box"
FunctionID	Function-ID-string	Function or feature to execute	pbx_directory
ShortName/Icon	quoted UTF8-string	Short name and/or icon displayed	"\xEE808B VB"
Handsfree	Boolean ("0" or "1")	Dial in hands-free mode	1
VisibleSpecifier	4 digit string of "0" or "1"	Item visible in idle, dial, alerting and active state	1000

The CoA profile supports two variable lists for each DECT phone. Each list can contain up to 10 items. Use the `UD_VListEntry` configuration command to configure an item for one of the lists. The first value specifies the index (1 or 2) of the list, followed by the attributes listed above.

The values-attribute pairs must be separated by a space and their position in the configuration command are fixed. Unused attributes must be indicated by empty strings if they are followed by non-empty attributes. Unused attributes (empty strings) can be omitted at the end of the configuration command.

A variable list can hold a name and/or short name (used to represent it in another list or near a programmed soft key or side key). The 'short name' attribute also allows you to specify an icon. A third attribute, 'sub item', determines whether or not subitems (sub key lines) of a list are displayed. By default, the subitem (sub key line) is only displayed if the item is selected.

List Attribute	Type	Description	Example
Name	quoted UTF8-string	Text displayed for list	"My Own Menu"
ShortName/Icon	quoted UTF8-string	Short name and/or icon displayed	"\xEE808B M1"
SubItems	Boolean (0 or 1)	Show sub-key line of selected item	1

**Examples:**

```
#PBX Menu using COA variable list
UD_ConfigurationName=PBX Menu

#Key assignment (function: vlst1 and vlst2)
UD_KeyAssignmentIdle=esc vlst1

#Menu Design
UD_VListName = 1 "Call services" #Titel
UD_VListShortName = 1 "More" #Softkey
UD_VListSubItems = 1 0 #Display Details per Item

### PLACEHOLDERS to add into Number field:
#<no> will be replaced with a number from handset editor e.g. "*12*<no>#"
#<dial> will be replaced with a number from handset editor or directory, caller-list...
```

```
#<t=...> following dial-digits will be delayed for ... ms e.g. <t=3000ms>
#<inf=...> set info-box with ... string for (3000ms) continue dialing after info box e.g.
#<inf=Please wait>
#<r=...> call will be released after ... ms e.g. <r=10000>
#<close> will close this Menu.
```

```
### Entry: UD_VListEntry = List Index "Number" "Name" FunctionID "ShortName" Handsfree
# Visible

































#ITEM          TYPE          DESCRIPTION
#List          decimal number  item belong to variable list (1..2)
#Index        decimal number  index of list item (1..10)
#Number       quoted UTF8-string  number to dial "*"1234" (use \x23 for #)
#Name        quoted UTF8-string  displayed text of item "My Voice Box"
#FunctionID   function-ID-string  function/feature to execute e.g. pbx_directory
#             (if available, preference over number)
#ShortName   quoted UTF8-string  displayed short name and/or icon
#Handsfree   Boolean (0 or 1)  dial in hands-free-mode
#Visible     4-digit-string of 0 or 1  item visible in idle-, dial-, alerting- and
#             active-state e.g.1000
#notice: to skip a parameter in the row use "" (even if the type is unquoted)
```













```
### idle menu functions
#Call Forward      **8 (predial) + number
#Call Forward Cancel  ##8 (dial)
#Do Not Disturb    *5 (dial)
#Do Not Dist. Cancel  #5 (dial)
#Call Pickup       *6 (dial)
#Call Park Retrieve *8# (predial) + number
#Direct/Group Page *37 (predial) + number
#Loudspeaker Page  **9 (dial)
```

```
UD_VListEntry = 1 1 "*"8<dial>\x23<inf=Call FWD enabled><r=2000>" "Call Forward" "" "" ""
UD_VListEntry = 1 2 "\x23\x238<inf=CallFWD off><r=1000><close>" "Call Forward Cancel" ""
"" ""
UD_VListEntry = 1 3 "*5<inf=DND enabled><r=1000><close>" "Do Not Disturb" "" ""
UD_VListEntry = 1 4 "\x235<inf=DND off><r=1000><close>" "Do Not Dist. Cancel" "" ""
UD_VListEntry = 1 5 "*6<close>" "Call Pickup" "" "" ""
UD_VListEntry = 1 6 "*"8\x23<dial>" "Call Park Retrieve" "" "" ""
UD_VListEntry = 1 7 "*37<dial>" "Direct/Group Page" "" "" ""
UD_VListEntry = 1 8 "*"9<close>" "Loudspeaker Page" "" "" ""
```

### 7.23.5.1 Icon coding

The following table lists the UTF8-codes for Mitel 602 DECT phone icons.

ICON	UTF8-Code	Description
	\xEE8083	Arrow Up
	\xEE8084	Arrow Down
	\xEE8085	Arrow Left
	\xEE8086	Arrow Right
	\xEE8088	Fox Key
	\xEE80B0	Locked
	\xEE80BC	Search
	\xEE80BE	Info
	\xEE81A5	Attention
	\xEE80BA	Tip
	\xEE808A	Telbook Private number
	\xEE808B	Telbook Mobile number
	\xEE808C	Telbook Business number
	\xEE818C	VIP number
	\xEE808D	Telbook Fax number
	\xEE808E	Telbook Email address
	\xEE808F	Telbook Name
	\xEE809B	Hook off / Predial
	\xEE809C	Hook on / Release
	\xEE81B0	Register recall
	\xEE8092	DTMF
	\xEE8182	3-party
	\xEE80A0	List Incoming call list
	\xEE80A1	List Outgoing call list
	\xEE8196	List Private directory /
	\xEE8199	List Central directory
	\xEE818C	List VIP
	\xEE8181	List Filter / Call Filtered
	\xEE80A1	Call outgoing
	\xEE8099	Call Waiting
	\xEE80A7	Call Rejected
	\xEE81AD	Call SOS
	\xEE809D	Call Headset autoanswer

ICON	UTF8-Code	Description
	\xEE8098	Call Loudspeaker autoanswer
	\xEE809B	Call Hook autoanswer
	\xEE80B8	Call deflected
	\xEE80A3	Call missed
	\xEE80A4	Call answered
	\xEE8195	Call on Voicebox
	\xEE81AE	Call VIP
	\xEE81B1	Pickup
	\xEE81B2	Pickup select
	\xEE8296	Call Park
	\xEE80BF	Call protection
	\xEE8298	Call routing
	\xEE8292	Callback

### 7.23.5.2 Number string coding

Note that the number specified in the list item may include one or more placeholders, so that, for example, the user can enter a number before the number is dialed. The placeholder keywords are specified in angle brackets ("`<>`").

If the dialed number includes angle brackets, you must use "`<< >>`".

Number Placeholder	Description
<code>&lt;no&gt;</code>	If the number strings consists of <code>&lt;no&gt;</code> , it is replaced with a number from the DECT phone editor
<code>&lt;dial&gt;</code>	If the number string consists of <code>&lt;dial&gt;</code> it is replaced with a number from the DECT phone editor or directory, caller-list. For example, <code>"*12*&lt;no&gt;#" -&gt; ok &lt;edit-number&gt; send cc-info"*12*"&lt;edit-number&gt;"#</code> (numbers may include letters like abcd... if the system supports alpha dialing)
<code>&lt;close&gt;</code>	All parents (e.g a list from witch this item is started) are closed
<code>&lt;t=...&gt;</code>	Following dial-digits are delayed for ... ms e.g. <code>&lt;t=3000ms&gt;</code>
<code>&lt;inf=...&gt;</code>	Set info-box with ... string for (3000ms) continue dialing after info box ( e.g. <code>&lt;inf=Please wait&gt;</code> )
<code>&lt;r=...&gt;</code>	Call is released after ... ms e.g. <code>&lt;r=10000&gt;</code>



## 7.24 EXTENDED DECT PHONE INTERFACE

With SIP-DECT 6.0 and later, the Mitel 600 DECT phones include an **Administration** menu that offers administrative functions to the user such as login, logout, and configuration and status summary display. The menu is available as an option under the **System menu** which can be accessed via the main menu of the DECT phone, or directly by a long press of the right soft key “>>>”.

**Please note:** The **Administration** menu is only available on Mitel 600 DECT phones, version 4.0 or higher.

The following table summarizes the options under the **Administration** menu. The menus allow basic OMM configuration and require a login (the same account and password as used for administrative access via OMP or Web service).

	Menu option	Description	OMM login
1.	<b>Login</b>	User can log in to the DECT phone (free DECT phone only)	
2.	<b>Logout</b>	User can log out of the DECT phone (free DECT phone only)	
3.	<b>PP state</b>	Display user/device configuratoin and status data summary (see section 5.7.6 for details)	
4.	<b>Sync user data</b>	Refresh SIP registration and synchronize user data, if they are stored externally	
5.	<b>Sync system data</b>	Reload configuration and resource files	Yes
6.	<b>System credentials</b>	Set authentication for provisioning servers (see section 7.8.6.1)	Conditional
7.	<b>Status</b>	Display basic OMM network settings (e.g., DHCP, IP addresses)	
8.	<b>System</b>	Set basic OMM system data	Yes
9.	<b>SIP users/devices</b>	Perform basic configuration of users and DECT phones	Yes
10.	<b>Version</b>	Display current OMM software version	

The options available depend on the DECT phone state and the OMM platform (i.e., RFP OMM or Linux Server). The following table summarizes the options under the **Administration** menu according to device state and OMM platform.

	Menu option	Fixed device	Logged out	Logged in	RFP OMM	Linux Server OMM
1.	<b>Login</b>		√		√	√
2.	<b>Logout</b>			√	√	√
3.	<b>PP state</b>	√		√	√	√
4.	<b>Sync user data</b>	√		√	√	√
5.	<b>Sync system data</b>	√	√	√	√	√

6.	System credentials	√	√	√	√	√
7.	Status	√	√	√	√	
8.	System	√	√	√	√	√
9.	SIP users/devices	√	√	√	√	√
10.	Version	√	√	√	√	√

The following table summarizes the submenus available according to the OMM platform.

	Submenu	SIP-DECT	RFP OMM	Linux Server OMM
1.	System name	√	√	√
2.	Date and Time	√	√	
3.	SIP	√	√	√
4.	User administration	√	√	√
5.	Restart	√	√	√

## 7.25 OMM/DECT PHONE LOCK WITH BRANDING ID

With SIP-DECT 6.0 and later, customers can use a specific branding key to lock the OMM. The key must be branded to all DECT phones before they can be subscribed.

**Note:** This feature is only available by special request. Please contact your Mitel representative for more information.

You generate the branding key using the `DECTSuiteBrandingInstallation.exe` tool (provided by Mitel on special request). When you have the generated keys, you set the branding key in the OMP, via the **System -> Advanced Settings -> Special branding** tab (see section 6.5.2.7).

The branding key can be only removed from the OMM system by using a special key, also generated with the DECT-Suite PC Tool and entered in the OMP Special branding tab. You must remove the branding key before changing to a different brand.

### 7.25.1 SUBSCRIBING THE DECT PHONE

The user who subscribes the DECT phone must explicitly invoke the transfer of the branding key (done in the AC-Editor).

Add "R\*" (or "R<additional\_id>" in one case) as a suffix to the typed AC code (or just R\*, if there is no AC code).

- Type R\* for normal subscription for fixed devices.
- Type R\* for auto-create by subscription.
- Type R\* for wildcard subscription without DECT phone data record selection.

- Type R<additional\_id> for wildcard subscription with record selection by the additional id.

## 7.26 DEVICE PLACEMENT

The OM Locating application uses small graphic maps for visualization of DECT base station placement. From SIP-DECT release 3.1 on, these graphics can be created with the OMP in **Planning Mode**.

### 7.26.1 “PLACEMENT” VIEW

By using the mouse with drag and drop, you can move RFP icons to their correct mounting position on the loaded background image. Note that you must provide background images first (see also /27/).

A DECT base station is drawn as green circle with its ID number inside.

Background images can be loaded into the application on the **Image Management** panel (see section 7.26.3).

The assignment of devices to the currently active image must be done on the **DECT base stations** page.

#### 7.26.1.1 Functionality of the “Placement” View

- Left mouse click selects/deselects the DECT base station the mouse is pointing to. A selected device is shown with thicker border.
- Drag and drop functionality: a device can be moved while the left mouse button is pressed and hold.
- If left mouse button is hold and no device is selected, the complete view content gets moved.
- By turning the mouse wheel the view gets scaled up or down depending from the direction of turning.
- By pressing the right mouse button a pop-up menu is displayed:
  - **Move selected RFPs:** All selected devices (drawn with a thick border) will be moved to the current position of the mouse pointer. Distances between the devices are not changed as long as all devices can be drawn inside the background image. Moving devices to the area outside the upper or left border of the image is not possible.
  - **Reset selection:** The selection is canceled for all currently selected devices.
  - **Remove selected device(s):** Selected devices are removed from the current image after confirmation in a dialog box. Those devices can be assigned to an image again via the **DECT base stations** menu (see also section 7.26.2).  
If no devices are selected but the mouse is pointing to a device, that device is removed from the image without further inquiry.
  - **Reset view:** The view is redrawn in its original appearance. Any translation and scaling applied to the view is cancelled.

#### 7.26.1.2 Activation of the “Placement View”

The **Placement view** can be activated by:

- Selecting the **Placement view** menu entry. The currently loaded image with its assigned devices is displayed. If no image is currently loaded, the view is empty.
- Double-clicking on a table row in the **DECT base stations** view. This activates the placement view with the image the clicked device is assigned to.

- Selecting the **Assign to active image** task in the **DECT base stations** view. The selected devices are assigned from the table to the current image.  
If a selected device was already assigned to another image, the assignment is changed upon confirmation in a dialog window.
- Selecting an entry in the **Image management** view (double-click or click on **Show image** task).

### 7.26.2 “DECT BASE STATIONS” VIEW

The view shows a table based list of RFP.

When you select table rows and click **Assign to active image**, the selected devices are assigned to the currently active image. Devices already assigned are tagged with a green sign in the table column **Positioned**.

If a selected device was already assigned to another image, the assignment will be changed when confirmed through a confirmation dialog.

### 7.26.3 “IMAGE MANAGEMENT” VIEW

With the **Image management** view all background images assigned to the SIP-DECT system can be managed. Also, the generation of the graphic maps used by the OM Locating application can be started by this view.

If the user activates this view and a background image was loaded, the OMP automatically creates a project file the current SIP-DECT system on the PC. This file contains references to the background image files and the device assignment and placement coordinates. It automatically gets reloaded to the application if the OMP user enters the **Device Placement** menu again during a connection to the same SIP-DECT system.

The images and placement coordinates are stored only on the local PC and not together with the SIP-DECT system configuration (due to storage size limitations). Therefore it is recommended to export the project and save the project data at a secure place after finishing the placement of devices for a SIP-DECT system.

#### 7.26.3.1 “Show image” Task

After selecting an image entry from the table with a left mouse click and then selecting the **Show image** task, the image will be displayed with its assigned devices in the **Placement view**.

A left mouse double click on a table entry also opens the **Placement view**.

#### 7.26.3.2 “Add image” Task

With the **Add image** task, the user calls up a File Open dialog which allows the addition of one or more background images stored on the PC to the system.

The OMP supports \*.jpg and \*.png image files. A maximum of 800 images can be managed by the OMP. The maximum size per image is limited to 3000 pixel in both height and width.

#### 7.26.3.3 “Remove image” Task

The selected image table entries will be removed from the current project after an inquiry dialog. All devices which were already assigned to one of the removed images will be reset to unassigned state.

#### 7.26.3.4 “Generate” Task

By choosing this task the user can start the generation of the graphics data needed by the OM Locating application. The OMP will only create graphics data for selected image table.

In a file save dialog the user can select a storage directory for the generated graphics data. A progress dialog informs about the actual status of the generation process. If the process is canceled by the user, the OMP will finish generation of graphics data for the actual background image before stopping the process.

#### 7.26.3.5 “Import project” Task

With the **Import project** task the user can load a previously exported project. Images and device placements done before importing a project will be substituted by the data contained in the project.

The system name and the PARK are not checked during this operation. It is possible to import a project created for another system or after the system name or PARK was changed.

Devices are managed by their IDs. If a device ID from imported data cannot be matched with a device ID from the system the OMP is currently connected to, the placement data for such a device will not be imported.

The image files will not be copied. The actual project will save references to the storage place of the images.

#### 7.26.3.6 “Export project” Task

With the **Export project** task, the user opens a File Save dialog where the user can select a directory for the exported data, or create a new one.

The OMP exports the project file and copies all background image files to the chosen destination.

A project exported with this task can be imported again via the **Import project** task.

#### 7.26.3.7 “Adjust overview size” Task

The OM Locating application needs two graphic maps for each device:

- One detail map image showing the position of an RFP in same scale as the background image on which the device was placed.
- An overview map showing a bigger area of the background image down scaled and the position of the RFP.

There is no special requirement to the scale of the used background images. The selection of the overview scale may differ depending from building or area proportions.

With the **Adjust overview zoom** task the user can adjust the down scale zoom factor for the overview map images (2) individually for the currently selected background image.

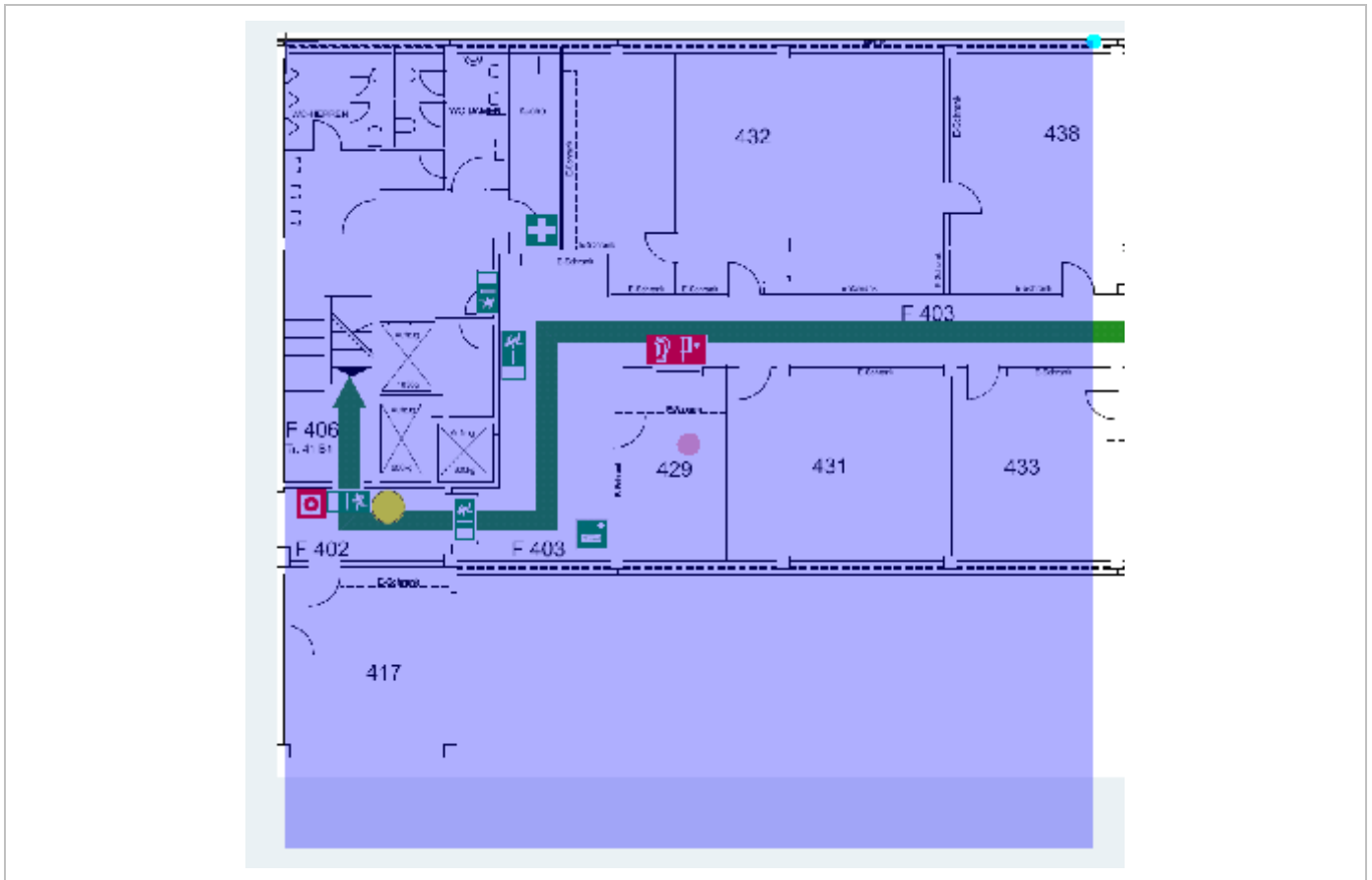

The content of an area generated as overview map is shown by the transparent overlay square. Changing the size of this area can be done by grabbing the light blue point at the right upper edge and moving the edge to (or away from) the center of the area.

By grabbing the red point in the middle of the overlay square it is possible to move the overlay square around.

For generation of the overview map images the position of overlay square does not matter. Only the size is important to calculate the scale ratio for down scaling.

### 7.26.3.8 “Set overview size” Task

Instead of adjusting the scale factor for down scaling on generation of overview maps with the method described in section 7.26.3.7 it is possible to set a scale factor for the selected images.

The value of the scale factor must be chosen with the slider **Overview size** in the task panel prior to assign it to one, several or all images with the **Set overview size** task.

## 7.27 MONITORING WITH USB VIDEO DEVICES

To use an USB video device in interaction with the OM Locating application, a video user account must be configured. In addition the configuration and activation of a video device (“USB Web Cam”) itself is needed.

### 7.27.1 CONFIGURATION OF A VIDEO USER ACCOUNT

An active user account with at least read and video permissions must be configured, to use it inside the OM Locating application.

ID	Comment	User name	Password aging	Active
0	Read-only	user	None	✘
1	Full access	omm	None	✔
2	Root (SSH only)	root	None	✔

User account #1 - Full access	
General	Permissions
Read	<input checked="" type="checkbox"/>
Write	<input checked="" type="checkbox"/>
Messaging info	<input checked="" type="checkbox"/>
Messaging	<input checked="" type="checkbox"/>
Messaging emergency	<input checked="" type="checkbox"/>
Messaging locating	<input checked="" type="checkbox"/>
Locating	<input checked="" type="checkbox"/>
Monitoring	<input checked="" type="checkbox"/>
Video	<input checked="" type="checkbox"/>

**Please note:** If you have already configured the OMM’s “Full access” account within the OM Locating application to access OMM service, you must change this account to the video-enabled account created in this step.

### 7.27.2 CONFIGURATION OF USB VIDEO DEVICES

You configure video devices on the OMP’s **Video devices** page (see section 6.9). The **Video devices** page contains a list of known video devices and you can access the configuration window for the video devices by double-clicking on an entry. Use the left side of the panel to enter a description of the camera and its position. On the right side of the window, you can set the parameters for **Resolution** and **Frame rate**.

The selected values for resolution and frame rate must fit the parameter specifications of the camera device. Changes to these settings are not possible on cameras in a “started” state (i.e., viewed in the OM Location application).

By setting the **Active** option, the video device is permitted to send images.

### 7.27.3 MONITORING WITH USB VIDEO DEVICES

Using the OMP monitoring mode for a video device opens a window with two tabs, the **General** tab and the **Status** tab. On the **General** tab the actual configuration of the video device will be shown. On the **Status** tab the actual status of the camera device will be shown. The tag is an internal identifier of a video device, the **RFP ID** is the identifier of the RFP the video device is plugged in, **USB path** is an identification of the plug-in position and **State** is the actual state of the video device.

## 7.28 TERMINAL VIDEO

As of SIP-DECT 5.0, Mitel 602 DECT phones support video streams from cameras connected to SIP-DECT RFP 35/43 base stations. When a user has video stream permission, he can choose in the system menu from a list of cameras to connect.



Video Streaming is only available when the DECT phone is connected to a RFP 35 and the permission is set for the site and the DECT phone.

Video streams are treated like a call by the DECT phone, which require two (of eight) air channels on the RFP for each stream. The DECT phone can also perform handover between DECT base stations with an active video connection.

A video connection is automatically terminated by the system in case that any related capability (e.g. video stream permission) is changed.

### 7.28.1 TECHNICAL DETAILS

Terminal video resolution and framerate are independent from the configured camera resolution and framerate.

The resolution of the terminal video stream is automatically downscaled to 176 \* 144 pixels (QCIF) with a frame rate of approximately 2 frames per second.

The resulting overall delay is below 2 seconds.

The maximum number of simultaneous terminal video streams per camera is restricted to 10.

### 7.28.2 OMP CONFIGURATION STEPS

Connection and configuration of cameras is similar to the steps required to configure the locating application. Special steps necessary for terminal video are:

- Enable all sites, which have the technical capability (only RFP 35/36/37/43 are referred to it), via OMP for terminal video.
- Enable via OMP (**DECT Phones -> Users -> Additional services**) by setting the "Video stream permission" for those users who are allowed to use this feature.



**Please note:** It is strongly recommended that you set the DECT base station attributes “building”, “floor” and “room”, if you configure a large system with a large number of cameras. This makes selection of cameras on the DECT phone menu easier.

### 7.28.3 CAMERA SELECTION VIA DECT PHONE MENU

The **Cameras** menu is available in the Mitel 602 DECT phone **System menu**, if

- at least one camera is plugged and activated by the enable flag
- the DECT phone user has the permission to select cameras
- the DECT phone is located within a site, which allows terminal video

The user navigates within the camera menu using the **OK** (and **ESC**) keys. When the desired camera is selected in the list, the user can press the “hook off” button to establish a video stream.

If the number of cameras exceeds the lines of the DECT phones display, the presentation is arranged hierarchically. At least one sublevel must be selected in this case before camera names are offered. The hierarchy of the referred DECT base stations (site, building, etc) is inherited for that purpose.

The destination of a video call is added to the DECT phone internal redial list.

**Please note:** During an established video link, audio calls or any system service activities are not possible.

Any kind of auto callback (initiated by a message by a message or pushed by xml notification to direct dial) is not supported.

## 7.29 USER MONITORING

To check the availability of a user in terms of the possibility to receive calls or messages, the OMM monitors the status of the user’s DECT device.

### 7.29.1 OVERVIEW

With the “user monitoring” feature the following fixed set of status information is monitored:

Is a DECT phone assigned to the user?	Handset assignment status (HAS)
Is the DECT phone subscribed to the DECT system?	Handset subscription status (HSS)
Is the DECT phone currently registered /signed in?	Handset registration status (HRS)
Are there DECT phone activities within a specific timeframe?	Handset activity status (HCS)
Is the user registered at the SIP registrar?	SIP user registration status (SRS)
Is the DECT phone not in silent charging mode (silent charging option active and in the charger cradle)?	Silent charging status (SCS)
Is the feature “immediate call diversion” inactive?	Call diversion status (CDS)
Is the battery charge higher than the configured threshold?	Handset battery state (HBS)

Does the DECT phone have the minimum required software version? Software Status (SWS)

If all questions can be answered with “Yes” then the user status is set to “Available”. This set of status information is monitored if user monitoring is enabled for a user.

The status of all monitored users is displayed in the **DECT Phones -> User monitoring** menu (see also section 7.29.7.3). The status information can have one of the following values:

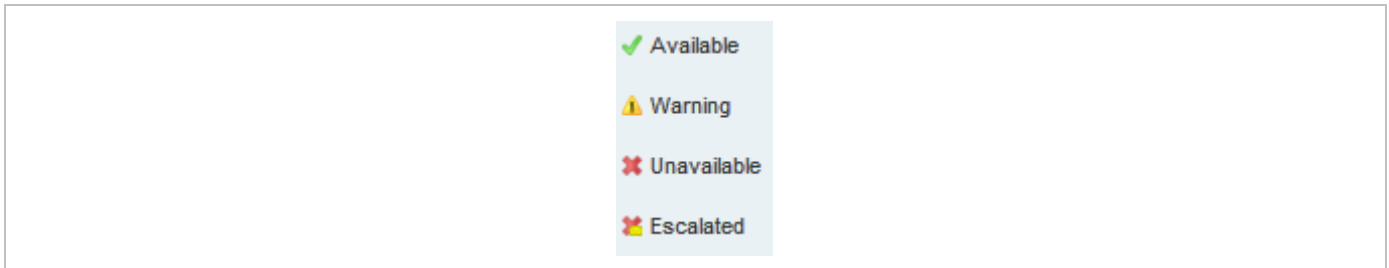

The sum of all specific states is presented by the “Combined User Status”.

User ID	Name	Number	Rel. devi.	Mode	CUS	HAS	HSS	HRS	HCS	SRS	SCS	CDS	HBS	BTS	SWS
0x03D	Georg Wolf	2358	0x056	Passive	✓	✓	✓	✓	✓	✓	✓	✓	✓	✓	✓

If one of the states is set to unavailable, the resulting Combined User Status is set to unavailable as well.

0x00E	Lutz Püschel	2476	0x0E0	Passive	✗	✗						✓			
-------	--------------	------	-------	---------	---	---	--	--	--	--	--	---	--	--	--

Because of dependencies between the states, some states cannot be determined if a higher level state is not fulfilled. For example, if the user has no DECT phone assigned, the DECT phone registration status cannot be determined. If a status cannot be determined, the status value is set to “Unknown” (empty in OMP).



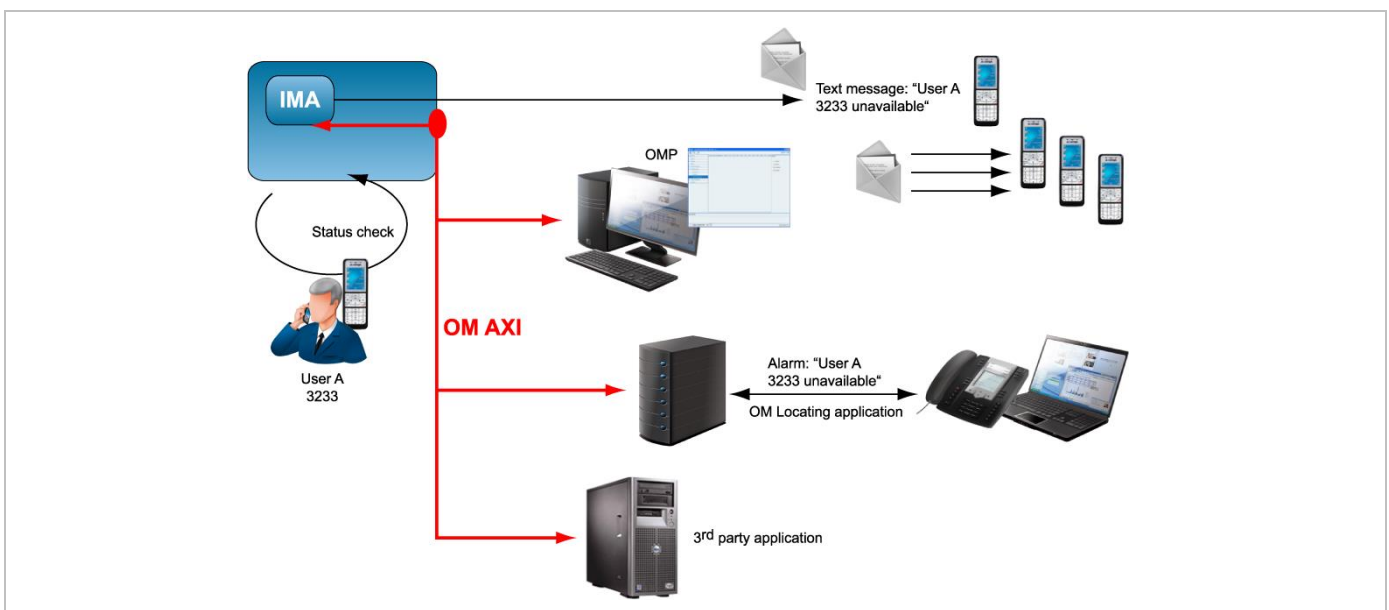



The status information is available via OM AXI and OMP.



**IMPORTANT :** To address customer specific requirements, external applications (e.g. 3rd party software) can provide an addapted functionality of the user monitoring or even more just by using OM AXI. This can be completed by the use of the XML terminal interface.

In addition to the standard request, response and notification messages, the OMM generates alarm triggers if a user becomes unavailable. The alarm triggers can be consumed by the OM IMA, OM Locating or another application using OM AXI. If a user becomes available again, the OMM informs about this status change by sending an additional alarm trigger.

The specific alarm trigger “LOC-ERR-USERSTATE” is defined for locating. This alarm trigger is displayed in the OM Locating application with the  icon.

#	State	Assignee	Location	Date	Type	Sender	Recipient
1	 Escalated		 default/RFP43 LP	28.06.12 16:12:13		Lutz	
0	 Escalated		 default/RFP43 LP	28.06.12 16:05:02		Lutz	

Type  
Alarm SCS

**IMPORTANT :** The OM Locating application does not list users who are not locatable, e.g. locating not enabled for the users or because they have no DECT phone assigned. Therefore, the OM Locating application can not handle the LOC-ERR-USERSTATE with the escalation of the DECT phones assignment state (HAS).

## 7.29.2 STATUS ATTRIBUTES AND VALIDATION MECHANISMS

The combined user status (CUS) is the sum of the specific status information.

The CUS is calculated based on the following rules:

- Specific states which are set to “Unknown” are ignored.
- CUS is set to “Available” if none of the specific states is set to “Warning”, “Unavailable” or “Escalated”.
- CUS is set to “Warning” if at least one of the specific states is set to “Warning” and none of the other states is set to “Unavailable” or “Escalated”.
- CUS is set to “Unavailable” if at least one of the specific states is set to “Unavailable” and none of the other states is set to “Escalated”.
- CUS is set to “Escalated” if at least one of the specific states is set to “Escalated”.

The status “Unavailable” is changed to “Escalated” after the escalation timeout has elapsed and an alarm trigger has been generated.

### 7.29.2.1 Handset Assignment Status (HAS)

A DECT phone must be assigned to the user otherwise the status is “Unavailable”.

#### Fixed user device relation

A DECT phone can be assigned permanently to a user (fixed user device relation). Then the status is always “available”.

### **Dynamic user device relation**

A DECT phone can be dynamically assigned to a user (dynamic user device relation) and login and logout on a DECT phone is used.

If the user is logged out (unbound), the status is “Unavailable”. If the user is logged in (dynamic), the status is “available”. Login and logout also change the SIP registration.

**Precondition:** The user must exist in the OMM database.

### **7.29.2.2 Handset Subscription Status (HSS)**

The DECT phone must be subscribed otherwise the status is “Unavailable”.

**Precondition:** A DECT phone must be assigned to the user.

### **7.29.2.3 Handset Registration Status (HRS)**

The DECT phone must be attached / signed in (successful location registration) otherwise the status is “Unavailable”

The DECT phone may sent a detach message if it is switched off.

**Precondition:** A DECT phone must be assigned to the user (fixed, logged in) and the DECT phone is subscribed.

### **7.29.2.4 Handset Activity Status (HCS)**

A communication over the air must occur regularly otherwise the status is “Unavailable”.

#### **Passive monitoring**

With every activity between DECT phone and the DECT system (e.g. call setup) the activity information will be updated (last activity, current activity status). This indicates when the DECT phone was the last time able to communicate with the DECT system i.e. within the area of coverage, sufficient battery level, etc. There must be an activity within the timeframe defined by the Activity timeout 1 (min. 30 minutes, max. 1440 minutes).

Any activity between the DECT phone and the systems sets the status to “available”.

#### **Active monitoring**

Each DECT phone, that shall be monitored actively, will refresh its registration automatically within the “Activity timeout 2” (min. 5 minutes, max. 60 minutes). Each activity sets the status to “available”.

#### **Active and passive monitoring**

If the DECT phone was not active for the period of time defined by the activity timeout, the OMM automatically initiates an activity between the DECT phone and the DECT system to check the DECT connectivity. If this fails, the OMM sets the status to “Unavailable” but tries to connect to the DECT phone two times more within the next 2 minutes.

The OMM then continues to check the DECT connectivity base on the configured time frame. If the status is already “Unavailable”, the OMM does not verify the status by two additional tests within 2 minutes. If a check was successful, the status is set to “available”.

If a DECT phone could not be reached (e.g. during call setup or messaging delivery), the OMM tries to connect to the DECT phone two times more within the next 2 minutes before the status is set to “Unavailable”.

**Precondition:** A DECT phone must be assigned to the user (fixed, logged in). The DECT phone is subscribed and attached (at least once).

#### 7.29.2.5 SIP User Registration Status (SRS)

The user must be successfully registered at the configured SIP registrar otherwise the status is “Unavailable”.

A SIP registration is initiated automatically by the OMM during start-up if the user’s DECT phone was attached to the DECT system before restart/failover.

The SIP registration will not initiated automatically by the OMM during start-up if

- the user has no assigned DECT phone (fixed user device relation, login),
- the DECT phone is not subscribed or
- the DECT phone was detached (e.g. switched off) before restart/failover.

A user will be deregistered if

- the DECT phone subscription is deleted/terminated,
- the user logs off from a DECT phone or
- the DECT phone is detached (e.g. switch off).

**Precondition:** A DECT phone must be assigned to the user (fixed, logged in). The DECT phone is subscribed and attached (at least once).

#### 7.29.2.6 Silent Charging Status (SCS)

If silent charging is enabled and the DECT phone is put into the charger, the DECT phone is in silent charging mode and does not indicate incoming calls with an audible signal. The DECT phone must not be in silent charging mode otherwise the status is “Unavailable”.

**Precondition:** A DECT phone must be assigned to the user (fixed, logged in). The DECT phone is subscribed and attached/signed in to the DECT system.

#### 7.29.2.7 Call Diversion Status (CDS)

The user has no immediate call diversion (unconditional call forwarding) configured otherwise the status is “Unavailable”.

If the user has configured a call diversion for “No answer” / “Busy no answer” with a forward time ‘0’, this will be handled by user monitoring like unconditional call forwarding.

**Precondition:** The user must exist in the OMM database. The SIP supplementary service “Call forwarding / Diversion” is enabled in the OMM (see pages 71 and 146).

#### 7.29.2.8 Handset Battery Status (HBS)

The battery level of the DECT phone must be greater than the configured threshold value; otherwise the status is set to “Warning”.

**Precondition:** A DECT phone must be assigned to the user (fixed, logged in). The DECT phone is subscribed and attached. Delivery of battery level is supported.<sup>1</sup>

### 7.29.2.9 Software Status (SWS)

The DECT phone software must provide the minimum of required features which could be controlled by the current OMM version. Therefore the appropriate minimum DECT phone software version is hard coded in the OMM and validated by user monitoring. The status will be set to “Warning” if the DECT phone software version is less than the hard coded value of the OMM.

Delivery of the software version is supported only by Mitel 600 devices.

**Precondition:** A DECT phone must be assigned to the user (fixed, logged in). The DECT phone is subscribed and attached.<sup>2</sup>

## 7.29.3 ESCALATION

If the OMM detects the unavailability of a user (marked as “unavailable”), this will be escalated only once by submitting a warning alarm trigger via OM AXI.

If the OMM detects finally the unavailability of a user (marked as “unavailable/escalated”), this will be escalated only once by submitting an alarm trigger via OM AXI.

The user must become available again before the unavailability of a user will be escalated the next time.

## 7.29.4 ALARM TRIGGERS

- The “UMON-WARNING-USERSTATE” alarm trigger is used to escalate the detection of the unavailability.
- The alarm triggers “UMON-ERROR-USERSTATE” and “LOC-ERROR-USERSTATE” are used to escalate the final detection of the unavailability.
- The “UMON-OK-USERSTATE” alarm trigger is sent by the OMM if a user becomes available again.

These are static, predefined alarm triggers like “SOS” and “MANDOWN” which do not have a telephone number to call.

The alarm triggers “UMON-WARN-USERSTATE”, “UMON-ERR-USERSTATE” and “LOCERR-USERSTATE” provide information about the cause why the user became unavailable (one or more of status attribute IDs: HAS, HSS, HRS, HCS, SRS, SCS, CDS, ...).

## 7.29.5 OM LOCATING APPLICATION

To be visible in the OM Locating application, the monitored user must be locatable. Tracking can be enabled.

The alarm trigger “LOC-ERR-USERSTATE” is handled like SOS (🚨), ManDown (❤️) but no voice call will be established.

---

<sup>1</sup> The Mitel 600 DECT phone family provides battery status information if the DECT phones are updated to the current software version.

<sup>2</sup> The Mitel 600 DECT phone family provides software version information if the DECT phones are updated to the current software version.

The alarm trigger “LOC-ERR-USERSTATE” will be displayed as a Customer specific event (🔔).

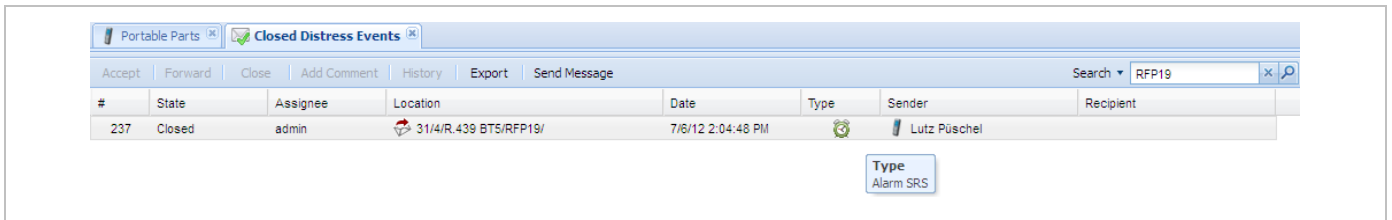

### 7.29.6 LICENSING AND SYSTEM CAPACITIES

The “User monitoring” feature does not require a specific license.

The number of monitored users is limited, as follows:

#### RFP OMM

- Passive monitored users: 30
- Active monitored users: 20

#### PC OMM

- Passive monitored users: 300
- Active monitored users: 200

An OMM system health state will be set if the number of monitored users exceeds the system capabilities. In this case also an associated health state alarm trigger will be generated.

### 7.29.7 CONFIGURATION

User monitoring can be administered via the OMP.

#### 7.29.7.1 “System settings: User monitoring” Menu

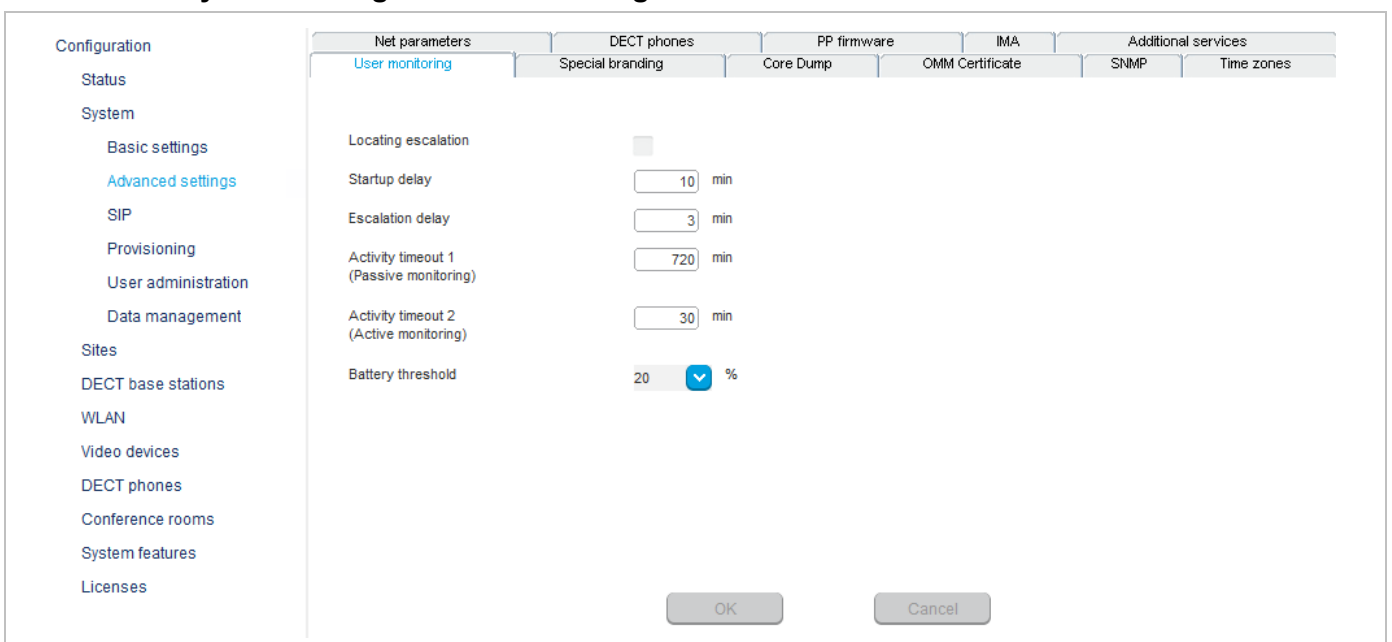

The following parameters can be configured on system level.

- **Locating escalation:** If this option enabled, the alarm trigger “LOC-ERR-USERSTATE” will be generated by the OMM. Default setting is “off”.
- **Start-up delay:** The start-up delay defines the period of time the user monitoring start-up is delayed (between 2 and 15 minutes) after failover or system start-up.
- **Escalation delay:** The escalation delay defines the period of time the user monitoring will wait before the unavailable status is escalated.
- **Activity timeout 1:** The activity timeout 1 defines the maximum time (between 30 and 1440 minutes) between user activities in passive monitoring mode.
- **Activity timeout 2:** The activity timeout 2 defines the maximum time (between 5 and 60 minutes) between user activities in active monitoring mode.
- **Battery threshold:** The battery threshold defines the minimum battery load (between 0 and 100% in steps of 5%).

### 7.29.7.2 “DECT Phones” Menu

Configuration	User ID	Name	Number/SIP user n...	Login/Add ID	User rel. type	Rel. devic...	Active	External
Status	0x001	x25052 612d	25052		Fixed	0x001	✓	✗
	0x002	x25053 622d	25053		Fixed	0x002	✓	✗
System	✓ 0x003	x25054 622d	25054		Fixed	0x003	✓	✗
	0x004	x42052 622d	42052		Fixed	0x004	✓	✗
Sites	0x04C	simu pp 0	256001		Fixed	0x05F	✗	✗
DECT base stations	0x04D	simu pp 1	256002		Fixed	0x060	✗	✗
	0x04E	simu pp 2	256003		Fixed	0x061	✗	✗
WLAN	0x04F	simu pp 3	256004		Fixed	0x062	✗	✗
Video devices	0x050	simu pp 4	256005		Fixed	0x063	✗	✗
	0x051	simu pp 5	256006		Fixed	0x064	✗	✗
DECT phones	0x052	simu pp 6	256007		Fixed	0x065	✗	✗
Overview	0x053	simu pp 7	256008		Fixed	0x066	✗	✗
Users	0x054	simu pp 8	256009		Fixed	0x067	✗	✗
	0x055	simu pp 9	256010		Fixed	0x068	✗	✗
Devices	0x056	simu pp 10	256011		Fixed	0x069	✗	✗
	0x057	simu pp 11	256012		Fixed	0x06A	✗	✗
Conference rooms	0x058	simu pp 12	256013		Fixed	0x06B	✗	✗
	0x059	simu pp 13	256014		Fixed	0x06C	✗	✗
System features	0x05A	simu pp 14	256015		Fixed	0x06D	✗	✗
	0x05B	simu pp 15	256016		Fixed	0x06E	✗	✗
Licenses	0x05C	simu pp 16	256017		Fixed	0x06F	✗	✗
	0x05D	simu pp 17	256018		Fixed	0x070	✗	✗

The following parameter can be configured on user level.

**Monitoring mode:** The user monitoring mode can be set to **Off**, **Passive** or **Active**. **Off** disables user monitoring. **Passive** and **Active** enable user monitoring and control the mode of the DECT phone activity status supervision. Default setting is **Off**.

If user monitoring is activated, the **VIP** option in the **DECT Phones -> Users -> SIP** tab for the user will be set automatically (see page 191). The **VIP** option will not be reset if the user monitoring mode is set to “Off”.

### 7.29.7.3 “DECT Phones -> User monitoring” Menu

The status of all monitored users is presented by the OMM in the **DECT Phones -> User monitoring** menu.

### 7.29.7.4 User Configuration Files

The parameter “UD\_UserMonitoring” controls the monitoring for a user. The parameter can be set to “Off”, “Passive”, or “Active”.



### 7.29.7.5 OM IMA Application

If messages shall be sent out by the OM IMA application, the administrator must configure appropriate alarm scenarios for the alarm triggers in the OM IMA configuration file:

- UMON-OK-USERSTATE
- UMON-WARN-USERSTATE
- UMON-ERR-USERSTATE

### 7.29.8 START AND FAILOVER

The availability status is set to “Unknown” at start-up.

The monitoring feature does not escalate any user status during start-up until a configurable delay of min. 2 minutes and max. 15 minutes has elapsed.

The start-up delay should be adjusted according to the system start-up. The system start-up depends on the actual physical configuration, infrastructure components and parameter settings.

The statistic counter “Sync RFP start-up time” and “Sync Cluster start-up time” help to find an appropriate value for the start-up delay.

As soon as the start-up delay has elapsed, the status attributes are checked and the availability status will be determined. If the result is “Unavailable”, the status will be escalated.

The SIP registration process runs independently from the user monitoring start-up and infrastructure start-up. Monitored users as well as other users, who have the VIP flag set, are registered first.

### 7.29.9 SUPPORTED DECT PHONES

The Mitel 600 DECT phone family is fully supported.<sup>1</sup>

The following states are managed independent of the DECT phone type:

- Handset assignment status (HAS)
- Handset subscription status (HSS)
- Handset registration status (HRS)
- Handset activity status (HCS)<sup>2</sup>
- SIP user registration status (SRS)
- Call diversion status (CDS)

---

<sup>1</sup> The DECT phones must be equipped with the software version that corresponds to the SIP-DECT® release. Otherwise, functionality may be limited.

<sup>2</sup> GAP devices do not support the active monitoring.

## Notes on Mitel 142d

The Mitel 142d DECT phones are supported by SIP-DECT and have an enhanced feature set compared to GAP DECT phones. For Mitel 142d the availability status is always set to “Warning” because of the limited feature set.

User ID	Name	Number	Rel. devi...	Mode	CUS	HAS	HSS	HRS	HCS	SRS	SCS	CDS	HBS	BTS	SWS
0x001	142d	3000	0x001	Active	⚠	✓	✓	✓	✓	✓		✓			⚠

The following states are not supported:

- Handset battery state (HBS)  
always set to “Unknown”
- Software Status (SWS)  
always set to “Warning” to indicate the limited feature set
- Silent charging state (SCS)  
always “Unknown”

If the DECT phone is put into silent charging mode then it sends a “Detach”, like it is switched off.

## Comments on GAP DECT phones

GAP DECT phones are supported by SIP-DECT with a basic feature set. The availability status is always set to “Warning” because of the limited feature set.

User ID	Name	Number	Rel. devi...	Mode	CUS	HAS	HSS	HRS	HCS	SRS	SCS	CDS	HBS	BTS	SWS
0x001	GAP	3000	0x001	Passive	⚠	✓	✓	✓	✓	✓		✓			⚠

The following states are not supported:

- Handset battery state (HBS)  
always “Unknown”
- Software Status (SWS)  
always set to “Warning” to indicate the limited feature set
- Silent charging state (SCS)  
always “Unknown”

GAP DECT phones do not support the active monitoring (Handset activity status /HCS). In general, there is no guarantee for the correct interworking of the 3<sup>rd</sup> party DECT phone with SIP-DECT.

## 7.29.10 RESTRICTIONS

The described mechanisms check the status information in the OMM. Therefore the solution has certain limitations.

The OMM determines the availability of the DECT device which does not necessarily represents the availability of the user.

- It is not possible to determine whether a user actually carries his device with or not.
- The check of the availability does not include the infrastructure to which the OMM is connected (e.g. call manager, etc.). A user appears as available even if the call manager fails.
- Feature (especially call diversion) when managed by the call server can undermine the monitoring.
- If a user is removed from the OMM, the monitoring stops without escalation. It cannot be checked if the user belongs to an alarm scenario configured in the alarm server or any other application scenario.

## 7.30 SRTP

Together with the new RFP 35/36/37 IP and 43 WLAN, SIP-DECT supports SRTP to encrypt the RTP voice streams and SDES for the SRTP key exchange.

There are three options for SRTP:

- **SRTP only:** only SRTP calls will be accepted, all other will be rejected (the audio part of the SDP contains RTP/SAVP)
- **SRTP preferred:** all calls will be initiated as secured, but accepted if they are not secured (the audio part of the SDP contain RTP/AVP)
- **SRTP disabled:** only RTP calls will be initiated as not ciphered and incoming ciphering algorithm will be not accepted. All communications are established unencrypted.

SIP-DECT provides the cipher suite AES\_CM\_128\_HMAC\_SHA1\_80.

SRTP calls from DECT phones with DECT handover require that the SRTP functionality must be homogenously available on all effected RFPs. To allow mixed installations with the older RFP types 32/34 and 42 WLAN, the SRTP feature can be enabled or disabled per site. Whereby, SRTP can only be activated on sites with only RFPs 35/36/37/43 included.

**IMPORTANT :** A handover of an SRTP call to a site with disabled SRTP will drop the call.

**IMPORTANT :** SDES specifies as key exchange method the negotiation over SDP included in the SIP signaling. Therefore, we recommend to use TLS to encrypt the key exchange.

**IMPORTANT :** Please enable “SRTP = only” mode exclusively when all communication can be established with SRTP. Depending on the call server some features or gateways may not offer SRTP.

## 7.31 SIP OVER TLS

The transport protocol modes “TLS” or “Persistent TLS” enable a private and authenticated signaling, including safe key exchange for SRTP encryption.

The transport protocol and all further security settings can be set via the OMP **System** -> **SIP**-> **Security** tab and the OMP **System** -> **SIP**-> **Certificate Server** tab.

The following parameters can be set:

### General

- **Transport protocol:** The protocol used by the OMM to send/receive SIP signaling. Default is “UDP”.
- **Persistent TLS Keep alive timer active:** When enabled and “Persistent TLS” is selected as transport protocol, the OMM sends out keep alive messages periodically to keep the TLS connection open.

- **Persistent TLS Keep alive timer timeout:** Specifies the time, in seconds, between keep-alive messages sent out by the OMM. Valid values are “10” to “3600”. Default is “30” seconds.
- **Send SIPS over TLS active:** When enabled and “TLS” or “Persistent TLS” is selected as transport protocol, the OMM uses SIPS URIs in the SIP signaling. Default is “ON”.
- **TLS authentication:** When enabled and “TLS” or “Persistent TLS” is selected as transport protocol, the OMM validates the authenticity of the remote peer via exchanged certificates and the configured “Trusted certificates”. Default is “ON”.
- **TLS common name validation:** When enabled and “TLS authentication” is selected the OMM validates the “Alternative Name” and “Common Name” of the remote peer certificate against the configured proxy, registrar and outbound proxy settings. If there is no match an established TLS connection will be closed immediately.

**PEM file import**

- Allows the manual import of Trusted, Local Certificates and a Private Key in PEM file format.

The following parameters can only be read and should ease the handling of certificates:

- **Trusted Certificates:** The number of imported trusted certificates.
- **Local Certificate chain:** The number of imported certificates in the local certificate chain.
- **Private Key:** Is a private key imported or not.

**Certificate server**

Optionally is also an automatic import of Trusted, Local Certificates and a Private Key files from an external server possible. This can be configured on the “Certificate Server” tab.

The following parameters allow an automatic import:

- **Active:** Enable or disable the automatic import.
- **Protocol:** Selects the preferred protocol (FTP, TFTP, FTPS, HTTP, HTTPS, SFTP)
- **Server:** IP address or name of the server
- **User Name / Password / Password confirmation:** The server account data if necessary.
- **Path:** The path on the server to certificate files.
- **Trusted certificate file:** The name of the PEM file on the given server including the trusted certificates.
- **Local certificate file:** The name of the PEM file on the given server including the local certificate or a certificate chain.
- **Private key file:** The name of the PEM file on the given server including the local key.

**7.31.1 CERTIFICATES**

The use of “TLS” or “Persistent TLS” requires the import of certificates to become operational.

Item	When Needed	Setting
Trusted Certificates	For TLS and Persistent TLS	A PEM file with a list of all (self-signed) CA certificates needed to verify remote certificates. May also contain trusted intermediate certificates instead of or in addition to self-signed certificates In many cases there is only one certificate in this list:

		The self-signed certificate which is used by the SIP proxy and registrar or which was used to sign that certificate.
Local Certificate	For TLS: Always	A PEM file with the OMM's certificate chain
Private Key	For Persistent TLS: Only if the server verifies the client certificate	A PEM file with the OMM's private key

All certificates and keys must be provided as X.509 certificates in PEM file format. They must use the RSA algorithm for their keys and signatures and MD5 or SHA-1 for their hashes.

Although PEM files usually contain a textual description of the certificate, only the Base64-encoded portions between

```
-----BEGIN CERTIFICATE-----
```

and

```
-----END CERTIFICATE-----
```

are actually evaluated. However, the files can be uploaded to the OMM with their full content.

There are two sets of certificates which can be set up in the OMM, which are described in the following sections.

### Trusted Certificates

The trusted certificates are used to verify the signatures of certificates sent by remote hosts. The corresponding PEM file may contain multiple certificates. Their order is not relevant. Certificates are searched in the trust store according their subject name, the key identifier (if present), and the serial number as taken from the certificate to be verified.

### Local Certificates

The local certificate or local certificate chain is sent to remote hosts for authentication.

In corresponding PEM files the host certificate must be in the first position, followed by intermediate certificates if applicable. The last certificate is the self-signed root-certificate of the CA. The root certificate may be omitted from the list, as the remote host must possess it anyway to verify the validity. This means that if there are no intermediate certificates, this file may contain only one single certificate.

## 7.31.2 PRIVATE KEY

The Private Key is also contained in a PEM file. The *Local Certificate* must match to the *Private Key*. Although PEM files may contain a textual description of the key, only the Base64-encoded portions between

```
-----BEGIN RSA PRIVATE KEY-----
```

and

-----END RSA PRIVATE KEY-----

is actually evaluated. However, the file can be uploaded to the OMM with its full content.

### 7.31.3 TLS TRANSPORT MODE

The OMM distinguishes the both TLS transport modes **TLS** and **Persistent TLS**.

When the OMM is configured to use **TLS** (Transport protocol: TLS), TLS connections to remote peers, e.g. SIP proxies and registrars, are connected as needed. For TLS connections initiated by the OMM, it is a TLS client. If a remote peer sets up a TLS connection, the OMM is the TLS server. Connections are closed when they have not been in use for a certain time. The terms *server* and *client* refer to TLS connections below, not to SIP transactions.

The OMM always verifies the server certificate when it sets up an outgoing connection and it verifies the client certificate on incoming connections. Therefore following configuration parameters must be set for this mode: *Trusted Certificates*, *Local Certificate* and *Private Key*.

When the OMM is configured to use **persistent TLS** (Transport protocol: Persistent TLS), it sets up TLS connections to SIP Servers and keeps them connected. When a connection is closed for whatever reason, the OMM tries to re-establish it immediately. It does not accept incoming connections from remote ends. Thus the OMM is always TLS client when Persistent TLS is in use.

The advantage of Persistent TLS is a faster call setup time and lower processing power needed on both sides.

The OMM always verifies the server certificate, therefore following configuration parameters must be set for this mode: *Trusted Certificates*

If the server verifies the client certificate, additionally *Local Certificate* and *Private Key* must be set.

### 7.31.4 VERIFICATION OF REMOTE CERTIFICATES

When “TLS authentication” is “ON”, a remote certificate is verified by the OMM as follows:

The signature of the certificate is checked with the public key of the signing certificate. The certificate chain is checked until a *Trusted Certificate* is found. If self-signed certificate is found which is not trusted, the verification fails.

The current time must be in the validity period of the certificate. For this mechanism a correct system time must be provided (e.g. NTP).

If one or more of these checks fail, the TLS connection will be closed.

**Please note:** All certificates are only valid for a limited time given by the issuer. As soon as the validity is expired no further communication is possible. The certificates must be replaced before to prevent a breakdown of call services.

When “TLS authentication” is “OFF”, the OMM verifies the remote certificates and logs any failure but the established TLS connection will not be closed in case of verification failures.

**IMPORTANT :** To prevent man-in-the-middle attacks we recommend not to disable the “TLS authentication” in unsecure environments. We recommend setting “TLS authentication” and “TLS common name validation” to “ON” in any unsecure environments for the best security.

### 7.31.5 ADDITIONAL SECURITY CONSIDERATIONS

For highest security requirements there are additional considerations to be taken into account when enrolling an OpenMobility system.

To prevent manipulations during the initial upload of certificates and keys to the OMM completely, this should be done in a small private network without a physical connection to an insecure network.

**IMPORTANT :** To prevent manipulation of certificates and keys in unsecure environments we recommend not to use the automatic import of certificates and keys. Especially the unsecure protocols TFTP, FTP and HTTP must be avoided. It is also recommended to protect the selected protocol with a login to prevent unauthorized access to the private key file.

Furthermore, it is important that the root and administrator passwords of the OpenMobility system are safe, because with these passwords an attacker could change the configuration to manipulate the system in various ways.

Although all keys and certificates in the database are encrypted, an automated database backup or download could be a security leak if the network, transport protocol or servers used are not protected against manipulations.

### 7.32 DECT ENHANCED SECURITY

Security aspects in the DECT standard have been improved after concerns were raised in the market in recent years. Therefore various enhancements have been introduced.

The usage of many security features, which were already available in the DECT standard (respectively GAP) from the beginning, was left optional for the devices. These mechanisms became mandatory together with CAT-iq. Almost each of these functionalities was present and used within SIP-DECT right from the start.

Furthermore, some new features have been added to GAP:

- Encryption of all calls (not only voice calls)
- Re-keying during a call
- Early encryption

Each procedure brings additional guarantee on security and is an integral part of the SIP-DECT solution.

The feature set can be enabled or disabled per site. This distinction is necessary due to the fact, that enhanced security is available with RFPs 35/36/37/43 only.

From release 5.0 on, when DECT enhanced security is enabled, every connection will be encrypted, not only voice calls, but also such as service calls (e.g. list access) or messaging.

Additionally, the cipher key used for encryption during an ongoing call is changed every 60 seconds.

Finally, every connection is encrypted immediately upon establishment to protect the early stages of the signaling such as dialing or CLIP information.

DECT enhanced security is only supported together with Mitel 602 DECT phones. Older terminals (e.g. 6x0d or 142d) or GAP phones will still operate as ever, but not provide the new security mechanisms.

## 7.33 MIGRATION OF RFP SL35 IP FROM SIP-DECT LITE 3.1 TO SIP-DECT 6.1

The SIP-DECT Lite solution realized a single-cell DECT network that offered only limited radio coverage and was operated with one RFP SL35 IP. The SIP-DECT Lite solution was part of the SIP-DECT product family that offered larger radio coverage by realizing multi-cell DECT networks with up to 2.56 RFPs.

You can integrate the RFP SL35 IP to a multi-cell SIP-DECT network. The migration from SIP-DECT Lite to the current release of the standard SIP-DECT system is supported. During the migration the SIP-DECT Lite software is replaced by the standard SIP-DECT software on the RFP SL35 IP and a reset to the factory setting is performed. All configuration data are removed from the base station.

The following migration process must be performed.

**Precondition: Unique UNLOCK.xml file is available for the specific RFP SL35 IP.**

- 1 Remove the USB flash memory from the RFP SL35 IP and plug it into your computer.
- 2 Copy the unlock.xml file onto the USB flash memory.
- 3 Copy the standard SIP-DECT SW (iprpf3G.dnld) onto the USB flash memory of the RFP.
- 4 Check if the following files are on the USB flash memory (no other files should be on the USB flash memory except SIP-DECT™ Lite DB backup field “omm\_conf.txt” which is not relevant).
  - a. PARK.xml
  - b. UNLOCK.xml
  - c. iprpf3G.dnld
- 5 Remove the USB flash memory from your computer and plug into the RFP SL35 IP.
- 6 The migration process starts automatically after plugging the USB flash memory into the RFP.
- 7 Wait for the RFP reboot and start-up. Do not interrupt the electric power during this process.
- 8 The SW update for RFPs in standard SIP-DECT installations are provided by other means than to copy the SW on the USB flash memory. Therefore the iprpf3G.dnld must be removed from the USB flash memory.

Make sure that the PARK.xml and UNLOCK.xml remain on the USB flash memory.
- 9 Also after the migration, make sure that the USB flash memory is always plugged in the RFP.
- 10 Now, the RFP SL35 IP has the standard SIP-DECT SW and the UNLOCK.xml file and can be operated in standard SIP-DECT installations. Please follow the standard procedures to setup a SIP-DECT installation.



## 8 MAINTENANCE

### 8.1 SITE SURVEY MEASUREMENT EQUIPMENT

If a SIP-DECT installation must be planned, a sufficient distribution of DECT base stations that meets the requirements for reliable synchronization and connectivity to the DECT phones is necessary. The site survey kit may help you. It comprises:

- One measuring RFP with its own power supply.
- A tripod and a battery for the RFP.
- Two reference DECT phones with chargers.
- Battery chargers.
- Optional a measuring DECT phone which can monitor other makers DECT radio sources.

### 8.2 CHECKING THE MITEL HANDSET FIRMWARE VERSION

You can display the version information of a Mitel 600 or Mitel 142d DECT phone with a few keystrokes. Check the firmware version to determine whether an update is required to overcome any user issues.

- 1 Press the **Menu** soft key.
- 2 Select **System** (only to highlight).
- 3 Press **OK**.
- 4 Select **Version Number**.
- 5 Press **OK**.

The display shows the software and the hardware version of the Mitel DECT phone.

### 8.3 DIAGNOSTIC

#### 8.3.1 MITEL DECT PHONE SITE SURVEY MODE

You can switch a Mitel 600 or Mitel 142d DECT phones into “site survey mode” with a few keystrokes. In this mode the phone will display the RFPs and the actual field strength of the receiving signal in dBm.

- 1 Press the **Menu** soft key.
- 2 Enter the following key sequence “\*\*\*76#” (Mitel 600 ) or “R\*\*\*76#” (Mitel 142d).
- 3 Select Site Survey.
- 4 Press OK.
- 5 To leave the site survey mode, switch the phone off and on again.

The following display is shown on the Mitel DECT phone:

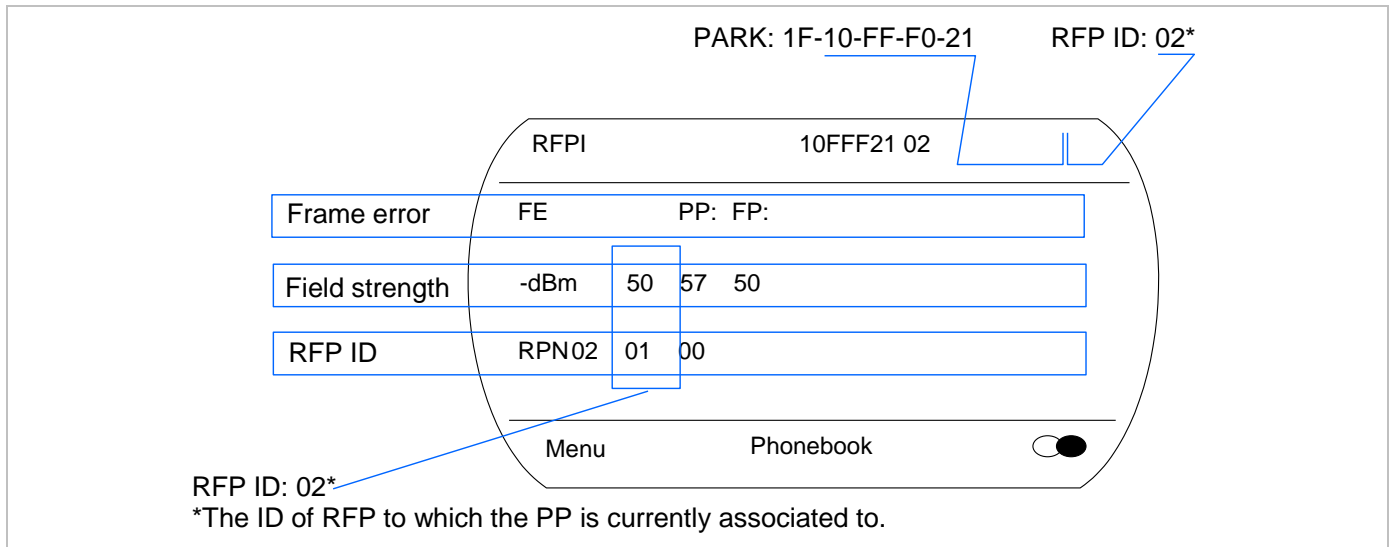

In this example the DECT phone is currently connected to the RFP with the number 02. The RFPs 01 and 00 are also visible. The number “10FFF21 02” on the upper right side refers to the PARK (Example 1F-10-F2-21) of the SIP-DECT system and to the RFP to which the phone is currently connected to.

### 8.3.2 MITEL HANDSET AUTO CALL TEST MODE

You can switch a Mitel 600 or Mitel 142d DECT phones into “auto call test mode” with a few keystrokes. In this mode the phone will call a specified number cyclically. You can use this feature to generate traffic for test purposes. This mode is also active if the phone is on the charger.

- 1 Press the **Menu** soft key.
- 2 Enter the following key sequence “\*\*\*76#” (Mitel 600 ) or “R\*\*\*76#” (Mitel 142d).
- 3 Select Auto Call Test.
- 4 Press OK.
- 5 Enter the phone number to call.
- 6 Press OK.
- 7 Enter a number of seconds between two calls.
- 8 Press OK.
- 9 Enter a number of seconds a call shall be active.
- 10 Press OK. The test will be started automatically.
- 11 To stop the test, switch the phone off and on again.

### 8.3.3 MITEL HANDSET AUTO ANSWER TEST MODE

You can switch a Mitel 600 or Mitel 142d DECT phone into “auto answer test mode” with a few keystrokes. In this mode, the phone answers incoming calls automatically. You can use this feature together with phones in the “auto call test mode” (see section 8.3.2) for test purposes. This mode is also active if the phone is on the charger.

- 1 Press the **Menu** soft key.
- 2 Enter the following key sequence “\*\*\*76#” (Mitel 600 ) or “R\*\*\*76#” (Mitel 142d).
- 3 Select Auto Answer.
- 4 Press OK.
- 5 Enter a number of seconds the phone shall ring before it will answer the call.
- 6 Press OK.
- 7 Enter a number of seconds a call shall be active.
- 8 Press OK. The test will be started automatically.
- 9 To stop the test, switch the phone off and on again.

### 8.3.4 SYSLOG

The OpenMobility Manager and the RFPs are capable of propagating Syslog messages conforming to RFC 3164 (see /13/). This feature together with the IP address of a host collecting these messages can be configured.

Syslog must be enabled by:

- DHCP using the public options 227 and 228.
- Setting the syslog daemon server and port via the web interface.

To set up the syslog via DHCP or the OM Configurator has the advantage that syslogs are available in earlier states of the RFP startup.

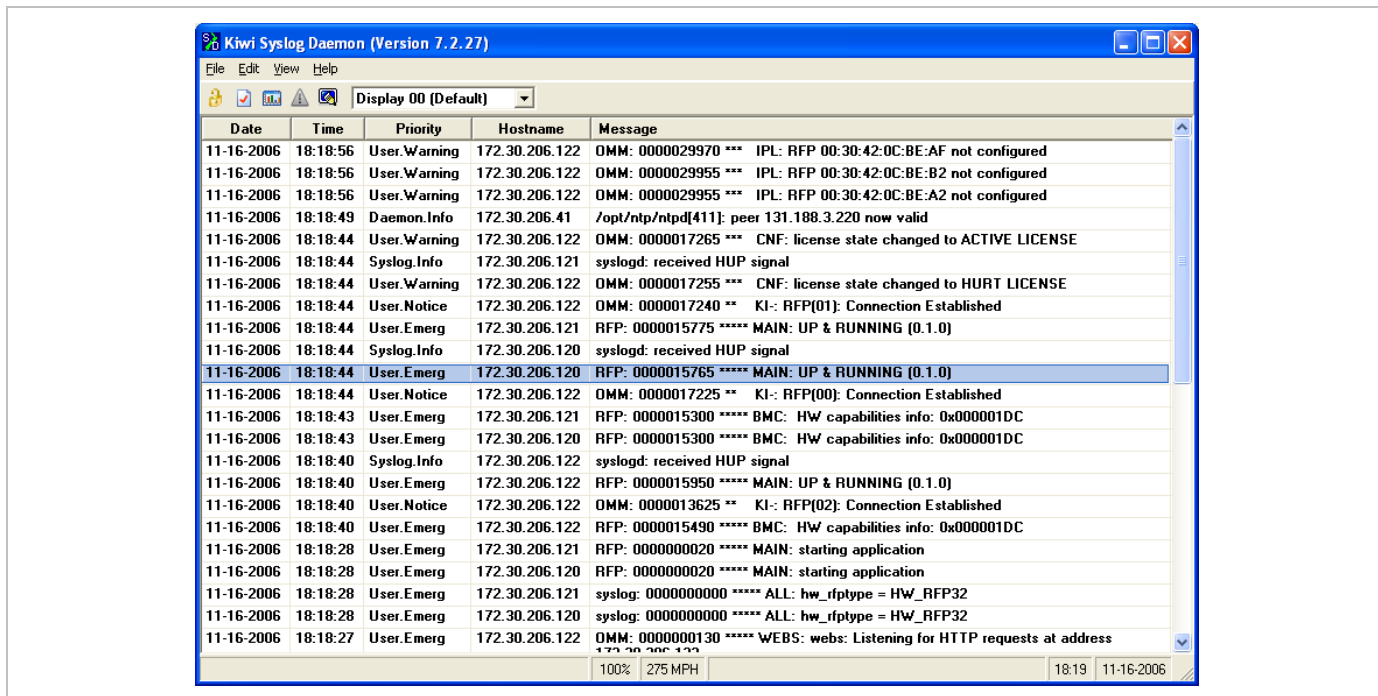

The level of syslog messages in the default state allows the user to have control over the general system state and major failures.

### 8.3.5 SSH USER SHELL

Each RFP offers a lot of commands within the SSH shell. Most of them are useful for diagnostics and may help experts to resolve failures.

**Note:** Some commands can harm the system operation.

The SSH access of an RFP is open if

- the RFP is connected to an OMM and the “Remote Access” is switched on or
- the RFP is not connected to an OMM.

To activate the SSH access of an RFP that has a connection to an OMM, enable the **Remote access** checkbox on the OMM **System settings** web page (see section 5.4.1.1). In the OMP, the SSH access is activated/deactivated in the **General** tab of the **System -> Basic settings** menu (see section 6.5.1).

#### 8.3.5.1 Login

To log into the SSH user shell:

- 1 Open an SSH session to the IP DECT base station with the “Full access” user name.
- 2 Enter the password for the “Full access” account (see also 7.17.1).

The output should look like:

```
Welcome to IP RFP OpenMobility SIP Only Version 2.1.x

last reset cause: hardware reset (Power-on reset)

omm@172.30.206.94's password:
omm@172.30.206.94 >
```

#### 8.3.5.2 Command Overview

Type `help` to get a command overview:

Command	Description
exit,quit,bye	Leave session
ommconsole	OMM console
ip_rfpconsole	RFP console
rfpm_console	RFP manager console
wlan_console	WLAN console
ics_console	ICS console
ldb	View / set local configuration (OmConfigurator)
setconsole	Duplicate messages to console
noconsole	Do not duplicate messages to console
dmesg	Messages from last boot
logread	Last messages
su	Switch to user root

ping	Well known ping
tracert	Well known tracert
free	Well known free
ps	Well known ps
top	Well known top
ifconfig	Well known ifconfig
uptime	Well known uptime
reboot	Well known reboot
date	Well known date (time in UTC)

### 8.3.5.3 OMM Console On Linux Server

You can call the OMM console on the Linux server which runs the OMM using the “ommconsole” command. Log on as root as it is necessary to install and/or update OMM.

**IMPORTANT :** If you not login as root to open the OMM console then the path to ommconsole is not set and you must enter the whole path “/usr/sbin/ommconsole” to start the OMM console.

### 8.3.5.4 RFP Console Commands

If you type `ip_rfpconsole` you are able to use the following commands on each RFP:

Command	Description
?	Displays Command Help Table
bt	Bluetooth commands
confmix	Displays status of conference mixer
help	Displays Command Help Table
logger	Send a string to the syslog daemon
deftrc	Resets all trace settings to default
runtime	Reports the process runtime
mem	Show memory and heap
exit	Leave this console
heap	Shows heap buffer statistics
heapcheck	Verifies the guard space of all via dross allocated buffer. Heap functions are locked during check
heapdetails	Print detailed heap usage
jpeg	Jpeg helper commands
lu10	Lu10 SDU <-> PDU converter
mclose	Close a media channel

Command	Description
mconf	Configure IP settings for a media channel
media	Display state of media channels
mopen	Open a media channel
mroute	Display media routes
mstart	Start a media channel
mstop	Stop a media channel
mswo	Codec switch over for an active call
mtime	Display media time statistics
mutex	Lists all created MXP mutexes
omms	Shows connection status to OMM(s)
otpdbCheck	Check all OTP pages for valid elements
queues	Lists all created MXP queues
reset	Resets the IPRFP application
resume	Resume bmc activity
sem	Lists all created MXP semaphores
signals	Print signal dwell time in queues
spy	Set/display spy levels: [ <key #> <level #> ]
suspend	Suspend bmc activity
tasks	Lists all running MXP tasks
tickres	Print tick resolution
timer	Print running timer
video	Video commands

**Please note:** The “spy” command enables you to increase the level of syslog messages. This should be only used by instructions of the support organization because it can harm the system operation.

### 8.3.5.5 OMM Console Commands

If you have opened the session on the OMM RFP and you type “ommconsole”, you are able to use the following OpenMobility Manager (OMM) related commands:

Command	Description
?	Displays Command Help Table
adb	Automatic DB export and import (ADB) console
axi	AXI commands
axic	Task console for AXI command processing of provisioning files

<b>Command</b>	<b>Description</b>
cert	Certificate import console
cmi	CMI commands
cnf	Show configuration parameters
cron	Display pending cron jobs
help	Displays Command Help Table
logger	Send a string to the syslog daemon
deftrc	Resets all trace settings to default
dlc	DECT Data Link Control
dm	Download Over Air Manager
dsip	DSIP commands
epr	External provisioning task (EPR) console and dynamic users console
runtime	Report the process runtime
mem	Show memory and heap
exit	Leave this console
gmi	DECTnet2 Inter Working Unit
hcm	Handset configuration management task (HCM) console
heartbeat	Configure heartbeat mechanism for IP-RFPs
ima	IMA commands
inspect	Display information of a user
ipc	Display socket communication
ipl	Display connected RFPs
iplfilter	Configure which RFPs spy messages are generated for
lic	LIC commands
loc	Info about locating extension
mon	Toggle monitor functionality
msm	Display states within MediaStreamManagement
msmtrc	Display / modify list of traced DECT phoneNs
mutex	List all created MXP mutexes
nwk	DECT network layer
prov	Prov-related commands
queues	List all created MXP queues
rcmd	Remote command on RFPs shell
rfp	Radio Fixed Part Control
rfpd	Radio Fixed Part Debug
rfps	Radio Fixed Part Statistic

Command	Description
rping	Request one or more RFPs to ping a host
rspy	Remote configure spy levels on IP-RFPs
rsx	Toggle RSX debug port on RFPs
rtt	Set event flag for high RTT values / clear values
sem	List all created MXP semaphores
spy	Set/display spy levels: [ <key #> <level #> ]
standby	Displays redundant OMMs
stat	Statistic
sync	Commands for RFP synchronization
sysdump	Initiate system dump
tasks	List all running MXP tasks
tickres	Print tick resolution
trc	Back trace task
tzone	Time zone commands
uds	UDS commands
umo	UMO commands
upd	Display update status of RFPs
update	Force all connected RFPs to search for new software
uptime	Display OpenMobility Manager uptime
ver	Version information
video	Command for video devices
wlan	Display states within Wireless LAN Management
xml	XML browser task (XML) console
xsc	XSC commands

**Please note:** The “spy” command enables you to increase the level of syslog messages especially for subsystems of the OMM. This should be only used by instructions of the support organization because it can harm the system operation.

### 8.3.6 CORE FILE CAPTURING

Fatal software problems may result in memory dumps, so called core files. These core files are helpful in analyzing the problem that caused the abnormal termination of the program. The IP RFP is capable of transferring the core files to a remote fileserver. Without any special configuration the files are transferred to the TFTP server that is used to get the system software. The path used is the directory of



the boot image. These two configuration items are retrieved from DHCP or via local configuration using the OM Configurator.

You can configure the URL to a writable directory via the OMM (see section 5.4.1.12) or through the “OM\_CoreFileSrvUrl” variable in the ipdect.cfg configuration files.

**Please note:** The server must allow writing new files (not typically enabled by default).

### 8.3.7 DECT MONITOR

**Please note:** The DECT Monitor has been replaced by OMP but the DECT Monitor can still be used without warranty for SIP-DECT installations with a standard PARK and up to 256 RFPs all within paging area 0.

For better error detection in the SIP-DECT system the DECT Monitor can be used. The DECT Monitor is an MS Windows based stand-alone program. It provides the possibility to give a real-time overview of the current IP DECT base station and telephone states in the SIP-DECT system.

The following features are provided by the DECT Monitor:

- Reading out of the DECT configuration of an SIP-DECT system.
- Configuration can be stored in an ASCII file.
- Display of DECT transactions IP DECT base station <-> telephone in clear tabular form with highlighting of handover situations. Real-time display.
- Display of further events concerning the status or actions of IP DECT base stations and telephones of the SIP-DECT system.
- All events can also be recorded in a log file.
- Display of the synchronization relations between the RFPs.
- Monitoring of systems with up to 256 IP DECT base stations and 512 DECT phones.
- Reading out and display of IP DECT RFP statistics data, either for a single IP DECT RFP or for all IP DECT RFPs.
- Display of DECT central data of the SIP-DECT system.

The DECT Monitor program can only be used when the **DECT monitor** checkbox is activated on the flag in the OMM **System settings** web page.

**Please note:** Because of security, the DECT monitor flag is not stored permanently in the internal flash memory of the OMM/RFP. After a reset the DECT monitor flag is disabled.

The DECT monitor program is used together with the SIP-DECT system. When the program is started, the user is requested to enter the IP address of the IP DECT RFP or the server running the OpenMobility Manager (OMM) software.

There can be several reasons for an unsuccessful link establishment:

- Operation of DECT monitor is not enabled inside the OMM. Use the OMM web service to enable DECT monitor operation.
- IP address is not correct. It must be the address of the RFP the OMM is running on.

- A link routed to the RFP is not supported.

The program displays the IP address which was used last time. When the program is started, a link to the OMM is automatically established and the program window shows all user configured child windows and tables. When all links have been established, the DECT data of the system are automatically read out and entered in the tables “RFP-Table” and “DECT phone-Table”. This procedure is called “Config Request”.

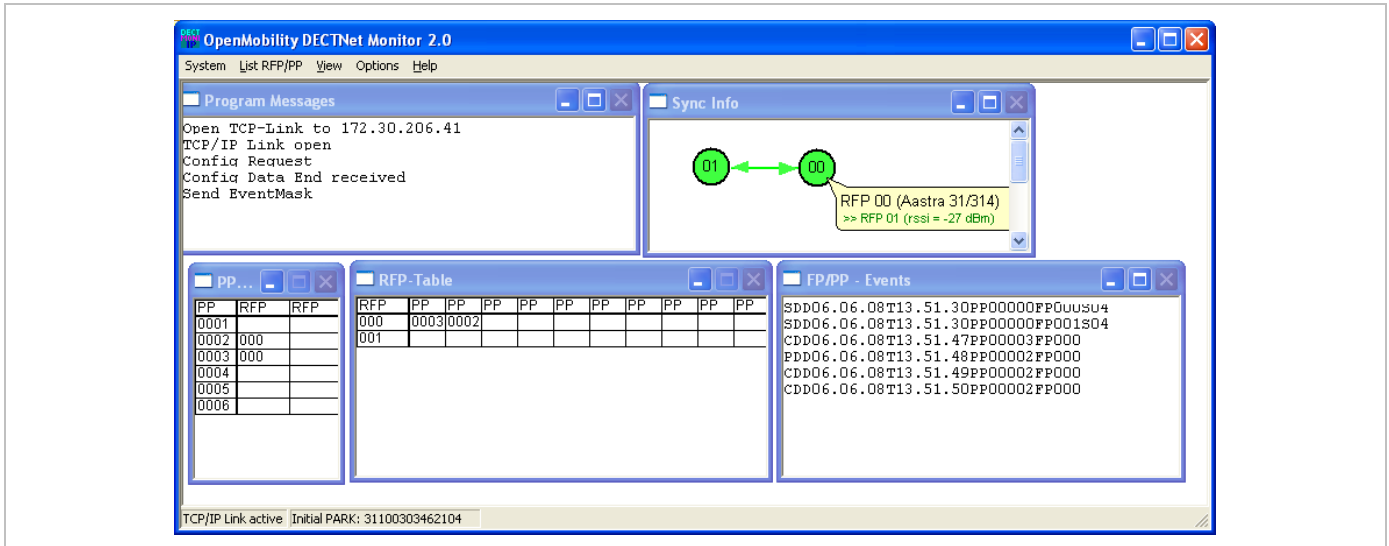

Next, the defined trace options (Event Mask) are sent to the OMM. The options which are sent to the OMM are always those which were active the last time the program was exited.

If the trace option “Transaction establish/release” is activated, the OMM will deliver all existing transactions.

Following this, the OMM system delivers the desired trace data. The user can either communicate with the program interactively (see below) or he can simply activate a log file in which to record the data.

Following this initialization, the user can carry out the following modifications:

- The trace settings can be modified using the menu item **Options-Event Mask**. Transmission to the OMM takes place after confirmation of the settings with **OK**.
- A Config Request can be sent again to the OMM.
- A log file can be activated.
- By means of various dialogs, the configuration data of the telephones, RFPs and control modules can be displayed and stored in ASCII files.

The following information is displayed dynamically in the tables:

- Transactions between telephone and DECT system. These are displayed in both tables. Simple transactions are displayed in black on a white background; during handover, both transactions involved are displayed in white on a red background.
- The Location Registration and Detach events are displayed in the tables for approx. 1-2s after their occurrence (light green background), if possible. There is no display in the FP table if there is no column free for display. If the event has already been displayed, it can be overwritten at any time. The events are not displayed if they occur during an on-going transaction. Irrelevant of whether the events are displayed in the tables, they are always entered in the **FP/DECT phone-Events** window and in the log file (provided that this is open).

The following color scheme is used for display of the RFPs in the RFP table:

- RFP gray-blue: IP DECT base station is not active (not connected or disturbance).
- RFP black: IP DECT base station is active.

The data of an RFP are displayed in a dialogue box after clicking on the respective RFP field in the RFP table. The statistics data of the RFP can be called up from this dialogue box.

The following color scheme is used for display of the telephone in the DECT phone table:

- DECT phone black: Handset is enrolled. It is assumed that the telephone can be reached.
- DECT phone blue: Handset can presumably not be reached. Detach was received, or when an attempt was made to reach a telephone, the DECT phone did not answer.
- DECT phone gray blue: Handset not enrolled.

The data of a telephone are displayed in a dialog box after clicking on the respective telephone field in the FP table.

The **Sync Info** child window contains all IP DECT base stations and shows their synchronization and relation states to each other. Selecting the IP DECT base stations with the right mouse button, the user can change visibility views and can even force a resynchronization of an IP DECT base station.

There are several optional child windows selectable. They are all listed below and give some more information about the SIP-DECT systems. Mostly they are statistics and for internal use only.

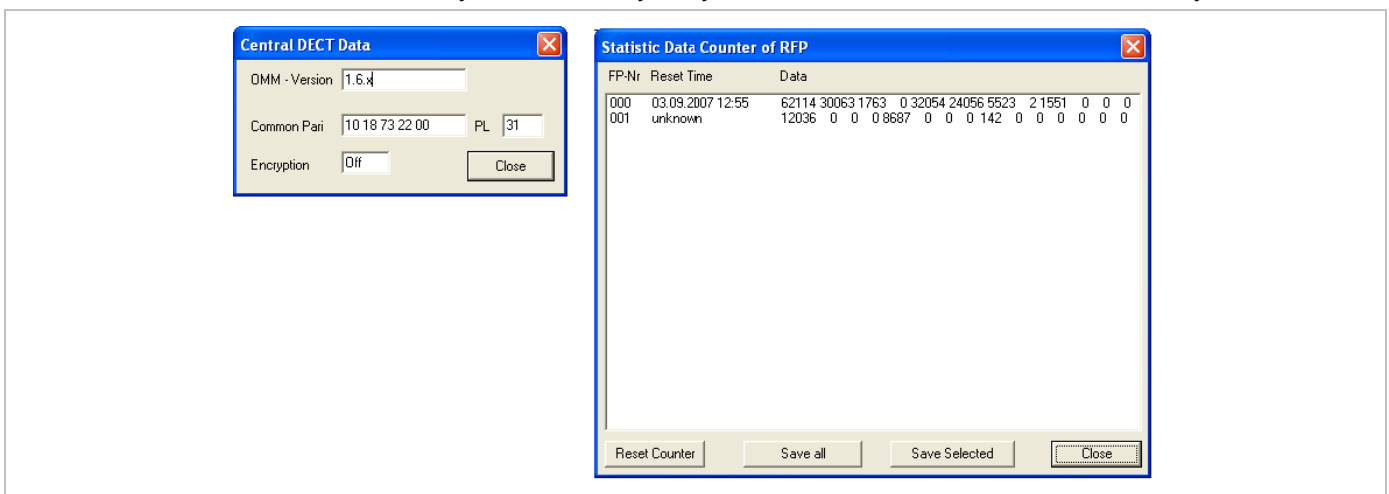

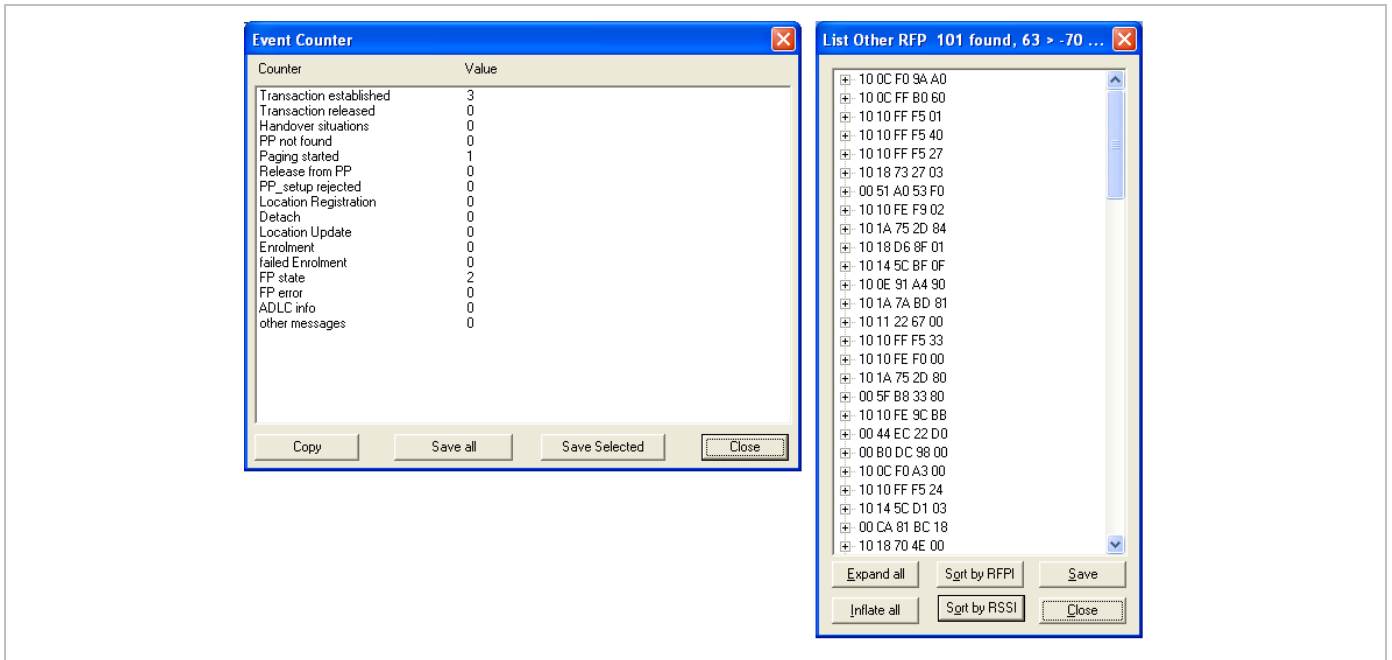

## 9 SAFETY INFORMATION

### 9.1 CE MARKING

This certifies the conformity of the product with the regulations which apply in accordance with the directive R&TTE 1999/5/EC.

For a copy of the original signed declaration (in full conformance with EN45014) please contact the Regulatory Approvals Manager at Mitel Networks Ltd., Castlegate Business Park, Portskewett, Monmouthshire, NP26 5YR, United Kingdom.

### 9.2 COMMUNICATIONS REGULATION INFORMATION

The regulation information in this section applies to the following supported DECT base stations:

- RFP 32 IP
- RFP 34 IP
- RFP 35 IP
- RFP 36 IP
- RFP 37 DRC

#### 9.2.1 FCC NOTICES (U.S. ONLY)

This device complies with part 15 of the FCC Rules. Operation is subject to the following two conditions: (1) This device may not cause harmful interference, and (2) this device must accept any interference received, including interference that may cause undesired operation.

Modifications not expressly approved by this company could void the user's authority to operate the equipment.

**NOTE:** This equipment has been tested and found to comply with the limits for a Class B digital device, pursuant to Part 15 of the FCC Rules. These limits are designed to provide reasonable protection against harmful interference in a residential installation. This equipment generates, uses and can radiate radio frequency energy and, if not installed and used in accordance with the instructions, may cause harmful interference to radio communications. However, there is no guarantee that interference will not occur in a particular installation. If this equipment does cause harmful interference to radio or television reception, which can be determined by turning the equipment off and on, the user is encouraged to try to correct the interference by one or more of the following measures:

- Reorient or relocate the receiving antenna.
- Increase the separation between the equipment and receiver.
- Connect the equipment into an outlet on a circuit different from that to which the receiver is connected.
- Consult the dealer or an experienced radio/TV technician for help.

## 9.3 HEALTH AND SAFETY

### 9.3.1 EXPOSURE TO RADIO FREQUENCY (RF) SIGNALS:

The wireless phone is a radio transmitter and receiver. It is designed and manufactured not to exceed the emission limits for exposure to radio frequency (RF) energy set by the Federal Communications Commission (FCC) of the U.S. Government. These limits are part of comprehensive guidelines and establish permitted levels of RF energy for the general population. The guidelines are based on the safety standards previously set by both U.S. and international standards bodies. These standards include a substantial safety margin designed to assure the safety of all persons, regardless of age and health.

This device and its antenna must not be co-located or operating in conjunction with any other antenna or transmitter.

The radiating element of the RFP should be installed during operating at a separation distance greater than 20 cm between user and device. The device complies with the requirements for routine evaluation limits.

### 9.3.2 INDUSTRY CANADA (CANADA ONLY)

Operation of this device is subject to the following two conditions: (1) this device may not cause interference, and (2) this device must accept any interference, including interference that may cause undesired operation of the device.

Privacy of communications may not be ensured when using this telephone.

#### **Exposure to Radio Frequency (RF) Signals:**

The wireless phone is a radio transmitter and receiver. It is designed and manufactured not to exceed the emission limit for exposure to radio frequency (RF) energy set by the Ministry of Health (Canada), Safety Code 6. These limits are part of comprehensive guidelines and established permitted levels of RF energy for the general population. These guidelines are based on the safety standards previously set by international standard bodies. These standards include a substantial safety margin designed to assure the safety of all persons, regardless of age and health.

This device and its antenna must not be co-located or operating in conjunction with any other antenna or transmitter.

The radiating element of the RFP should be installed during operating at a separation distance greater than 20 cm between user and device. This device complies with the requirements for routine evaluation limits.

## 9.4 INFORMATIONS RÉGLEMENTAIRES EN MATIÈRE DE COMMUNICATIONS

Les informations dans cette section concerne les suivantes stations radio :

- RFP 32 IP
- RFP 34 IP
- RFP 35 IP
- RFP 36 IP
- RFP 37 DRC

### 9.4.1 NOTES FCC (USA UNIQUEMENT)

Cet appareil est conforme à la partie 15 des règles FCC. Son exploitation est soumise aux deux conditions suivantes: (1) Cet appareil ne doit causer aucune interférence dommageable et (2) cet appareil doit tolérer toute interférence reçue à l'inclusion des interférences susceptibles de causer une opération non désirée. Les modifications non expressément agréées par cette entreprise pourraient rendre caduque l'habilitation de l'utilisateur à exploiter cet équipement.

**NOTA:** Cet équipement a été testé et jugé conforme aux limitations pour un appareil numérique de classe B en vertu de la partie 15 des règles FCC. Ces limitations ont été conçues pour garantir une protection raisonnable contre les interférences dommageables dans les installations résidentielles. Cet équipement génère, utilise et peut rayonner des ondes radio et peut causer des interférences dommageables dans les communications par radio s'il n'est pas installé et utilisé conformément aux instructions. Cependant, l'absence d'interférences dans une installation particulière n'est pas garantie. Si cet équipement perturbe de façon importante la réception de la radio ou de la télévision (interférences qui peuvent être déterminées en arrêtant et en remettant l'appareil en marche), l'utilisateur est invité à tenter de corriger les interférences en prenant une ou plusieurs des mesures suivantes:

- Réorienter ou déplacer l'antenne de réception.
- Éloigner l'équipement du récepteur.
- Raccorder l'équipement à une prise d'un circuit différent de celui auquel est raccordé le récepteur.
- Consulter le revendeur ou un technicien radio/TV.

## 9.5 SANTÉ ET SÉCURITÉ

### 9.5.1 EXPOSITION AUX SIGNAUX RADIO (RF)

Votre téléphone sans fil est un émetteur-récepteur radio. Il a été conçu pour ne pas dépasser les limitations en matière d'exposition aux ondes radio établies par la Federal Communications Commission (FCC) du gouvernement des États-Unis. Ces limitations font partie de directives complètes et établissent des niveaux admissibles d'énergie RF pour l'ensemble de la population. Ces directives sont basées sur des normes de sécurité établies par des organes de normalisation américains et internationaux. Ces normes intègrent une importante marge de sécurité censée garantir la sécurité de toute personne, quels que soient son âge et son état de santé.

Cet appareil et son antenne ne doivent pas être installés ou exploités conjointement avec d'autres antennes ou émetteurs.

L'élément rayonnant de la station radio doit être installé à une distance de 20 cm ou plus entre l'utilisateur et l'appareil. Cet appareil est conforme aux exigences relatives aux limites d'évaluation de routine .

### 9.5.2 INDUSTRIE CANADA (CANADA UNIQUEMENT)

L'exploitation de cet appareil est soumise aux deux conditions suivantes: (1) Cet appareil ne doit causer aucune interférence et (2) cet appareil doit tolérer toute interférence reçue à l'inclusion des interférences susceptibles de causer une opération non désirée.

La confidentialité des communications risque de ne pas être garantie lorsque vous utilisez ce téléphone.

**Exposition aux ondes radio (RF):**

Votre téléphone sans fil est un émetteur-récepteur radio. Il a été conçu pour ne pas dépasser les limitations en matière d'exposition aux ondes radio émises par le Ministère de la Santé (Canada,) Code de sécurité 6. Ces limitations font partie de directives complètes et établissent des niveaux admissibles d'énergie RF pour l'ensemble de la population. Ces directives sont basées sur des normes de sécurité établies par des organes de normalisation internationaux.

Ces normes intègrent une importante marge de sécurité censée garantir la sécurité de toute personne, quels que soient son âge et son état de santé.

Cet appareil et son antenne ne doivent pas être installés ou exploités conjointement avec d'autres antennes ou émetteurs.

L'élément rayonnant de la station radio doit être installé à une distance de 20 cm ou plus entre l'utilisateur et l'appareil. Cet appareil est conforme aux exigences relatives aux limites d'évaluation de routine .



# 10 APPENDIX

This Appendix contains additional information and examples for configuring your SIP-DECT system.

## 10.1 PRE-CONFIGURATION FILE RULES

The following file format description can be used to administrate the RFP and DECT phone configuration with external applications, e.g. an external configuration management tool or a PBX communications system.

The framework of the text file follows strictly defined rules. The main framework is divided in two parts:

- 1 An **instruction section** is used to drive a generic data creation for those fields not filled within data sequence section.
- 2 A data sequence section defines data record fields. Each of them is explicitly set.

Layout rules in detail are:

- Comments start with “#”.
- Each record is terminated by the regular expressions “\r” or “\n”.
- Instruction settings are made like: <tag> = <value>.
- Data sequence sections start with the key word “data\_sequence”. This key word is **mandatory** for file processing to proceed. All instructions must be written before this row.
- Data sequence record fields are separated by colon “;”. Colons have also to be set for empty fields if at least one follows which is not empty. Otherwise a position mismatch of fields will occur.
- If fields have several values assigned (that may be true for a few local RFP configuration fields like “ntp\_address”), they must be separated by comma “,”.

### Notes:

- Because data sequence fields are separated by a colon, the content of that section can be generated by a \*.csv export of Excel Sheet and copied into the configuration file.
- Instructions are only processed on those fields that are left empty within the data sequence section.

### 10.1.1 DECT PHONE CONFIGURATION FILE (OMM DATABASE)

#### 10.1.1.1 Supported Instructions

Instruction	Explanation
start_number	Numbers can be generated automatically. This instruction defines the start value.
no_of_number	If “start_number” is given, this instruction defines the maximum of numbers which are generated.
ac (authentication code)	If set to “number”, “ac” will be equal to number. If a value is advised, it will be taken as a start number which will be increased for each new record.
additional_pin	
sip_user	
sip_pw	
sos_number	If these instructions are set, the value will be taken as default

mandown_number	value for the empty corresponding field within the data sequence section records. SOS/Mandown denote the user specific numbers. The Locatable, Localization, and Tracking flags are ignored by Web import.
locatable	
localization	
tracking	

### 10.1.1.2 Data Section Fields

The data section contains the following field order:

- 1 Number
- 2 Name
- 3 AC
- 4 IPEI
- 5 Additional ID
- 6 Sip user name
- 7 Sip password
- 8 SOS number
- 9 Mandown number
- 10 Locatable (ignored by Web import and always set to "inactive")
- 11 Localization (ignored by Web import and always set to "inactive")
- 12 Tracking (ignored by Web import and always set to "inactive")
- 13 Description1 (ignored by Web import and always set to "")
- 14 Description2 (ignored by Web import and always set to "")

### 10.1.1.3 Example

The following screen shot shows a DECT phone configuration. This corresponds to the given configuration file.

The screenshot shows a web interface for DECT phone configuration. On the left is a navigation menu with items: Sites, Radio fixed parts, Portable parts, WLAN, System features, Licenses, and Info. The main content area has a search bar with 'Durchsuchen...' and buttons for 'Import' and 'Log file'. Below this is the 'Enrolment data' section with 'Add', 'Delete', and 'Log file' buttons. The primary section is titled '12 Portable parts' and contains a table with the following data:

<input type="checkbox"/>	Name	Number/SIP user name	IPEI	DECT authentication code	Additional ID
<input type="checkbox"/>	PP 1	101	0081008625768	1001	101
<input type="checkbox"/>	PP 4	104	0007701154842	1002	104
<input type="checkbox"/>	Kiel Phone1	5401	0127105395099	1003	5401
<input type="checkbox"/>	Karl May	5402	-	1004	5402
<input type="checkbox"/>	Karl Valentin	5403	-	1005	5403
<input type="checkbox"/>	Karl Heinz	5404	-	1006	5404
<input type="checkbox"/>	Radi Radenkowicz	5405	-	1007	5405
<input type="checkbox"/>	Radi Rettich	5406	-	1008	5406
<input type="checkbox"/>	Wadi Wade	5407	-	1009	5407
<input type="checkbox"/>	-	5408	-	1010	5408
<input type="checkbox"/>	-	5409	-	1011	5409
<input type="checkbox"/>	-	5410	-	1012	5410

**DECT phone configuration file:**

```
# -----#
# instruction section:
# -----#
# -- start_number    = {<start value for numbers to be generated>}
# -- no_of_number    = {<maximum of generated numbers>}
# -- ac              = {<"number">, <start value for ac's to be generated>}
# -- additional_pin  = {<"number">, <start value for id's >}
# -- sip_user        = {<"number">, <start value for id's >}
# -- SIP password    = {<"number">, <start value for id's >}
# -- SOS number      = {<common default>}
# -- Mandown number
# -- Locatable (ignored by Web import and always set to inactive)
# -- Localization (ignored by Web import and always set to inactive)
# -- Tracking (ignored by Web import and always set to inactive)

start_number = 5401
no_of_number = 10
ac = 1001
additional_pin = number
sip_user = number
sip_pw = number
sos_number=5002
mandown_number=5002

# -----#
# data sequence:
# -----#
# 1. number
# 2. name
# 3. AC
# 4. IPEI
# 5. additionalId
# 6. SIP user
# 7. SIP password
# 8. sos no
# 9. mandown no
# 10. locatable (ignored by Web import and always set to inactive)
# 11. localization (ignored by Web import and always set to inactive)
# 12. tracking (ignored by Web import and always set to inactive)
# 13. descr1 (ignored by Web import and always set to "")
# 14. descr2 (ignored by Web import and always set to "")
```

```
data_sequence;;;;;;;;;;;;;
# 1. number;2. name;3. AC;4. IPEI ;5. additionalId;6. SIP user;7. SIP password;8. sos
no;9. mandown no;10. locatable;11. localization;12. tracking;13. descr1;14. descr2
101;DECT phone 1;;0081008625768;;;;;;;;;;;;;
104;DECT phone 4;;0007701154842;;;;;;;;;;;;;
;Kiel Phone1;;0127105395099;5401;5401;5401;30;30;;;;;
;Karl May;;;;;;;;;;;;;
;Karl Valentin;;;;;;;;;;;;;
;Karl Heinz;;;;;;;;;;;;;
;Radi Radenkowicz;;;;;;;;;;;;;
;Radi Rettich;;;;;;;;;;;;;
;Wadi Wade;;;;;;;;;;;;;
```

### Parse log about import / instruction processing

```
OK: start_number = 5401
OK: ac = 1001
OK: additional_pin = number
OK: sip_user = number
OK: sip_pw = number
OK: sos_number = 5002
OK: mandown_number = 5002

OK: no_of_number = 10

Section processing:
```

[...]

## 10.2 RFP CONFIGURATION FILE / CENTRAL (OMM DATABASE)

You can import of DECT base station configurations using files via the OMP.

### 10.2.1.1 Supported Instructions

All instructions are taken as a common value and are applied to all records in the data sequence section of that file if the corresponding field is empty.

Instruction	Explanation
active	Activation of DECT: {'0' or 'false '= inactive, '1' or 'true' = active }
cluster	Cluster, the RFP is referred to - RFP-OMM: {1..256}, PC-OMM: {1..4096}
paging_area	Paging area, the RFP is referred to: {'unassigned, '0'..'127'} Ignored by WEB import and always set to '0' (Paging area 0)
sync_source	Synchronization source: {'0' or 'false '= inactive, '1' or 'true' = active }
refl_env	Reflective environment: {'0' or 'false '= no, '1' or 'true' = yes }
site	Site Id: {1..250}
wlan_profile	Reference key to an existing WLAN profile
wlan_antenna	Antenna settings: {0=diversity, 1, 2}
wlan_channel_bg	WLAN channel: {0..14 (size depends on regulatory domain) }
wlan_power	WLAN power: {6, 12, 25, 50,100 (in percent)}
wlan_act	Activation of WLAN: {'0' or 'false '= inactive, '1' or 'true' = active }

### 10.2.1.2 Data Section Fields

The data section contains the following field order:

- 1 MAC address
- 2 Name
- 3 DECT activated
- 4 DECT cluster
- 5 Paging area (always set to "0", PA0)
- 6 Preferred sync.
- 7 Reflective env.
- 8 Site ID (if left empty then set to the lowest Site ID)
- 9 Building (ignored by Web import and always set to "")
- 10 Floor (ignored by Web import and always set to "")
- 11 Room (ignored by Web import and always set to "")
- 12 WLAN profile
- 13 WLAN antenna
- 14 WLAN channel
- 15 WLAN power
- 16 WLAN activated

### 10.2.1.3 Example

The following figure shows the results of a DECT base station enrolment operation via the OMP DECT base stations -> Enrolment page.

Select RFP enrolment import file

File

Show log file

	MAC address	Name	DECT cluster	Paging area	Site ID	HW type	Status	
<input type="checkbox"/>	00:30:42:0D:97:1A	R451P31a03054	1	0	1	Auto	⌘	
<input type="checkbox"/>	00:30:42:0D:95:D8	R439 SWT 31A-0-3-1-2	1	0	1	Auto	⌘	
<input type="checkbox"/>	00:30:42:0C:8D:78	R440 P31a-03-07-4	1	0	3	Auto	⌘	
<input type="checkbox"/>	00:30:42:0D:95:CE	Patchschrank Kueche	1	0	3	Auto	⌘	
<input type="checkbox"/>	00:30:42:0D:95:CC	R414 OpenMob lab	2	0	3	Auto	⌘	
<input type="checkbox"/>	00:30:42:0D:95:CA	R414 OpenMob lab	2	0	3	Auto	⌘	
<input type="checkbox"/>	00:30:42:0C:8D:DD	R403 System test lab	2	0	3	Auto	⌘	
<input type="checkbox"/>	00:30:42:0D:95:D8	R451 P31a-4-2-15-8	1	0	1	Auto	⌘	
<input type="checkbox"/>	00:30:42:0D:95:D9	R439 P31a-4-2-12-13	1	0	3	Auto	⌘	
<input type="checkbox"/>	00:30:42:0D:95:D6	R447 P31a-4-2-13-18	1	0	3	Auto	⌘	
<input type="checkbox"/>	00:30:42:0D:95:E7	R447 P31a-4-2-14-13	1	0	1	Auto	⌘	
<input type="checkbox"/>	00:30:42:0D:22:5A	R433 P31a-4-2-11-10	1	0	3	Auto	⌘	
<input type="checkbox"/>	00:30:42:0C:8D:68	R433 P31a-4-2-11-13	1	0	1	Auto	⌘	
<input type="checkbox"/>	00:30:42:08:92:FC	R443 Test board	1	0	1	Auto	⌘	
<input type="checkbox"/>	00:30:42:FF:F0:D0	plexiglas	1	0	1	Auto	⌘	
<input type="checkbox"/>	00:30:42:0D:27:7D	R434 P31M-0-1-5-19	1	0	3	Auto	⌘	
<input type="checkbox"/>	00:30:42:0A:C9:62	R439 Decke re.	1	0	1	Auto	⌘	
<input type="checkbox"/>	00:30:42:0D:E3:F6	R436 Wand oben In	1	0	1	Auto	⌘	
<input type="checkbox"/>	00:30:42:08:31:5F	R434 Decke In, Tür	1	0	1	Auto	⌘	
<input type="checkbox"/>	00:30:42:08:31:64	R440 Decke re Fnstr	1	0	1	Auto	⌘	

⌘

Add all

Add selected

Remove all

Remove selected

Show status

Select columns

### RFP configuration file/central:

```
#####
# instruction section:
#####
#active
#
#           Activation of DECT:
#           {'0' or 'false '= inactive, '1' or 'true' = active}
#cluster
#
#           Cluster, the RFP is referred to:
#           {1..256} (RFP OMM) or {1..4096} (PC OMM)
#paging_area
#
#           Ignored by Web import and always set to "0" (PA0)
#           Paging area, the RFP is referred to: {'unassigned', '0'..'127'}
#sync_source
#
#           Synchronisation source:
#           '0' or 'false '= inactive, '1' or 'true' = active}
#refl_env
#
#           Reflective environment:
#           '0' or 'false '= no, '1' or 'true' = yes}
#site
#
#           Site Id: {1..250}
#wlan_profile
#
#           Reference key to an existing WLAN profile
#wlan_antenna
#
#           Antenna settings: {0=diversity, 1, 2}
```

```

#wlan_channel_bg
#           WLAN channel: {0..14 (size depends on regulatory domain) }
#wlan_power
#           WLAN power = { 6, 12, 25, 50,100 (in percent)}
#wlan_act
#           Activation of WLAN:
#           '0' or 'false '= inactive, '1' or 'true' = active}
#Note: Web import allows only "0" or "1" for Boolean
#####

active=1
cluster=100
refl_evc=1
site=1

#####
data_sequence
#####
#MAC address;Name;DECT activated;DECT cluster;Paging area;Preferred sync.;
#Reflective env.;Site ID;Building;Floor;Room;WLAN profile;WLAN antenna;
#WLAN channel;WLAN power;WLAN activated
00:30:42:0D:97:1A;R451P31a03054;1;1;0;0;0;1;31;4;;;
00:30:42:0D:95:D8;R439 SWT 31A-0-3-1-2;1;1;0;1;0;1;31;4;;;
00:30:42:0C:BD:7B;R440 P31a-03-07-4;1;1;0;0;0;3;31;4
00:30:42:0D:95:CE;Patcheschrank Kueche;1;1;0;0;0;3;31;4
00:30:42:0D:95:CC;R414 OpenMob lab;1;2;0;0;0;3;;
00:30:42:0D:95:CA;R414 OpenMob lab;1;2;0;0;0;3;31;4
00:30:42:0C:BD:DD;R403 System test lab;1;2;0;0;0;3;31;4
00:30:42:0D:95:DB;R451 P31a-4-2-15-8;1;1;0;0;0;1;31;4
00:30:42:0D:95:D9;R439 P31a-4-2-12-13;1;1;0;0;0;3;31;4
00:30:42:0D:95:D6;R447 P31a-4-2-13-18;1;1;0;0;0;3;31;4
00:30:42:0D:95:E7;R447 P31a-4-2-14-13;1;1;0;0;0;1;31;4
00:30:42:0D:22:5A;R433 P31a-4-2-11-10;1;1;0;0;0;3;31;4
00:30:42:0C:BD:68;R433 P31a-4-2-11-13;1;1;0;0;0;1;31;4
00:30:42:0B:92:FC;R443 Test board;1;1;0;0;0;1;31;4
00:30:42:FF:F0:D0;plexiglas;1;1;0;0;0;1;;
00:30:42:0D:27:7D;R434 P31M-0-1-5-19;1;1;0;0;0;3;31;4
00:30:42:0A:C9:62;R439 Decke re.;1;1;0;0;0;1;;
00:30:42:0D:E3:F6;R436 Wand oben ln;1;1;0;0;0;1;;
00:30:42:08:31:5F;R434 Decke ln. Tür;1;1;0;0;0;1
00:30:42:08:31:64;R440 Decke re Fnstr;1;1;0;0;0;1

```

## Parse log about import / instruction processing

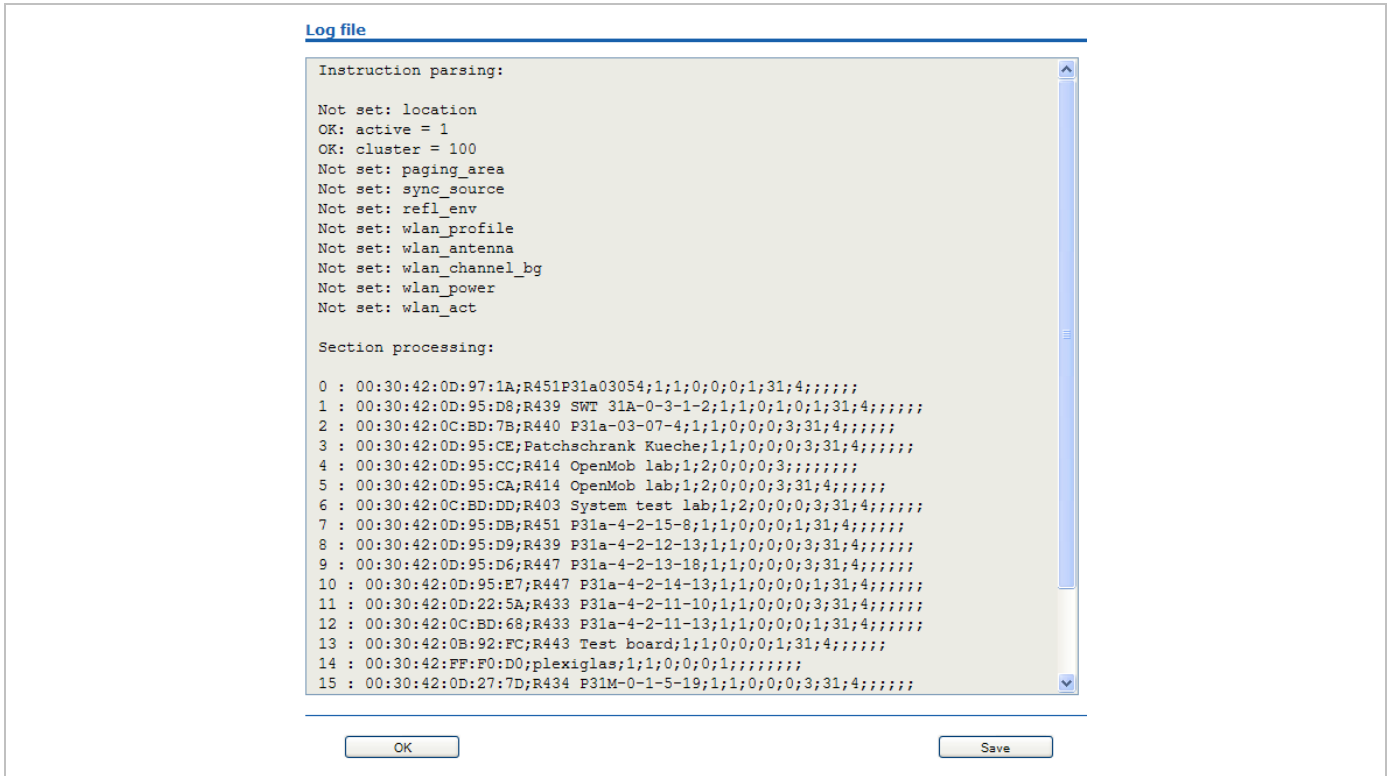

## 10.2.2 RFP CONFIGURATION FILE / LOCAL (OM CONFIGURATOR)

## 10.2.2.1 Supported Instructions

All instructions are taken as a common value and are applied to all records in the data sequence section of that file if the corresponding field is empty.

Instruction	Explanation
active	Local configuration active: {0=inactive(use DHCP instead), 1=active}
net_mask	Net mask
tftp_server	IP address of TFTP server
tftp_file	Path and name of boot file
omm_1	OMM IP address
omm_2	IP address of backup OMM
gateway	Default gateway
dns_server	Up to two DNS server IP addresses
dns_domain	local DNS domain
syslog_addr	IP address of syslog daemon
syslog_port	Listen port of syslog daemon
use_vlan	VLAN is enabled



Instruction	Explanation
srvlst	List of further tftp server
broadcast_addr	local broadcast address
vlan_id	VLAN Id
preferred_tftp	tftp_server is preferred
config_file_server	configuration server

### 10.2.2.2 Data Section Fields

The data section contains the following field order:

- 1 MAC address of RFP
- 2 Local configuration active flag
- 3 IP address of RFP
- 4 Net mask
- 5 TFTP server
- 6 TFTP\_FILE
- 7 OMM IP address
- 8 IP address of backup OMM
- 9 Default gateway
- 10 DNS server
- 11 DNS domain
- 12 Syslog daemon IP address
- 13 Syslog listen port
- 14 Use VLAN
- 15 Server list
- 16 Broadcast address
- 17 VLAN Id
- 18 Preferred TFTP server
- 19 Configuration file server

### 10.2.2.3 Example

**RFP configuration file/local (OM Configurator):**

```
# -----#
# instruction section #
# -----#

active      = 1
net_mask    = 255.255.0.0
tftp_server= 172.30.200.92
tftp_file   = iprfp2G.tftp
```

```
omm_1      = 172.30.111.188
omm_2      = 172.30.11.181
gateway    = 172.30.0.2
dns_server = 172.30.0.4,172.30.0.21
dns_domain = aastra.de
syslog_addr= 172.30.200.92
use_vlan   = 1
srvlist    = 172.30.0.4,172.30.0.21
broadcast_addr = 172.30.255.255
vlan_id    = 4
preferred_tftp = 1
config_file_server = https://server/configfiles/
```

```
# -----#
# data sequence #
# -----#
# 1. MAC_ADDR           ! no instruction supported !
# 2. ACTIVE_FLAG
# 3. RFPADDR           ! no instruction supported !
# 4. NET_MASK
# 5. TFTP_SERVER
# 6. TFTP_FILE
# 7. OMM1
# 8. OMM2
# 9. GATEWAY
#10. DNS_SERVER
#11. DNS_DOMAIN
#12. SYSLOG_ADDR
#13. SYSLOG_PORT
#14. USE_VLAN
#15. SRVLIST
#16. BROADCAST_ADDR
#17. VLAN_ID
#18. PREFERRED_TFTP
#19. CONFIG_FILE_SERVER
```

```
data_sequence
00-30-42-01-01-01;;172.30.111.1
00-30-42-02-02-02;;172.30.111.2
```

---

**Parse log for import / instruction processing**

```
ok: active = 1
ok: net_mask = 255.255.0.0
ok: tftp_server = 172.30.200.92
ok: tftp_file = iprftp2G.tftp
ok: omm_1 = 172.30.111.188
ok: omm_2 = 172.30.11.181
ok: gateway = 172.30.0.2
ok: dns_server = 172.30.0.4,172.30.0.21
ok: dns_domain = mitel.com
ok: syslog_addr = 172.30.200.92
not set: syslog_port
ok: use_vlan = 1
ok: srvlist = 172.30.0.4,172.30.0.21
ok: broadcast_addr = 172.30.255.255
ok: vlan_id = 4
ok: preferred_tftp = 1
ok: config_file_server = https://server/configfiles/
```

```
:parsing ok:
```

```
processing of section: data_sequence
```

```
[...]
```

```
create data:
```

```
[...]
```

```
RFP configuration:
```

```
[...]
```

## 10.3 RFP EXPORT FILE FORMAT

### General

RFP export files are created by OMM Management Portal in 'csv'-file format which can be easily viewed by a spreadsheet application. Export file contains all or a part of the following parameters:

- MAC address
- Location name
- DECT active
- Cluster
- Paging area
- Synchronization source
- Reflective environment
- Site
- Building
- Floor
- Room
- WLAN profile reference
- WLAN antenna
- WLAN Channel\_bg
- WLAN power
- WLAN active

### Example

Following example RFP export file contains all exportable RFP parameters and is re-importable by OMM Management Portal.

```
#####  
# RFP data export file: '/home/user/example.csv'  
# Date: 24.09.10 Time: 15:58:19  
#####  
#  
# Exported parameters:  
#  
# MAC address  
# Name  
# DECT activated  
# DECT cluster  
# Paging area  
# Preferred sync.  
# Reflective env.  
# Site ID  
# Building  
# Floor
```

```

# Room
# WLAN profile
# WLAN antenna
# WLAN channel
# WLAN power
# WLAN activated
#
#####

MAC address;Name;DECT activated;DECT cluster;Paging area;Preferred sync.;Reflective
env.;Site ID;Building;Floor;Room;WLAN profile;WLAN antenna;WLAN channel;WLAN power;WLAN
activated

data_sequence

00:30:42:0E:71:41;License RFP 1;
true;1;0;false;true;1;B1;F1;R1;1;0;;100;false

00:30:42:0E:26:F1;License RFP 2;
true;1;0;false;false;1;B1;F2;R1;1;0;;100;false

00:30:42:0E:75:59;License RFP 3;
true;1;0;true;false;1;B1;F2;R2;1;0;;100;false

```

## 10.4 COA CONFIGURATION PARAMETERS

In addition to the information provided in section 7.23, the following sections provide an example of a CoA configuration file, and an overview of all supported parameters.

### 10.4.1 EXTENDED COA EXAMPLE

```

UD_ConfigurationName = "omm-test" # name of the configuration file
### message options
UD_MessageMelodyNormal = basic_1
UD_MessageMelodyUrgent = basic_2
UD_MessageMelodyAlarm = basic_3

UD_MessageVolumeNormal = level_1
UD_MessageVolumeUrgent = level_2
UD_MessageVolumeAlarm = level_3

UD_MessageOverwrite = true

### ringer melody options

```

```
UD_RingerMelodyIntern = butterfly
UD_RingerMelodyExtern = barock
UD_RingerMelodyUnknown = ballade
UD_RingerMelodyCallback = fancy
UD_RingerMelodyRecall = comelody
UD_RingerMelodyVip = easy_groove
UD_RingerMelodySpecial = happy_fair
UD_RingerMelodyAlarm = kitafun
UD_RingerMelodyAppointment = latin_dance

### ringer volume options
UD_RingerVolumeIntern = off
UD_RingerVolumeExtern = increasing
UD_RingerVolumeUnknown = level_1
UD_RingerVolumeCallback = level_2
UD_RingerVolumeRecall = level_3
UD_RingerVolumeVip = level_4
UD_RingerVolumeSpecial = level_5
UD_RingerVolumeAlarm = level_6
UD_RingerVolumeAppointment = level_7

### ringer settings
UD_RingMode = repeat
UD_RingBuzz = true
UD_RingVibra = true
UD_RingHeadset = false

### attention tones
UD_ToneKey = inactive active
UD_ToneCnf = active
UD_ToneMnend = active no_speaker
UD_ToneAccu = active vibra
UD_ToneRange = inactive active no_speaker vibra
UD_ToneOutrange = inactive

### audio
UD_AudioNoisedetect = true
UD_AudioLoudenv = false
UD_AudioSpkCharger = handsfree

### Systems/Subscription/<System X>
UD_DialCharset = ABC_123
UD_DialCodeImax = 3
```

```
UD_DialCodeSys = "6"

### display
UD_DispLang=en
UD_DispFont=large
UD_DispColor=black

### illumination
UD_LightDim = 2h
UD_LightDisp = 2m
UD_LightKey = 45s
UD_LightKeyoptIncom = true
UD_LightKeyoptAlarm = false
UD_LightKeyoptCharge = false
UD_LightCharge = 60s
UD_LightCall = 30s
UD_LightMsgMsg = 10s
UD_LightMsgInf = 20s
UD_LightMsgJob = 30s
UD_LightMsgSos = 60s

### led indications
UD_LedAlive = true
UD_LedIncom = true
UD_LedRange = false
UD_LedCharge = true
UD_LedInfo = false
UD_LedSpk = true
UD_LedAppoint = false
UD_LedAlarm = false

### list access
UD_ListmodeRedial = pbx
UD_ListmodeCaller = pbx
UD_ListmodeFilter = block_list

### device options
UD_ModeSilentcharge = true
UD_ModeChargeranswr = false
UD_ModeAutoanswr = true
UD_ModeAutoquickhook = false
UD_ModeKey = oem
```

```
### phone lock
UD_LockKeyAuto = true
UD_LockKeyTime = 30s
UD_LockKeyPin = true
UD_LockPin = "1234"
UD_LockAdmin = "4711"

### SOS call
UD_SosNumber = "4711"
UD_SosMelody = weekend
UD_SosVolume = increasing
UD_SosHandsfree = true

### alarm sensor
UD_SosMdNumber = "0815"
UD_SosMdAutoanswr = true
UD_SosMdModePre = false
UD_SosMdModeDown = true
UD_SosMdModeNomove = true
UD_SosMdModeEsc = false
UD_SosMdModeRep = false
UD_SosMdSenseAngle = flat
UD_SosMdSenseMove = high
UD_SosMdSenseEsc = medium
UD_SosMdNomoDown = conversation system_menu local_menu
UD_SosMdNomoNomove = conversation
UD_SosMdNomoEsc = idle conversation system_menu local_menu
UD_SosMdDelayDown = 20s
UD_SosMdDelayNomove = 30s
UD_SosMdDelayEsc = 45s
UD_SosMdTimePre = 30s
UD_SosMdTimeRep = 60s
UD_SosMdTone = true
UD_SosMdVibra = false

### function/feature access
UD_FunctionMenuHide=active_features true
UD_FunctionMenuHide=prog_x TRUE
UD_FunctionLocked=time_x true
UD_FunctionUserProtected=system_x true
UD_FunctionUserProtected=dir_x true
UD_FunctionAdminProtected=system_x true
UD_FunctionGrayed=system_x true
```



```

### assignment of keys
UD_KeyAssignmentIdle=side1 caller
UD_KeyAssignmentIdle=ok MenuInfNew
UD_KeyAssignmentIdle=long.ok inf
UD_KeyAssignmentIdle=esc gappp_directory
UD_KeyAssignmentIdle=long.esc directories

UD_KeyAssignmentActive=esc nop

UD_KeyAssignmentIdle=side1 sos_loc
UD_KeyAssignmentIdle=side2 shock
UD_KeyAssignmentIdle=side3 sensor_menu

```

## 10.4.2 SUPPORTED COA PARAMETERS

The following keys and values are supported in the CoA configuration files.

```

UD_ConfigurationName=      // <string>

// message melody options
UD_MessageMelodyNormal=    // VAL_MELODY_xxx
UD_MessageMelodyUrgent=    // VAL_MELODY_xxx
UD_MessageMelodyAlarm=     // VAL_MELODY_xxx

// message volume options
UD_MessageVolumeNormal=    // VAL_VOLUME_xxx
UD_MessageVolumeUrgent=    // VAL_VOLUME_xxx
UD_MessageVolumeAlarm=     // VAL_VOLUME_xxx

// message overwrite
UD_MessageOverwrite=       // true/false

// ringer melody options
UD_RingerMelodyIntern=     // VAL_MELODY_xxx
UD_RingerMelodyExtern=     // VAL_MELODY_xxx
UD_RingerMelodyUnknown=    // VAL_MELODY_xxx
UD_RingerMelodyCallback=   // VAL_MELODY_xxx
UD_RingerMelodyRecall=     // VAL_MELODY_xxx
UD_RingerMelodyVip=        // VAL_MELODY_xxx
UD_RingerMelodySpecial=    // VAL_MELODY_xxx
UD_RingerMelodyAlarm=      // VAL_MELODY_xxx
UD_RingerMelodyAppointment= // VAL_MELODY_xxx

// melodies
"weekend"                  // Weekend
"butterfly"                // Butterfly
"barock"                   // Barock
"ballade"                  // Ballade
"fancy"                    // Fancy
"comelody"                 // Comelody
"easy_groove"              // Easy groove
"happy_fair"               // Happy fair
"kitafun"                  // Kitafun

```

```
"latin_dance"           // Latin dance
"little_asia"          // Little asia
"mango_selassi"       // Mango selassi
"parka"               // Parka
"remember"            // Remember
"rocky_lane"          // Rocky lane
"ringing_1"           // Ringing 1
"ringing_2"           // Ringing 2
"ringing_3"           // Ringing 3
"ringing_4"           // Ringing 4
"ringing_5"           // Ringing 5
"ringing_6"           // Ringing 6
"ringing_7"           // Ringing 7
"ring_vintage"        // Ring vintage
"vibes"               // Vibes
"attack"              // Attack
"doorbell"            // Doorbell
"boogie"              // Boogie
"polka"               // Polka
"classical_1"         // Classical 1
"classical_2"         // Classical 2
"classical_3"         // Classical 3
"classical_4"         // Classical 4
"alla_turca"         // Alla turca
"entertainer"        // Entertainer
"jollygood"          // Jollygood
"in_the_saints"       // In the saints
"drunken_sailor"     // Drunken sailor
"mary_had"            // Mary had
"shell_be_walking"    // Shell be walking
"pippi_longstocking" // Pippi longstocking
"policehorn"         // Policehorn
"synthesizer"        // Synthesizer
"after_work"         // After work
"beep"               // Beep
"basic_1"            // Basic 1
"basic_2"            // Basic 2
"basic_3"            // Basic 3
"basic_4"            // Basic 4
"basic_5"            // Basic 5
"basic_6"            // Basic 6
"basic_7"            // Basic 7
"basic_8"            // Basic 8
"alarm_1"            // Alarm 1
"alarm_2"            // Alarm 2
"alarm_3"            // Alarm 3
"alarm_4"            // Alarm 4
"alarm_5"            // Alarm 5
"alarm_6"            // Alarm 6
"alarm_7"            // Alarm 7
"6700_one"           // 6700 One
"6700_two"           // 6700 Two
"6700_three"         // 6700 Three
"6700_four"          // 6700 Four
"6700_five"          // 6700 Five
"1_attention_tone"   // 1 Attention tone
"2_attention_tones" // 2 Attention tones
"3_attention_tones" // 3 Attention tones
"4_attention_tones" // 4 Attention tones
"5_attention_tones" // 5 Attention tones
"6_attention_tones" // 6 Attention tones
```

```

"7_attention_tones" // 7 Attention tones
"8_attention_tones" // 8 Attention tones
"9_attention_tones" // 9 Attention tones
"10_attention_tones" // 10 Attention tones

// ringer volume options
UD_RingerVolumeIntern= // VAL_VOLUME_xxx
UD_RingerVolumeExtern= // VAL_VOLUME_xxx
UD_RingerVolumeUnknown= // VAL_VOLUME_xxx
UD_RingerVolumeCallback= // VAL_VOLUME_xxx
UD_RingerVolumeRecall= // VAL_VOLUME_xxx
UD_RingerVolumeVip= // VAL_VOLUME_xxx
UD_RingerVolumeSpecial= // VAL_VOLUME_xxx
UD_RingerVolumeAlarm= // VAL_VOLUME_xxx
UD_RingerVolumeAppointment= // VAL_VOLUME_xxx

// volumes
"off" // off
"increasing" // increasing
"level_1" // Level-1
"level_2" // Level-2
"level_3" // Level-3
"level_4" // Level-4
"level_5" // Level-5
"level_6" // Level-6
"level_7" // Level-7

// ringer settings
UD_RingMode= // VAL_RING_MODE_xxx
UD_RingBuzz= // true/false
UD_RingVibra= // true/false
UD_RingHeadset= // true/false

"repeat" // repeat
"once" // once

// attention tones
UD_ToneKey= // VAL_TONE_xxx (up to 3 values)
UD_ToneCnf= // VAL_TONE_xxx (up to 3 values)
UD_ToneMnend= // VAL_TONE_xxx (up to 3 values)
UD_ToneAccu= // VAL_TONE_xxx (up to 3 values)
UD_ToneRange= // VAL_TONE_xxx (up to 3 values)
UD_ToneOutrange= // VAL_TONE_xxx (up to 3 values)

"inactive" // inactive
"active" // active
"no_speaker" // without Loudspeaker
"vibra" // Vibration

// audio
UD_AudioNoisedetect= // true/false
UD_AudioLoudenv= // true/false
UD_AudioSpkCharger= // VAL_AUDIO_SPK_CHARGER_xxx

"release" // Release
"handsfree" // Handsfree

// Systems/Subscription/<System X>
UD_DialCharset= // VAL_DIAL_ABC_xxx
UD_DialCodeImax= // VAL_DIAL_CODE_IMAX_xxx
UD_DialCodeSys= // <digit-string>

```

```
"123_" // 123...
"ABC_123" // ABC...123
"123_ABC_äöü" // 123...ABC...äöü
"ABC_äöü_123" // ABC...äöü...123
"123_ABC" // 123...ABC

"automatic" // automatic
"1" // 1
"2" // 2
"3" // 3
"4" // 4
"5" // 5
"6" // 6
"7" // 7
"8" // 8

// display
UD_DisplLang= // VAL_DISP_LANG_xxx
UD_DisplFont= // VAL_DISP_FONT_xxx
UD_DisplColor= // VAL_DISP_COLOR_xxx

"default" // default
"de" // D - Deutsch
"en" // GB - English
"fr" // FR - Français
"es" // ES - Español
"it" // I - Italiano
"nl" // NL - Nederlands
"sv" // S - Svenska
"da" // DK - Dansk
"pt" // P - Português
"no" // N - Norsk
"cs" // Cz - Cesky
"sk" // SK - Sloven?ina - Slovensky
"fi" // Su - Suomi
"hu" // H - Magyar - Hungarian
"ru" // RU - ??????? - Russian
"tr" // TURK - Türkçe
"pl" // PL - Polski
"et" // EST - Esti

"small" // Small
"normal" // Normal
"large" // Large

"gray" // Gray
"black" // Black
"business" // Business
"future" // Future
"plain" // Plain
"sweet" // Sweet

// illumination
UD_LightDim= // VAL_LIGHT_DIM_xxx
UD_LightDisp= // VAL_LIGHT_DISP_xxx
UD_LightKey= // VAL_LIGHT_KEY_xxx
UD_LightKeyoptIncom= // true/false
UD_LightKeyoptAlarm= // true/false
UD_LightKeyoptCharge= // true/false
UD_LightCharge= // VAL_LIGHT_CHARGE_xxx
```

---

```
UD_LightCall=           // VAL_LIGHT_CALL_xxx
UD_LightMsgMsg=        // VAL_LIGHT_MSG_MSG_xxx
UD_LightMsgInf=        // VAL_LIGHT_MSG_INF_xxx
UD_LightMsgJob=        // VAL_LIGHT_MSG_JOB_xxx
UD_LightMsgSos=        // VAL_LIGHT_MSG_SOS_xxx

"off"                   // off
"1m"                    // 1 min
"10m"                   // 10 min
"1h"                    // 60 min
"2h"                    // 120 min
"4h"                    // 240 min
"10h"                   // 600 min
"on"                    // on

"10s"                   // 10 sec
"20s"                   // 20 sec
"30s"                   // 30 sec
"45s"                   // 45 sec
"60s"                   // 60 sec
"2m"                    // 120 sec
"4m"                    // 240 sec

"off"                   // off
"1s"                    // 1 sec
"3s"                    // 3 sec
"5s"                    // 5 sec
"10s"                   // 10 sec
"20s"                   // 20 sec
"30s"                   // 30 sec
"45s"                   // 45 sec
"60s"                   // 60 sec
"2m"                    // 120 sec
"4m"                    // 240 sec

"off"                   // off
"1s"                    // 1 sec
"3s"                    // 3 sec
"5s"                    // 5 sec
"10s"                   // 10 sec
"20s"                   // 20 sec
"30s"                   // 30 sec
"45s"                   // 45 sec
"60s"                   // 60 sec
"2m"                    // 120 sec
"4m"                    // 240 sec

"off"                   // off
"1s"                    // 1 sec
"3s"                    // 3 sec
"5s"                    // 5 sec
"10s"                   // 10 sec
"20s"                   // 20 sec
"30s"                   // 30 sec
"45s"                   // 45 sec
"60s"                   // 60 sec
"2m"                    // 120 sec
"3m"                    // 180 sec
"4m"                    // 240 sec
"on"                    // on
```

```

"nochange"           // No change
"dimmed"             // Light dimmed
"5s"                 // 5 sec
"10s"                // 10 sec
"20s"                // 20 sec
"30s"                // 30 sec
"45s"                // 45 sec
"60s"                // 60 sec
"2m"                 // 120 sec
"4m"                 // 240 sec

"nochange"           // No change
"dimmed"             // Light dimmed
"5s"                 // 5 sec
"10s"                // 10 sec
"20s"                // 20 sec
"30s"                // 30 sec
"45s"                // 45 sec
"60s"                // 60 sec
"2m"                 // 120 sec
"4m"                 // 240 sec

"nochange"           // No change
"dimmed"             // Light dimmed
"5s"                 // 5 sec
"10s"                // 10 sec
"20s"                // 20 sec
"30s"                // 30 sec
"45s"                // 45 sec
"60s"                // 60 sec
"2m"                 // 120 sec
"4m"                 // 240 sec

"dimmed"             // Light dimmed
"30s"                // 30 sec
"60s"                // 60 sec
"2m"                 // 120 sec
"3m"                 // 180 sec
"4m"                 // 240 sec
"5m"                 // 300 sec

// led indications
UD_LedAlive=         // true/false
UD_LedIncom=         // true/false
UD_LedRange=         // true/false
UD_LedCharge=        // true/false
UD_LedInfo=          // true/false
UD_LedSpk=           // true/false
UD_LedAppoint=       // true/false
UD_LedAlarm=         // true/false

// list access
UD_ListmodeRedial=   // VAL_LISTMODE_REDIAL_xxx
UD_ListmodeCaller=   // VAL_LISTMODE_CALLER_xxx
UD_ListmodeFilter=   // VAL_LISTMODE_FILTER_xxx

"local"              // local
"automatic"          // automatic
"pbx"                // PBX

"local"              // local

```

```

"automatic"          // automatic
"pbx"                // PBX

"accept_list"       // Accept list
"block_list"        // Block list
"filter_off"        // Filter off

// device options
UD_ModeSilentcharge= // true/false
UD_ModeChargeranswr= // true/false
UD_ModeAutoanswr=    // true/false
UD_ModeAutoquickhook= // true/false
UD_ModeKey=          // VAL_MODE_KEY_xxx

"emo"                // Esc >>> Ok
"oem"                // Ok Esc >>>
"eom"                // Esc Ok >>>
"meo"                // >>> Esc Ok
"EMO"                // Esc Menu Ok
"OEM"                // Ok Esc Menu
"EOM"                // Esc Ok Menu
"MEO"                // Menu Esc Ok

// phone lock
UD_LockKeyAuto=      // true/false
UD_LockKeyTime=      // VAL_LOCK_KEY_T_xxx
UD_LockKeyPin=       // true/false
UD_LockPin=          // <digit-string>
UD_LockAdmin=        // <digit-string>

"5s"                 // 5 sec
"10s"                // 10 sec
"20s"                // 20 sec
"30s"                // 30 sec
"40s"                // 40 sec
"50s"                // 50 sec
"60s"                // 60 sec
"90s"                // 90 sec
"120s"               // 120 sec

// SOS call
UD_SosNumber=        // <digit-string>
UD_SosMelody=        // VAL_MELODY_xxx
UD_SosVolume=        // VAL_VOLUME_xxx
UD_SosHandsfree=     // true/false

// alarm sensor
UD_SosMdNumber=      // <digit-string>
UD_SosMdAutoanswr=   // true/false
UD_SosMdModePre=     // true/false
UD_SosMdModeDown=    // true/false
UD_SosMdModeNomove=  // true/false
UD_SosMdModeEsc=     // true/false
UD_SosMdModeRep=     // true/false
UD_SosMdSenseAngle=  // VAL_SOSMD_SENSE_ANGLE_xxx
UD_SosMdSenseMove=   // VAL_SOSMD_SENSE_MOVE_xxx
UD_SosMdSenseEsc=    // VAL_SOSMD_SENSE_ESC_xxx
UD_SosMdNomoDown=    // VAL_SOSMD_NOMO_xxx (up to 4 values)
UD_SosMdNomoNomove=  // VAL_SOSMD_NOMO_xxx (up to 4 values)
UD_SosMdNomoEsc=     // VAL_SOSMD_NOMO_xxx (up to 4 values)
UD_SosMdDelayDown=   // VAL_SOSMD_DELAY_DOWN_xxx

```

```
UD_SosMdDelayNomove= // VAL_SOSMD_DELAY_NOMOVE_xxx
UD_SosMdDelayEsc= // VAL_SOSMD_DELAY_ESC_xxx
UD_SosMdTimePre= // VAL_SOSMD_T_PRE_xxx
UD_SosMdTimeRep= // VAL_SOSMD_T_REP_xxx
UD_SosMdTone= // true/false
UD_SosMdVibra= // true/false

"steep" // Steep
"medium" // Medium
"flat" // Flat

"low" // Low
"medium" // Medium
"high" // High

"low" // Low
"medium" // Medium
"high" // High

"idle" // in idle
"conversation" // during conversation
"local_menu" // in local menu
"system_menu" // in system menu

"1s" // 1 sec
"2s" // 2 sec
"5s" // 5 sec
"10s" // 10 sec
"20s" // 20 sec
"30s" // 30 sec
"45s" // 45 sec
"60s" // 60 sec
"75s" // 75 sec

"10s" // 10 sec
"20s" // 20 sec
"30s" // 30 sec
"45s" // 45 sec
"60s" // 60 sec
"75s" // 75 sec

"1s" // 1 sec
"2s" // 2 sec
"5s" // 5 sec
"10s" // 10 sec
"20s" // 20 sec
"30s" // 30 sec
"45s" // 45 sec
"60s" // 60 sec
"75s" // 75 sec

"10s" // 10 sec
"20s" // 20 sec
"30s" // 30 sec
"45s" // 45 sec
"60s" // 60 sec
"75s" // 75 sec

"5s" // 5 sec
"10s" // 10 sec
"20s" // 20 sec
```



```

"30s"           // 30 sec
"45s"           // 45 sec
"60s"           // 60 sec
"75s"           // 75 sec
"120s"          // 120 sec
"240s"          // 240 sec

// function/feature access
UD_FunctionMenuHide=      // VAL_FUNCTION_xxx and true/false
UD_FunctionLocked=        // VAL_FUNCTION_xxx and true/false
UD_FunctionGrayed=        // VAL_FUNCTION_xxx and true/false
UD_FunctionUserProtected= // VAL_FUNCTION_xxx and true/false
UD_FunctionAdminProtected= // VAL_FUNCTION_xxx and true/false

// functions/features available on device
"pbx_unpark"           // <<< Unpark call(*)
"pbx_park"             // <<< Pickup/Park(*)
"gappp_pickup"         // <<< Pickup call(*)
"pbx_take"             // <<< Take call(*)
"gappp_call_forward"   // <<< Call diversion(*)
"pbx_call_routing"     // <<< Call routing(*)
"gappp_pickup_select" // Pickup select
"gappp_announcement"   // Announcement
"gappp_intercom"        // Intercom
"gappp_vip_call"        // VIP call
"inf"                  // >>> Info (menu item only)
"caller"               // Caller list
"redial"               // Redial list
"box_x"                // >>> Voice box
"box_set_x"            // Voice box settings
"voice_box_menu"       // Settings/Voice mail(*)
"active_features"      // >>> Active features
"msg_x"                // >>> Text message / Jobs / Mails(*)
"omm_def_msg"          // Pre-defined messages
"msg_opt_x"            // Message options
"mel_msg_x"            // Melodies
"mel_msg"              // Normal message
"mel_msgurg"           // Urgent message
"mel_msgsos"           // Alarm message
"vol_msg_x"            // Volume
"vol_msg"              // Normal message
"vol_msgurg"           // Urgent message
"vol_msgsos"           // Alarm message
"msg_pop"              // Popup
"msg_ovwr"             // Overwrite
"msg_del"              // Delete/Delete all
"directory_x"          // >>> Directories
"vip"                  // VIP list
"vip_x"                // Edit/Add VIP list entry
"dir_x"                // Personal directory
"book_x"               // Edit/Add personal directory entry
"quick_x"              // Quick call
"add_to"               // Add to...(VIP/Filter/Personal/Central directory)
"pbx_directory"        // Central directory(*)
"time_x"               // >>> Time functions
"alarm_x"              // Alarm clock 1...3
"appointment_x"        // Appointment 1...3
"tea_timer"            // Timer
"audio_x"              // >>> Audio
"volume_menu"          // Volume settings
"tone_menu"            // Attention tones

```

```
"tone_key"           // Key click
"tone_cnf"           // Confirm tones
"tone_end"           // End of menu
"tone_bat"           // Battery warning
"tone_charger"       // Charger beep
"tone_cov"           // Coverage warning
"tone_range"         // Out of range
"tone_wait"          // Call waiting
"tone_sensor"        // Pre alarm (63x only)
"load_environment"   // Loud environment
"audio_hd"           // Audio quality (only 650)
"ring_x"             // >>> Ringing
"ring_mel_x"         // Ringer melodies
"mel_int"            // Internal call
"mel_ext"            // External call
"mel_unk"            // Unknown number
"mel_nym"            // Anonymous
"mel_ccbs"           // Callback
"mel_recall"         // Recall
"mel_vip"            // VIP call
"mel_special"        // Special call
"mel_sos"            // Emergency call
"mel_alarm"          // Alarm
"mel_app"            // Appointment
"ring_volume"        // Ringer volume
"vol_int"            // Internal call
"vol_ext"            // External call
"vol_unk"            // Unknown number
"vol_nym"            // Anonymous
"vol_ccbs"           // Callback
"vol_recall"         // Recall
"vol_vip"            // VIP call
"vol_special"        // Special call
"vol_sos"            // Emergency call
"vol_alarm"          // Alarm
"vol_app"            // Appointment
"ring_type_x"        // Ringer type
"play_once"          // Play melody once on/off
"silent_charging"    // Silent charging
"noise_detection"    // Noise detection on/off
"ring_device_x"      // Ringer device
"ring_off"           // Ringer/Buzzer on/off
"ring_hs"            // Corded headset-ring on/off
"ring_vibra"         // Vibrator-ring on/off
"datamanagment"     // >>> Data management / SD Card
"filter_xx"          // >>> Call filter
"filter_x"           // Edit call filter
"system_x"           // >>> System/Subscription
"start_enrol"        // <New system>
"subs_auto"          // Auto search
"subs_sel"           // Select subscription
"subs_stop"          // Stop searching
"subs_opt"           // >Edit subscription
"no_plan"            // Number plan
"ehs_x"              // >>> Enhanced security
"bt_x"               // >>> Bluetooth (only 62x/63x/65x)
"bt_edit_x"          // >Edit Bluetooth
"set_xx"             // >>> User settings
"prog_x"             // Key programming
"disp_x"             // Display settings
"language"           // Language
```

```
"font" // Font settings
"color" // Color schemes
"scheme" // Menu structure
"pic_x" // Idle picture
"illu_x" // Illumination/Light
"disp_dim" // Display dimming
"disp_light" // Display
"disp_key" // Keyboard
"disp_charger" // Charger
"disp_call" // Conversation
"disp_inf" // Info message
"disp_msg" // Text message
"disp_job1" // Job
"disp_sos" // SOS alarm
"disp_led" // LED indications
"led_alife" // Life indication
"led_incom" // Incoming call
"led_range" // Out of range
"led_charge" // Charge indication
"led_inf" // Infos
"led_spk" // Handsfree
"led_app" // Appointment
"led_alarm" // Alarm
"list_settings" // List access
"device_opt" // Device options
"security_x" // >>> Security
"lock_x" // >>> Lock
"keylock" // Key lock
"pinlock" // Phone lock
"change_pin" // Change PIN
"sos_x" // >>> SOS call
"tms_x" // >>> Alarm sensor (63x only)
"set_pre_alarm" // Pre alarm
"set_mandown" // Mandown
"set_no_move" // No movement alarm
"set_shock" // Shock alarm
"set_rep_alarm" // Repeate alarm
"tms_opt_x" // >Sensor options
"rst_x" // >>> Reset to default
"off_menu" // >>> Off menu
"off" // Power off
"menu" // Menu
"ring_toggle" // Ringer/Buzzer on/off
"profile_x" // >>> Profiles
"prof_no" // <No profile>
"prof_norm" // Normal
"prof_hs" // Headset
"prof_meet" // Meeting
"prof_loud" // Loud
"prof_my" // <Profile 05>
"prof_ed_x" // Edit profiles
"prof_ed_norm" // Edit Normal
"prof_ed_hs" // Edit Headset
"prof_ed_meet" // Edit Meeting
"prof_ed_loud" // Edit Loud
"usb_mode" // USB mode
"doa_master" // DOA master
"f_x" // <<< XML Applications / Functions 01..10(*)
"pbx_fkeys" // <<< List of applications / functions(*)
"f_1" // App/F01(*)
"f_2" // App/F02(*)
```

```
"f_3"           // App/F03 (*)
"f_4"           // App/F04 (*)
"f_5"           // App/F05 (*)
"f_6"           // App/F06 (*)
"f_7"           // App/F07 (*)
"f_8"           // App/F08 (*)
"f_9"           // App/F09 (*)
"f_10"          // App/F10 (*)
"vlstx"         // Variable lists
"vlst1"         // Variable list 1
"vlst1_1"       // List 1 item 1
"vlst1_2"       // List 1 item 2
"vlst1_3"       // List 1 item 3
"vlst1_4"       // List 1 item 4
"vlst1_5"       // List 1 item 5
"vlst1_6"       // List 1 item 6
"vlst1_7"       // List 1 item 7
"vlst1_8"       // List 1 item 8
"vlst1_9"       // List 1 item 9
"vlst1_10"      // List 1 item 10
"vlst2"         // Variable list 2
"vlst2_1"       // List 2 item 1
"vlst2_2"       // List 2 item 2
"vlst2_3"       // List 2 item 3
"vlst2_4"       // List 2 item 4
"vlst2_5"       // List 2 item 5
"vlst2_6"       // List 2 item 6
"vlst2_7"       // List 2 item 7
"vlst2_8"       // List 2 item 8
"vlst2_9"       // List 2 item 9
"vlst2_10"      // List 2 item 10
"menu_x"        // All menus
"opt"           // All dial/call options

// assignment of keys
UD_KeyAssignmentIdle= // VAL_KEY_xxx and VAL_FKT_IDLE_xxx
UD_KeyAssignmentDial= // VAL_KEY_xxx and VAL_FKT_DIAL_xxx
UD_KeyAssignmentAlert= // VAL_KEY_xxx and VAL_FKT_ALERT_xxx
UD_KeyAssignmentActive= // VAL_KEY_xxx and VAL_FKT_ACTIVE_xxx

UD_KeyAssignmentIdleMaster= // VAL_KEY_xxx and VAL_FKT_IDLE_xxx
UD_KeyAssignmentDialMaster= // VAL_KEY_xxx and VAL_FKT_DIAL_xxx
UD_KeyAssignmentAlertMaster= // VAL_KEY_xxx and VAL_FKT_ALERT_xxx
UD_KeyAssignmentActiveMaster= // VAL_KEY_xxx and VAL_FKT_ACTIVE_xxx

// keys available on device
"sos"           // SOS-key (sos)
"side1"         // Side key up (side1)
"side2"         // Side key middle (side2)
"side3"         // Side key down (side3)
"vip"           // Hotkey (vip)
"ok"            // Softkey left (ok)
"esc"           // Softkey middle (esc)
"opt"           // Softkey right (opt)
"left"          // Navi. left (left)
"right"         // Navi. right (right)
"up"            // Navi. up (up)
"down"          // Navi. down (down)
"green"         // Hook off (green)
"red"           // Hook on (red)
"long.sos"      // SOS-key long (long.sos)
```

```

"long.side1" // Side key up long (long.side1)
"long.side2" // Side key middle long (long.side2)
"long.side3" // Side key down long (long.side3)
"long.vip" // Hotkey long (long.vip)
"long.ok" // Softkey left long (long.ok)
"long.esc" // Softkey middle long (long.esc)
"long.opt" // Softkey right long (long.opt)
"long.left" // Navi. left long (long.left)
"long.right" // Navi. right long (long.right)
"long.green" // Hook off long (long.green)
"long.red" // Hook on long (long.red)
"long.d0" // Key 0 long (long.d0)
"long.d1" // Key 1 long (long.d1)
"long.d2" // Key 2 long (long.d2)
"long.d3" // Key 3 long (long.d3)
"long.d4" // Key 4 long (long.d4)
"long.d5" // Key 5 long (long.d5)
"long.d6" // Key 6 long (long.d6)
"long.d7" // Key 7 long (long.d7)
"long.d8" // Key 8 long (long.d8)
"long.d9" // Key 9 long (long.d9)
"long.star" // Star key long (long.star)
"long.hash" // Hash key long (long.hash)
"d0" // Key 0 (d0)
"d1" // Key 1 (d1)
"d2" // Key 2 (d2)
"d3" // Key 3 (d3)
"d4" // Key 4 (d4)
"d5" // Key 5 (d5)
"d6" // Key 6 (d6)
"d7" // Key 7 (d7)
"d8" // Key 8 (d8)
"d9" // Key 9 (d9)
"star" // Star key (star)
"hash" // Hash key (hash)
"del" // C-key (del)
"spk" // Handsfree (spk)
"long.del" // C-key long (long.del)
"long.spk" // Handsfree long (long.spk)

// functions available in IDLE state
"nop" // <no function>
"prog" // <key programming>
"menu" // >>>Menu
"dyn_pbx_option" // >>>System options / main menu
"pbx_server_menu" // >>>Server menu
"alarm_time" // Time/Alarms
"alarm" // Alarm clock
"appointment" // Appointment
"tea_timer" // Timer
"directories" // Directories (Personal/Central/VIP-list)
"get_name" // Get name from personal directory
"book" // Personal directory
"gappp_directory" // Central directory (obsolete)
"pbx_directory" // Central directory(*)
"vip" // VIP list
"quick0" // Quick call list
"sos_menu" // SOS call: with confirmation
"sos" // SOS call
"sos_loc" // Localisation alarm
"shock" // Shock detection

```

```
"alarm_call"           // Alarm call
"sensor_menu"         // Alarm sensor
"navi"                // Navigation key
"inf"                 // (i) Info menu
"MenuInfNew"          // (i) New infos
"voice_box"           // Voice box
"caller"              // Caller list
"redial"              // Redial list
"omm_jobs"            // Job list
"BestMsg"             // Text messages
"omm_inbox"           // Inbox/Text messages
"omm_outbox"          // Outbox/Text messages
"omm_def_msg"         // Pre-defined messages
"txt_send"            // Send new text message
"active_features"     // Active Handset features
"feature_access_code" // Feature access codes(*)
"pbx_unpark"          // Unpark call(*)
"gappp_pickup"        // Pickup call(*)
"pbx_take"            // Take call(*)
"locating_editor"     // Locating(*)
"pbx_presence"        // Presence(*)
"pbx_dnd"              // Call protection(*)
"gappp_call_forward" // Call diversion(*)
"pbx_call_routing"    // Call routing(*)
"profile"              // Profile
"datamanagment"       // Data managment
"keylock"              // Key lock
"pinlock"              // Pin/Phone lock
"light_toggle"        // Light on/off
"bt"                  // Bluetooth settings
"bt_state"             // BT status (on/off)
"ring_off"            // Ringer on/off
"vol_ok"               // Volume settings
"audio_hd"             // HiQ audio on/off
"off"                  // Power off
"predial"             // Please dial editor
"version"              // Version info
"filter_menu"          // Call filter
"filter_state"         // Call filter state
"pbx_fkeys"           // XML Applications
"f_1"                  // App 1
"f_2"                  // App 2
"f_3"                  // App 3
"f_4"                  // App 4
"f_5"                  // App 5
"f_6"                  // App 6
"f_7"                  // App 7
"f_8"                  // App 8
"f_9"                  // App 9
"f_10"                 // App 10
"vlstx"                // Variable lists
"vlst1"                // Variable list 1
"vlst1_1"              // List 1 item 1
"vlst1_2"              // List 1 item 2
"vlst1_3"              // List 1 item 3
"vlst1_4"              // List 1 item 4
"vlst1_5"              // List 1 item 5
"vlst1_6"              // List 1 item 6
"vlst1_7"              // List 1 item 7
"vlst1_8"              // List 1 item 8
"vlst1_9"              // List 1 item 9
```

```
"vlst1_10" // List 1 item 10
"vlst2" // Variable list 2
"vlst2_1" // List 2 item 1
"vlst2_2" // List 2 item 2
"vlst2_3" // List 2 item 3
"vlst2_4" // List 2 item 4
"vlst2_5" // List 2 item 5
"vlst2_6" // List 2 item 6
"vlst2_7" // List 2 item 7
"vlst2_8" // List 2 item 8
"vlst2_9" // List 2 item 9
"vlst2_10" // List 2 item 10

// functions available in DIAL state
"nop" // <no function>
"sk_dyn1" // <dynamic soft-key>
"caller" // Caller list
"redial" // Redial list
"get_name" // Get name from personal directory
"book_req" // Personal directory
"gappp_directory" // Central directory (obsolete)
"pbx_directory" // Central directory(*)
"vip" // VIP list
"add_to" // Add to... (VIP-, Filter-list, Personal directory)
"gappp_pickup_select" // Pickup select
"gappp_vip_call" // VIP call
"gappp_announcement" // Announcement
"gappp_intercom" // Intercom
"vlstx" // Variable lists
"vlst1" // Variable list 1
"vlst1_1" // List 1 item 1
"vlst1_2" // List 1 item 2
"vlst1_3" // List 1 item 3
"vlst1_4" // List 1 item 4
"vlst1_5" // List 1 item 5
"vlst1_6" // List 1 item 6
"vlst1_7" // List 1 item 7
"vlst1_8" // List 1 item 8
"vlst1_9" // List 1 item 9
"vlst1_10" // List 1 item 10
"vlst2" // Variable list 2
"vlst2_1" // List 2 item 1
"vlst2_2" // List 2 item 2
"vlst2_3" // List 2 item 3
"vlst2_4" // List 2 item 4
"vlst2_5" // List 2 item 5
"vlst2_6" // List 2 item 6
"vlst2_7" // List 2 item 7
"vlst2_8" // List 2 item 8
"vlst2_9" // List 2 item 9
"vlst2_10" // List 2 item 10

// functions available in ALERTING state
"nop" // <no function>
"na" // <not available>
"sk_dyn1" // <dynamic soft-key>
"opt" // >>>Call options
"acc" // Accept call / Hook off
"rej" // Reject call / Hook on
"ring_off" // Ringing off
"add_to" // Add to... (VIP-, Filter-list, Personal directory)
```

```
"opt_ccbs"           // Callback CCBS
"opt_ccnr"          // Callback CCNR
"opt_mcid"          // Intercept MCID
"opt_pickup"        // Pickup call
"opt_pickup_select" // Pickup select
"opt_park"          // Park call/Unpark call
"opt_take"          // Take call
"vlstx"            // Variable lists
"vlst1"            // Variable list 1
"vlst1_1"          // List 1 item 1
"vlst1_2"          // List 1 item 2
"vlst1_3"          // List 1 item 3
"vlst1_4"          // List 1 item 4
"vlst1_5"          // List 1 item 5
"vlst1_6"          // List 1 item 6
"vlst1_7"          // List 1 item 7
"vlst1_8"          // List 1 item 8
"vlst1_9"          // List 1 item 9
"vlst1_10"         // List 1 item 10
"vlst2"            // Variable list 2
"vlst2_1"          // List 2 item 1
"vlst2_2"          // List 2 item 2
"vlst2_3"          // List 2 item 3
"vlst2_4"          // List 2 item 4
"vlst2_5"          // List 2 item 5
"vlst2_6"          // List 2 item 6
"vlst2_7"          // List 2 item 7
"vlst2_8"          // List 2 item 8
"vlst2_9"          // List 2 item 9
"vlst2_10"         // List 2 item 10

// functions available in ACTIVE state
"nop"               // <no function>
"sk_dyn1"           // <dynamic soft-key>
"opt"               // >>>Call options
"pbx_server_menu"   // >>>Server menu(*)
"feature_access_code" // >>>Feature access codes(*)
"dial_r"            // (R) Register recall
"opt_ect"           // Transfer call
"opt_brokering"     // Brokering
"opt_hold"          // Hold call
"opt_3pty"          // Conference start/stopp
"opt_park"          // Park call/Unpark call
"rel"               // Release call / Hook on
"add_to"            // Add to... (VIP-, Filter-list, Personal directory)
"book"              // Personal directory
"gappp_directory"   // Central directory (obsolete)
"pbx_directory"     // Central directory(*)
"vip"               // VIP list
"quick0"            // Quick call list
"filter"            // Call filter list
"caller"            // Caller list
"redial"            // Redial list
"txt_send"          // Send new text message
"vol_ok"            // Volume settings
"vol_up"            // Volume +
"vol_down"          // Volume -
"mute"              // Microphone on/off
"audio_hd"          // HiQ audio on/off
"bt_toggle"         // Transfer BT <-> Handset
"opt_mcid"          // Intercept MCID
```



```

"opt_pickup"           // Pickup
"opt_pickup_select"   // Pickup select
"opt_take"            // Take call
"vlstx"               // Variable lists
"vlst1"               // Variable list 1
"vlst1_1"             // List 1 item 1
"vlst1_2"             // List 1 item 2
"vlst1_3"             // List 1 item 3
"vlst1_4"             // List 1 item 4
"vlst1_5"             // List 1 item 5
"vlst1_6"             // List 1 item 6
"vlst1_7"             // List 1 item 7
"vlst1_8"             // List 1 item 8
"vlst1_9"             // List 1 item 9
"vlst1_10"            // List 1 item 10
"vlst2"               // Variable list 2
"vlst2_1"             // List 2 item 1
"vlst2_2"             // List 2 item 2
"vlst2_3"             // List 2 item 3
"vlst2_4"             // List 2 item 4
"vlst2_5"             // List 2 item 5
"vlst2_6"             // List 2 item 6
"vlst2_7"             // List 2 item 7
"vlst2_8"             // List 2 item 8
"vlst2_9"             // List 2 item 9
"vlst2_10"            // List 2 item 10

UD_VListName=         // <list-index 1..2> <utf8-string>
UD_VListShortName=    // <list-index 1..2> <utf8-string>
UD_VListSubItems=     // <list-index 1..2> <boolean>

// list-index      item-index      number-to-dial  longname      function-id
shortname/icon     handsfree      visible(idle,dial,alert,active)
// 1..2           1..10
VAL_FKT_VLIST_xxx      true/false/1/0
  UD_VListEntry=       // <string>      <string>      <utf8-string>  <utf8-string>
<string>             <utf8-string>  <boolean>     <4-digit-string-of(0,1)>

// functions available in VLIST
"x"                  // Dummy-Function_ID
"vlst1"              // Variable list 1
"vlst2"              // Variable list 2
"menu"               // Menu
"active_features"    // Active Handset features
"alarm"              // Alarm clock
"appointment"        // Appointment
"tea_timer"          // Timer
"show_time_date"     // Date/Time
"bt"                 // Bluetooth settings
"bt_state"           // BT status (on/off)
"datamanagment"     // Data managment
"keylock"            // Key lock
"pinlock"            // Pin/Phone lock
"profile"            // Profile
"predial"            // Please dial editor
"off"                // Power off
"off_menu"           // Off menu
"ring_off"           // Ringer on/off
"audio_hd"           // HiQ audio on/off
"vol_ok"             // Volume settings
"light_toggle"       // Light on/off

```

```
"version"           // Version info
"navi"             // Navigation key
"inf"             // (i) Info menu
"MenuInfNew"      // (i) New infos
"voice_box"       // Voice box
"caller"         // Caller list
"redial"         // Redial list
"pbx_email"      // Email list
"pbx_fax"        // Fax list
"omm_jobs"       // Job list
"BestMsg"        // Text messages
"omm_inbox"      // Inbox/Text messages
"omm_outbox"     // Outbox/Text messages
"omm_def_msg"    // Pre-defined messages
"txt_send"       // Send new text message
"gappp_cost"     // Cost infos
"pbx_feature"    // Active PBX features
"filter_menu"    // Call filter
"filter_state"   // Call filter state
"filter_list"    // Call filter list
"directories"     // Directories (Personal/Central/VIP-list)
"get_name"       // Get name from personal directory
"book"           // Personal directory
"gappp_intern"   // Internal directory
"pbx_directory"  // Central directory
"vip"            // VIP list
"feature_access_code" // Feature access codes
"pbx_reception"  // Hotel reception
"quick0"         // Quick call list
"sos_menu"       // SOS call: with confirmation
"sos"           // SOS call
"sos_loc"        // Localisation alarm
"shock"          // Shock detection
"alarm_call"     // Alarm call
"sensor_menu"    // Alarm sensor
"dyn_pbx_option" // System options / Main menu
"pbx_server_menu" // Server menu
"pbx_options"    // System Options
"gappp_call_forward" // Call diversion
"pbx_call_routing" // Call routing
"pbx_dnd"        // Call protection
"pbx_presence"   // Presence
"locating_editor" // Locating
"pbx_take"       // Take call
"pbx_unpark"     // Unpark call
"pbx_park"       // Park/Pickup
"gappp_pickup"   // Pickup call
"pbx_fkeys"      // XML Applications
"f_1"           // App 1
"f_2"           // App 2
"f_3"           // App 3
"f_4"           // App 4
"f_5"           // App 5
"f_6"           // App 6
"f_7"           // App 7
"f_8"           // App 8
"f_9"           // App 9
"f_10"          // App 10
"gappp_door"     // Door opener
"gappp_door1"    // Door 1
"gappp_door2"    // Door 2
```

```
"gappp_pickup_select" // Pickup select
"gappp_announcement" // Announcement
"gappp_intercom" // Intercom
"gappp_vip_call" // VIP call
"suppress_no" // Suppress no on/off
"sel_line" // Select line
"line_1" // L1
"line_2" // L2
"line_3" // L3
"line_4" // L4
"line_5" // L5
"line_6" // L6
"line_7" // L7
"line_8" // L8
"line_9" // L9
"line_10" // L10
"sk_dyn1" // <dynamic soft-key>
"opt" // Call options
"add_to" // Add to... (VIP-, Filter-list, Personal directory)
"filter" // Call filter list
"opt_called_lines" // Called lines
"dial_r" // (R) Register recall
"opt_ect" // Transfer call
"opt_deflect" // Deflect call
"opt_ccbs" // Callback CCBS
"opt_ccnr" // Callback CCNR
"opt_mcid" // Intercept MCID
"opt_receive" // Receive call
"opt_reject" // Reject call
"opt_int" // DECT intern
"opt_brokering" // Brokering
"opt_hold" // Hold call
"opt_3pty" // Conference start/stopp
"opt_record" // Recording start/stopp
"opt_retrieve" // Retrieve call in hold
"opt_privious" // Previous call
"opt_release" // Release call
"rel" // Release call / Hook on
"pbx_park" // Park call/Unpark call
"opt_booking_no" // Booking no
"vol_up" // Volume +
"vol_down" // Volume -
"mute" // Microphone on/off
"bt_toggle" // Transfer BT <-> Handset
```

## 10.5 PROTOCOLS AND PORTS

Protocol		OpenMobility Manager	
		Server port	Client port
HTTPS server	tcp server	443 or as configured	any
HTTP server (redirect to https)	tcp server	80 or as configured	any
HTTP/HTTPS client for the SIP-DECT XML terminal interface	tcp	80/443	> 1024
RFP control protocol	tcp server	16321	any
OMM Standby	tcp server	16322	any
OM AXI	tcp server	12622	any
DECTnet monitor	tcp server	8106	any
LDAP	tcp client	389 or as configured	>=1024 (see note)
TFTP client	udp	69 / given by server	>=1024 (see note)
HTTP client	tcp	80 or as configured	>=1024 (see note)
HTTPS client	tcp	443 or as configured	>=1024 (see note)
explicit FTPS client	tcp	21 or as configured	>=1024 (see note)
implicit FTPS client	tcp	990 or as configured	>=1024 (see note)
OM AXI server TCP	tcp server	12621	Any
OM AXI server TLS	tcp server	12622	Any
SIP	udp	5060	as configured
Integrated Conference Server (ICS)	udp	5062	as configured
Telnet (OMM console, Linux server based OMM only)	tcp server	localhost 8107	localhost any

**Note:** Unbound ports start at port 1024.

Protocol		IP-RFP	
		Server port	Client port
HTTP/HTTPS client for the SIP-DECT XML terminal interface	tcp	80/443	> 1024
RFP control protocol	tcp client	16321	>=1024 (see note)
HTTP server (redirect to OMM web server (http))	tcp server	80 or as configured	Any
SSH server	tcp server	22	Any
DHCP client	udp	67	68

Protocol		IP-RFP	
		Server port	Client port
TFTP client	udp	69 / given by server	>=1024 (see note)
OMCFG server	udp	64000	64000
NTP client	udp	123	123
Syslog client	udp	514 or as configured	514
DNS client	udp	53	>=1024 (see note)
SNMP agent (server)	udp	161	Any
SNMP trap agent (client)	udp	>=1024 (see note)	162
RSXport (debug only)	tcp server	38477	Any
RTP/RTCP (server)	udp	Range of [RTP port base + 71] even ports for RTP, odd ports for RTCP. Port base is 16320 or as configured.	Any
RTP/RTCP (client)	udp	any	Range of [RTP port base + 71] even ports for RTP, odd ports for RTCP. Port base is 16320 or as configured.
Integrated Conference Server (ICS) RTP/RTCP (server)		Range of [ICS RTP port base + 2 * no. conf. channels] even ports for RTP, odd ports for RTCP. ICS Port base is end of RTP range plus 1.	Any
Integrated Conference Server (ICS) RTP/RTCP (client)		any	Range of [ICS RTP port base + 2 * no. conf. channels] even ports for RTP, odd ports for RTCP. ICS Port base is end of RTP range plus 1.
Network Analysis Probe	tcp server	18215	Any

**Note:** Unbound ports start at port 1024.

## 10.6 ABBREVIATIONS

AC	Authentication Code
ADPCM	Adaptive Differential Pulse Code Modulation
COA	Configuration Over Air
DECT	Digital Enhanced Cordless Telecommunication
DHCP	Dynamic Host Configuration Protocol
DSP	Digital Signal Processor
FCC	Federal Communications Commission
GAP	Generic Access Profile
IMA	Integrated Messaging and Alerting Service
IPBX	IP PBX, a telephony system using IP / VoIP
IPEI	International Portable Equipment Identity
OM	OpenMobility
OM AXI	OM Application XML Interface
OMC	OM Configurator
OML	OM Locating
OMM	OpenMobility Manager
OMP	OM Management Portal
PARK	Portable Access Rights Key
PBX	Private Branch Exchange, a customer premises telephony system
PP	Portable Part (DECT phone or device)
RCS	Redirection and Configuration Service
RFP	Radio Fixed Part (DECT base station)
RTCP	Real Time Control Protocol
RTP	Real Time Protocol
TFTP	Trivial File Transfer Protocol

## 10.7 DEFINITIONS

Asterisk	Asterisk is a complete Open Source PBX in software. It runs on Linux, BSD and MacOSX and provides many features. Asterisk supports voice over IP in many protocols, and can interoperate with almost all standards-based telephony equipment.
Base station	Please see: RFP or Radio Fixed Part
DECT	<p><b>D</b>igital <b>E</b>nhanced <b>C</b>ordless <b>T</b>elecommunication</p> <p>The standard (ETS 300 175) essentially specifies the air interface, known as the radio interface. Voice and data can both be transmitted via this interface. Its technical key characteristics for Europe are:</p> <p>Frequency range: approx. 1880 – 1900 MHz (approximately 20 MHz bandwidth)</p> <p>carrier frequencies (1728 kHz spacing) with 12 time slots each</p> <p>Doubling the number of time slots (to 24) using the TDMA process</p> <p>Net data rate per channel of 32 kbps (for voice transmission using ADPCM)</p> <p>Voice coding using the ADPCM method</p> <p>Its technical key characteristics for North American are:</p> <p>Frequency range: approx. 1920 – 1930 MHz (approximately 10 MHz bandwidth)</p> <p>5 carrier frequencies (1728 kHz spacing) with 12 time slots each</p> <p>Doubling the number of time slots (to 24) using the TDMA process</p> <p>Net data rate per channel of 32 kbps (for voice transmission using ADPCM)</p> <p>Voice coding using the ADPCM method</p>
GAP	<p><b>G</b>eneric <b>A</b>ccess <b>P</b>rofile</p> <p>The GAP standard (ETS 300 444) is based on the same technology as DECT, but is limited to the most important basic features. This standard was created in order to allow telephones of different vendors to be used on any type of DECT system. It thus represents the smallest common denominator of all manufacturer-specific variants of the DECT standard.</p> <p>An important limitation in the GAP standard is that external handover is not possible. For this reason connection handover is used, which is supported by GAP terminals.</p> <p>The operation of GAP-capable telephones is comparable to that of analogue terminals. For example, features can be called up via '*' and '#' procedures.</p>
Handover	A handover is similar to roaming, but occurs during an ongoing call. A handover normally takes place "in the background", without disrupting the call (seamless handover).

IPEI	<p><b>International Portable Equipment Identity</b>          13-digit identification code for DECT phones          Example: 00019 0592015 3          (the final digit is the checksum).          The code is represented in decimal form.          This code is globally unique.</p>
PARK	<p><b>Portable Access Rights Key</b>          Access code for the Portable Part. This code determines whether a DECT phone can access a particular DECT system. Used for unique selection of a dedicated the system from a DECT phone at enrolment/subscription time. Provided via the PARK online service and unique to each SIP-DECT deployment.</p>
Radio Fixed Part (RFP)	<p>An RFP provides a DECT radio cell and terminates the radio link from the portable DECT device. One or more RFPs build the area of radio coverage.</p>
Roaming	<p>While in motion, the DECT phone performs ongoing measurements to determine which RFP is best received. The one that can be best received is defined as the active RFP. To prevent the DECT phone from rapidly switching back and forth between two RFPs that have similar signal strength, certain threshold values are in effect.</p>



## 10.8 REFERENCES

- /1/ RFC 1350, The TFTP Protocol, Revision 2, July 1992
- /2/ RFC 2090, TFTP Multicast Option, February 1997
- /3/ RFC 2347, TFTP Option Extension, May 1998
- /4/ RFC 2348, TFTP Block size Option, May 1998
- /5/ RFC 2349, TFTP Timeout Interval and Transfer Size Options, May 1998
- /6/ RFC 2236, Internet Group Management Protocol, Version 2, November 1997
- /7/ RFC 1889, RTP: A Transport Protocol for Real-Time Applications, January 1996
- /8/ RFC 2030, Simple Network Time Protocol (SNTP) Version 4 for IPv4, IPv6 and OSI, October 1996
- /9/ RFC 2131, Dynamic Host Configuration Protocol, March 1997
- /10/ RFC 2327, SDP: Session Description Protocol, April 1998
- /11/ RFC 2474, Definition of the Differentiated Service Field (DS Field) in the IPv4 and IPv6 Headers, December 1998
- /12/ RFC 2617, HTTP Authentication: Basic and Digest Access Authentication, June 1999
- /13/ RFC 3164, The BSD Sys Log Protocol, August 2001
- /14/ RFC 2833, RTP Payload for DTMF Digits, Telephony Tones and Telephony Signals, May 2000
- /15/ RFC 3261, Session Initiation Protocol (SIP), June 2002
- /16/ RFC 3264, An Offer/Answer Model with Session Description Protocol (SDP), June 2002
- /17/ RFC 3326, The Reason Header Field for SIP, December 2002
- /18/ RFC 3420, Internet Media Type message/sipfrag, November 2002
- /19/ RFC 3515, The Session Initiation Protocol (SIP) Refer method, April 2003
- /20/ RFC 3665, The Session Initiation Protocol (SIP) Basic Call Flow Examples, December 2003
- /21/ RFC 3842, A Message Summary and Message Waiting Indication Event Package for the Session Initiation Protocol (SIP), August 2004
- /22/ RFC 3891, The Session Initiation Protocol (SIP) "Replaces" Header, September 2004
- /23/ RFC 3892, The Session Initiation Protocol (SIP) Referred-By Mechanism, September 2004
- /24/ RFC 4566, SDP: Session Description Protocol
- /25/ RFC 5806, Diversion Indication in SIP, March 2010
- /26/ Compendium "OpenMobility SIP-DECT 4.0 Solution; Installation & Administration"
- /27/ SIP-DECT; OM Locating Application; Installation, Administration & User Guide
- /28/ SIP-DECT; OM Integrated Messaging & Alerting Application; Installation, Administration & User Guide
- /29/ SIP-DECT; OM Handset Sharing & Provisioning; User Guide
- /30/ SIP-DECT; OM User Monitoring; User Guide
- /31/ SIP-DECT; Mitel 600 ; Messaging & Alerting Applications; User Guide
- /32/ Mitel 600 series SIP-DECT User's Guide
- /33/ aad-0384 SIP\_DECT OM Application XML Interface
- /34/ RFC 2782, A DNS RR for specifying the location of services (DNS SRV)
- /35/ RFC 3262, Reliability of Provisional Responses in the Session Initiation Protocol (SIP)

- /36/ RFC 3311, The Session Initiation Protocol (SIP) UPDATE Method
- /37/ req-0175 SIP-DECT XMLTerminal Interface for Mitel 600 DECT Phone Family
- /38/ RFC 4579, Session Initiation Protocol (SIP) Call Control - Conferencing for User Agents
- /39/ RFC 5589, Session Initiation Protocol (SIP) Call Control – Transfer
- /40/ RFC 2246, The TLS Protocol Version 1.0
- /41/ RFC 2459, Internet X.509 Public Key Infrastructure certificate
- /42/ RFC 3711, The Secure Real-Time Transport Protocol (SRTP)
- /43/ RFC 4346, The Transport Layer Security (TLS) Protocol Version 1.1
- /44/ RFC 4568, Session Description Protocol (SDP); Security Description for Media Streams
- /45/ RFC 5246, The Transport Layer Security (TLS) Protocol Version 1.2
- /46/ RFC 5630, The Use of the SIPS URI Scheme in the Session Initiation Protocol (SIP)



**Mitel.com**

© Copyright 2015, Mitel Networks Corporation. All Rights Reserved. The Mitel word and logo are trademarks of Mitel Networks Corporation. Any reference to third party trademarks are for reference only and Mitel makes no representation of ownership of these marks.